



TX408 TX412

TX410 TX415

User Guide

(1.0) INTRODUCTION 3

 (1.1) Box Contents 3

 (1.2) Support 3

(2.0) SETUP 4

 (2.1) Important Safety Precautions 4

 (2.1.1) Stand Mounting 4

 (2.1.2) Sound Level 4

 (2.2) Setup 5

 (2.2.1) System Power Sequencing 5

 (2.2.2) Connection Diagrams 6

(3.0) FEATURES 8

 (3.1) Rear Panel 8

(4.0) OPERATION 10

 (4.1) Pairing a Bluetooth® Device 10

 (4.2) Stereo-Link™: Connecting Two Speakers 10

(5.0) TROUBLESHOOTING 11

(6.0) APPENDIX 12

 (6.1) Technical Specifications 12

 (6.2) Trademarks & Licenses 19

Thank you for purchasing the TX4 series speaker. At Alto Professional, performance and reliability mean as much to us as they do to you. We design our equipment with only one thing in mind—to make your performance the best it can be.

(1.1) Box Contents

TX4 Series Speaker
Power Cable (6 ft. / 183 cm)
Quickstart Guide
Safety & Warranty Manual

(1.2) Support

For the latest information about this product (system requirements, compatibility information, etc.) and product registration, visit altoprofessional.com.

For additional product support, visit altoprofessional.com/support.

(2.1) Important Safety Precautions

Please note: Alto Professional and inMusic are not responsible for the use of its products or the misuse of this information for any purpose. Alto Professional and inMusic are not responsible for the misuse of its products caused by avoiding compliance with inspection and maintenance procedures. Please also refer to the included safety and warranty manual for more information.

(2.1.1) Stand Mounting

Important: Do **not** suspend a TX4 series loudspeaker. It is not designed for suspended applications.

- Always install loudspeakers in accordance with applicable electrical and building codes.
- Install the loudspeaker according to its maximum weight. Check the specifications of your stand or pole to ensure it can support the loudspeaker's weight.
- Observe all safety precautions specified by the stand manufacturer.
- Do **not** mount multiple loudspeakers on the same stand or pole.
- Always verify that the stand or pole is on a flat, level, and stable surface.
- Always be cautious in windy, outdoor conditions. Do not attach anything to the loudspeaker other than cables or equipment necessary for standard operation.
- Unless you are confident that you can handle the loudspeaker's weight, ask another person to help you lift it onto the stand or pole.
- Make sure your cables are out of the way of performers, production crew, and audience.

(2.1.2) Sound Level

Permanent hearing loss may be caused by exposure to extremely high noise levels. The U.S. Occupational Safety and Health Administration (OSHA) has specified permissible exposures to certain noise levels. According to OSHA, exposure to high sound pressure levels (SPL) in excess of these limits may result in hearing loss. When using equipment capable of generating high SPL, use hearing protection while such equipment is under operation.

Hours per day	SPL (dB)	Example
8	90	Small gig
6	92	Train
4	95	Subway train
3	97	High-level desktop monitors
2	100	Classical music concert
1.5	102	Riveting machine
1	105	Machine factory
0.5	110	Airport
0.25 or less	115	Rock concert

(2.2) Setup

(2.2.1) System Power Sequencing

Proper power sequencing will help prevent audible thumps, clicks, and other noises in the system.

Note: Read the *Safety & Warranty Manual* before using TX4 series loudspeaker.

1. Turn down the output level controls on your audio sources and processors (CD players, mixers, etc.) and power them on.
2. Set the **Volume** knob to the zero position on the TX4 series loudspeaker.
3. Turn on your loudspeakers.
4. Bring up the faders or level controls on your mixer and start playing your audio source.
5. Raise the **Volume** knob on the TX4 series loudspeaker to a comfortable level.

When powering off:

1. Set the TX4 series loudspeaker **Volume** knob to the zero position.
2. Power off the subwoofer.
3. Turn off all audio source devices and processors.

(2.2.2) Connection Diagrams

Items not listed under [Introduction > Box Contents](#) are sold separately.

Example A: Two Loudspeakers

Connect each of your mixer's main outputs to the **input** on a TX4 loudspeaker. Make sure the **input selectors** are set to **Line**.

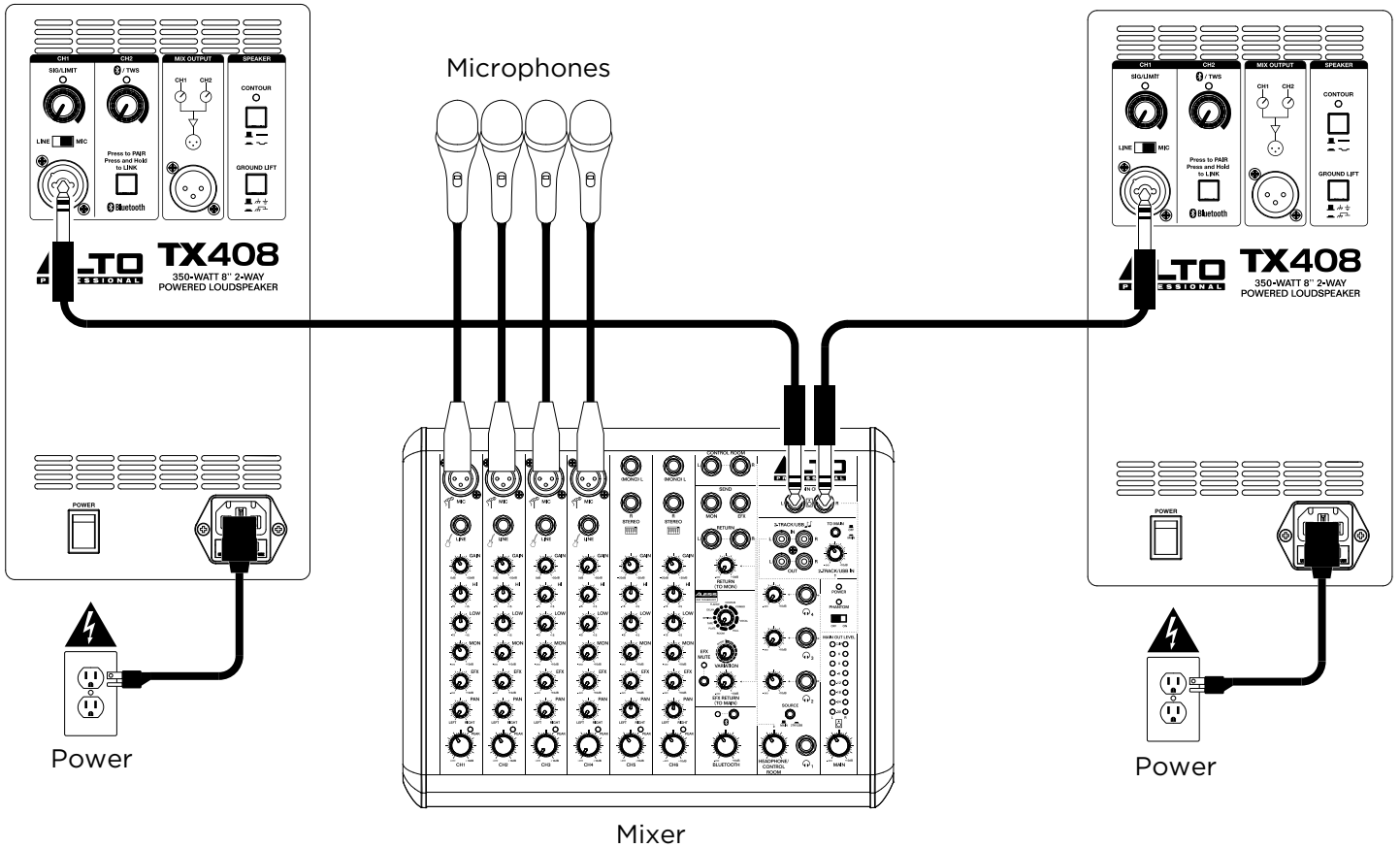

Example B: Two loudspeakers + Two Subs

Connect each of your mixer's main outputs to the **input** on a TX4 loudspeaker. Make sure the **input selectors** are set to **Line**. Connect each of your TX4 loudspeakers' **mix outs** to the inputs of your subs.

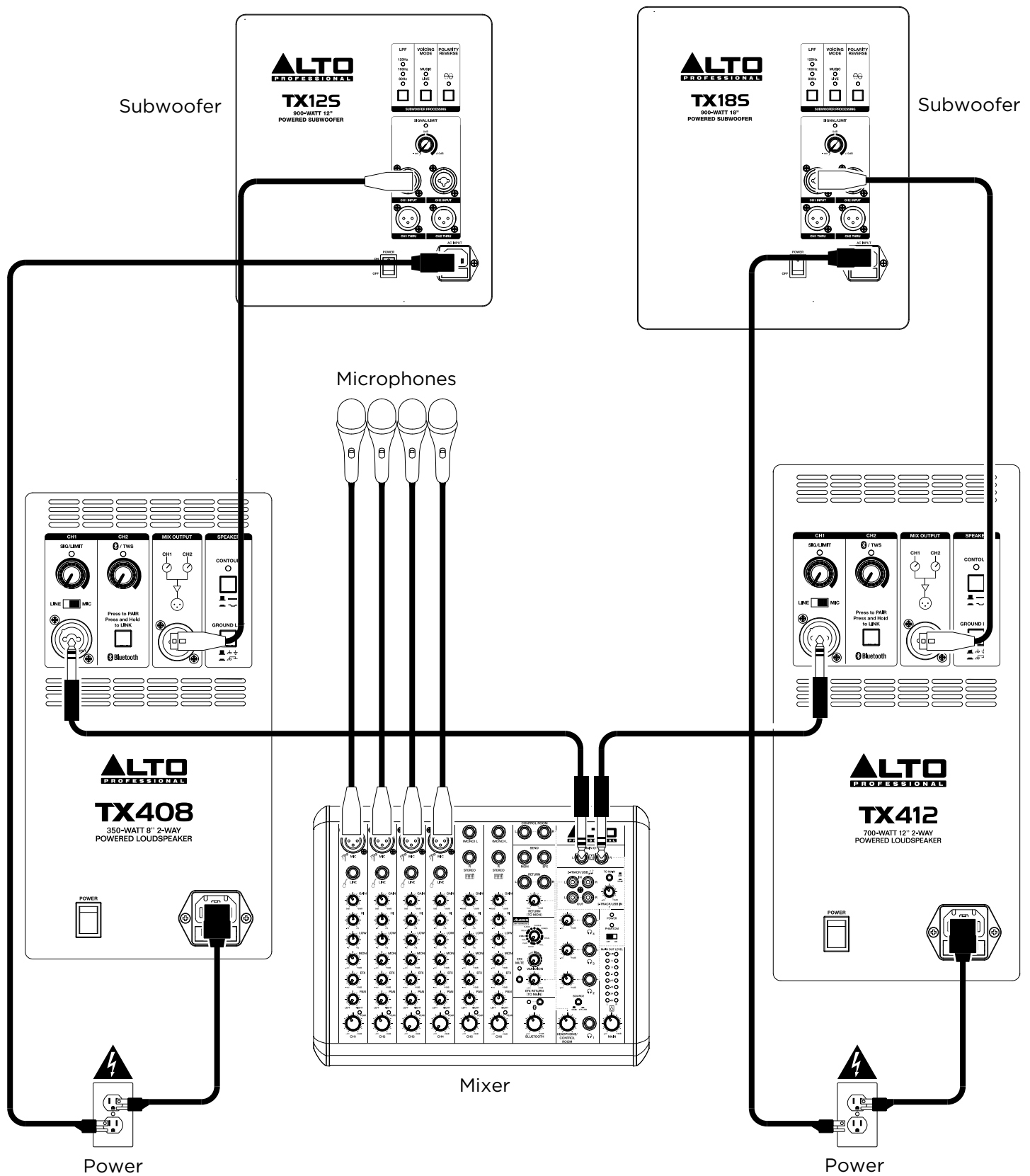

(3.1) Rear Panel

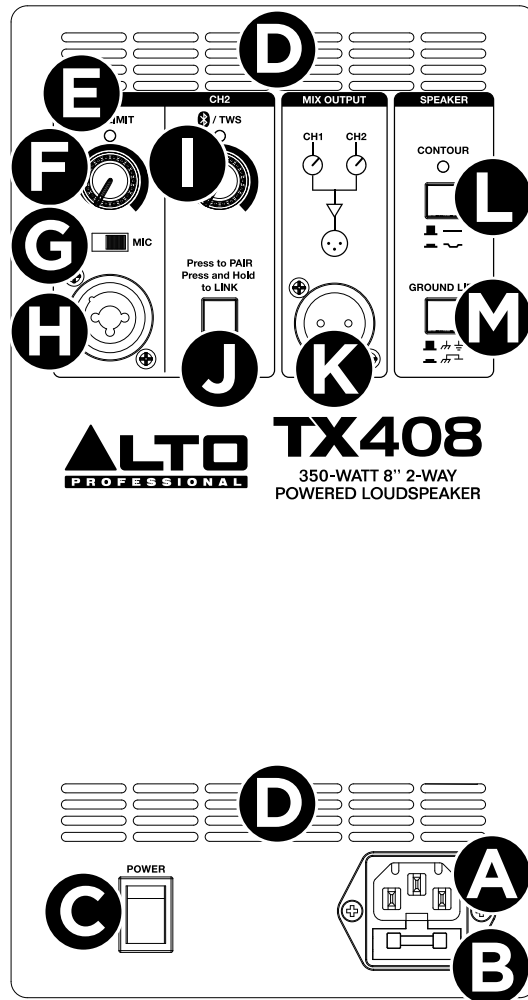

A. Power

Use the included power cable to connect this input to a power outlet. Make sure the **Power Switch** is set to off when connecting or disconnecting the cable.

B. Fuse

If the unit's fuse is broken, lift this tab to replace the fuse. Replace it with a fuse with an appropriate rating (printed next to the unit's power cable input). Using a fuse with an incorrect rating can damage the unit and/or fuse.

C. Power Switch

Use this switch to power the loudspeaker on or off. Make sure the **Volume** knob is set to its minimum (counterclockwise) position before turning it on.

D. Cooling Vent

Keep the area in front of this vent clear from obstructions.

E. Signal/Limit LED

This light illuminates when a high audio signal level activates the internal protection circuit. The protection circuit dynamically reduces the signal level to avoid audible distortion and to protect the woofer and high-frequency driver from over-excursion or mechanical damage. If this light is lit constantly, or the sound is distorted, reduce the signal level of your sound source, or lower the channel's **Volume** knob.

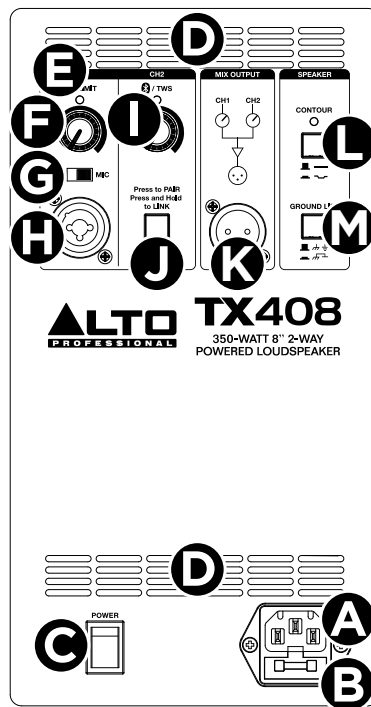

F. Channel 1 Volume

Turn this knob to adjust the input gain of Channel 1.

G. Input Selector

Set this switch to the **Line** position when using a line-level audio source connected to the **Channel 1 Input**. Set this switch to the **Mic** position when using a microphone connected to the **Channel 1 Input**.

H. Channel 1 Input (1/4" [6.35 mm] / XLR)

Use a standard XLR or 1/4" (6.35 mm) TRS cable (not included) to connect your audio source to this input. Make sure to set the **Input Selector** switch to the correct position.

I. Channel 2/Bluetooth Volume

Turn this knob to adjust the input gain of the connected Bluetooth device. Make sure your device volume is turned all the way up before adjusting this volume.

J. Bluetooth/TWS Link

Press this button to pair Bluetooth devices and wirelessly link two speakers. See the section [Pairing a Bluetooth® Device](#) and [Stereo-Link™: Connecting Two Speakers](#) for more details.

K. Mix Out (XLR)

Use a standard XLR cable (not included) to connect this output to the input of another loudspeaker (i.e., another TX4 loudspeaker). This output sends the combined signal of Channel 1 and Channel 2.

L. Contour

Engage (depress) this button to emphasize low and high frequencies by +3 dB. Disengage (raise) the switch for a flatter response for live performance or for maximum output.

M. Ground Switch

Engage (depress) this switch to reduce hum or noise.

(4.1) Pairing a Bluetooth® Device

1. Make sure your device is powered on and within range (no more than 100 ft. [30.5 m]) of your speaker.
2. Press the **Bluetooth/TWS Link** button on the TX4 series speaker. It will enter pairing mode and the **CH2 LED** will flash green.
3. Navigate to your device's Bluetooth setup screen, and then find and select your TX4 series loudspeaker from the list of devices (for example, "TX408"). If your Bluetooth device prompts for a pairing code, enter 0000. If there is no connection after 90 seconds, the speaker will exit pairing mode.
4. When paired successfully, the **CH2 LED** will be solid green. Once you have previously connected a Bluetooth device, the speaker will reconnect to it automatically in pairing mode if it is within range and available for pairing.

To disconnect a paired device, return to your device's Bluetooth setup screen and select Disconnect.



(4.2) Stereo-Link™: Connecting Two Speakers

To wirelessly link two TX4 series TWS-compatible speakers for stereo Bluetooth playback:

1. Make sure both speakers are powered on and within range (75 ft. [23 m]) of one another, and that you have already paired your Bluetooth device to one speaker using the directions above.
2. Press and hold the **Bluetooth/TWS Link** button on one speaker until the **CH2 LED** starts to flash yellow, indicating it is in Stereo Link™ mode.
3. Repeat this on a second speaker, and the two will begin searching for a link. It may take up to one minute for the speakers to link.
4. Once a connection is made, both speakers' **CH2 LEDs** will be solid yellow. On the speaker that is connected to your Bluetooth device, the LED will turn green after five seconds. You can now stream Bluetooth audio wirelessly between the two speakers.

To unlink, double-press the **Bluetooth/TWS Link** button on either speaker.



First Speaker



Second Speaker



First Speaker:
Press and hold



Second Speaker:
Press and hold



If the sound is distorted: Try lowering the volume control of your sound source, musical instrument, or microphone. Also, try to reduce the channel volume on the speaker using the channel's **Volume** knob.

I hear a hum when cables are connected:

- Disconnect cables from the input jacks to see if it's a faulty cable.
- Use balanced cabling connections whenever possible.
- Make sure the signal cables are not placed near power cables.
- Connect all audio equipment power cables to outlets which share a common ground.

If there is a high-pitched whistling noise when using microphones: This is probably feedback. Point the microphone away from the speaker.

If you can't hear the microphone over the music volume: Turn down the music volume from your source.

If you can't hear your instrument: Check that the **INST/LINE switch** is set to **INST**.

If you cannot connect your audio device to your TX4 speaker via Bluetooth:

- Have your audio device (e.g., smartphone or tablet) and the TX4 speaker as close together as possible while trying to connect. Make sure both the audio device and the speaker are unobstructed by walls, furniture, etc.
- Reset the Bluetooth connection on your audio device by turning Bluetooth off and back on. You can find this under the Bluetooth menu in the Settings for your phone or other audio device.

If this does not work, and you have connected to the speaker before, find it in the list of available or previously connected devices in your audio device's Bluetooth menu, tap the "gear" or "i" icon located next to it and then select **Unpair** or **Forget**. Turn the TX4 speaker off and back on and try pairing again once it reappears in your available devices list.

Note: If the TX4 speaker has been paired to another audio device recently that is still within range, you may need to repeat this process with that audio device to fully disconnect.

If you are having issues connecting two speakers using Stereo-Link™:

- Double press the **Bluetooth/TWS Link** button to unlink the speakers, and restart the **Stereo-Link™** process.

(6.1) Technical Specifications

Specifications are subject to change without notice.

TX408

Mic Input CH 1	
Connector	XLR/TRS Combo Input Connector (mic is XLR only)
Dynamic Range	108 dB (A-Weighted)
THD +N	<0.01%
Noise EIN	>-110 dB (A-Weighted)
Maximum Input Level	+1.5 dBu
Gain Range	50 dB
Frequency Response	20 Hz - 20 kHz (+/- 0.1 dB)
Input Impedance	600 Ω
Line Inputs CH 1	
Connector	XLR/TRS combo input connector (line is TRS only)
Dynamic Range	108 dB (A-Weighted)
THD +N (% , -1 dBFS input)	<0.01%
Maximum Input Level	+16 dBu
Gain Range	24 dB
Frequency Response (20 Hz - 20 kHz)	20 Hz - 20 kHz (+/- 0.1 dB)
Input Impedance	20k Ω
Mix Out	
Connector	XLR output connector
Frequency Response	20 Hz - 20 kHz (+/- 0.1 dB)
Output Level (for 0.5% THD)	Fixed +10 dBu
Input Impedance (unbalanced)	100 Ω
General	
System Type	2-way active ported loudspeaker
Drivers	Low-Frequency: 8.0" (203 mm) driver, 1.4" (35.5 mm) voice coil High-Frequency: 1.0" (25 mm) titanium-diaphragm compression driver, 1.0" (25 mm) voice coil
Amplifier	300 watts (peak), Class D power
Horn Coverage	90° horizontal x 60° vertical (nominal)
Signal-to-noise ratio	>100 dB

General (continued)	
Frequency Response	75 Hz - 20 kHz (-3 dB)
Max SPL	114 dB @ 1 m
Equalization	Contour switch with low- and high-frequency +3 dB boost
Connectors	(1) XLR/TRS input (Line/Mic) (1) XLR/TRS output (1) IEC power cable input
Controls	Power switch, channel volume control knobs
Indicators	Clip limiter LED
Bluetooth	Version: 5.0 Profiles: A2DP, AVRCP
Power	Connection: IEC Voltage: 100-240 V, 50/60 Hz Fuse: T2AL/250V Consumption: 150W
Protection	Thermal, overload analog limiter/compressor
Enclosure	Injection-molded polypropylene, multi-angle for main or monitor applications, metal grille, rubber feet, 1 handle on top
Mounting/Installation	Standard 36 mm pole socket, wedge monitor
Dimensions (height x width x depth)	16.6" x 10.7" x 9.9" 422 x 272 x 251 mm
Weight	13.0 lb 5.9 kg

TX410

Mic Input CH 1	
Connector	XLR/TRS combo input connector (mic is XLR only)
Dynamic Range	108 dB (A-Weighted)
THD +N	<0.01%
Noise EIN	>-110 dB (A-Weighted)
Maximum Input Level	+1.5 dBu
Gain Range	50 dB
Frequency Response	20 Hz - 20 kHz (+/- 0.1 dB)
Input Impedance	600 Ω
Line Inputs CH 1	
Connector	XLR/TRS combo input connector (line is TRS only)
Dynamic Range	108 dB (A-Weighted)
THD +N (% , -1 dBFS input)	<0.01%
Maximum Input Level	+16 dBu
Gain Range	24 dB
Frequency Response (20 Hz - 20 kHz)	20 Hz - 20 kHz (+/- 0.1 dB)
Input Impedance	20k Ω
Mix Out	
Connector	XLR output connector
Frequency Response	20 Hz - 20 kHz (+/- 0.1 dB)
Output Level (for 0.5% THD)	Fixed +10 dBu
Input Impedance (unbalanced)	100 Ω
General	
System Type	2-way active ported loudspeaker
Drivers	Low-Frequency: 10.0" (254 mm) driver, 1.4" (35.5 mm) voice coil High-Frequency: 1.0" (25 mm) titanium-diaphragm compression driver, 1.0" (25 mm) voice coil
Amplifier	300 watts (peak), Class D power
Horn Coverage	90° horizontal x 60° vertical (nominal)
Frequency Response	75 Hz - 20 kHz (-3 dB)
Max SPL	117 dB @ 1 m

General (continued)	
Equalization	Contour switch with low- and high-frequency +3 dB boost
Connectors	(1) XLR/TRS input (Line/Mic) (1) XLR/TRS output (1) IEC power cable input
Controls	Power switch, volume control knob
Indicators	Clip limiter LED
Bluetooth	Version: 5.0 Profiles: A2DP, AVRCP
Power	Connection: IEC Voltage: 100-240 V~; 50/60 Hz Fuse: T2AL/250V Consumption: 150W
Protection	Thermal, overload analog limiter/compressor
Enclosure	Injection-molded polypropylene, multi-angle for main or monitor applications, metal grille, rubber feet, 1 handle on top
Mounting/Installation	Standard 36 mm pole socket, wedge monitor
Dimensions (height x width x depth)	18.2" x 11.2" x 11.0" 462 x 284 x 279 mm
Weight	15.0 lb 6.8 kg

TX412

Mic Input CH 1	
Connector	XLR/TRS combo input connector (mic is XLR only)
Dynamic Range	108 dB (A-Weighted)
THD +N	<0.01%
Noise EIN	>-110 dB (A-Weighted)
Maximum Input Level	+1.5 dBu
Gain Range	50 dB
Frequency Response	20 Hz - 20 kHz (+/- 0.1 dB)
Input Impedance	600 Ω
Line Inputs CH 1	
Connector	XLR/TRS Combo Input Connector (line is TRS only)
Dynamic Range	108 dB (A-Weighted)
THD +N (% , -1 dBFS input)	<0.01%
Maximum Input Level	+16 dBu
Gain Range	24 dB
Frequency Response (20 Hz - 20kHz)	20 Hz - 20 kHz (+/- 0.1 dB)
Input Impedance	20k Ω
Mix Out	
Connector	XLR output connector
Frequency Response	20 Hz - 20 kHz (+/- 0.1 dB)
Output Level (for 0.5% THD)	Fixed +10 dBu
Input Impedance (unbalanced)	100 Ω

General	
System Type	2-way active ported loudspeaker
Drivers	Low-Frequency: 12.0" (305 mm) driver, 2.0" (51 mm) voice coil High-Frequency: 1.0" (25 mm) titanium-diaphragm compression driver, 1.0" (25 mm) voice coil
Amplifier	700 watts (peak), Class D power
Horn Coverage	90° horizontal x 60° vertical (nominal)
Frequency Response	70 Hz - 20 kHz (-3 dB)
Max SPL	120 dB @ 1 m
Equalization	Contour switch with low- and high-frequency +3 dB boost
Connectors	(1) XLR/TRS input (Line/Mic) (1) XLR/TRS output (1) IEC power cable input
Controls	Power switch, volume control knob, contour switch, ground-lift switch
Indicators	(2) power LEDs (1 front panel, 1 rear panel), clip limiter LED
Bluetooth	Version: 5.0 Profiles: A2DP, AVRCP
Power	Connection: IEC Voltage: 100-120V~, 50/60 Hz; 220-240V~, 50/60 Hz Fuse: 100-120V T6.3AL AC250V; 220-240V T3.15AL AC250V Consumption: 350W
Protection	Thermal, overload analog limiter/compressor
Enclosure	Injection-molded polypropylene, multi-angle for main or monitor applications, metal grille, rubber feet, 2 handles (both sides)
Mounting/Installation	Standard 36 mm pole socket, wedge monitor
Dimensions (height x width x depth)	23.7" x 15.0" x 13.5" 602 x 381 x 343 mm
Weight	29.3 lb 13.3 kg

TX415

Mic Input CH 1	
Connector	XLR/TRS combo input connector (mic is XLR only)
Dynamic Range	108 dB (A-Weighted)
THD +N	<0.01%
Noise EIN	>-110 dB (A-Weighted)
Maximum Input Level	+1.5 dBu
Gain Range	50 dB
Frequency Response	20 Hz - 20 kHz (+/- 0.1 dB)
Input Impedance	600 Ω
Line Inputs CH 1	
Connector	XLR/TRS combo input connector (line is TRS only)
Dynamic Range	108 dB (A-Weighted)
THD +N (% , -1 dBFS input)	<0.01%
Maximum Input Level	+16 dBu
Gain Range	24 dB
Frequency Response (20 Hz - 20 kHz)	20 Hz - 20 kHz (+/- 0.1 dB)
Input Impedance	20k Ω
Mix Out	
Connector	XLR output connector
Frequency Response	20 Hz - 20 kHz (+/- 0.1 dB)
Output Level (for 0.5% THD)	Fixed +10 dBu
Input Impedance (unbalanced)	100 Ω
General	
System Type	2-way active ported loudspeaker
Drivers	Low-Frequency: 15.0" (381 mm) driver, 2.0" (51 mm) voice coil High-Frequency: 1.0" (25 mm) titanium-diaphragm compression driver, 1.0" (25 mm) voice coil
Amplifier	700 watts (peak), Class D power
Horn Coverage	90° horizontal x 60° vertical (nominal)
Frequency Response	65 Hz - 20 kHz (-3 dB)
Max SPL	121 dB @ 1 m

General (continued)	
Connectors	(1) XLR/TRS input (Line/Mic) (1) XLR/TRS output (1) IEC power cable input
Controls	Power switch, volume control knob, contour switch, ground-lift switch
Indicators	Clip limiter LED
Bluetooth	Version: 5.0 Profiles: A2DP, AVRCP
Power	Connection: IEC Voltage: 100-120V~, 50/60 Hz; 220-240V~, 50/60 Hz Fuse: 100-120V T6.3AL AC250V; 220-240V T3.15AL AC250V Consumption: 350W
Protection	Thermal, overload analog limiter/compressor
Enclosure	Injection-molded polypropylene, multi-angle for main or monitor applications, metal grille, rubber feet, 2 handles (both sides)
Mounting/Installation	Standard 36 mm pole socket, wedge monitor
Dimensions (height x width x depth)	24.9" x 15.2" x 14.6" 634 x 386 x 371 mm
Weight	31.7 lb 14.4 kg

Bluetooth and wireless reception and range are affected by walls, obstructions, and movement. For optimal performance, place the product in the center of the room so it is unobstructed by walls, furniture, etc. Battery life may vary based on temperature, age, and volume usage of product.

(6.2) Trademarks & Licenses

Alto Professional is a trademark of inMusic Brands, Inc., registered in the U.S. and other countries.

The *Bluetooth* word mark and logos are owned by the Bluetooth SIG, Inc. and any use of such marks by Alto Professional is under license.

All other product names, company names, trademarks, or trade names are those of their respective owners.

altoprofessional.com