

iD48

24in | 32out
Audio Interface

Manual V1.1

AUDIANT

Welcome to your new Audient iD48 Audio Interface

To help get you started please visit audient.com/products/iD48 to download the latest software and firmware.

Inside the box:

- iD48
- USB-C to USB-C cable
- Quick Start Guide
- Rack Ears
- Mains Power Cable

Features include:

- 8 x Class-A Audient Console Mic Preamps
- Class Leading AD/DA Converters
- 2 x Discrete JFET Instrument Inputs
- Main and Alt Speaker Outputs
- 2 x Independent Dual Headphone Outputs
- 2 x ADAT Inputs & Outputs
- 8 Switchable Balanced Inserts/Line Outputs
- Ultra-low Latency DSP Mixer
- Audio Loop-back
- 2 x User Defined Function Keys
- Dedicated Dim and Cut Controls
- +48V, Pad, and HPF Controls
- USB 3.0 Compliant
- 24bit/96kHz
- Word Clock Input & Output
- All-Metal Design
- Free Software + Plugins



Contents

iD48 Overview	4	DAW Setups:	49
Safety Information	5	Pro Tools Setup	50
Declaration of Conformities	7	Logic Pro Setup	51
Installation:	8	Cubase/Nuendo Setup	53
Mac Installation	9	Ableton Setup	55
Windows Installation	10	Troubleshooting & FAQ	56
iD App & Firmware Update	11	Technical Specifications	59
Hardware Features:	12	Dimensions	60
Microphone & Line Input	13	Warranty	61
Instrument Input	13	Service & Contact	62
Input Controls	14	Glossary	63
The Three ADC Path Settings	15		
Monitor Control	19		
Hardware Metering	19		
The ALT Button	19		
F-Keys	19		
Power Control	19		
Monitor Outputs	20		
Headphone Outputs	20		
ADC Inputs/Insert Returns	21		
Line Outputs/Insert Sends	21		
Digital Inputs and Outputs	22		
Word Clock Input and Output	22		
Clocking Information	22		
Rack Ear Fitting Instructions	27		
Software Features:	29		
Input Channel Types	30		
Master Section Features	33		
System Panel Features	36		
Saving & Loading Mixer Presets	45		
Store Standalone State	46		
Menu/Task Bar Icons	46		
Firmware Update	47		
Keyboard Shortcuts	48		

iD48 Overview

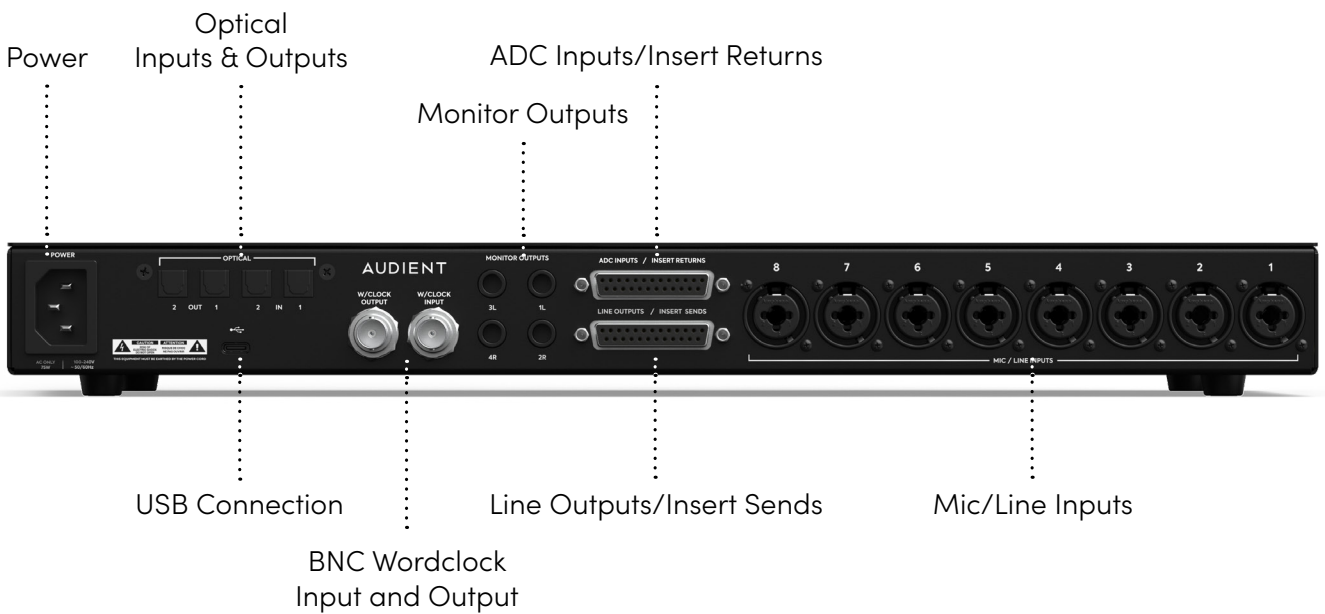
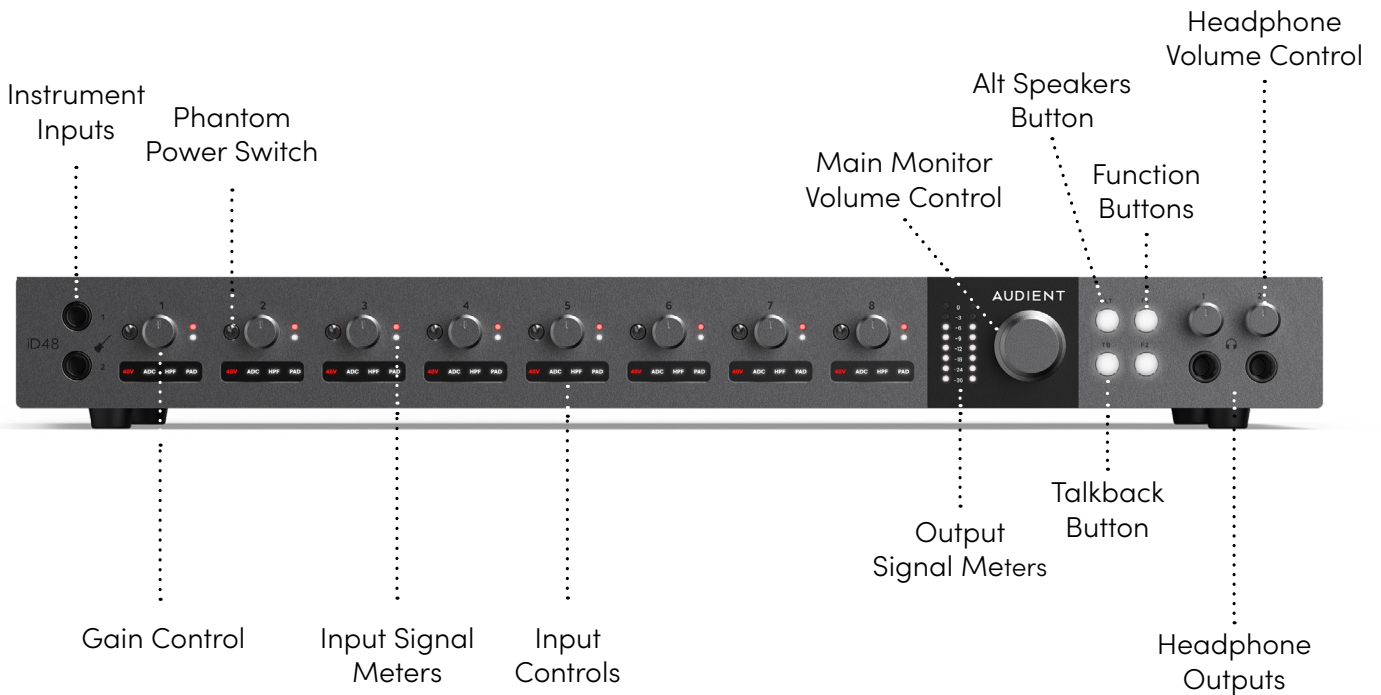

Safety Information

Important Safety Instructions

Please read all of these instructions and save them for later reference before connecting the power cable and powering up iD48.

The iD48 uses an internal switch mode power supply that will operate on AC voltages between 90V and 264V, 50-60Hz so can be used worldwide without requiring the operating voltage to be manually adjusted.

Consult a qualified technician if you suspect difficulties. Do not attempt to tamper with the power supply or mains voltages - **HAZARDOUS TO HEALTH**. To reduce risk of fire or electrical shock, DO NOT expose this apparatus to rain or moisture.

WARNING! No user serviceable parts inside. Please refer servicing to qualified service personnel. You can find more information on how repairs at audient.com/support

Safety Information

Important Safety Instructions

1. Read these instructions
2. Keep these instructions
3. Heed all warnings
4. Follow all instructions
5. Do not use this equipment near water
6. Clean only with dry cloth
7. Do not install near any heat sources such as radiators, heat registers, stoves, or other equipment (including amplifiers) that produce heat
8. Do not defeat the safety purpose of the polarized or grounding-type plug. A polarized plug has two blades with one wider than the other. A grounding type plug has two blades and a third grounding prong. The wide blade or the third prong are provided for your safety. If the provided plug does not fit into your outlet, consult an electrician for replacement of the obsolete outlet
9. Protect power cords from being walked on or pinched particularly at plugs, convenience receptacles and the point where they exit from the equipment
10. Only use attachments/accessories specified by the manufacturer
11. Unplug this equipment during lightning storms or when unused for long periods of time
12. Refer all servicing to qualified service personnel. Servicing is required when the equipment has been damaged in any way, such as power supply cord or plug is damaged, liquid has been spilled or objects have fallen into the equipment, the equipment has been exposed to rain or moisture, does not operate normally, or has been dropped
13. For products that are a mains powered device: The equipment shall not be exposed to dripping or splashing and no objects filled with liquids (such as vases) shall be placed on the equipment

Declaration of Conformities

FCC Part 15B

This apparatus has been tested and found to comply with the limits of a class-A digital device, pursuant to Part 15B of the FCC Rules. These limits are designed to provide reasonable protection against harmful interference in a residential installation. This equipment generates, uses and can radiate radio frequency energy and, if not installed and used in accordance with the instructions, may cause harmful interference to radio communications. If this equipment does cause harmful interference to radio or television reception, which can be determined by turning the equipment off and on, the user is encouraged to try to correct the interference by one or more of the following measures:

1. Re-orient or relocate the receiving antenna
2. Increase the separation between the equipment and receiver
3. Connect the equipment into an outlet on a different circuit from that to which the receiver is connected
4. Consult the dealer or an experienced radio/TV technician for help



We, Audient Ltd, Aspect House, Herriard, Hampshire, RG25 2PN, UK, 01256 381944, declare under our sole responsibility that the product iD48 complies with Part 15 of FCC Rules.

Operation is subject to the following two conditions:

1. This device may not cause harmful interference,
2. This device must accept any interference received, including interference that may cause undesired operation



We, Audient Ltd, declare that the product, the iD48, to which this declaration relates, is in material conformity with the appropriate CE standards and directives for an audio product designed for consumer use.



We, Audient Ltd, declare that the product, the iD48, to which this declaration relates, is in material conformity with the appropriate UKCA standards and directives for an audio product designed for consumer use.



Audient Ltd has conformed where applicable, to the European Union's Directive EN 63000:2018 on Restrictions of Hazardous Substances (RoHS) as well as the following sections of California law which refer to RoHS, namely sections 25214.10, 25214.10.2, and 58012, Health and Safety Code; Section 42475.2, Public Resources

Installation

macOS

1. Download the iD Software Mixer Application for Mac from audient.com/iD48/downloads

2. Open the downloaded file and drag the iD icon into the Applications folder.

3. Connect the iD48 to the Mac using the included USB-C cable. If necessary, a third-party USB-C to A cable can also be used. The device requires a connection to a USB 2.0 port or greater.

4. Run the iD Software Mixer Application from your Applications folder. To ensure your interface has the latest features, you may be asked to install a firmware update, follow the on-screen steps to do this.

5. Upon opening the iD Software Mixer Application for the first time, a Product Registration screen will appear, allowing you to register your product with Audient ARC to receive update notifications and access to exclusive plugins and software. You can also do this later if necessary.

macOS Minimum System Requirements:

macOS: 10.13.6 (High Sierra) or Later

Intel CPU or Apple Silicon

1GB RAM Minimum

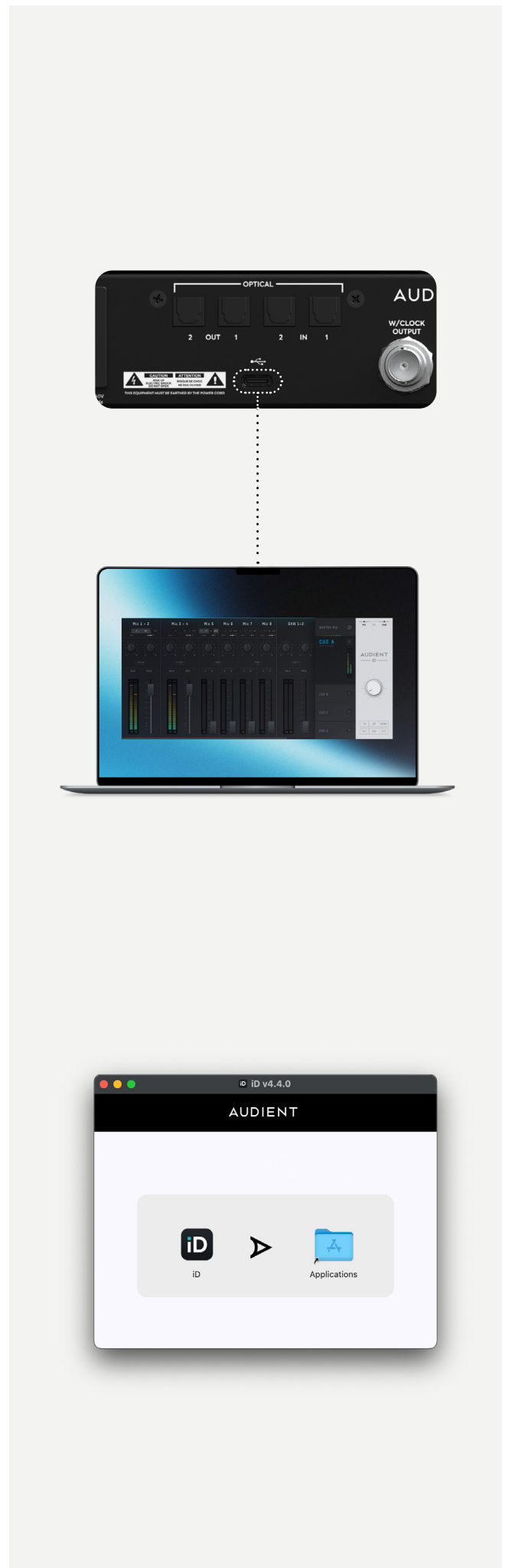

Windows

1. Download the iD Software Mixer Application for Windows from audient.com/iD48/downloads

2. Open the installer and follow the instructions shown on the screen. After installing the drivers, plug the iD48 into the PC. It can sometimes take a few moments for Windows to finalise the drivers before the unit is recognised.

3. Run the iD Software Mixer Application from your Start menu. To ensure your interface has the latest features, you may be asked to install a firmware update, follow the on-screen steps to do this.

4. Upon opening the iD Software Mixer Application for the first time, a Product Registration screen will appear, allowing you to register your product with Audient ARC to receive update notifications and access to exclusive plugins and software. You can also do this later if necessary.

Windows Minimum System Requirements:

Windows 10 or Later

Intel Core 2 @ 1.6Ghz,

AMD equivalent, or ARM Processor

1GB RAM



iD App & Firmware Update

Launch the iD Software Mixer Application

Launch the iD48 Software Mixer application by finding it in the following folder:

Macintosh HD > Applications > iD Start > All Programs > Audient > iD

On macOS, the iD Software Mixer Application will launch into the Menu bar, in the top right corner of the screen. Click on the small iD icon to access the features of the application.

On Windows, the iD Software Mixer Application will launch into the system tray, typically in the bottom right corner of the screen. Right-click on the iD icon to access the features of the application.

For more information on the iD Software Mixer Application feature set, please refer to **page 30** onwards of this manual.

Check for Firmware Updates

If your computer is connected to the internet, the iD Software Mixer Application will check for firmware updates whenever a unit is connected. If there is a firmware update available then the iD Software Mixer Application will notify you again the next time you use the unit.

You can manually check for updates by going to the Help menu and selecting '**Check for Updates**'. It will notify you if you're on the latest version of firmware or if you need to update.

Registration With Audient ARC

When you first open the iD Software Mixer Application, a window will open asking you to register your unit to Audient ARC. Simply follow the instructions on-screen to create an account and register your unit.

This will give you access to free innovative software and services; meaning you'll have everything you need to get recording straight away.

Please note that second-hand purchases are not eligible for registration on Audient ARC, please read our ARC Terms and Conditions for more information: <https://audient.com/arc-terms-and-conditions/>

If you plan on registering the product at a later date, you can simply close the registration window. You'll see the window again the next time you use the unit.

Hardware Features

Microphone Preamplifiers & Line Inputs

iD48 features 8 Audient Console microphone preamplifiers. These preamps are based on the circuits found on Audient's classic consoles and are the same that are used across our entire 'iD Interface Range'.

The design features discrete Class-A circuitry providing exceedingly low distortion and noise performance. From a sonic point of view, iD48 is fast, open and detailed.

Amphenol™ XLR/TRS Jack combi-connectors provide microphone and line inputs. The line inputs are padded by -10dB before passing through the microphone preamplifiers to minimise clipping on line-level signals

The microphone preamplifiers feature:

- 58 dB of clean gain
- >2.8kΩ input impedance which provides a punchy tone from any microphone transducer type



Instrument Input

iD48 employs a discrete Class-A JFET instrument (D.I) input on channels one and two which is easily accessible on the front of the unit.

The JFET circuitry adds a tiny bit of colour and harmonics to the signal, making it sound great on guitars and basses.

Plugging in a TS (tip-sleeve unbalanced) jack will override the mic signal and turn either channel 1 or channel 2 into a fully-fledged, fantastic-sounding instrument input.

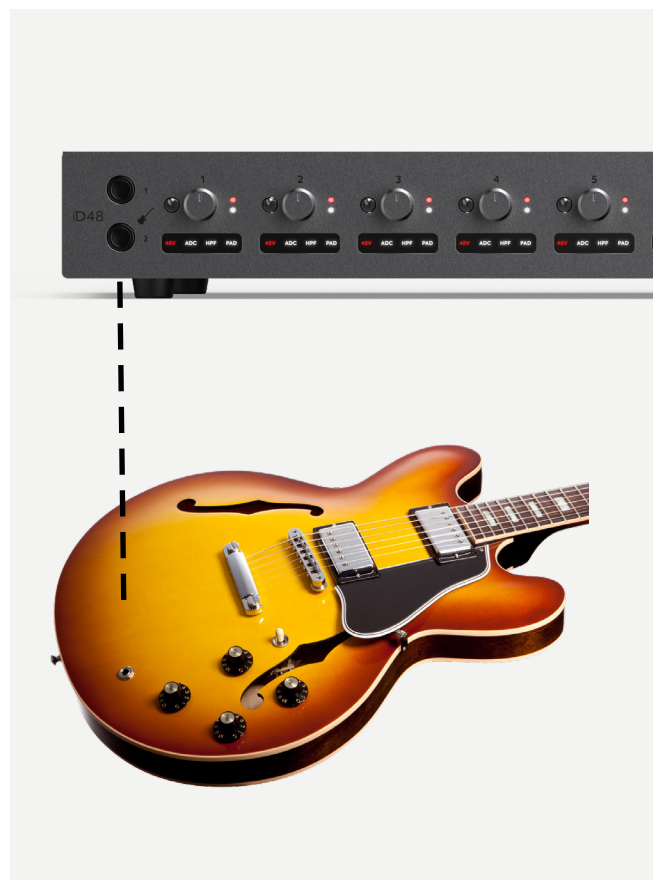



Input Controls

Below each channel's Gain Control, there is an indicator panel showing which of the channel's Input Controls are active. Each channel has the following input controls:

Phantom Power Switch - There is an independent phantom power switch for each microphone channel. When the switch is in the UP position, this provides full phantom power (48V \pm 4V, 10mA per channel) to the microphone connected to this channel.

Please note that the iD48 will only send phantom power to XLR connections, the TRS line inputs will not receive phantom power.

High Pass Filter - Each preamp also includes a switchable hardware high pass filter that has a cut-off frequency of 100Hz. This is good for removing rumble and room noise from your recordings. The high pass filter can be switched on and off from the included iD Software Mixer Application.

-10dB Pad - Each input features a switchable, hardware -10dB pad to help lower the signal level when recording particularly hot sources such as drums. The Pad can be switched on and off from the included iD Software Mixer Application.

ADC (Balanced Send & Returns) - Each channel has a switchable insert point before the ADC (Analog to Digital Converter) using the DB25 Inputs and Outputs on the rear of the interface.

There are three modes that the channel can be set to.

- Mic
- ADC Direct
- Mic Insert

The ADC light will illuminate when the unit is set to '**Mic Insert**' or '**ADC Direct**' mode to indicate that this input channel is taking the signal from the ADC Inputs on the rear of the unit instead of the Mic/Line Combi Connectors

These settings are referred to as the ADC Path Settings and are adjusted per channel in the included iD Software Mixer Application.

How to Utilise the Three ADC Path Settings

Mic

When using the **'Mic'** ADC Path setting, the ADC is fed directly from the output of the built in Audient Console Mic Preamps. The Line Output/Insert Send DB25 port can then be used as additional line outputs.

The additional line outputs can then be used to feed external hardware such as headphone amps.

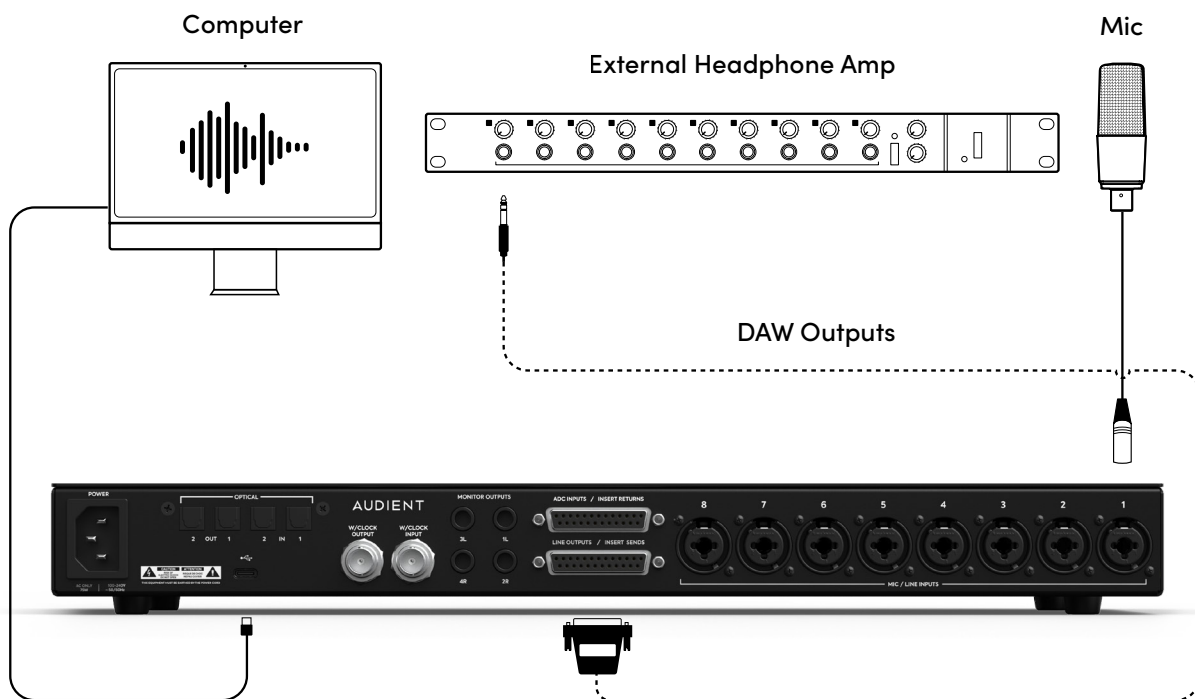

ADC Direct

When using the **'ADC Direct'** Setting, the ADC for this channel is fed from the Insert Return/ADC Input DB25 port, providing you a way to input audio whilst bypassing the iD48's built in Audient Console Mic Preamps for the cleanest signal path to the ADCs possible.

One use case of this would be if you wish to use an external analog preamp or wish to feed in a line level signal without passing it through iD48's preamps.

It is important to note that when in this mode, the signal from the Mic/Line input is not accessible.

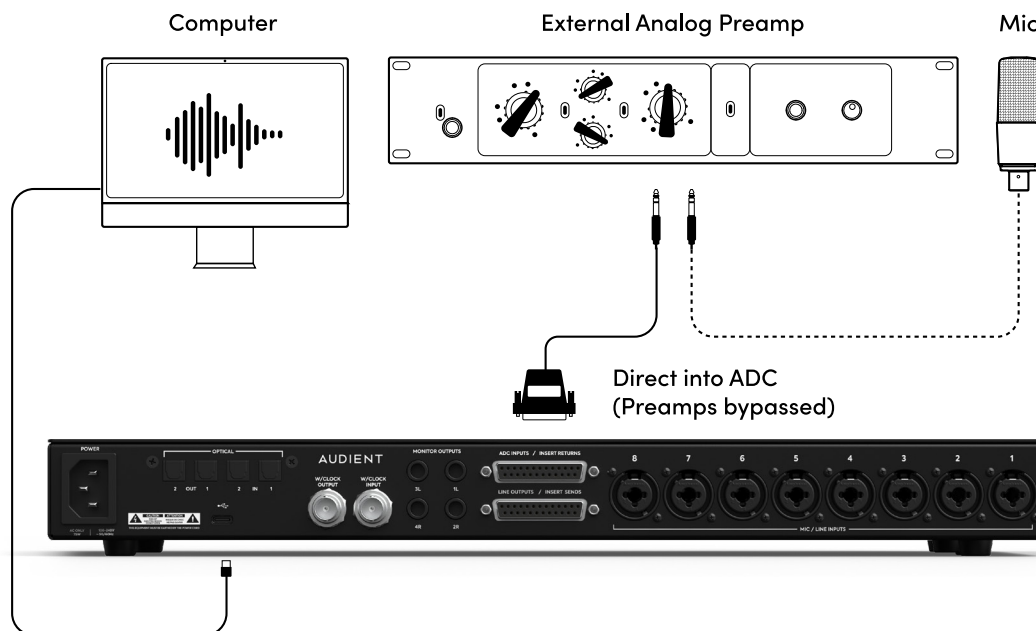

This setting can also be used if you wish to utilise hardware effects whilst Mixing in your DAW software.

The Line Output/Insert Send DB25 Port in this mode is fed from the DAC, rather than from the built in Audient Console Mic Preamp, and provides additional line outputs just like on the 'Mic' ADC Path setting.

You can therefore feed audio from your DAW to the Line Output/Insert Send DB25 Port, pass this through hardware effects and then return the processed audio to the Insert Return/ADC Input DB25 port to be re-recorded into your DAW software.

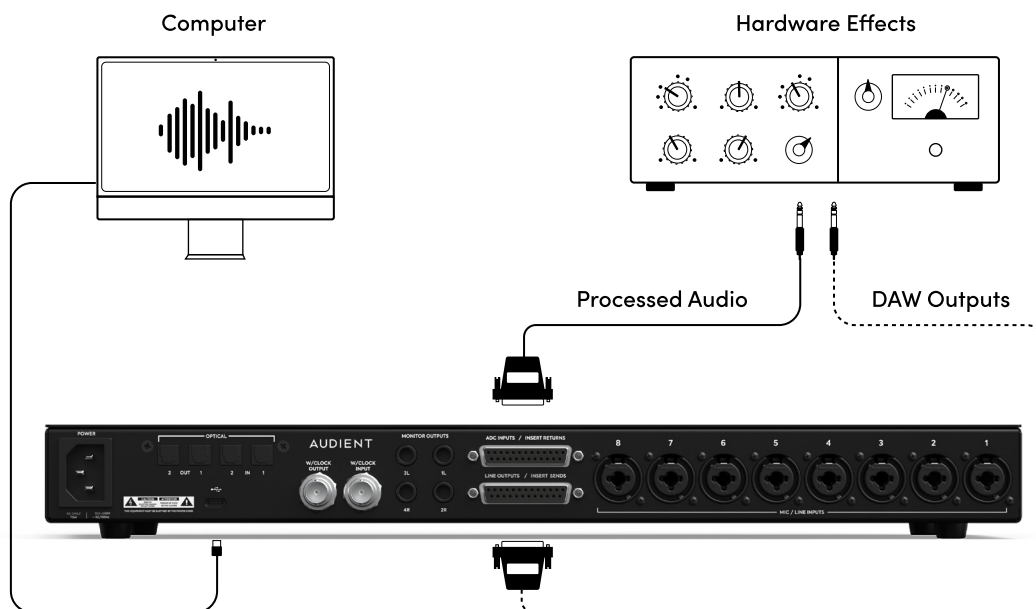

Most DAWs will have a ‘Hardware Insert’ mode or plug-in that allows you to easily route the audio in your DAW, please see your DAW software’s documentation or manual for information on how to use these features.

You will also need to set your Line Output routing in the software routing matrix to either **“DAW ANALOGUE”** or **“DAW DIGITAL”**, depending on which channels you wish to route the signal from. This is done in the System panel of the iD Mixer Software which is covered in more detail in the Software section of this Manual.

Mic Insert

When using the **'Mic Insert'** ADC Path Setting, the Line Outputs/Insert Sends and Insert Returns/ADC Input DB25 ports act as a Insert point.

This allows you to add hardware effects, such as a hardware compressor or EQ, between the output of the iD48's Preamp and the ADC input. This is perfect for building vocal chains or otherwise adding effects while tracking.

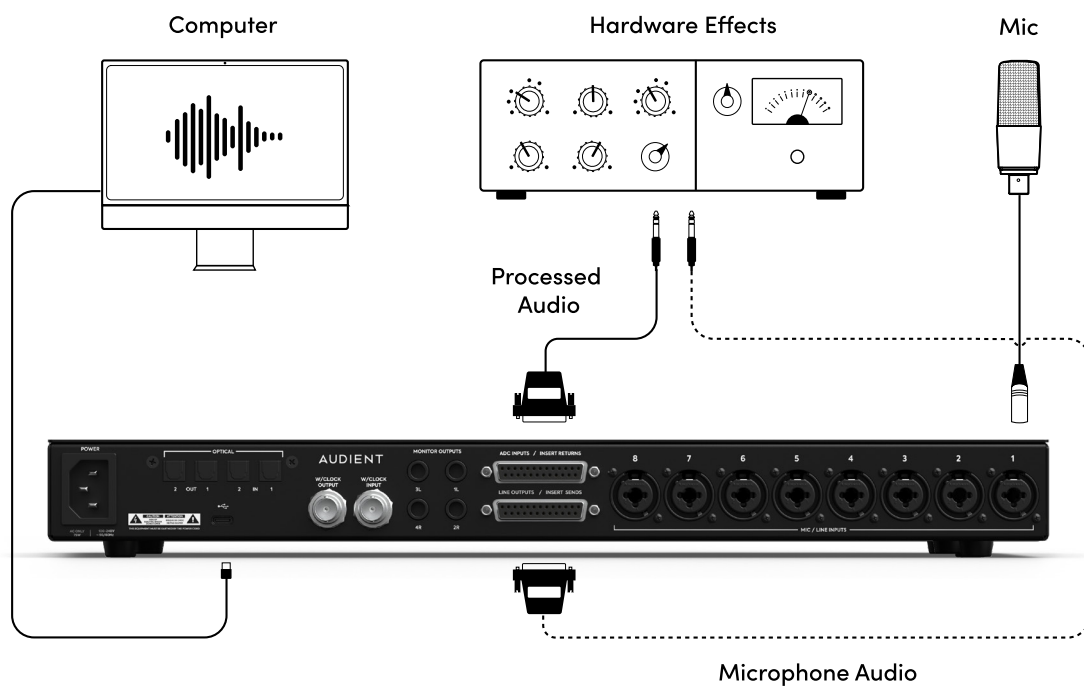

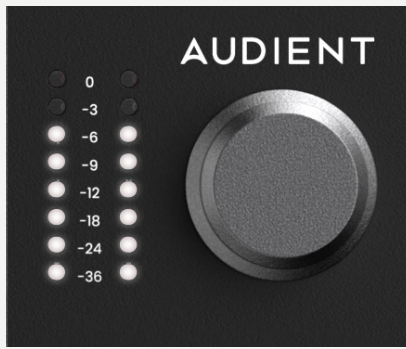

Monitor Control

The iD48 provides excellent monitor control functionality using the large aluminium Volume control.

Hardware Metering

The 8-segment hardware meters indicate the playback level of your Main Monitoring Mix in the iD Software Mixer Application.

Power Control

To power the iD48 Down, press and hold the Monitor Control for 3 seconds. A short LED animation will play and the unit will then be powered off.

To Power the unit on again, press the Monitor Control down once. A short LED animation will play and the unit will power up.

If the Unit is powered up but idle, i.e no audio is passing through the unit. The Meter LEDs will periodically show a short animation to indicate that the unit is still powered up.

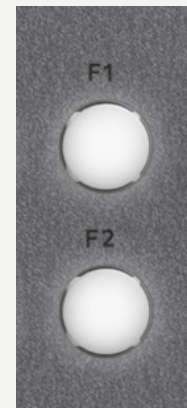

F-Keys

The two F buttons, F1 and F2 are the function keys and allow you to activate a number of monitoring functions from the iD Software Mixer Application. More information on how to set this up can be found in the Software section of this Manual.

The ALT Button

The ALT Button lets you quickly switch between your Main Monitors and a second set of alternative speakers. This is useful to check how your mix translates on various speaker sets.

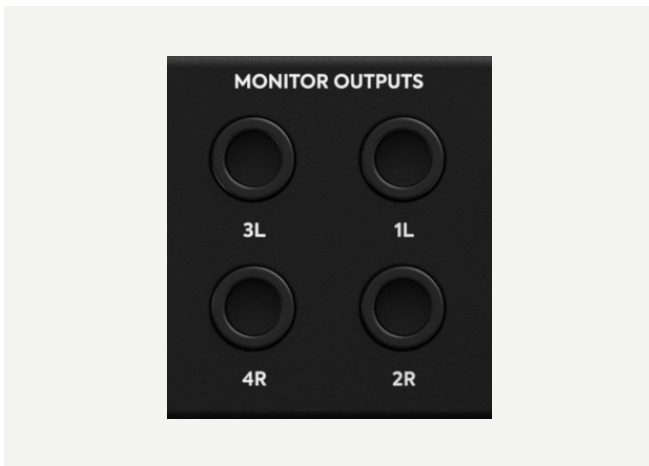

Monitor Outputs

iD48 has two pairs of dedicated stereo speaker outputs on the rear panel in the form of balanced TRS jack connectors. The outputs are impedance-balanced using the same topology as our flagship console, the ASP8024-HE.

The outputs are fed from high performance DACs (Digital to Analogue Convertors) sending clean audio to your speakers, perfect for critical listening.



Headphone Outputs

iD48 features two independent high-current headphone amplifiers. This can be accessed using both the 6.35mm sockets found on the front of the unit.

The headphone outputs can comfortably drive a wide range of headphone impedances meaning that you will get great-sounding audio no matter what model of headphones you have.

Each headphone Output has a dedicated volume control so you can accurately set the listening level.

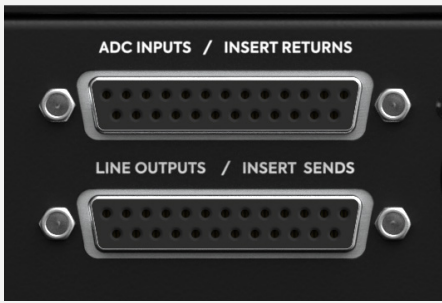

ADC Inputs/Insert Returns

This DB25 connector provides 8 balanced inputs in Tascam Format. These directly feed iD48's Analog to Digital Converters (ADCs) and can either be used as direct inputs to the ADCs or as insert returns depending on the ADC path settings selected for a particular channel. More information about the ADC Path Settings can be found on **page 15**.

Line Outputs/Insert Sends

This DB25 Connector provides 8 balanced outputs in Tascam Format. These are either fed from the Outputs of iD48's built in Audient Console Mic Preamps in order to be used as Insert Sends, or they can be used to send 8 line-level outputs. This is set by adjusting the ADC path setting for a particular channel.

Both the ADC Inputs/Insert Returns and Line Outputs/Insert Sends connections use a Tascam Format Pin Out. To ensure you use the correct looms for your iD48, please see the Tascam Format pinout diagram below.

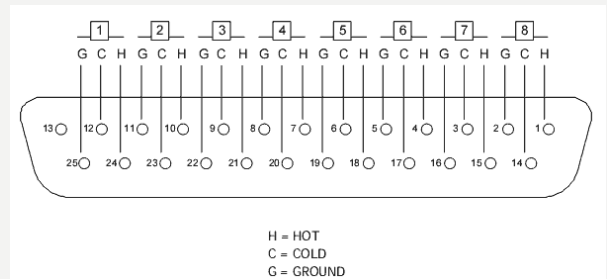

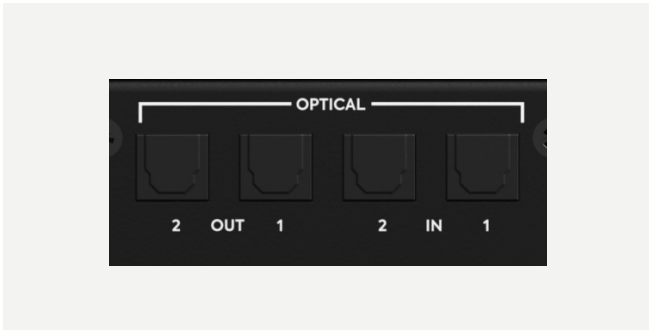

Digital Inputs and Outputs

iD48 features two optical inputs and two optical outputs. These can be set to operate Using S/PDIF or ADAT using the iD Software Mixer Application.

In S/PDIF mode, each optical connection can carry two channels of audio up to 96kHz.

Running in ADAT mode, each optical connection can carry 8 channels of audio at 44.1kHz and 48kHz and up to 4 channels of audio at 88.2kHz and 96kHz (due to how the ADAT SMUX protocol operates).

These digital connections are perfect for adding additional inputs and outputs to the iD48, such as adding additional Mic Preamps or providing additional monitoring outputs. This is very useful for larger recording sessions.

More information on how the iD Software Mixer Application is used to route to the optical outputs can be found under The Routing Matrix section of this manual.



Word Clock Input and Output

iD48 provides both a BNC word clock input and a BNC word clock output to allow the interface to be synced to external clocks and digital devices. The Word Clock input has a switchable 75 Ohm termination which can be adjusted in the iD Software Mixer Application. This should be enabled if the iD48 is the last or only device in a BNC word clock chain. This stops any clock reflections and provides more stable clocking.

Clocking Information

When connecting external digital devices to iD48, it is important to get the clocking setup correct to ensure all the devices are synced. If this is not set correctly, you may experience clicks, pops or distortion in your audio.

It is important to note that in a digital setup, there should only ever be one device acting as the master clock. All other devices will then sync to this, either via the Optical ports or the BNC Word Clock connections.

With a wealth of digital I/O, there are many ways that the iD48 can be set up to clock with other digital equipment.

iD48 Syncing to an External Device via ADAT or S/PDIF

In this setup, the external device would be acting as the master clock. The external device's Optical Output is connected to iD48's Optical 1 Input.

The iD48's Clock Source is set to **'Digital 1'** or **'Digital 2'**, depending on which optical port you are using. This allows the iD48 to sync to the incoming ADAT stream from the external device.

Mic Preamp

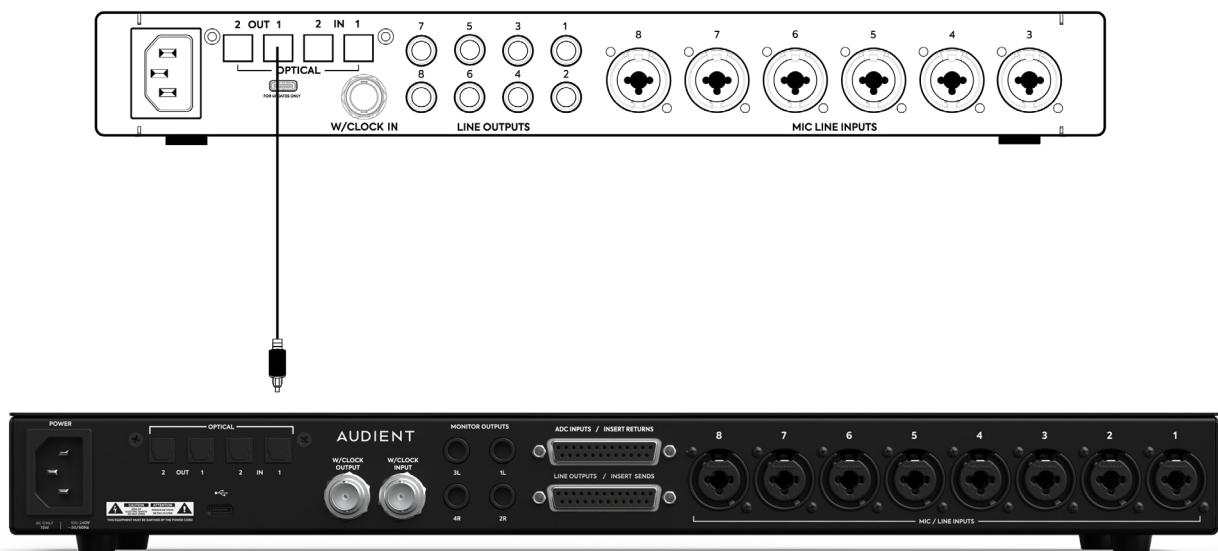

iD48 Master clock via ADAT or S/PDIF

In this setup, the iD48 would be acting as the master clock and sending the clock to an external device via the Optical ports.

The External Device's Optical output is connected to iD48's Optical Input 1 and iD48's Optical Output 1 is connected to the external device's Optical Input.

The iD48's Clock source is set to Internal as it is acting as the master clock. The external device is set up to sync to the incoming clock via its Optical port.

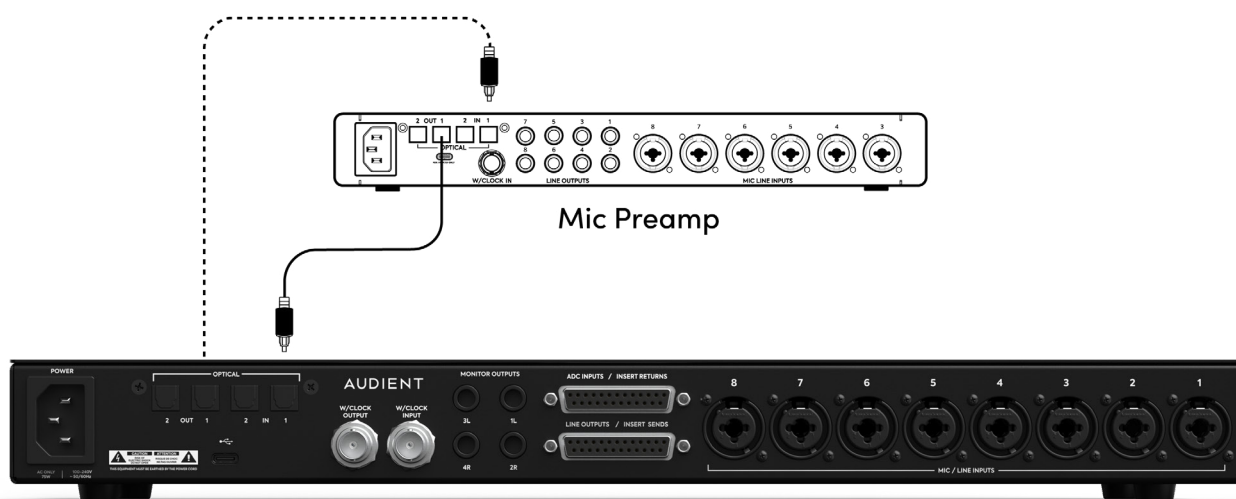

iD48 Master Clock via BNC

In this setup, the iD48 would act as the master clock and send the clock to two external devices via its BNC Word Clock Output. The first external device's Optical Output is connected to iD48's Optical Input 1 and iD48's Optical Output 1 is connected to the external device's optical input.

Similarly, the second external device's Optical Output is connected to iD48's Optical Input 2 and iD48's Optical Output 2 is connected to the external device's optical input.

Now, a BNC T-Connector is plugged into the BNC word clock input of the first device. This is used to daisy chain the BNC word clock signal from the first external device to the second. A 75-ohm BNC Word Clock cable is then connected from iD48's BNC Word Clock output to the Input of the BNC T-Connector. A second 75-ohm BNC Word Clock cable is then connected from the output of the BNC T-Connector to the BNC Word Clock input of the second External Device.

The iD48's Clock source is set to Internal as it is acting as the master clock. The external devices should both be set up to sync to the incoming clock via their BNC Word Clock inputs. To ensure correct operation, 75-Ohm Termination should be enabled on only the second external device.

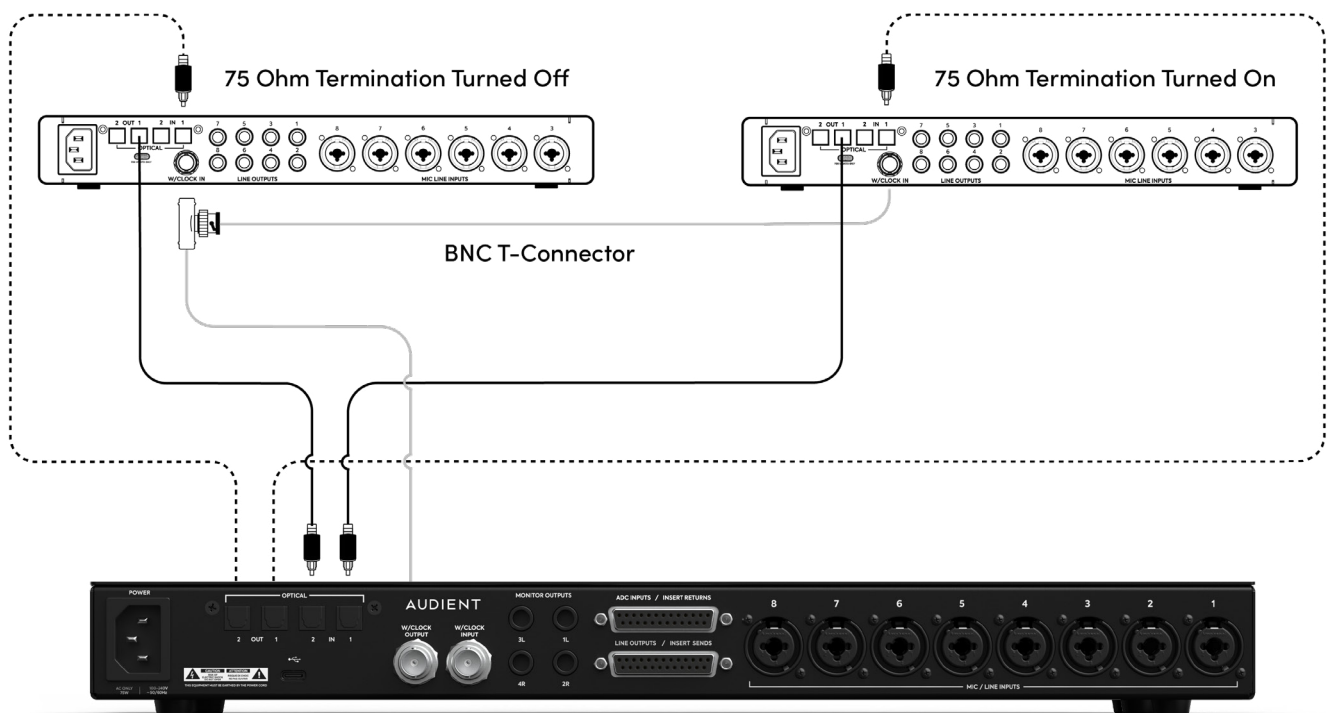

iD48 Syncing via Master Clock

In this setup, an external clock source is being used to provide a clock to the iD48 via its BNC Word Clock input.

A 75-Ohm BNC Word Clock Cable is connected to the BNC output of the external Clock and is plugged into iD48's Word Clock input.

iD48's Clock Source should now be set to Word Clock. In addition, the 75 Ohm termination should be enabled if the iD48 is the last, or only device in the Word Clock chain.



The above setups cover the most common configurations but are not exhaustive. For more information regarding clocking, please visit our Support Help Desk or contact us at support@audient.com

iD48 Rack Ear Fitting Instructions

If you wish to add iD48 to a Rack, then this can be achieved by fitting the Rack Ears included in the box. With the Rack Ears fitted, the iD48 is a standard 1RU unit.

First, you would need to remove the rubber feet from the underside of the unit. To do this remove the Phillips head screws from the centre of each foot with a screwdriver, and lift the foot off the chassis.

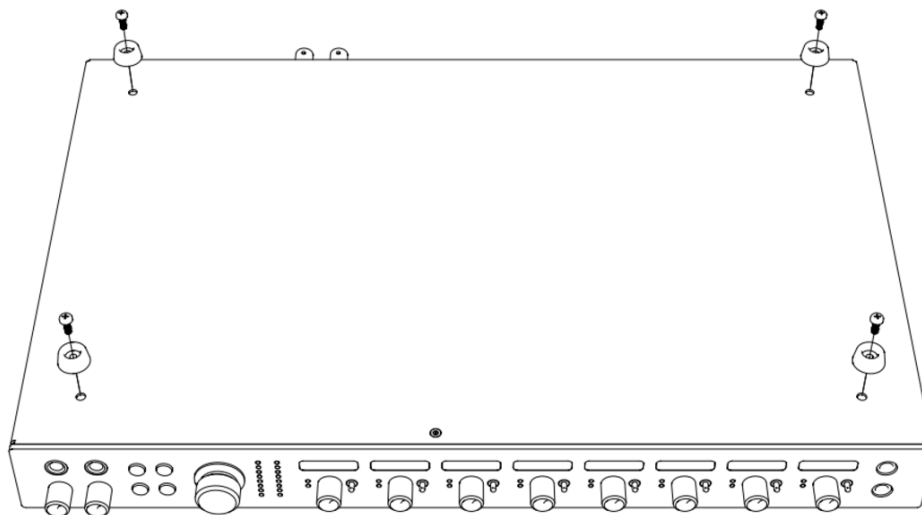

Now, the Rack Ears can be attached to the side of the unit. On each side of the unit, there are four threaded holes. Align the Rack Ears with these holes, and using a screwdriver, screw the 4 included M3 Pozi screws into the threaded holes to secure the Rack Ear as shown below.

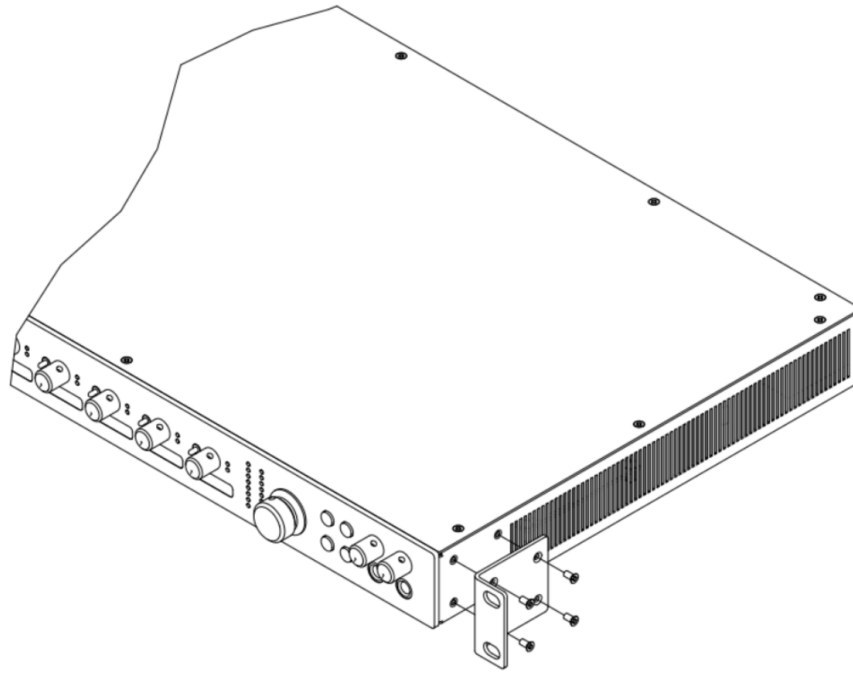

Repeat this process for the other Rack Ear. With the Rack Ears fitted, the iD48 can now be added to your Rack.

Rack Safety Instructions

iD48 requires 1U of vertical rack space and a minimum of 400mm rack depth, allowing for cables. It weighs 3.9kg and for fixed installations - such as a studio - the four front panel mounting screws will provide adequate support. The front panel depth is 3mm at the mounting positions.

iD48 does not generate significant heat and is cooled by natural convection. We recommend that the unit should not be used in locations where the ambient temperature is greater than 35°C. Ventilation is via slots on either side of the enclosure, and these must be clear of obstruction.

Do not mount iD48 immediately above or below any other equipment which generates significant heat, for example, a power amplifier.

Software Features

iD Software Mixer Application

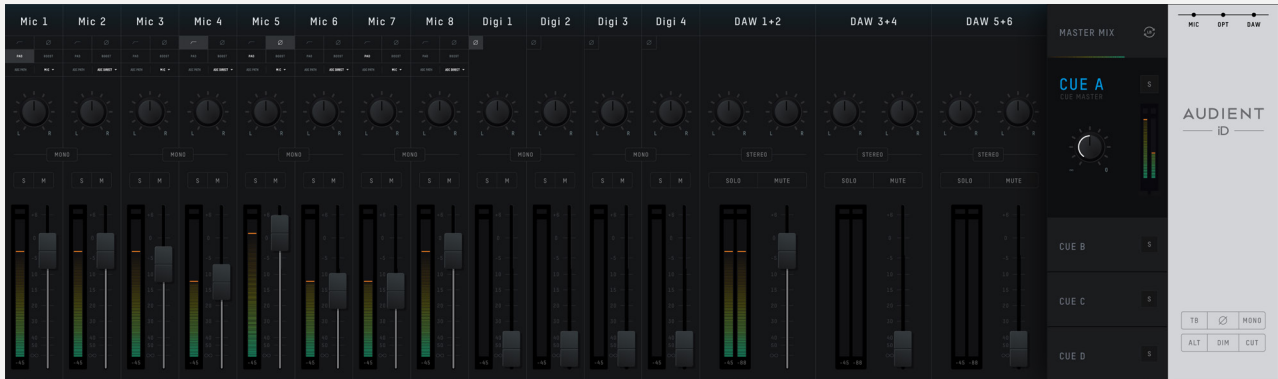

Input Channels - Channel Types

The iD Software Mixer Application features three types of input channels:

Mic Inputs

These are the inputs where you will see the signal from the iD48's eight analogue inputs.

Digital Inputs

These are the inputs from the iD48's optical inputs. The number of digital inputs present on the iD Software Mixer Application depends on the digital input type (S/PDIF or ADAT) and the sample rate being used.

DAW Returns

These are the signals being played back from your DAW. The iD48 has 10 DAW Return Channels, allowing you to set up multiple cue mixes or sends to hardware outboard gear.

Using these three channel types you can build up your main monitor mix and up to four additional cue mixes.

It's important to note that the iD Software Mixer Application only controls the monitoring of the iD48. Changes made to the iD Software Mixer won't affect the level present in your DAW or audio software.

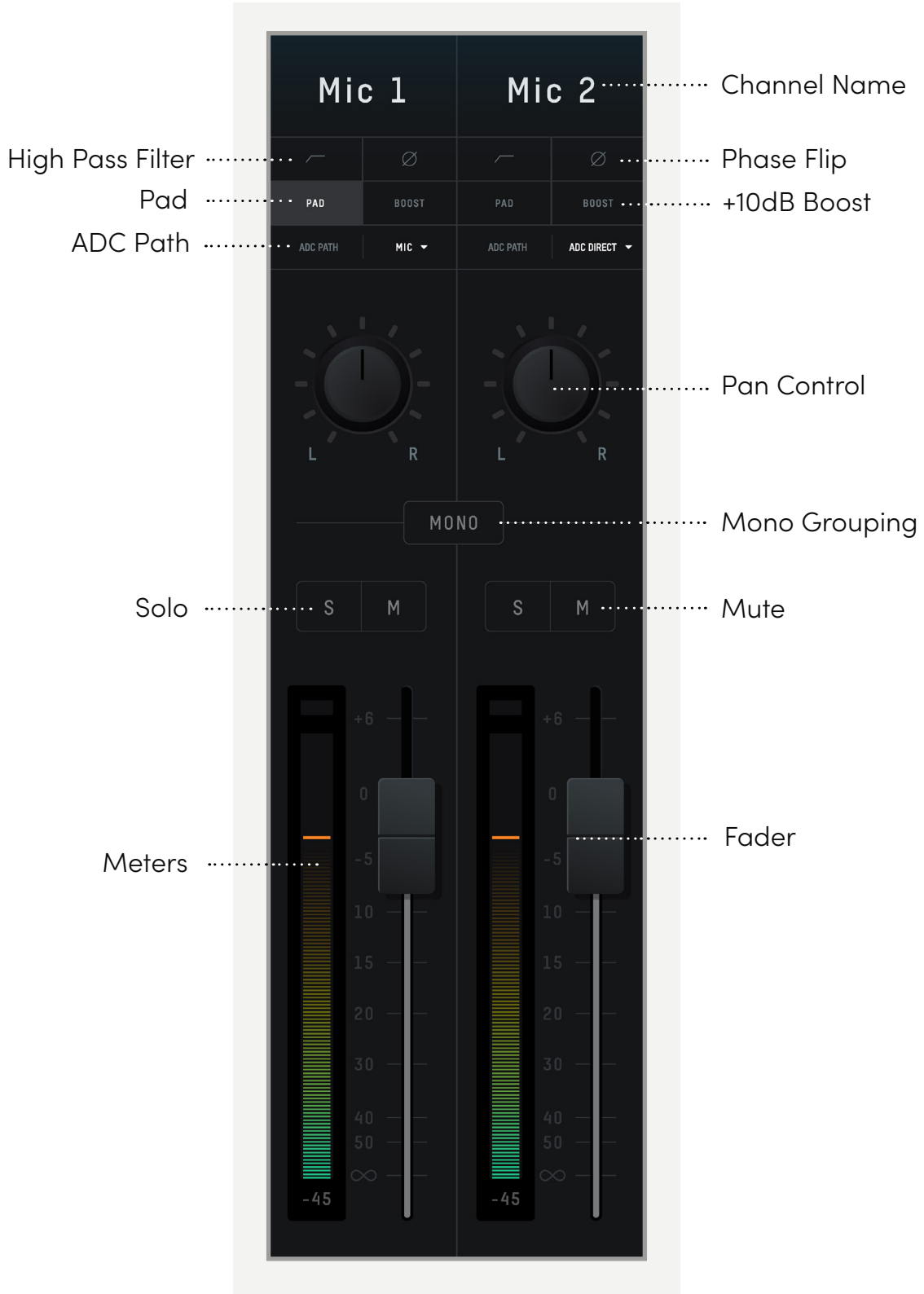

Channel Features

Channel Name

By double-clicking on the name of the channel you can rename it to help you organise your iD Software Mixer. You could name a channel 'Kick' or 'Snare' for example.

Input Controls

High Pass Filter - This activates the analogue high pass filter on the input of this channel. The cut-off frequency of the High Pass Filter is 100Hz so is great for removing rumble and room noise from your recordings.

Phase Flip - Inverts the polarity of the signal by 180° to stop phase cancellation. This is useful if you are micing the rear of a guitar amplifier or the underside of a snare drum.

Pad - The Pad control reduces the incoming signal level by -10dB using an analog pad circuit. This is helpful if recording a very high signal level and need to reduce the signal level to stop clipping from occurring.

Boost - Selecting this will digitally boost the incoming signal by +10dB for recording quiet sources. This will also affect the audio being fed into your DAW.

ADC Path - This drop-down menu allows you to select between the following ADC Path Settings: Mic, ADC Direct, Mic Insert.

More information on how these ADC Path Settings can be used can be found in the Hardware section of this manual.

Pan Control

Allows you to send the audio to the left, to the right or anywhere between on your Main Monitor Mix or Cue Mixes.

Stereo Grouping

Allows you to group two adjacent channels together into a stereo channel with a single fader controlling the level of both channels. When a channel is stereo grouped, the pans will automatically be set to hard left and hard right.

Solo

The Solo button mutes all other channels other than the one that is currently soloed. Multiple channels can be soloed at one time.

Mute

The Mute button stops this channel from outputting audio whilst it is engaged.

Fader

The fader controls the amount of signal that is sent to the currently selected mix. This can be set to anywhere between -inf dB to +6dB.

Meter

The meter shows the current signal level in dBFS. Should the signal level exceed 0dBFS then the peak indicators will illuminate red to indicate a peak. The peak indicators can be turned off by clicking on them. You can also turn off all peak indicators using Alt + Click.

Master Section Features

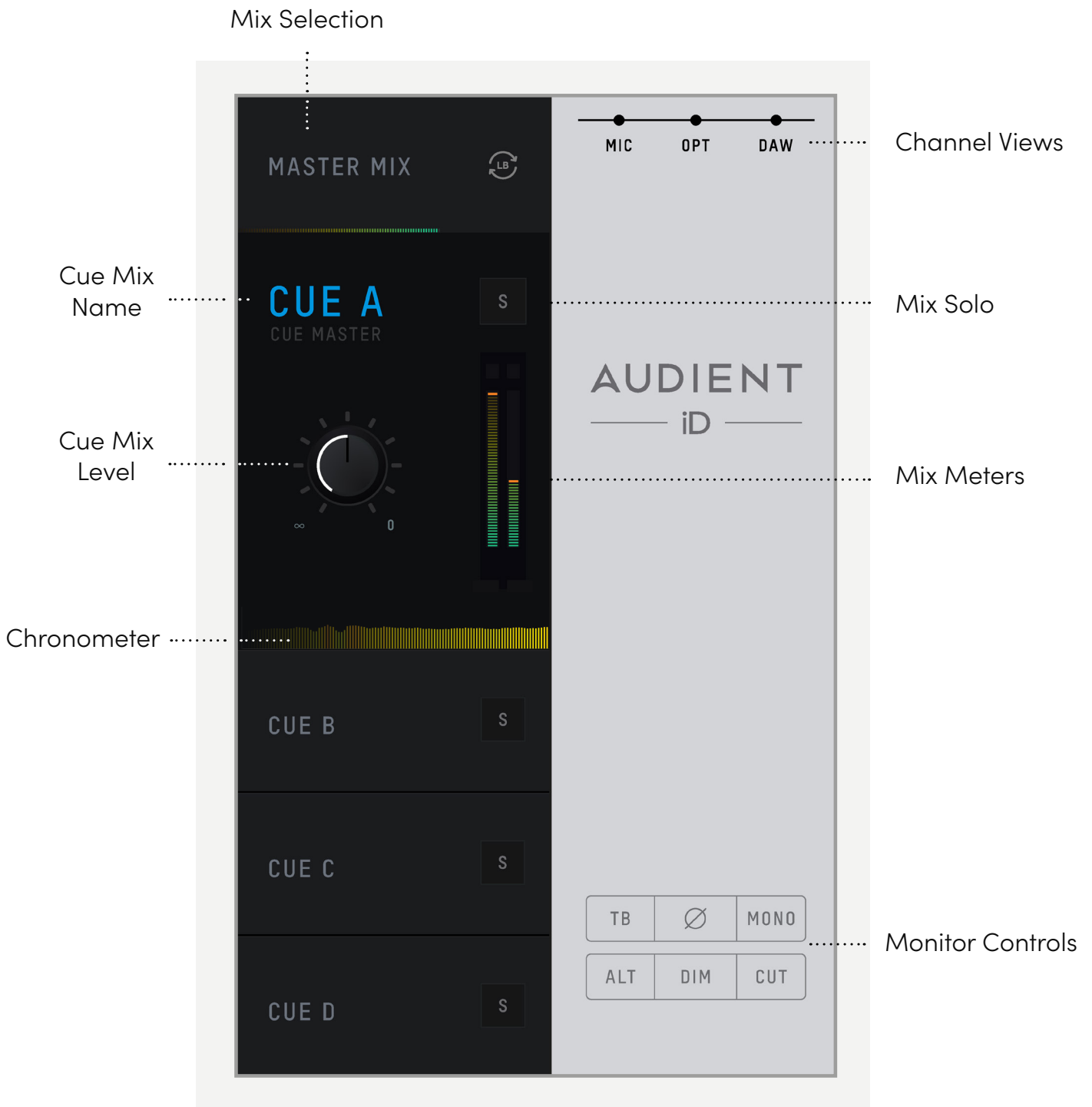

Channel Features

Mix Selection

Clicking on one of the mix tabs allows you to make changes to that mix. When a mix is selected, it expands to reveal additional controls for that mix.

Cue Mix Name

Double-clicking on a Cue Mixes name allows you to rename the Cue Mix. If, for example, you were creating mixes for two separate band members, you could name them 'Drummer' and 'Guitarist'.

Mix Solo

The Solo button allows you to audition each of the Cue Mixes through your monitors.

Mix Level

The Mix level allows you to control the overall level of the Cue Mix that is sent to the outputs.

Mix Meters

The Mix meters show the master signal level of the selected mix.

Chronometer

The Chronometer allows you to see not only the current signal level but also the signal level from a few seconds previously.

This can be great to track down a sudden loud transient on a particular cue mix or to monitor the change in level over time as you make changes to a mix.

Channel Views

These three buttons allow you to control which of the three channel types are shown in the mixer. If for example, you weren't using the digital inputs for a particular project, you can simply hide the optical channels by clicking 'OPT'.

Monitor Controls

These six buttons control various aspects of iD48's monitor controller capability. The function of each control can be found below:

- **TB (Talkback)**

The Talkback button switches talkback on and off. More information regarding talkback and its various settings can be found in the 'System Panel' section of this manual.

- **∅ (Phase Flip)**

Pressing this switch flips the phase of one side of the stereo field. Pressing this switch will also trigger the Mono button. This will remove centred elements from your monitoring in order to hear the panned elements of a mix.

- **Mono**

The Mono button sums the stereo outputs down to mono. This can be used to quickly check the mono compatibility of your mix to make sure it'll sound great almost anywhere.

- **ALT**

Alt allows you to quickly switch your monitor path to a secondary set of monitors to let you check how your mix translates on various speakers.

You can select which outputs the 'ALT' monitor control flips to in the System Panel.

- **DIM**

Reduces the output level by a preset amount which can be great if you get a call or need to quickly chat to someone during a session.

- **Cut**

Cuts all signal currently being sent to the Main Mix of the iD48.

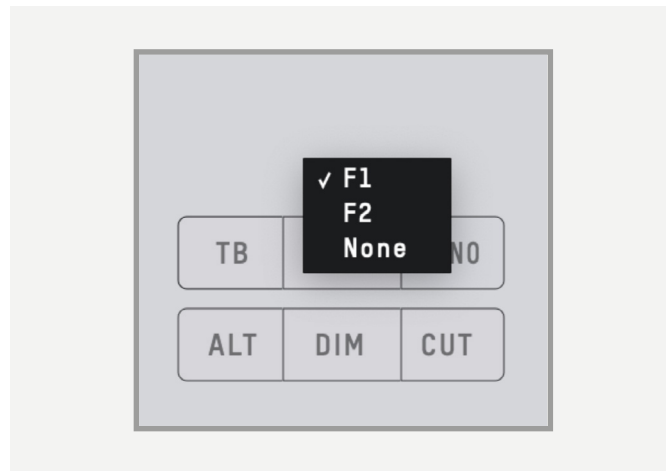

Assigning F-Keys

Various functions of the iD Software Mixer Application can be assigned to the Function Keys of the iD48 to allow you to quickly control your monitoring at the click of a button.

To assign a monitor control to an F-Key, simply right click on the control and select the F-Key.

System Panel Features

Digital Input and Output Format

Default Clock Source

Word Clock Termination

Mono Mode

DIM and ALT Trim Settings

Output Routing Selection

Routing Matrix

The screenshot shows the 'SYSTEM PANEL' interface with a 'ROUTING' section. On the left, there are control sections for 'DIGITAL INPUTS', 'DIGITAL OUTPUTS', 'DEFAULT CLOCK SOURCE', 'WORD CLOCK TERMINATE', 'MONO MODE', and 'TRIM SETTINGS'. The main routing area includes columns for 'MONITOR OUTPUTS', 'LINE OUTPUTS', 'DIGITAL OUTPUTS 1-8', 'DIGITAL OUTPUTS 9-16', and 'FALCKBACK'. The routing matrix has rows for 'STEREO 1+2', 'STEREO 3+4', '5+6', and '7+8'. Each cell in the matrix contains a gain knob and a routing selection button. The 'TRIM SETTINGS' section has two knobs labeled 'DIM' and 'ALT' with scales from -∞ to +6.

MONITOR OUTPUTS	LINE OUTPUTS	DIGITAL OUTPUTS 1-8	DIGITAL OUTPUTS 9-16	FALCKBACK			
	MAIN MIX	ALT SPK	CUE A	CUE B	CUE C	CUE D	DAW THRU
STEREO 1 + 2	[Knob]	[Knob]	[Knob]	[Knob]	[Knob]	[Knob]	[Knob]
STEREO 3 + 4	[Knob]	[Knob]	[Knob]	[Knob]	[Knob]	[Knob]	[Knob]
5 + 6	[Knob]	[Knob]	[Knob]	[Knob]	[Knob]	[Knob]	[Knob]
7 + 8	[Knob]	[Knob]	[Knob]	[Knob]	[Knob]	[Knob]	[Knob]

System Panel Features

Digital Input/Output Format

This option allows you to select whether the Optical Inputs and Outputs uses the ADAT or the S/PDIF digital format. When using S/PDIF each optical port can handle 2 channels of audio. When using ADAT, each optical port can handle 8 channels of audio at 44.1kHz or 48kHz, or 4 channels of audio at 88.2kHz or 96kHz.

If required, one Input/Output can be set to ADAT and the other to S/PDIF at the same time.

Preferred Clock Source

The clock source can be selected from either the internal clock, one of the two optical inputs or the Word clock input. More information about choosing a clock source can be found in the clocking section of this manual.

When using an external clock source the indicator beside the selector shows the current status of the clock on that input.

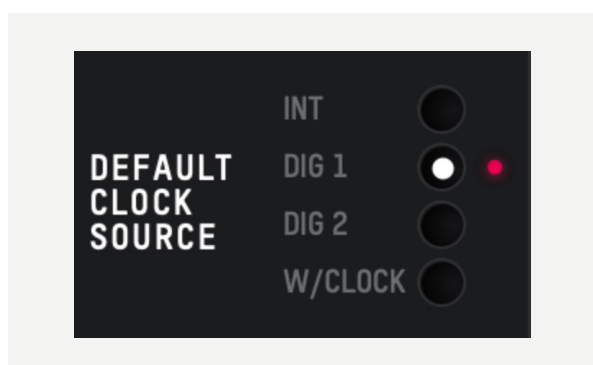

- **Red** - No clock signal detected on input.
- **Amber** - A clock signal is detected but at a different sample rate to iD48.
- **Green** - A clock signal is detected and is at the correct sample rate.

To ensure you are getting a reliable sync with an external clock source, the indicator should be green.

If a red indicator is shown, please check the physical connection of the clock source and ensure that the correct digital format is selected. If an orange indicator is shown, adjust the sample rate of either the external device or iD48 so that the sample rates match.

Word Clock Termination

This control lets you enable or disable the 75-Ohm Termination on iD48's BNC Word Clock Input. More information about Word Clock termination, and when you may require this can be found in the clocking section of this manual.

Mono Mode

When iD48's Mono feature is engaged this option controls whether the mono signal is sent to the left, right or both monitors.

Dim Trim Level

When iD48's dim function is engaged, this control defines how much the level is reduced by.

ALT Speaker Trim Level

This control defines the level drop/boost when iD48 is switched to ALT speaker mode. This is used to balance levels between different speaker brands.

Output Routing Selection

Opens the Routing Matrix for either the Monitor Outputs, Line Outputs, Digital Outputs or the Talkback channel.

Routing Matrix

The Routing Matrix allows you to control the audio source for each of iD48's outputs from the following options:

- **Main Mix** - This takes the signal from the Master Mix of the iD Software Mixer. This is what is usually used for most standard playback.
- **ALT** - This takes signal from the Master Mix but only when the Alt speaker mode is active.

- **Cue A, B, C & D** - This takes signal from the Cue Mixes which can be created using the iD Software Mixer. Please note that the hardware volume control does not affect these mixes and the Cue's have separate trims which can be adjusted when the Cue Mix is selected in the Main Mixer Window.
- **DAW THRU** - This allows you to route to outputs exactly as they would appear in your DAW. For example, if you set Analogue out 1+2 to DAW THRU, anything your DAW sends out to Outputs 1+2 will be sent directly to Analogue Outputs 1+2.

Please note that in DAW THRU, the channel in question will bypass any volume control and audio will be passed at full scale. If this output is sent to a set of monitors without inline attenuation, this may be very loud. The only exception to this is the headphone outputs where the volume control will still function even in DAW THRU mode.

Line Outputs Routing Matrix

Beyond the typical Main Mix, ALT speaker and CUE mix options, the Line Output's Routing Matrix includes two additional options instead of DAW THRU to provide further flexibility; **DAW Analogue** and **DAW ADAT**.

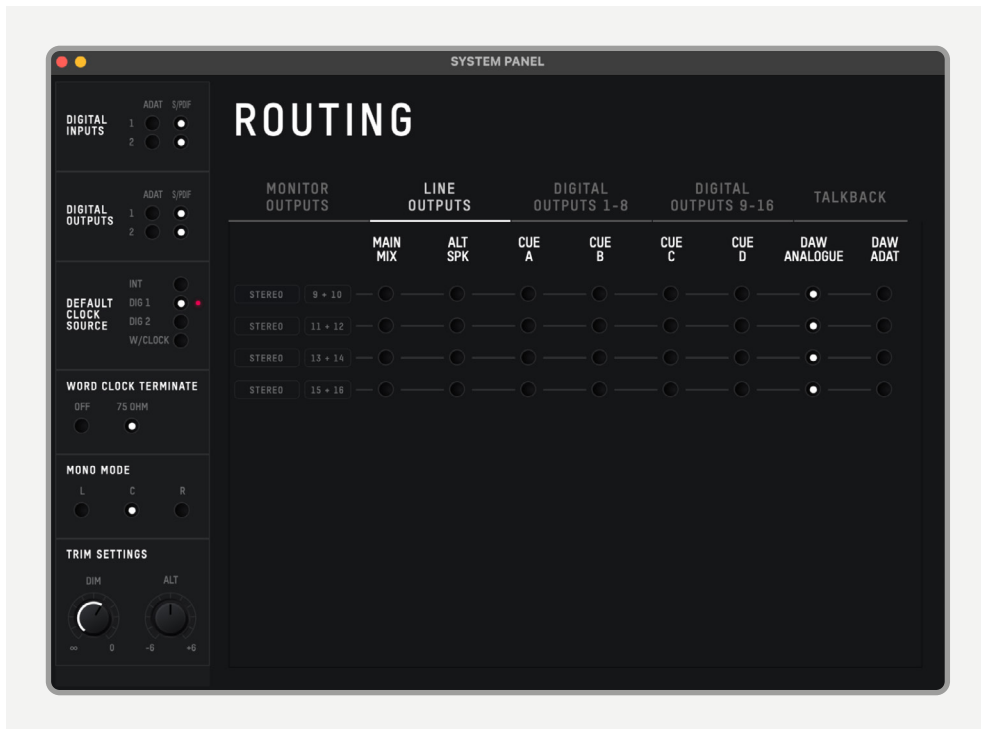

DAW Analogue

When set to DAW Analogue, Line Outputs 1 to 8 are fed from output channels 1-8 respectively.

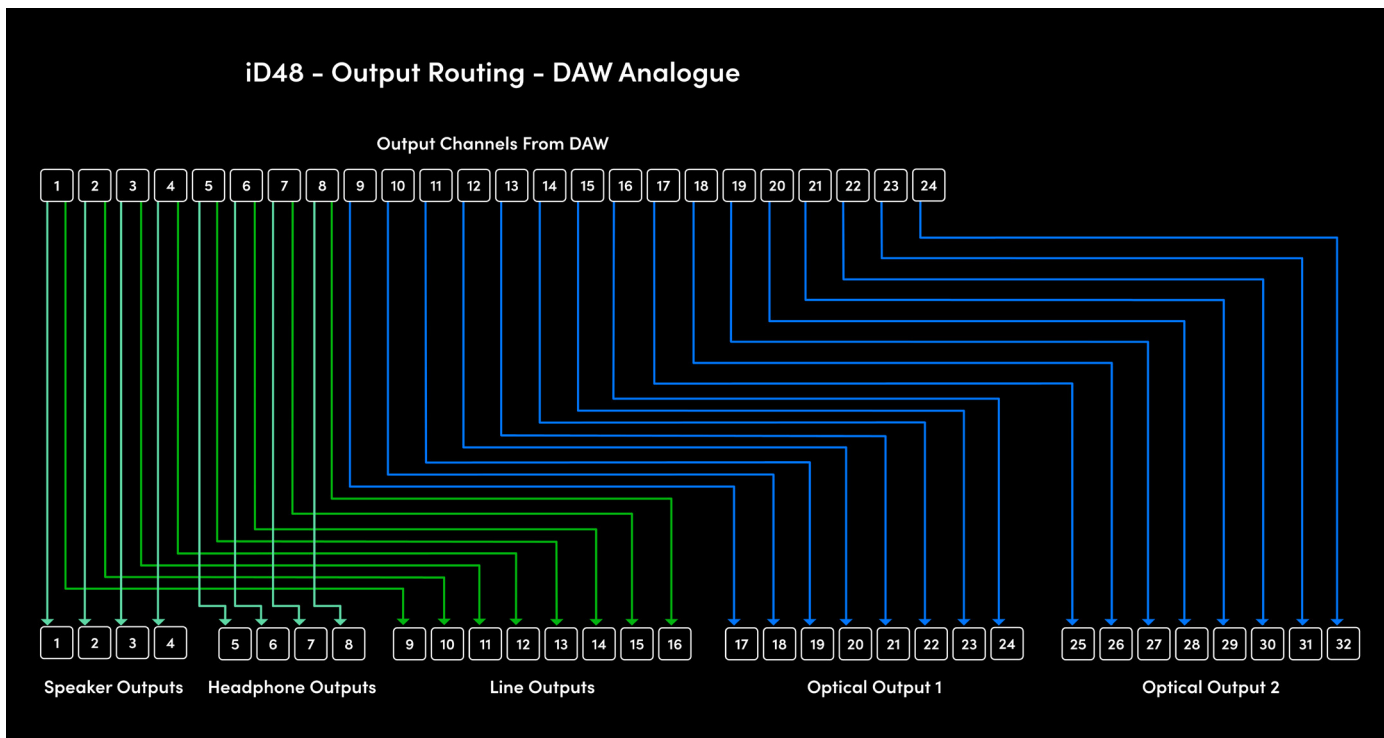

DAW ADAT

When set to DAW ADAT, Line Outputs 1-8 are fed from output channels 9-16 respectively.

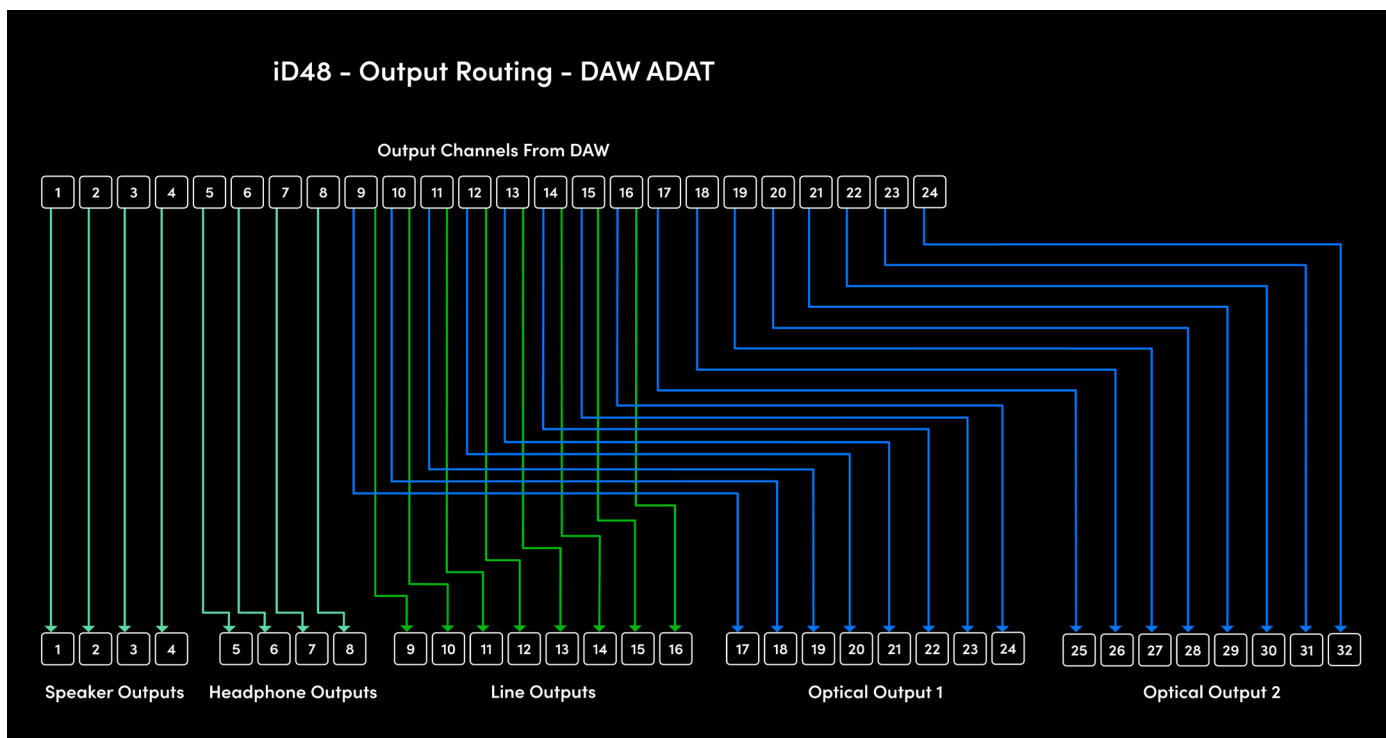

Please note that it's possible to assign each Line Output channel differently. For example, you could have Line Outputs 1+2 set to DAW Analogue and being fed from output channels 1+2, and at the same time, Line Outputs 3+4 are set to DAW Digital and are being fed from output channels 11+12.

Along with each input channel also having an independent Mic Mode setting, this provides a huge amount of routing flexibility when incorporating external hardware equipment into your setup.

For example, the flexible routing makes the iD48's Line Outputs perfect for adding hardware effects, such as compressors, or reverbs as inserts in your DAW. The process of setting up hardware inserts will differ between DAWs and therefore, it is outside of the scope of this manual to explain this process. We'd recommend consulting the documentation for your DAW to find further information.

Output Routing Signal Flow Diagram

The Diagram below shows how the iD48's output channels in the DAW are routed to the Physical outputs via the Software Mixer and the Routing Matrix

The Routing Matrix allows you to choose which source is routed to a particular output, either one of the Mixes from the Software Mixer, or via a direct send using the DAW THRU, DAW Analogue and DAW Digital functions

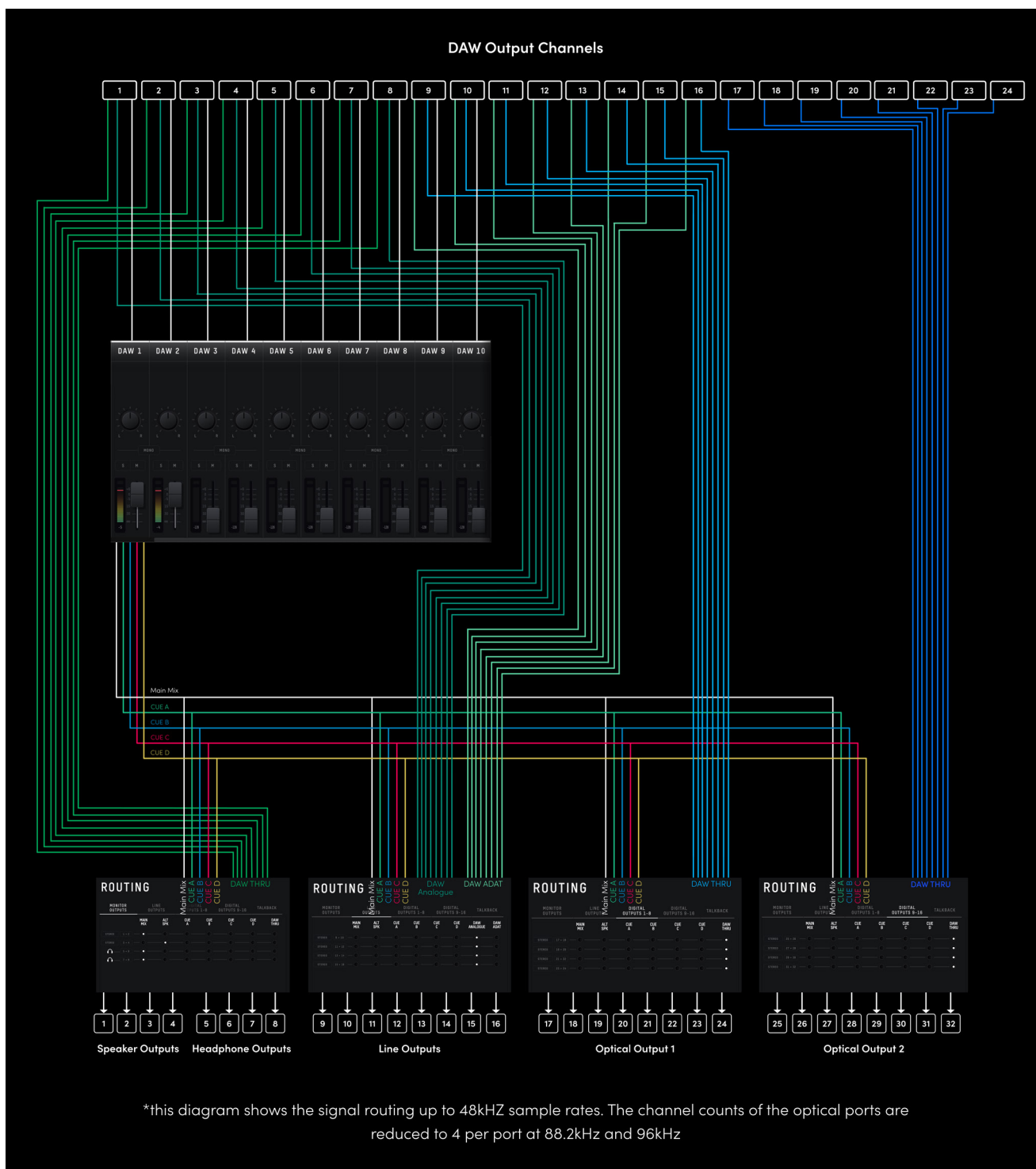

Talkback

iD48's Talkback function allows you to take the signal from a microphone and send it to the Cue Mixes. This means that you can communicate directly with performers and artists while tracking to give feedback and instruction. You can adjust Talkback settings from the Talkback tab of the System Panel.

Talkback Source

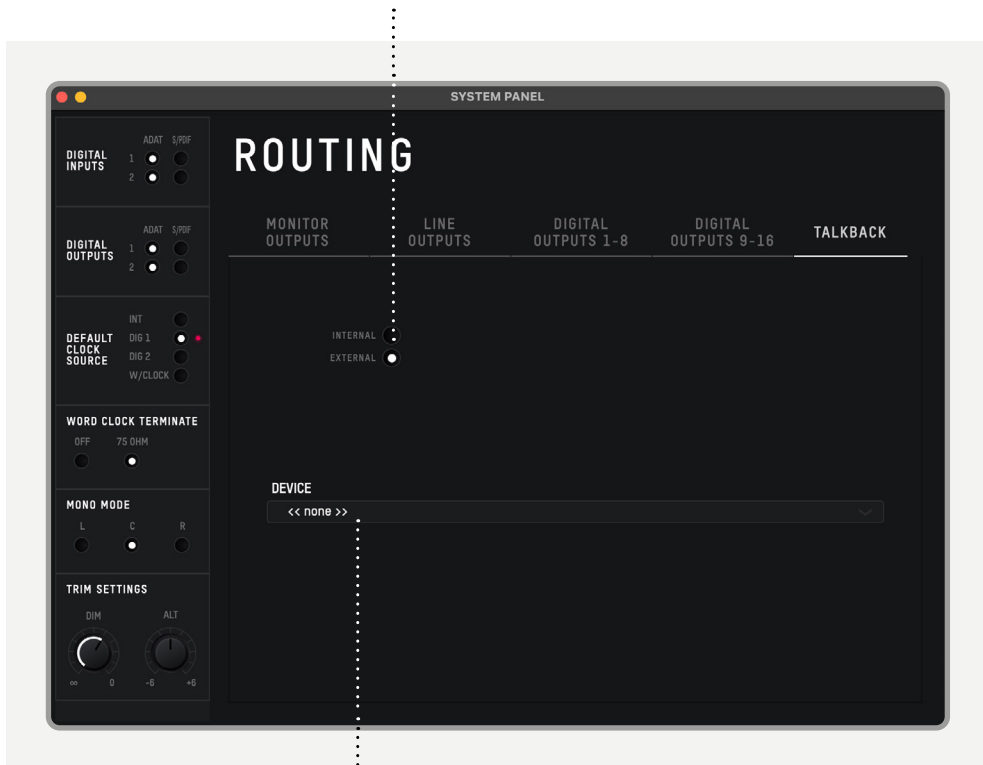

Talkback Device

Talkback

The Talkback source allows the talkback input to be taken from one of iD48's internal inputs or from an external device connected to the host computer (such as a built-in microphone or USB microphone).

When you select an internal input as your Talkback channel, the corresponding channel in the iD Software Mixer will be changed to a Talkback channel which will have a TB button in the centre.

If External Device is selected then you'll see a drop-down menu to choose which external device you wish to use. When using an external device, the talkback signal will appear on channel DAW 10.

Talkback can be turned on or off by pressing the TB button on that channel, the TB button in the master section or using one of the F-keys if assigned to the TB function.

The Talkback is only sent to the CUE mixes as you would not want your talkback to also playback through the Main Speakers. Therefore, faders will only appear for the Talkback channels on the Cue mixes, not on the Main Mix.

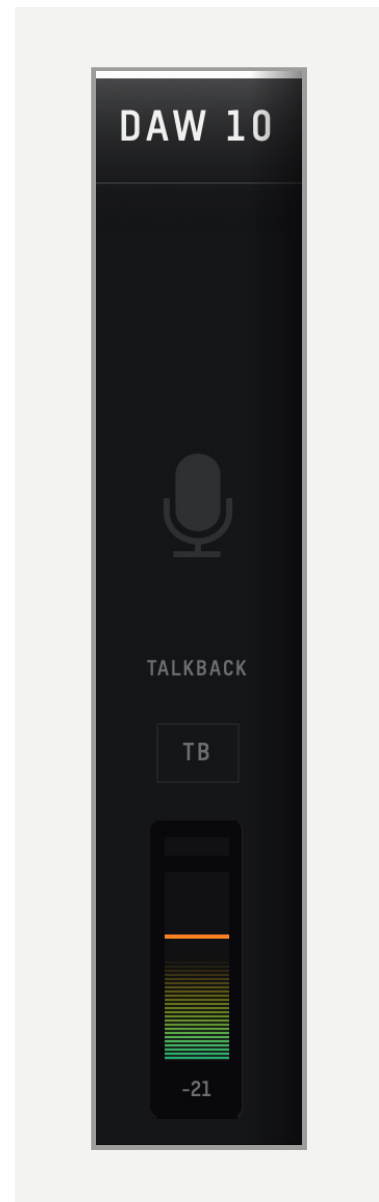

Saving & Loading Mixer Presets

To allow you to quickly setup your iD Software Mixer during a session you can save and load various presets. This is great if you are moving between different recording scenarios quite often.

Mixer presets can be saved and loaded in two ways:

- Using the File menu and selecting either Save or Open.
- Using standard keyboard shortcuts :

Save: Mac - **Cmd + S**

Windows - **Ctrl + S**

Load: Mac - **Cmd + O**

Windows - **Ctrl + O**

Saving a Preset

To save a preset, simply setup your mixer the way that you'd like. Then select **File > Save** as explained above. The iD Software Mixer window should then show the **'Save mixer Configuration'** dialog.



Simply enter the name of your preset and press the **'Save'** button.

It is also possible to export your preset files in order to send them to friends or to simply save them within your DAW session files for easy recall later on. To do this, select **Export Mixer Configuration** at the base of the Save screen.

Loading a Mixer Configuration

To load a previously saved preset, select **File > Open** to bring up the **'Load'** screen.



The previously saved configuration will appear in a list. Select the configuration you wish to use and click Load.

You can also open a mixer configuration directly from your computer's file system by selecting **'Load From File'** located at the bottom of the window.

Store Standalone State

It is possible to save your Software Mixer setting onto the iD48 itself so that the iD48 can be used as a standalone device without it being connected to a computer via USB.

To do this, first setup the software mixer as desired. Now, go to the Menu bar and click 'Setup > Store Standalone State'. The current mixer settings will then be stored to the unit. The next time the unit is powered down and powered up again, it will default to these saved settings.

Please note, its only possible to store one Standalone State at one time and storing a new state will overwrite the previous one.

Menu/Task Bar Icons

MacOS

On MacOS, the iD icon appears in the menu bar in the top right hand corner of the screen. This gives you quick access to various functions of the iD48. Please note that some functions are only visible when the iD48 is connected to the Computer.



Show Mixer

Opens the iD Software Mixer Application. If the mixer is already open, this option will be greyed out. The Mixer cannot be opened unless the iD48 is connected to the Computer.

About iD

Displays information regarding the current version of the iD Software Mixer Application.

Visit iD Knowledge Base

Opens a browser window for the Audient Helpdesk with helpful articles and FAQ's.

Register Product

Will open the registration screen allowing you to register your product to Audient ARC if you have not already done so as part of the initial setup.

Check for Updates

The iD application will check with the Audient update server for any available firmware updates for iD48.

Set Clock Source

Allows you to quickly adjust the clock source between the internal and optical clocks.

Set Loopback Source

Here you can select which Output Channel or Mix will feed the Loopback inputs.

Quit

Fully closes the iD application.

Windows

The Windows taskbar icon has all the same options of the MacOS menu bar icon but also includes some Windows specific options.



Set Sample Rate

Sets the operating sample rate of iD48. 44.1, 48, 88.2 and 96kHz are the four options available.

Set ASIO Buffer Size

Sets the buffer size of the iD48 between 16 and 4096 samples. Higher sizes will take processing load off your computer but will cause increased latency.

Firmware Update

Occasionally Audient will release a firmware update for iD48 in order to address bugs, improve compatibility and add new features. Therefore, you may wish to check periodically for any updates.

This can be done by navigating to the Window menu and selecting **'Check for Updates'**.

The iD Application will then check with our update server if any updates for iD48 are available. If there is an update available then you will be prompted to install the latest version.

Now click **'Next'** and you'll be prompted to stop any playback through iD48. Click **'Update'** and the update will begin. iD48 may turn off and on a number of times.

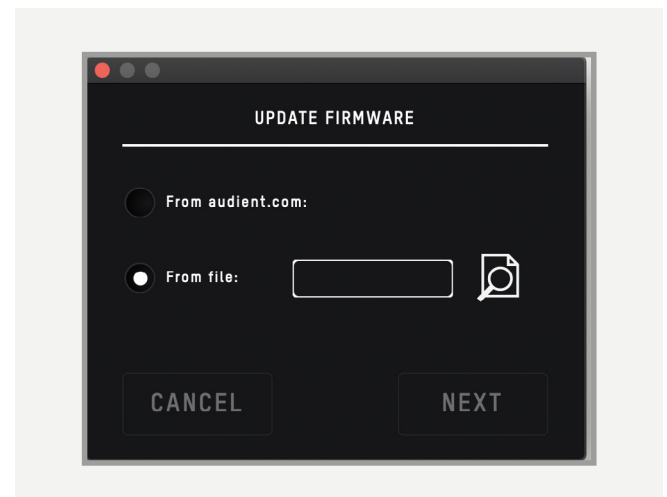

Keyboard Shortcuts

Keyboard Shortcut Index

To allow you to find all shortcuts for the mixer application in one place without having to go through each page of this manual please refer to this table:

Location	Mac	Windows	Description
Faders	Alt + Click	Alt + Click	Resets fader to unity gain (0 dB)
Pans	Alt + Click	Alt + Click	Resets pan pots to central position
Solos	Cmd + Click	Ctrl + Click	Clears all solos if clicking on a solo'd channel Overrides all other solos (for solo exclusive) if clicking on an unsolo'd channel
Meters	Alt + Click	Alt + Click	Clicking on peak hold indicator will clear all clip indicators
System Panel	Cmd + S	Ctrl + S	Save mixer configuration
	Cmd + O	Ctrl + O	Load mixer configuration
View Modes	Cmd + 1	Ctrl + 1	View Mic/Line Input
	Cmd + 2	Ctrl + 2	View Optical (Digital) Inputs
	Cmd + 3	Ctrl + 3	View DAW Mix Inputs
	Cmd + 4	Ctrl + 4	View System Panel

Please check the iD48 page online at audient.com/products/iD48 for the latest iD Application updates.

More shortcuts may be added without notification.

DAW Setup

Pro Tools Setup

Operation with Pro Tools

If using Windows, ensure that you have followed the installation instructions found on **page 10**.

With iD48 connected, launch Pro Tools and ensure that a new session is created at the desired sample rate. If you are using Windows, make sure that you have already set your Latency and Buffer Size settings in the iD System Tray before opening a project. Changing these mid session will result in Pro Tools needing to restart.

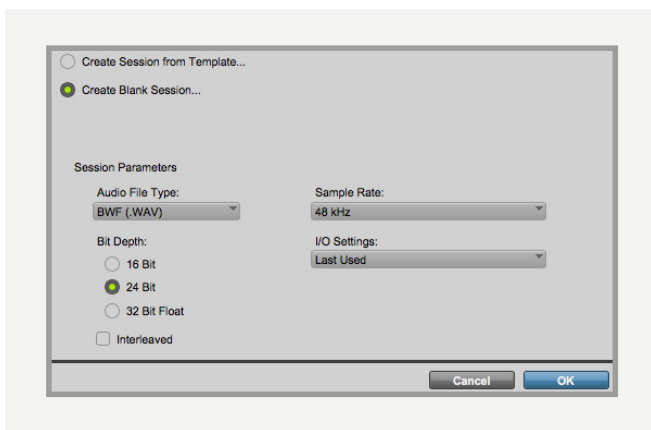

Playback Engine

Go to **Setup > Playback Engine...** and ensure that iD48 is set as the active playback device.

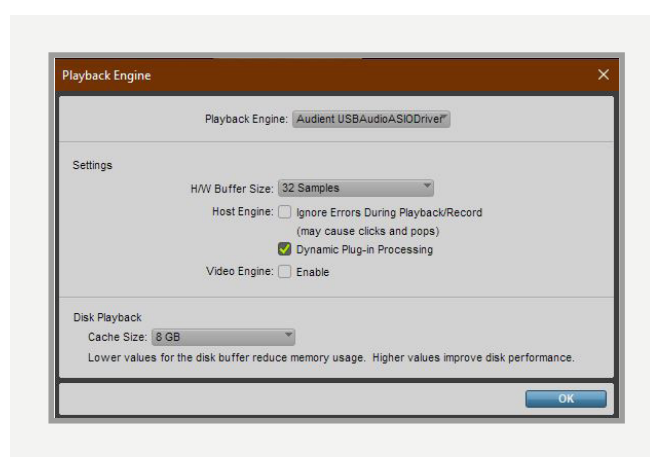
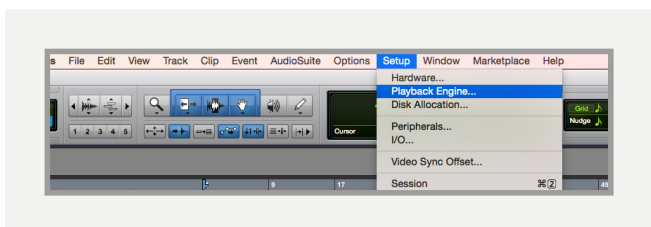

I/O Setup

Go to **Setup > I/O...** to label your inputs and outputs and ensure that iD48 is correctly reporting 24 inputs and 24 outputs to and from Pro Tools.

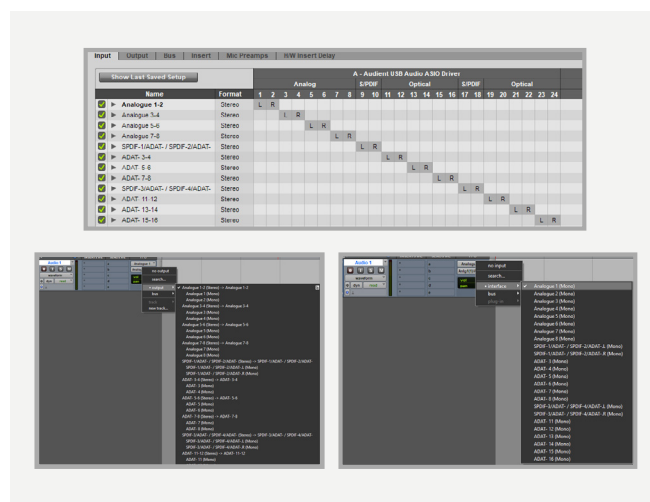

For more Pro Tools information consult your Avid user manuals & documentation.



Logic Pro Setup

Operation with Logic Pro

Once iD48 has been successfully installed following the steps detailed after **page 9** of this manual, launch Logic Pro and check the following:

Logic Pro > Preferences > Audio

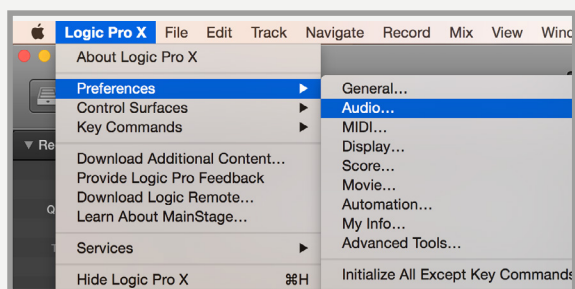

Ensure that iD48 is selected as the active audio device and set the buffer size (to affect system latency). If you are experiencing issues with playback stability and CPU loading, try increasing the buffer size. This appears with **'overload'** errors and/or pops and clicks and distortion in the audio.

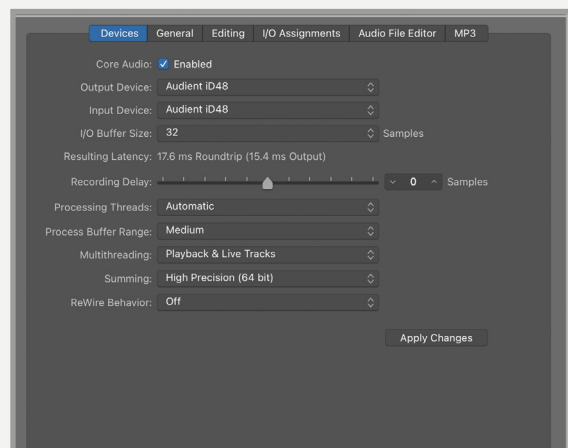

Logic Pro Setup

If you are using the iD Software Mixer Application to monitor input signals while recording, be sure to disable Logic's software monitoring to avoid phasing as the same source will be heard twice with a short delay between the low latency DSP signal and the delayed software monitoring signal.

Assigning I/O

All of iD48's input and output channels will be available to Logic for routing. There are a total of 24 inputs and 24 outputs reported from the driver. You can rename input and output channels to whatever you wish using the I/O label function. This is a great way to keep things organised.

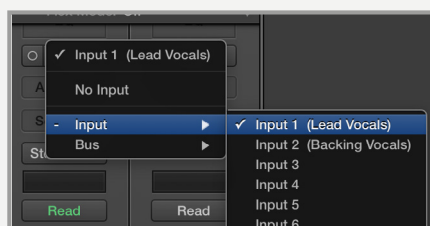

Mix > I/O Labels

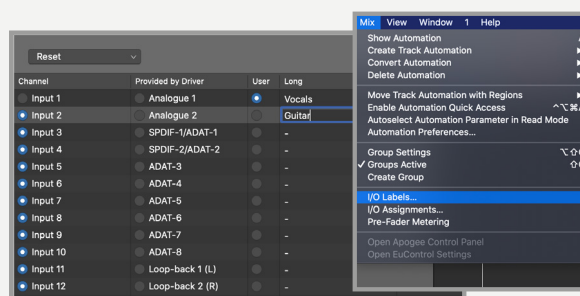

Operation with Logic Pro

If you are using an external clock source (ADAT or S/PDIF) to clock iD48, please ensure that your Logic Pro project is set to the same sample rate when recording and playing back in a session, otherwise things may sound a bit sharp or flat!

File > Project Settings > Audio

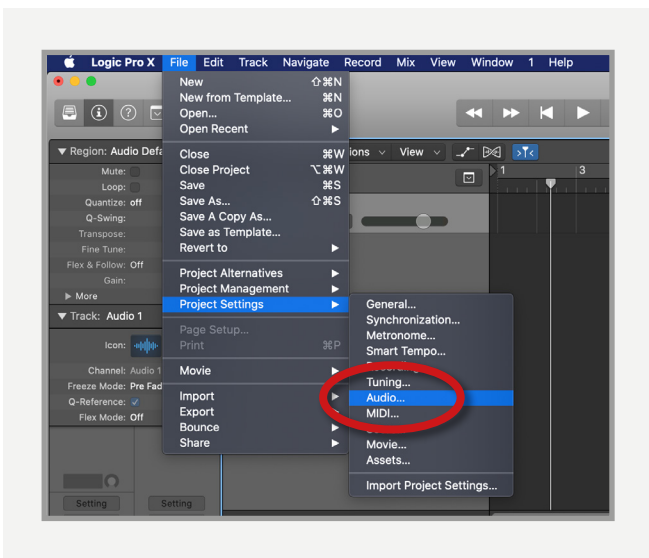

If you are using the internal clock in iD48, setting the sample rate via Logic Pro will update the iD48 sample rate to follow your session.

There may be a slight pause as the system re-clocks. This is normal.

This can be verified in Audio MIDI Setup.

Macintosh HD > Applications > Utilities

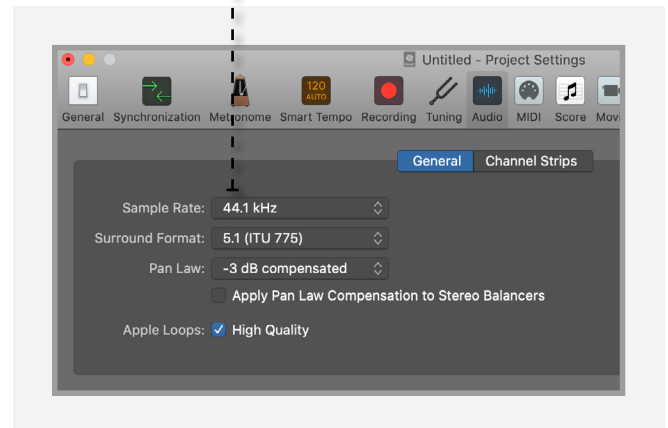
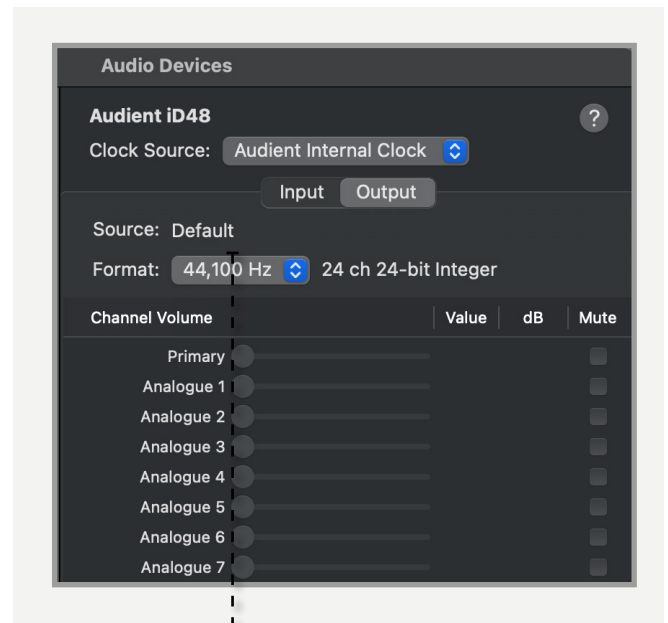

For more Logic Pro information please consult your Apple user manuals & documentation.



Cubase/Nuendo Setup

Operation with Cubase / Nuendo

Once iD48 has been successfully installed following the installation process that can be found at the start of this manual, launch Cubase or Nuendo and head straight for the 'Studio' menu:

Devices > Device Setup...

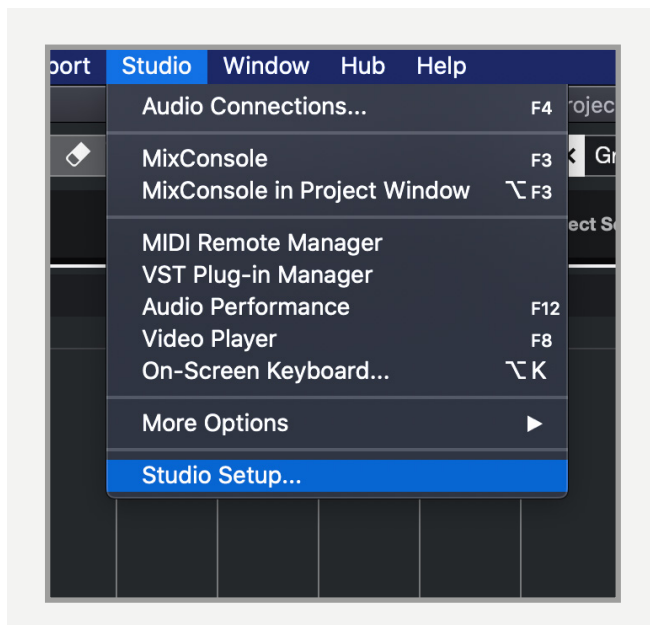

Select 'Audio System' from the list of options.

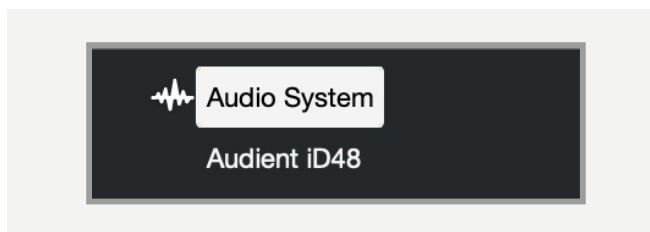

Select 'Audient iD48' in the dropdown menu to ensure that Cubase / Nuendo addresses the iD48 device driver.

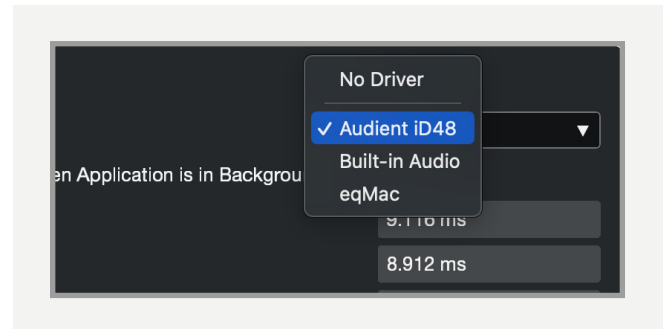

Click on Audient iD48 in the side menu. Here you will see the main iD48 information, where clock sources can be set as well as activating I/O ports. Be sure to click Externally Clocked if clocking from another digital device via ADAT or SPDIF.

I/O ports can be renamed in the device panel such that they better represent what you connect to them (for example Main Monitors, Headphones). This is useful as any names chosen here will be those displayed when assigning I/O on track input/output channel routing.

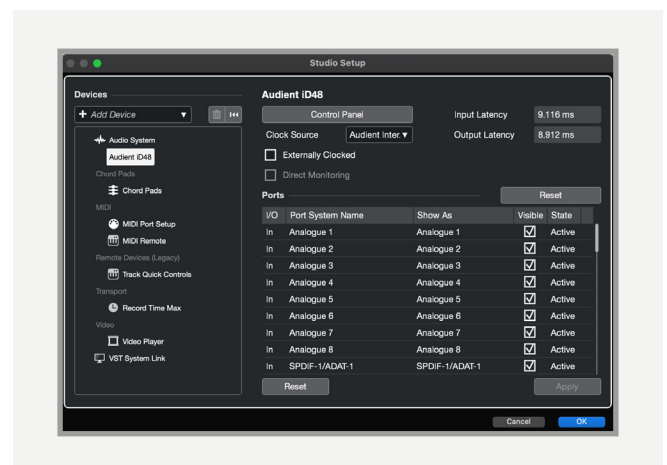



Cubase/Nuendo Setup

Operation with Cubase / Nuendo

Buffer sizes can be set in the control panel within the VST devices display. It is ideal to keep them quite high to reduce CPU loading if you use the iD Software Mixer Application as the input monitoring device while recording.

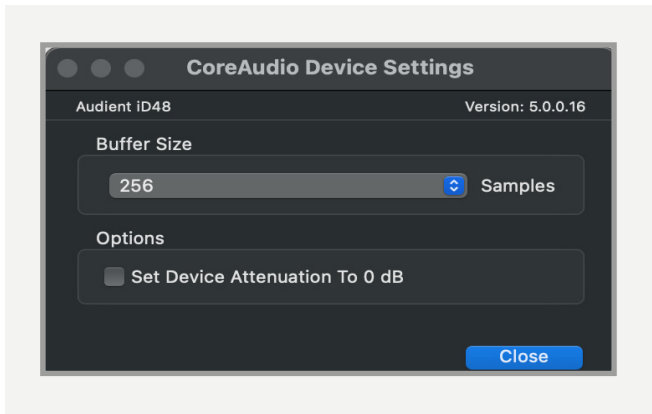

Close the Studio Setup panel and navigate to the Audio connections panel:

Studio > Audio Connections (F4)

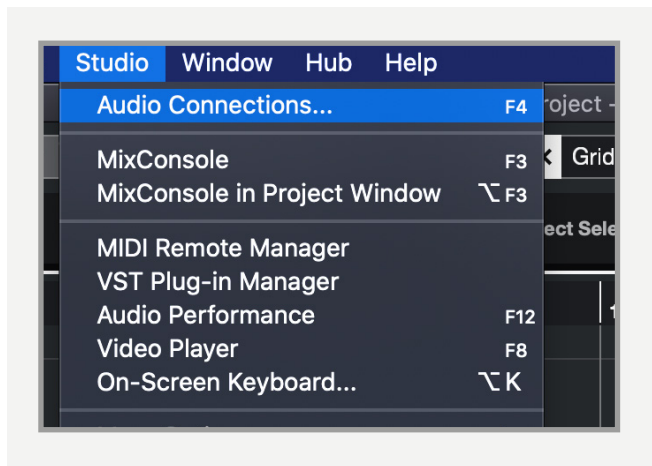

Here you can ensure that all buses have been created in Cubase / Nuendo and therefore all ports are addressable in your session. Add new buses and assign them to the necessary I/O if required.

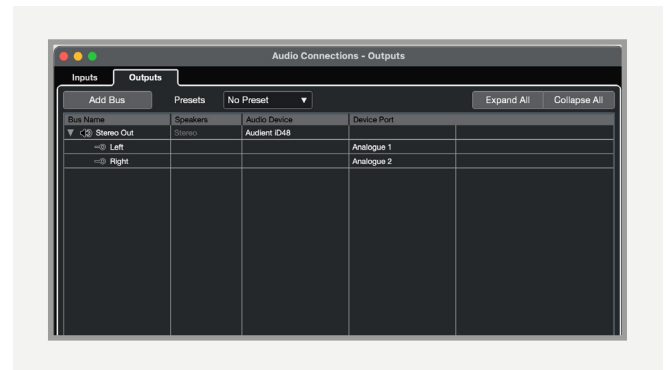

Bus types can be set (mono / stereo) and the VST control room section can also be used. For more information regarding set-up please consult your Steinberg user manuals and documentation.



Ableton Live Setup

Operation with Ableton Live

Once iD48 has been successfully installed following the installation process that can be found at the start of this manual, launch Ableton Live and head straight to:

Live > Preferences > Audio

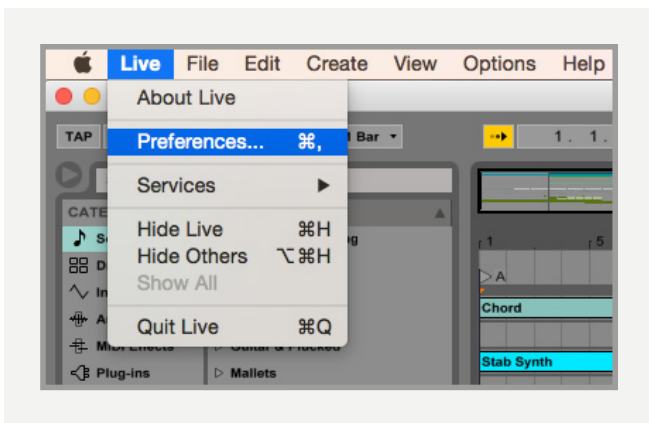

Here navigate to the Audio tab and make sure that iD48 is assigned as the playback device.

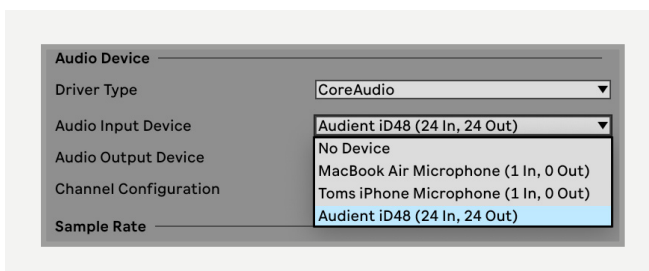

For more information about setting up audio I/O refer to your Ableton Live user manuals & documentation.

In the Live Audio Preference panel you can set an appropriate buffer size (this can be kept high if you are monitoring input signals for recording via the iD Software Mixer Application. Ensure that iD48 reports as a 24 in, 24 out device to Live.

If necessary you can limit the number of I/O channels reported as active inputs (from the driver) in Live by using the input and output config tabs.

This is an excellent feature to help reduce CPU loading if all channels are not required.

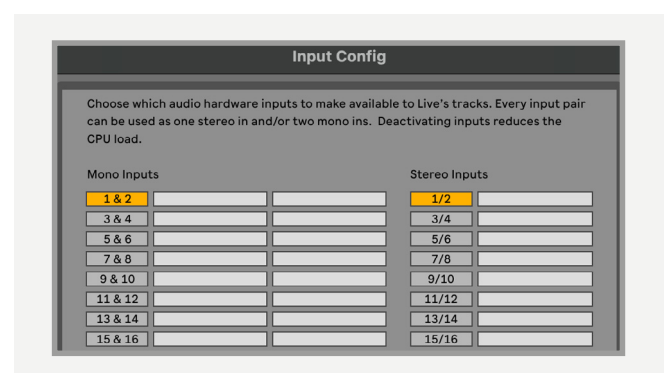

Troubleshooting & FAQ

Troubleshooting

“The unit will not power on”

Double check that the USB cable is plugged in. If it still won't power on, try using a different USB port on the computer and possibly even a different USB cable. If you are using a USB hub, please try plugging iD48 directly into the computer.

“I get clicks and pops on DAW playback”

This is most likely to do with setting the buffer size too low for your computer. This can be caused by running very large projects with a lot of plugins and virtual instruments. Experiment with higher buffer sizes. Typically you want small buffer sizes for tracking or recording software synths to keep the latency low. However when mixing it is fine to set a slightly higher buffer size as latency is not so much of a problem.

“When I connect to my computer, I cannot play any audio out from iD48”

Firstly double check that the USB cable connecting iD48 to your computer is functional and attached at both ends.

Double check that iD48 is set as the active playback device in your DAW and computer:

System Preferences > Sound > Output Tab > Audient iD48 (macOS)

Control Panel > Hardware and Sound > Sound > Manage Audio Devices > Audient iD48 (Windows)

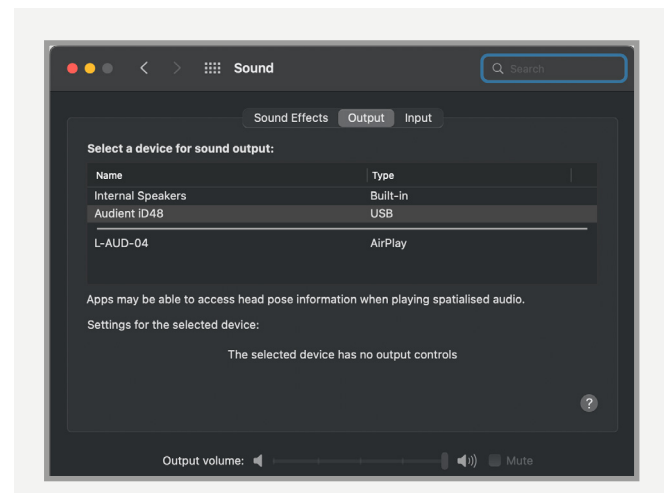

Launch the iD Software Mixer Application to activate communication between your computer and iD48. This only needs to be done once straight after power up. Once iD48 is set to the operational state you desire, you can quit the iD application and it will continue to function as intended.

In the software mixer, locate the DAW channels by pressing the DAW view button and increase the level of DAW 1+2 fader.

Troubleshooting

“I have clocking issues which include iD48 not locking to external ADAT or SPDIF devices or operating at the incorrect rate compared to my session”

If there is an issue with syncing of an external device, the Status LED in the System Panel will be red or yellow. If the status light is red then iD48 cannot detect a clock signal from an external device, and yellow if it can detect a signal at the wrong sample rate.

To change sample rate in macOS, go to Audio MIDI Setup found by navigating to the folder:

Macintosh HD > Applications > Utilities > Audio MIDI Setup

Ensure that Audient iD48 is seen as an audio device (**Window Menu > Show Audio Window**).

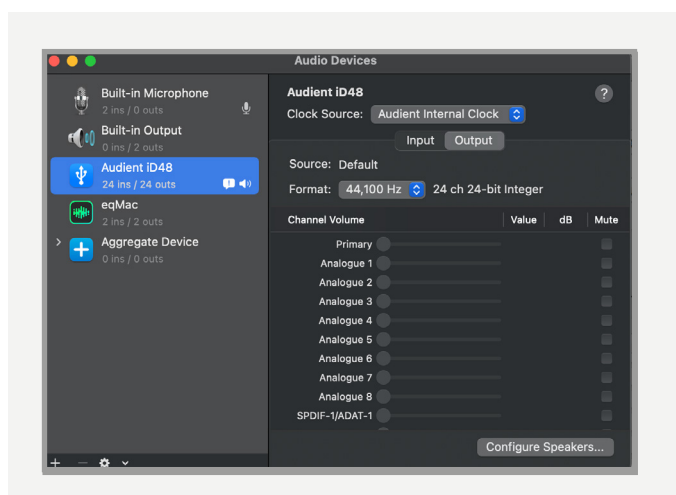

Double check that an appropriate clock source is selected (Internal for master operation), ADAT or S/PDIF clock for external slave operation. Ensure that you see the correct sample rate displayed in the Format drop-down menu.

If you are using Windows, go to the iD icon in the system tray and right click on it. This will bring up some settings including sample rate. Alternatively you can alter these settings in the Setup tab of the iD app.

Change the sample rate to match that of the external ADAT device and session.

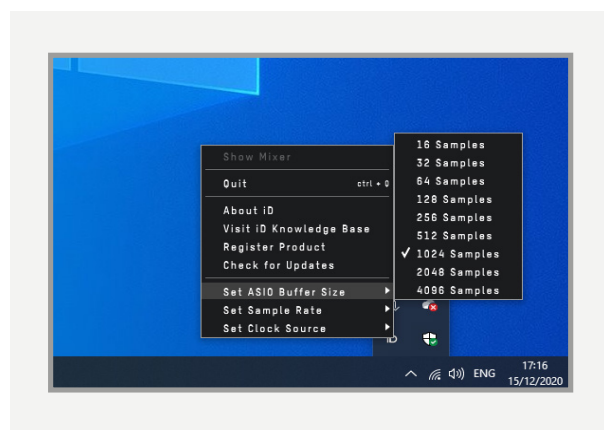

Troubleshooting

“How do I reset the iD mixer application to its default state?”

To reset the mixer application, quit the iD app completely, then navigate to the following folder and delete the state.xml file (it will replenish upon a fresh launch of the application):

Macintosh HD > User > Library > Application Support > Audient > iD > state.xml

(C:) > Users > yourusername > AppData > Roaming > Audient > iD > state.xml

Do not delete the parent folder as this will also contain your iD mixer presets.

“How do I make sure I have the latest version of iD firmware/software?”

To check for the latest updates to the iD desktop mixer application please visit:

audient.com/id48/downloads

download and install the latest driver.

You will be made aware of firmware releases from the iD app when connected to the internet. Please refer to earlier in this user manual for more information regarding firmware updates.

FAQs

For more information and bug support, please search our online Help Centre which can be found here:

support.audient.com

For technical support please create a ticket in our online support system, which can also be found in the support section of our website (see link above).

Technical Specifications



Line Inputs:

LINE GAIN:	-10 to +48dB
MAXIMUM INPUT LEVEL:	+22dBu
THD+N @0dBu 1kHz:	0.0013%, -97dB

D.I / Instrument Input:

D.I GAIN:	0 to +68dB (with 10dB Gain Boost)
MAXIMUM INPUT LEVEL:	+15dBu
INPUT IMPEDANCE:	500k Ω unbalanced
FREQUENCY RESPONSE:	± 0.5 dB 10Hz to 40kHz
THD+N @ 0dBu (1kHz):	<0.06%
SNR:	96dB A-weighted
1/4" JACK:	TIP (Hot), RING (Cold) & SLEEVE (Shield)

Analogue to Digital Converter:

MAXIMUM INPUT LEVEL:	+18dBu (0dBFS digital maximum)
DIGITAL REFERENCE LEVEL:	+18dBu = 0dBFS
INPUT IMPEDANCE:	>10k Ω Balanced
CROSSTALK:	<-118dB @ 1kHz, <-115dB @ 10kHz
FREQUENCY RESPONSE:	± 0.5 dB 10Hz to Fs/2 (Nyquist)
THD+N @ -1dBFS (1kHz):	<0.0003% (-110dB)
DYNAMIC RANGE:	120dB A-weighted
1/4" JACK:	TIP (Hot), RING (Cold) & SLEEVE (Shield)

Digital to Analogue Converter

MAXIMUM OUTPUT LEVEL:	+18dBu (0dBFS digital maximum)
OUTPUT IMPEDANCE:	<100 Ω
CROSSTALK:	<-120dB @ 1kHz, <-115 @ 10kHz
FREQUENCY RESPONSE:	± 0.5 dB 10Hz to Fs/2 (Nyquist)
THD+N @ -1dBFS (1kHz):	<0.00026% (-111.5dB)
DYNAMIC RANGE:	124dB un-weighted, 126.5dB A-weighted
1/4" TRS JACK:	TIP (Hot), RING (Cold) & SLEEVE (Shield)

Word Clock Input/Output:

WORD CLOCK:	44.1kHz to 96kHz
WORD CLOCK INPUT TERMINATION:	75 Ω

Microphone Preamplifier:

MIC GAIN:	0 to +68dB (with 10dB Gain Boost)
LINE GAIN:	-10 to +58dB (with 10dB Gain Boost)
PHANTOM POWER:	48v +/-4v @ 10mA/Channel
MIC EIN:	-127dBu
CMRR:	>80dB @ 1kHz
MAXIMUM INPUT LEVEL:	+18dBu
INPUT IMPEDANCE (Mic)	3k Ω balanced
INPUT IMPEDANCE (Line)	10k Ω balanced
FREQUENCY RESPONSE:	± 0.5 dB 10Hz to 65kHz
CROSSTALK:	<-115dB @ 1kHz & 10kHz
THD+N @0dBu (1kHz):	0.0016% (-96dB)
SNR:	99dB A-Weighted
XLR:	Pin 2 (Hot), Pin 3 (Cold) & Pin 1 (Shield)
1/4" JACK:	TIP (Hot), RING (Cold) & SLEEVE (Shield)
PAD:	-10dB
HPF:	-3dB @ 100Hz, 2nd Order (12dB/Octave)

Headphone Outputs:

MAXIMUM OUTPUT LEVEL:	+18dBu (0dBFS digital maximum)
OUTPUT IMPEDANCE:	<50 Ω unbalanced
CROSSTALK:	<-117dB @ 1kHz, -112 @ 10kHz
FREQUENCY RESPONSE:	± 0.5 dB 10Hz to Fs/2
THD+N @ -1dBFS (1kHz):	<0.00023% (-112dB)
DYNAMIC RANGE:	121dB un-weighted, 124dB A-weighted
MAX LEVEL INTO 30 Ω :	4V Peak, 2.85V RMS, 530mW
MAX LEVEL INTO 60 Ω :	5.82V Peak, 4.12V RMS, 565mW
MAX LEVEL INTO 600 Ω :	8.71V Peak, 6.16V RMS, 126mW
1/4" JACK:	TIP (Hot), RING (Cold) & SLEEVE (Shield)

USB 2.0 High Speed:

NO. OF INPUT CHANNELS:	24 (8 Analogue, 16 Digital)
NO. OF OUTPUT CHANNELS:	32 (16 Analogue, 16 Digital)*
CONNECTOR:	USB Type-C
INCLUDED CABLES:	1m USB 2.0 Type-C to Type-C

*Maximum of 24 unique channels at one time. See page 36 of this manual for more information.

Digital Input:

2 x 8-CHANNEL ADAT:	44.1kHz to 48kHz
2 x 4-CHANNEL ADAT:	88.2kHz to 96kHz (SMUX)
STEREO S/PDIF:	44.1kHz to 96kHz (Stereo)

Digital Output:

2 x 8-CHANNEL ADAT:	44.1kHz to 48kHz
2 x 4-CHANNEL ADAT:	88.2kHz to 96kHz (SMUX)
STEREO S/PDIF:	44.1kHz to 96kHz (Stereo)

DSP Mixer Latency

Round Trip (in-to-out)

44.1kHz	0.344ms
48kHz	0.312ms
88.2kHz	0.188ms
96kHz	0.177ms

Dimensions



Warranty

Warranty Statement

Your iD48 comes with a manufacturer's warranty for three years (36 months) from the date of despatch to the end user.

The warranty covers faults due to defective materials used in manufacture and faulty workmanship only.

During the warranty period Audient will repair at its discretion or replace the faulty unit provided it is returned carriage paid to an authorised Audient service centre. We will not provide warranty repair if in our opinion the fault has resulted from unauthorised modification, misuse, negligence or accident.

We accept liability to repair or replace your iD48 as described above. We do not accept any additional liability. This warranty does not affect any legal rights you may have against the person who supplied this product - it is additional to those rights.

Warranty Limitations

This warranty does not cover damage resulting from accident or misuse. The warranty is void unless repairs are carried out by an authorised service centre. The warranty is void if the unit has been modified other than at the manufacturer's instruction. The warranty does not cover components which have a limited life, and which are expected to be periodically replaced for optimal performance. We do not warrant that the unit shall operate in any other way than as described in this manual.

For the full **'Terms and Conditions'** please head over <https://audient.com/warranty/>

Service

Service Information

iD48 contains no user-serviceable components, please refer to qualified service personnel for diagnosis and repair. Your warranty will be void if you tamper with the device at the component level. If you have any questions with regard to the repair, please contact Audient Ltd.

If your unit is in warranty, please contact your dealer directly for a repair or replacement (at the discretion of the dealer).

For out of warranty repairs, please contact Audient Ltd, after which a **Return Materials Authorization** (RMA) number will be assigned. This number will serve as a reference for you and helps facilitate and expedite the return process. When the unit is returned please include this RMA number along with a description of the fault inside the packaging box.

To request an RMA, access technical support & FAQs, ask for troubleshooting assistance or make an enquiry, please visit: support.audient.com

Audient Ltd
Aspect House
Herriard
Hampshire
RG25 2PN
United Kingdom

Tel: +44 (0) 1256 381944
audient.com

Glossary

A	Amperes
ADAT	Alesis Digital Audio Tape
ADC	Analogue to Digital Converter
DAW	Digital Audio Workstation
ASP	Analogue Signal Processing
CPU	Central Processing Unit
CUE	Artist Headphone Mix
DAC	Digital to Analogue Converter
dB	Decibel
dBu	Decibel referenced to 0.775Vrms = 0 dBu
dBFS	Decibel Full Scale
DC	Direct Current
D.I	Direct Injection (Instrument Input)
DoC	Declaration of Conformity
DSP	Digital Signal Processing
EQ	Equaliser
FAQ	Frequently Asked Questions
FCC	Federal Communications Commission
GB	Gigabyte
GUI	Graphical User Interface
HPF	High Pass Filter
HV	High Voltage
i/o	Input / Output
JFET	Junction Field Effect Transistor
LED	Light Emitting Diode
RoHS	Restriction of Hazardous Substances
RAM	Random Access Memory
S/PDIF	Sony Philips Digital Interface Format
THD+N	Total Harmonic Distortion + Noise
TRS	Tip Ring Sleeve (1/4" Jack Balanced)
TS	Tip Sleeve (1/4" Jack Unbalanced)
USB	Universal Serial Bus
V	Volts
XLR	Extra Live Return, Extremely Low Resistance, Canon X Series, Latching, Resilient Rubber Compound... or make up your own!