

MESA/BOOGIE[®]



Owner's Manual

Hello from the Home of Tone!

Congratulations on your choice of the Dual Rectifier Solo Head and welcome to the MESA/Boogie® Family! The instrument you've selected has a deep heritage that combines the best attributes of vintage tube amplification with pioneering innovation. The bloodline of this iconic circuit traces back to our MARK I™ and the very beginning of Modern high gain guitar amplification, as well as the introduction of "Channel Switching", unveiled to the world for the first time in our subsequent model, the Mark IIA. So congratulations on your choice... hopefully you feel a sense of pride that you're playing an amp like no other, an original in every way! Just like you!

Our 50+ year commitment to excellence along with our solemn promise to you, the musician - to treat you as we ourselves would wish to be treated - guarantees you an experience that will make you feel truly justified in your choice. We're confident your new amplifier will have you smiling and inspired within minutes of plugging in for the first time. ...But what's really gratifying is that you will be finding new and inspiring sounds and enjoying its performance years after the price of admission has faded from memory and the Solo Head continues to unveil its true worth.

It is with sincere gratitude for trusting us with your TONE and our best wishes for all your musical endeavors, that we welcome you home. Should you ever need assistance or guidance we're here to help. With this amplifier you now have an instrument of limitless expression. Our hope is that it takes you and your playing to new and unimagined places throughout your musical journey. From all of us here at MESA Boogie®...Enjoy!



CONTENTS

IMPORTANT SAFETY INSTRUCTIONS	1
PRODUCT COMPLIANCE INFORMATION	2
HISTORY	3
OVERVIEW	4
HELPFUL HINTS	5
FRONT PANEL	9
GAIN	9
TREBLE	11
MID	11
BASS	12
PRESENCE	13
MASTER	14
LED – CLEAN	14
LED – LOOP	14
LOOP ACTIVE MASTER	15
PILOT LIGHT	15
STANDBY	15
POWER	16
REAR PANEL	17
CHANNEL SELECT	17
ORANGE CHANNEL GAIN	17
CHANNEL STYLE SELECT	18
EXT. SW. (External Switch)	19
SPEAKERS	19
SLAVE OUT	19
LOOP SELECT	20
EFFECTS LOOP	20
RECTIFIER SELECT	22
BIAS SELECT	23
FACTORY SAMPLE SETTINGS	24
USER SETTINGS	25
DIAGNOSING PRE-AMP TUBE PROBLEMS	26
SPEAKER IMPEDANCE MATCHING & HOOK-UP GUIDE	28
TUBE GUIDE	33
PARTS LIST	34
SERVICE INFORMATION	35

IMPORTANT SAFETY INSTRUCTIONS

1. Before attempting to use this apparatus, read and follow these instructions for proper use.
2. Keep these instructions.
3. Heed all warnings.
4. Do not use this apparatus near water.
5. Clean only with a dry cloth, do not use any solvent such as benzene, naphtha or paint thinner on apparatus.
6. Do not block any ventilation openings. Install in accordance with manufacturer's instructions.
7. Do not install near any heat sources such as radiators, heat registers, stoves or other apparatus (including other amplifiers) that produce heat. Avoid placing the apparatus in direct sunlight.
8. Do not defeat the safety purpose of the polarized or grounding type plug. A polarized plug has two blades with one wider than the other. A grounding type plug has two blades and a third grounding prong (protective earth connection). The wide blade or third prong is provided for your safety. If the provided does not fit your outlet, consult an electrician for replacement of obsolete outlets.
9. Be sure that the amplifier's rated power supply voltage and frequency matches the voltage and frequency of your power source BEFORE connecting amplifier to the power source. The amplifier's rated power supply voltage and frequency are clearly indicated on the back panel near the power inlet, and the power cord's plug should match the power source in your region.
10. Protect the power cord from being walked on, pinched, or from excessive stress, particularly at the plug and attachment point of the apparatus.
11. Only use attachments and/or accessories specified by the manufacturer.
12. Refer all servicing to qualified service personnel. Servicing is required when the apparatus has been damaged in any way, such as the power plug or cord is damaged, liquid has been spilled or objects have fallen into the apparatus, the apparatus has been exposed to rain or moisture, does not operate normally or has been dropped.
13. To ensure proper ventilation, ensure that there is a minimum of 4" (10cm) of space at the rear of the apparatus. The ventilation should not be impeded by covering the ventilation openings with items such as newspapers, cloth, tapestries, curtains, etc. Do not impede ventilation by placing objects on top of the apparatus which extend past the rear edge of the cabinet.
14. No naked flame sources, such as lighted candles or oil lamps, shall be placed on the apparatus.
15. The apparatus shall not be exposed to dripping or splashing, and insure that no objects filled with liquids, such as vases or beverages, are placed on the apparatus.
16. The AC plug is the mains disconnect, the plug shall remain accessible after installation.
17. **WARNING:** To reduce the risk of fire or electric shock, do not expose this apparatus to rain or moisture.
18. **WARNING:** Do not defeat the safety grounding pin on the power cable, it is there for your safety.
19. **WARNING:** Do not open or perform any internal modifications on this apparatus.
20. **WARNING:** Do not attempt to repair the apparatus, or replace parts within it (except where this manual provides specific instructions directing you to do so). Refer all servicing to your retailer, the nearest authorized Mesa Boogie Service Center, or authorized Mesa Boogie distributor in your region.
21. **WARNING:** Always disconnect the apparatus from the power source before changing fuses, tubes or removing the chassis for service. Use only the same type and rating as specified on the back of the apparatus when replacing a fuse.
22. **WARNING:** Disconnect apparatus from the power source during a lightning storm or when unused for long periods of time.
23. **WARNING:** This apparatus is heavy. Insure that the apparatus remains stable after installation.
24. **WARNING:** In areas where children may be present, use additional precautions as needed to protect the children from the hazards presented by the unit. This includes risk of electric shock, burns and toppling over.
25. **CAUTION:** This apparatus contains hot components and surfaces. Avoid direct contact with heated tubes and other components. Insure that any factory installed guards remain installed.
26. **CAUTION:** Avoid contact with moving fan blades that may be present within the apparatus or cabinet.
27. **CAUTION:** tube envelopes are glass and can present a hazard if broken. Always turn apparatus off, disconnect from the power source, and allow to cool before changing tubes.
28. **CAUTION:** To avoid damaging your speakers and other equipment, turn off the power of this and all connected equipment before making or changing connections. power apparatus up with the volume levels set to minimum, and slowly increase to desired level.
29. **CAUTION:** Always insure that the proper speaker load is connected to the apparatus before operating the apparatus. Failure to do so may cause damage to the apparatus.
30. **CAUTION:** Do not use excessive force when handling cords, jacks, buttons, switches and controls. Never unplug the apparatus from the power source by pulling on the wire, use the plug body.
31. **CAUTION:** This apparatus, in combination with speakers and/or headphones, may be capable of producing sound levels that could cause permanent hearing loss. Do not operate for a long period of time at high levels, or at a level that is uncomfortable, without hearing protection. If you experience any hearing loss or ringing in the ears, you should immediately stop using the apparatus and consult an audiologist.

PRODUCT COMPLIANCE INFORMATION

Suppliers Declaration of Conformity for 90s Dual Rectifier Responsible Party

Gibson
209 10th Ave S Ste 205,
Nashville, TN 37203
United States
Telephone: + 1 615 933 6000

HISTORY

Congratulations on your choice of the 90s Dual Rectifier®, and Welcome to the MESA Boogie Family!

The Dual Rectifier Solo Head's release in 1992 marked a new paradigm in high-gain Heavy guitar. Its sound and impact on the generation that used it to define what rock music would become over the next decade and beyond was as sweeping as it has been lasting. Thirty-plus strong years later, it remains one of the most recorded and imitated tube amplifiers, as well as arguably the most "modeled" in today's digital amp landscape, with no signs of slowing.

With harmonic-laden gain and ominous low end, the "Recto®" sound became the foundation for radio-worthy songs whose main source of propulsion was huge Crunch rhythm, searing Leads, and thick overdrive octave hooks. Its options for tuning power and sound made it a go-to for anyone needing maximum width and girth in a 3-piece scenario, while its looks provided an aggressively styled backdrop perfect for head-banging artists and audience-born mosh pits.

Delivering a "feel" as empowering as its sound, the Rectifiers provided an inspirational ease of playing that supported and elevated proficiency and creativity, which is rewarding and addictive. These many attributes have kept players of all genres circling back around to the Recto's intoxicating blend of experiences, from aural to tactile to emotional.

Groundbreaking in feature set, appearance, and sound, the diamond plate adorned "statement" went on to rule radio with top artists utilizing its menacing sound on hits destined for defining moments in rock. Today, its sonic footprint remains at the top of rock playlists and it still resonates strongly for many as great 90s music circulates relevantly thirty years later.

With all reverence for this icon and its effect on the musical era it arose from this classic 90s Dual Rectifier gives those wanting the original Solo Head's Vintage/Orange and Modern/Red overdrive sounds a chance to own the classic brand new, along with an improved CLEAN Mode. A flattering tribute and upgrade to one of the most iconic tube amplifiers of the modern era, this 90s Dual Rectifier creates the opportunity for a whole new generation of players to sound as big and Heavy and be as inspired by Tone as any who crafted the music they may have grown up listening to.

FRONT VIEW: 90s DUAL RECTIFIER



REAR VIEW: 90s DUAL RECTIFIER

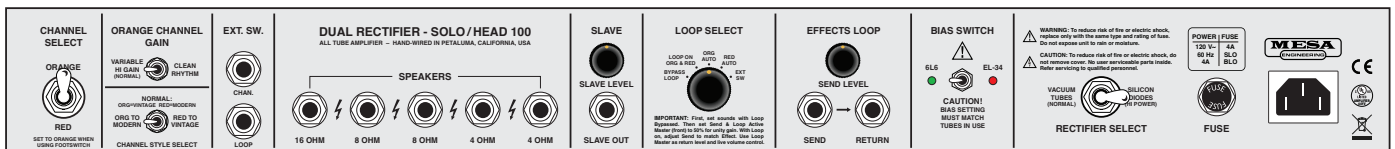

OVERVIEW

This model revisits the original 2 Channel layout based on two overdrive Modes: Vintage /Orange and Modern/ Red. The colors refer to the LEDs that illuminate on the Channels that are wired default/normalized to each of these sounds. It also features an improved CLEAN Mode in the Vintage/Orange Channel, selected via the "ORANGE CHANNEL GAIN" select switch on the Rear Panel.

We've included "Channel Cloning" from the 90s originals with the CHANNEL STYLE SELECT switch on the Rear Panel, enabling you to dedicate the entire amp/both Channels to one or the other of the sounds/Modes should your music require more focus on one or the other. Switch between two settings of the same preamp/ amp combination, i.e., two different settings of the Vintage/Orange Mode or two optimized settings of the Modern/Red Mode. The Presence settings will dial up a bit differently due to the difference in the architecture of the two circuits in the power section, but otherwise, the Channels will be nearly identical when "Cloned."

The Power Section still offers the RECTIFIER SELECT switch, offering a choice of Silicon Diode or Tube Rectification. DIODES are the tighter, faster, more articulate choice, and TUBE offers a looser, slower, warmer alternative that is very cool for single-note soloing and harmonically layered chording.

Next door, the BIAS SELECT allows you to run the stock complement of 6L6 power tubes or swap in a quartet of EL34 for a more "Brit" response with a trimmed low end and more harmonic influence in the top end. Always make sure the BIAS SWITCH setting matches the tubes in use!

The on-board Variac is still here but now resides on the Front Panel POWER switch in the form of a 3-position toggle labeled "BOLD/SPONGY," awaiting your need for the ultimate "Brown sound" and the most sag possible from the power section. BOLD (switch up) delivers the normal 117 AC voltage to the amplifier, creating the maximum headroom and authority. Off = Center and SPONGY (switch down) select a reduced voltage option that lowers voltage across the entire amplifier and delivers a looser feel with more sag, scooped midrange, and a greater emphasis on upper harmonics.

A deviation here from the original 90s run of Solo Heads lies in the Effects Loop configuration. The originals were wired with a Parallel Effects Loop, as that was the call of and for the times. While that is one way to go and offers potential advantages in some situations, it came with potential pitfalls for many players who didn't need the added complexity. We have done many models since that time with Series Effects Loops and have perfected their performance, tuning them to be very transparent and accommodating, and we now greatly prefer their superiority in most applications. At this point, we feel confident in stating the Loop works much better wired in Series fashion and provides even better tonal results, but also a more seamless interfacing experience with fewer hassles and/or level matching issues for most players. We still include a way to bypass it for purists, but most prefer the Loop engaged all the time. We've also retained a SEND LEVEL control for optimizing your levels and have included the original's LOOP SELECT Rotary control for application of the Loop where desired, along with the LOOP ACTIVE MASTER control on the Front Panel to make RETURN stage matching and on-the-fly global volume adjustments quick, easy, and accessible.

The SLAVE Output and LEVEL control remain, in part as a tribute to days gone by, but they also provide an important feature in today's prevalent use of Impulse Response technology in direct recording and even some live situations where in-ear monitoring is in use. While the Rectifiers do not incorporate a compensated DI for direct recording, this SLAVE Output DOES provide an uncompensated feed for/to an IR reader. Again, the SLAVE is a non-compensated output containing the ENTIRE amplifier's sound, both preamp and power section, in its raw, unfiltered form with none of the roll-off and shaping that a speaker and cabinet do. This does not sound like what you are accustomed to using cabinetry, but it is exactly what IR readers/players want to see as a feed signal.

And should you ever need to "amplify your amplifier" for big venue use, the SLAVE output and SLAVE LEVEL are there for their original contribution. You can drive additional cabinetry by feeding the additional amplifier's power section(s) from the SLAVE, enlarging your sound exponentially. Or you might want to create a dry/wet/wet

rig using a stereo power amp – or two amplifier Heads – fed by an effects rack’s stereo outputs and sourcing signal from your main (this) amplifier’s power section. Either way, the SLAVE and SLAVE LEVEL provide the flexibility to cover these needs.

As always on Rectifiers, Speaker Output taps for 4, 8, and 16 Ohm impedance loads are included to ensure the best performance, regardless of your cabinetry preferences.

Another feature that may be valuable is included, just so your amplifier is always ready to go big when you are. The EXTERNAL SWITCHING jacks provide an interface for remote triggering of the Channels and Loop should you ever put your Recto in a custom rack rig and/or control it with a Master External Midi Switcher. These jacks accept tip-to-ground logic and will facilitate the “one button” approach, allowing your amplifier and all your processing to be controlled via MIDI (or some other messaging) under “programs.”

And as on every MESA, the Manual CHANNEL SELECT allows for switching the Channels when you don’t have or don’t need the Footswitch.

Please take time to read through this Manual and Operating Guide at some point so that you can gain the understanding to gain the most from your gain. Seriously, though, learning how the controls and features interact to produce the sounds you want will allow you to get the most from your new instrument, which is an amplifier. If this is your first MESA, then perhaps calling an amp an instrument is foreign to you. However, we here at MESA designed it with exactly that intention. This amplifier IS an instrument, and it has all the same interactive response, nuance, and intrinsic value of a fine musical instrument. So let it take you and your playing where it will, and most of all, Enjoy the Ride!

From all of us here at MESA/Boogie, Thank You for putting your trust in us to be your amplifier company and Welcome to the Mesa/Boogie® Family.

HELPFUL HINTS

- **Warm-Up!** Always begin playing sessions with the following Cold Start Procedure at Power Up:
 1. ***With the STANDBY in the OFF position, Flip POWER to ON***
 2. ***Wait at LEAST 30 Seconds.***
 3. ***Flip STANDBY to ON ...and Enjoy!***

Following this Cold Start Procedure will help ensure reliability and prolong the toneful life of your tubes, especially the power tubes. Like an incandescent lightbulb that has a filament, much wear and stress on your tubes occurs at the instant of power up from a cold state. Much like a dimmer on a light switch being set low when you first flip it on, the STANDBY being OFF at the instant of power up – and for at least 30 seconds thereafter – allows for a warm-up period and minimizes the shock on tube filaments when they are cold. If you follow this procedure every time you power up your amplifier, the likelihood of experiencing tube issues will decrease, and their longevity will increase.

- **FOOTSWITCH!** To use the MESA Footswitch to access the Channels, connect the Footswitch via the supplied Cable to the Front panel jack labeled FOOTSWITCH. Make sure the Rear Panel CHANNEL SELECT toggle switch labeled “ORANGE/RED” (Far Left when facing Rear Panel/straight back on Right when facing Front Panel) is in the upper/ORANGE position to use the Footswitch. The Footswitch will not select the Channels if the switch is in the lower/RED position.

When the Footswitch is not in use or unavailable, use the Rear Panel CHANNEL SELECT switch to engage the Channels. This switch provides easy access to the Channels for recording sessions when you might have the Head in the control room and Cabinets in another tracking room, or any time you don’t have or

need the Footswitch connected.

- **Travel Safe!** It goes without saying and is common sense, but using the provided Slipcover and securing it in place with the Handle Flap, as well as securing the amp itself and preventing it from sliding around in your vehicle and hitting something or something doing the same to it, is essential and critical to maintaining your amplifier and your safety.

Always secure your amplifier (and Cabinet), along with any accessories, in transport, and make sure it can't slide or move/fly around. Make sure other objects cannot tangle with or come in contact with the controls. Foam is one great way of protecting the amplifier and the surroundings in travel, but regardless of the method, remember your amplifier is heavy and can be damaged – and do damage – should it be allowed to move around during transport.

- **Respect Your Ride!** Much like a race car, your new amplifier is a high-performance vehicle capable of gain and volume beyond what most traditional amplifiers can deliver. The message here is that there is far more available than you will likely ever need, so applying wisdom in your application is warranted.

Just like with a race car, it is unwise to jump in and slam the accelerator down to the floor. You would likely run into trouble fast! The same concept applies to the GAIN and MASTER control(s) here on your amplifier. Extremely high settings of the controls, especially in combination, leave you more prone to experiencing microphonic tube annoyances such as ringing, squealing, rattling, or other forms of tube noise. This can be avoided by more sensible settings of these controls, and in a greater sense, all of them.

Thankfully, we've had decades navigating these upper realms of performance, and your new amp benefits from that experience. Still, as you will hear many times throughout this manual, you don't need to set the controls in their highest range to achieve great performance, and in fact, ignoring that practice may lead to tonal compromises or annoyances that can otherwise be easily avoided.

- **Power Integrity and Protection! Important! Never alter your Power Cable!** Be sure to connect all three terminals of your Power Cable, including the Ground! Failure to do so, and/or modifying your Power Cable in any way – including using a 3-2 Ground Lift Adapter – may void your Warranty and increase the risk of Electric Shock. Always connect your amplifier to a 3-Pin Grounded AC Wall Receptacle with the proper AC Line Voltage present (117 Volts US/Domestic).
- **Protect Your Tone!** It's always a good idea to use a high-quality Shielded Instrument Cable of a reasonable length – say no more than 15-18 feet – for your instrument to amplifier connection, unless you plan on using a Buffer. This will ensure the best sound and prevent loss of top end due to increased cable capacitance that can rob your instrument signal of its integrity.
- **Effects; Front or Rear? Depends on the Gear!** Effects and processors are most often best suited for use in one of two different places in your signal chain: 1) Between your guitar and your amplifier's Input, or 2) near the end of your (preamp's) signal path in the amplifier's Effects Loop.

Here are some general guidelines/hints as to what most often goes where for the optimum performance from your pedals and effects processors, as well as your amplifier:

1. **Front:** Compressors, Wah pedals, Envelope Followers/Filters, Octave pedals, Boost pedals, some EQ pedals, Overdrive, Distortion, and Fuzz generally want to be in-line between your Instrument and the Amplifier's Input, i.e. "in the Front."
2. **Rear:** Time-based effects such as Reverb, Delay, Chorus, Phase, Flange, most Harmonizers, and most EQs usually work best in the amplifier's Effects Loop with the SEND feeding the first Effect's INPUT and the RETURN accepting the last processor's OUTPUT. In other words, "in the Rear."

The above are merely suggestions and general schemes. You may find your preferences differ from these, but often these categories of processors and effects should work well in these locations in your signal chain if they are of good quality.

NOTE: Many reputable cable manufacturers make cable bundles that support this split wiring (Front/Rear) format and make it much easier to route your processing in this way. It is most often referred to as the “4 Cable” method of interfacing effects. Looking into a bundle like this may save you time and help you get optimum performance from your amplifier and effects.

NOTE: Ultimately, anything and everything you put into your signal path has the potential to impact your Tone. We recommend using good-quality processing and trying it with your amplifier, if possible, before committing to a purchase. Pricing can be one indicator of quality, but not always of compatibility, so the best way to assess an addition to your signal path is to try it with your amplifier and let your ears and hands be the judge.

- **Straight-In is Best – Buffer the Rest!** When using a Pedal setup on your front end (between the guitar and the amp’s INPUT), keep in mind that EVERYTHING you put in your signal path affects the sound. You’ve chosen a high-end, professional instrument in your new amplifier and it stands to reason that your guitar is likely of similar quality. Try not to compromise that discernment by placing devices that are of lesser integrity in the signal path. If you do have a string of pedals you rely on for boost, overdrive, wah, compression, and other effects on your front end, we suggest employing a Buffer in your signal chain to make sure you keep levels and impedances at their optimum and avoid excess cable capacitance created in all the additional wiring. Buffers are small, affordable devices readily available through many reputable companies, including MESA/Boogie. Your Tone will be well-served if you employ one to mitigate any loss incurred by the addition of your front-end processors and subsequent cabling.
- **Loop Insurance!** Cabling quality is also important “in the Rear” of your signal chain in the Effects Loop. Here as well, use good quality shielded audio cable to prevent degradation in your Tone and possibly excess noise. Even though the signal is buffered in the Effects Loop, it is still a good idea to use good-quality cabling of the shortest length possible. This patch point between the preamp and power section is a sensitive place in the amplifier’s circuit and anything you introduce here has the potential to change the sound.
- **Processing: Choose Wisely!** Select the pedals and processors you wish to interface with the Effects Loop with the same discretion used on your front end (at the Input).

Since the patch point between the preamp and power amp is a sensitive place in the signal chain and the quality of what you place at this junction will ultimately affect the signal for better or worse, it’s important to match your amp’s level of quality with processors of similar quality. Price is somewhat an indicator of quality, but not always as indicative of compatibility.

We suggest taking whatever processors you intend to buy home to try or taking your amplifier to the shop selling the processor and trying it in the Loop of your amplifier to determine whether it’s a good match. With short to reasonable-length cables, you should hear very little difference once the Input (and possibly Output levels as well) on the processor are set to achieve unity gain (the same gain level/no volume difference with cables inserted and removed from the Effects Loop’s SEND and RETURN jacks).

If the level drops when you insert the cables, increase the levels on the processor. If the level goes up when the processing is introduced, reduce the levels on the processor. Ideally, there should be no difference in Tone or levels when the cables are inserted and removed – this is “unity gain” and represents little to no signal loss.

This step (trying before buying) isn’t always easy or convenient, but you probably didn’t choose your amplifier based solely on convenience either; likely more for its inspiring Tone and performance. Discerning choices in your outboard gear will honor that decision and keep your amplifier sounding and performing

at its optimum capability.

- **Stay Connected!** Sound waves transmit through objects and your body. This can be a good thing in the case of an electric guitar, as those sound waves affect how the instrument feels in your hands. It is preferable to have at least one speaker cabinet sitting on the floor you are standing on while playing. The transmission, and especially of the low end, will affect how the instrument feels to play. Keeping one speaker cabinet on the floor helps ensure the instrument, the amplifier, and your body are connecting and resonating in a harmonious, sympathetic feedback loop that makes playing your amp more emotionally satisfying and ultimately more expressive.

NOTE: The exception to this advice above can be when you are playing on stages with many live microphones cranked up and/or when there are large monitors and subwoofers nearby (especially if too big and too many), or when the stage itself is extremely resonant in the lower frequencies. In any of these cases, it may be necessary to lift your cabinetry off the floor, or sometimes even off of a drum riser, to de-couple it from the floor and even your instrument to prevent feedback or “runaway resonances.” This type of feedback usually occurs in the low end. In some cases, and in certain environments, alternatively, you can trim the low end in the live microphones via the mixing console and then be able to keep the amplifier coupled to (sitting on) the floor or stage. Having some coupling through the floor will likely always feel better to you and your hands.

- **Speak Accordingly!** Cabinetry and speaker choice are hugely important to achieving the sound you want and optimizing the amplifier to styles of music you may wish to play. Speakers have a giant impact on the sound, as does the cabinetry they are loaded into, so take this into account when searching for sounds with your new amplifier. Keep in mind you can add or substitute Extension Cabinets to tune your amplifier to the stylistic application or environment, and tune the sound physically to best fit the music and/or venue(s) you most often play in.
- **Open-back** cabinetry leans toward beautifully balanced, open-sounding clean sounds, adding three-dimensionality and clarity in the top end and a low-end character with more “air” in the mix.
- **Closed-back** cabinetry adds focus and a tighter tracking element, especially in the low end, as well as definition and punch in the rest of the spectrum. Some players use a combination of both (closed and open-back) at the same time to achieve a balance of the two different characteristics. Others lean one way or another in accordance with their favored musical style, sounds, or favorite Artists.

We suggest, at some point, exploring the options in each category to see if perhaps one or the other of these differing designs unlock sounds and response characteristics you’ve imagined, but may have not yet attained. We feel all our cabinets offer exceptional performance in their category, so whatever you have now, if it’s a MESA Cab, you’ve got Tone. At some point, though, you may want to refine or radically change your sound, and perhaps require something that the “physical” impact and dimension of different cabinetry can achieve for you.

- **Coverage Beats Power!** Adding additional cabinetry increases your (stage) volume and coverage far more than increasing wattage in an amplifier’s power section. If you need to hear yourself better, try adding an Extension Cabinet.

NOTE: When adding Extension cabinet(s) make sure you keep the Impedance Load on your amplifier correct. Most MESA Cabinets are wired for an 8 Ohm Load. Mesa Cabinets built post mid-90s feature a Parallel Jack on the Cabinet’s Rear Jack Plate and this is one way to connect an additional cabinet. When doing so via this method, be sure to move the cabinet connected to your amp’s 8 Ohm Speaker Output over to the 4 Ohm Speaker Output (assuming the cabinet you are adding is also rated at 8 Ohms).

You can also connect two 8 Ohm Cabinets independently, each to one of the two 4 Ohm Speaker Outputs on your amplifier (and most MESA amps). In either case, the two 8 Ohm Cabinets together create a 4 Ohm

Load, so you want to connect them to the 4 Ohm Speaker Outputs in one of the two ways listed above.

Some MESA amplifiers have only one 4 Ohm Speaker Output (for some, to accommodate the internal Silent Load feature). You can still connect two 8 Ohm Cabinets to this single 4 Ohm Speaker Output, but you will need to do so either with the Parallel Jack on the rear of your MESA Cabinet or if your cabinet is an older MESA cabinet or another brand that does not have a Parallel Jack, an unshielded “Y” Speaker Cable. You can use a Shielded Cable in a pinch, however, shielded instrument cables usually have smaller wire, and when it comes to Speaker Cables, thicker gauge wire is preferable.

- **Less Can Be More!** When it comes to the GAIN, MASTER, and TONE controls, restraint can be your friend and your key to great Tone.

Your amplifier was designed to deliver great performance across a wide range of settings and musical styles and much of that performance can be found in the median ranges of the controls. Unlike some amplifiers that are historically known for sounding good only at extreme settings, MESA amplifiers are designed such that the controls are very active and deliver big sonic changes with subtle movements of the controls.

We suggest starting in the middle ranges or sweet spots of the controls, including the GAIN controls, and adjusting from there to find the sounds in the Channel that suit your particular needs. This will do two things: One; it will mean you have plenty of room for adjustment in either direction and two, it will reduce the likelihood of excess noise being introduced and help you maintain an optimum noise floor.

Granted, there will be times when you will need to run the controls closer to their maximum (or minimum) settings, and this is fine and will not hurt your amplifier. However, if you explore the median settings on the controls first and learn their tapers, their frequencies, and their overall range, you will better know which ones can accommodate higher settings and which you may want to veer away from settings at the extreme ends for musically relevant reasons, and also to keep the stress on tubes reasonable so they have less chance of microphonic tendencies or instability.

FUSE Replacement

The Mains Fuse is there to help protect your amplifier from spikes or power surges in the AC Line, faulty or arcing power tube issues, and other forms of duress your amplifier might encounter. If the Fuse should ever blow, ALWAYS replace your Fuse with the same type and power rating Fuse. In the 90s Dual Rectifier 100 Watt model the Fuse is a 4 Amp SLO-BLO type Fuse.

FRONT PANEL

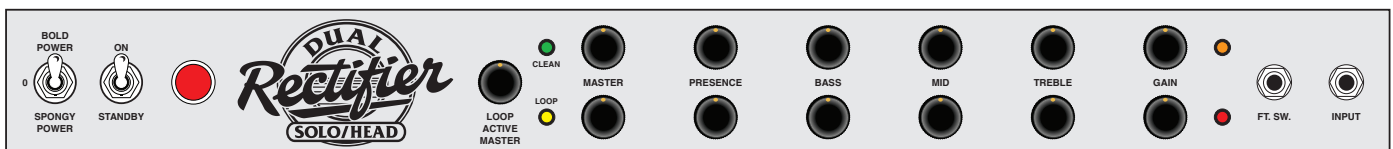

GAIN

As with most tube circuits, and especially those dedicated to guitar, the “GAIN” control adjusting the Input stage (and sometimes additional stages) is the most significant control for both gain structure/character, as well as tonal “casting” and dynamic response. Regardless of what style you are looking toward, the setting of the GAIN control determines the character and shape of the sound, clean or dirty, bright or dark, thick or trim. That’s because as natural tube saturation increases, the top end recedes and is traded for girth and warmth and a slightly more compressed feel, which often leans appropriately toward the applications and playing styles where more gain is used. In other words, cleaner sounds usually benefit from the lower GAIN setting’s brightness and inherently trim EQ, while higher gain sounds benefit from the receding top end and added warmth as more tube saturation compresses, fattens, and darkens the character at higher GAIN settings.

To simplify, let's look at the GAIN like this:

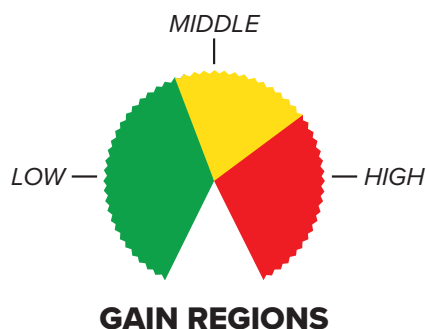

By itself, the GAIN Control has basically three regions:

Low (7:00 - 11:00) provides the cleanest, least saturated sounds, and in this region, the sound will be brighter and contain more upper harmonics and less low end, lending a tight, trim character to the sound. This can be good for tight Rhythm comping in the CLEAN Mode of the ORANGE/VINTAGE Channel, and some cool blues-inspired single note sounds in "VARIABLE HIGH GAIN." In the RED/MODERN Channel, this region can be good for Classic Rock inspired Rhythm parts that need a fast response time and urgent sonic attack character.

Middle (11:15 - 2:00) enhances the saturation and replaces some of the upper harmonics with a richer, warmer quality and a fuller bottom-end response. Not yet fully saturated, this region is the easiest place to get a great sound in all three Modes of the two channels. This region contains many of the Recto's best sounds...especially for soloing due to the crucial blend of an expressive attack combined with ample sustain.

High (2:15 - 5:00) saturates the signal more completely and enhances low and low mid frequencies. While this region provides the maximum saturation and, therefore, sustain, it also compresses and softens the attack characteristics. For this reason, we suggest using this higher region of the GAIN Control sparingly and only when maximum sustain and/or overdrive is needed as it reduces the dynamic range and, hence, some of the expressiveness possible.

NOTE: Due to the Recto's extreme gain potential, the highest regions of the GAIN Control may possibly push some preamp tubes past what they can handle, producing microphonic squealing. While we screen and test the tubes your amplifier was shipped with and the tubes in your amp passed our rigorous test, we can't predict how the tubes will respond over time when exposed to extreme gain settings. Your tubes are warranted for a period of 6 months under normal use, but you can save yourself the present and future inconvenience of having to deal with annoying microphonic tube problems by simply using a little common sense. Avoid turning the GAIN all the way up where possible!

If you must crank the GAIN for a specific part or at very low volumes, back down the TREBLE and PRESENCE Controls. Your Recto was designed to provide amazing gain and tone at less-than-extreme settings, removing the need for you to crank everything all the way up. If you are not able to achieve the sound you want at sensible settings on any or all of the controls, your problem may lie elsewhere in the signal chain, i.e., pickups, cabinetry, processing, etc. Keep in mind you can always call on one of our Product Specialists and seek some advice should you find yourself struggling to get the sound you want.

GAIN - In conjunction with the Tone Controls – Basically, a simple rule applies: as the Gain is increased, the Tone control string has less and less effect on the signal, until at 5:00, the signal is so saturated that you are getting mostly Gain and very little Tone. Again, this is the reason we suggest using the GAIN Control in its middle region. Here, the Tone control string is very active and provides maximum shaping power, allowing you to dial virtually any sound you desire.

Not only do the opposing ends of the gain spectrum sound different, but it is also important to remember that as the signal becomes more saturated and overdrive increases, the dynamic response changes and the attack

can begin to feel “slower” and less immediate. That’s not always a bad thing because the styles played with overdrive lend themselves naturally to the sound, shape, and feel produced by the added gain, but rather just in comparison to clean sounds, where the attack is more immediate and the dynamic content broader.

Some of the best sounds fall in the Tone Zone, as we call it, somewhere closer to the middle zone of the GAIN control’s range, say 11:00 to 2:00, depending on the Mode and application. The lower the setting, the brighter and more stripped of low end the sound will be; the higher the setting, the warmer, thicker, and fuller the sound will become.

Outside this range, the differences will be more extreme, and at some point, there will be either weak sound when set too low or a compromised attack with less dynamics when set too high. For clean work in the CLEAN setting of Channel 1, you may want the GAIN somewhere between 11:00 and 1:00, or possibly even 2:00 depending on pickup strength and your attack velocity/touch. For higher gain overdrive work in the VINTAGE or MODERN modes, you will likely find great sounds upwards of 2:00 and hopefully below 4:00, in order to retain the optimum attack and still have ample sustain for soloing.

TREBLE

Next to the GAIN control, the TREBLE is the most critical control on the amplifier, or at least certainly among the preamp’s Tone Controls. It feeds the Tone control string, and therefore its setting can determine how powerfully the MID and BASS work. Like GAIN, there are three zones in the TREBLE’s range: low, middle, and high. These are as simple to understand/translate as warm, cut, and bright, with the bright (highest) zone having a pseudonym/nickname, which is “dangerous,” at least when it comes to “musically balanced” sounds.

The lowest range is where the round, warm sounds will be found. The most usable part of this range is between 9:30 and 11:30, with the portion below 9:30 having few uses apart from purposefully dark sounds, perhaps for jazz or a certain effect, and even there, 10:30 – 11:30 being the most useful in that musical genre.

The middle range is where some of the best performance and sounds are found for a wide range of instruments and styles, 11:00 – 1:00 being by far the most frequented for most players. In this middle range, the balance between all the Tone controls is at its best, and plenty of brightness, cut, and openness is available for almost any style and/or instrument.

From 1:15 through 3:30 on the TREBLE will, for most players, be used in very specific applications that call for maximum attack and cut with an instrument that is shy on top end, or for a gained-up chording sound in a crowded mix. When using settings in this zone, you may also need to increase the BASS and MID to fill in the gaps, as the TREBLE set up there overpowers the other two Tone controls.

The highest zone of the TREBLE can be used for the high gain sounds as well as to add attack and cut in cleaner sounds, but keep in mind that, like when the PRESENCE is set high, it can also lend an unwanted buzzy or fizzle-y quality to the sound if you are not careful, especially on single notes if not balanced well with the other Tone controls.

Lastly, avoiding very high TREBLE settings can help reduce hiss and excess noise in your amplifier, especially in the VINTAGE and MODERN high gain sounds. Avoiding that region can also reduce the likelihood of tubes with microphonic tendencies to begin squealing or whistling, especially at high GAIN settings combined with high TREBLE settings. We pay special attention to this in the final play-testing as your amplifier was built, but no one can predict what a tube will do over time with continual use, temperature fluctuations, and the bumps, jiggles, and bounces incurred in traveling.

MID

The MID control is responsible for the blend of a wide band of midrange frequencies in the mix, adding or taking away punch and authority. Though its effect is not quite as dramatic as that of the TREBLE control, it plays an integral part in achieving the sounds you imagine and will craft. It also can dictate much about the feel of resiliency and recessive-ness versus tension and forwardness. This is because the band of frequencies

the MID carries contains a fair portion of the higher midrange attack characteristics and frequencies. Those frequencies below the higher Treble elements but above the lower, critical “punch region.”

At the lower end of its range, the MID scoops these midrange “attack elements” and creates a resilient, easy-to-play feel that is forgiving and broad-sounding, allowing the top end and low end to be the dominant parts of the EQ curve, creating the impression of a wider landscape.

The middle and upper ranges of the MID control bring in the punch, attack, and forwardness that mid-dominant sounds are known for. Depending on the instrument, musical style, and/or technique level, some may find this degree of punch and forwardness stiff feeling and unforgiving to play, so this is something you will need to determine for yourself through experimentation.

Clean sounds in the CLEAN Mode of the VINTAGE/ORANGE Channel sometimes sound wider and feel easier to play with lower settings of the MID, say 9:00 – 11:30, depending on the instrument. Again, this region of the MID allows more low-end breathiness and air to support the sound and more top-end shimmer to come through and open it up, the overall result being a more three-dimensional character.

Gain sounds – depending on the style of music and application (Rhythm or Soloing) – can call for either a lower setting with scooped mids or a little more midrange dialed in to make the sound more authoritative or aggressive and to focus the attack.

For clipped/overdriven Rhythm work, the MID can color the sound and change the feel substantially. The lower range will let the gain smear the notes more evenly and cohesively, while a higher setting adds gain but also changes the texture and attack, causing some elements to stand out more than others.

In the MODERN/RED Channel, you can introduce more midrange, and the added top end present in the overall character of the Channel’s voicing will keep the top end more balanced. Then, all you have to do is fill in the bottom end for a HUGE and aggressive sound.

By the same token, you may find yourself not using the same MID setting that works in VINTAGE/ORANGE; you may optimize and configure the amp for maximum aggression in the RED Channel and leave ORANGE to be its sweeter, more liquid, layered self for single note soloing.

BASS

The BASS is one of the easiest controls to understand and operate here in the 90s Dual Rectifier, as it is largely independent and obvious in terms of controlling a frequency range within the preamp. Being a low-frequency control, and knowing low frequencies come across as not just lower but also “slower,” it doesn’t have the potential for unpleasantness at higher settings that the TREBLE control could at times present, so no worries there. There IS interaction to be aware of, and we will get to that, but for the most part, it can be used at your discretion to fill in and round out your sound, especially in the sounds that are not highly saturated with gain/overdrive.

Probably the main interaction to consider, and perhaps even caution about, is the interaction between the GAIN control and the BASS. Due to the Recto’s architecture, the scenario is a bit more lenient than say, in our Mark Series amplifiers, and this is due to the placement of the Tone Controls in the signal path.

Here in the 90s Dual Rectifier, the Tone Controls are located farther downstream in the circuit’s path. Therefore, there is not as much potential for amplifying and reamplifying low-end that’s dialed up early in the preamp. This means you can dial up the low end in greater amounts without the worry of bloating out the signal and overwhelming subsequent stages in the preamp. The low end you dial up here is being applied at the “end of the line,” and to a signal that has already had its gain structure “built out” and buffed, so there is less danger of further amplifying a signal that is too fat with low end.

That said, there are physical realities in cabinetry, rooms, and musical contexts, so you still want to dial BASS tastefully and with discernment. Some Cabinets can handle more low-end than others; Closed Back or Ported

Cabs are far more resilient in terms of low-end than Open Back Cabinets. Some rooms/venues are forgiving of low-end, and some are not and require greater degrees of discretion. Low-end build-up in a room can be really challenging, turning every mic into an antenna, so the unspoken Rule of Tone dictates, “as much as you need and no more” with the BASS, just as it does globally with GAIN and TREBLE.

Some music calls for ominous low end while other styles dictate tighter, faster-tracking low end to accentuate the start and stop times of the notes. Ultimately, it is wise and appropriate to apply the BASS in context, and this will help keep you in great Tone. Every style, player, and musical environment will have its own parameters and perhaps challenges, and learning your amplifier’s character and the interaction between the GAIN and Tone controls will allow you to become an ace navigator of anything that comes your way musically.

PRESENCE

The PRESENCE is a Tone control of sorts located in the later part of the signal chain in the power section. It adjusts the mix of a predetermined (high) frequency relating to the negative feedback circuit in the power amp. It is a very powerful control, and its setting can give the impression of opening the sound up and adding brightness and attack, or clamping the sound down, compressing and darkening it. These characteristics, in turn, affect how you perceive dynamic content, as brighter sounds appear faster while warmer sounds feel slower and more relaxed in terms of their perceived speed.

This addition or removal of top end with the PRESENCE control can seem to move the sound forward and back (near or far) in the musical landscape (mix) and help define whether the sound feels either “tight-tracking” or “behind the beat.”

Clean sounds tend to handle higher PRESENCE settings well to a point, then things can become too forward. Overdrive sounds usually call for lower to medium PRESENCE settings as the added harmonic content can start to sound detached and buzzy with too much of this top-end accentuation.

Crunch Rhythm and Heavy chording sounds can tolerate added cut and sizzle from the medium to the higher range of the PRESENCE, but how much usually depends on the track or ensemble mix it is sitting in, as well as your touch, your guitar, its pickups, and the room or mix.

As mentioned before, along with the PRESENCE, the top end can be swapped around by utilizing the differing frequencies found in the TREBLE and even the upper range of the MID control that carries some high mid/low treble region cut. Between these three regions and flavors of high frequencies, you should be able to sculpt just the right type and amount of top end you need.

NOTE: In the two “Cloning” positions of the CHANNEL STYLE SELECT switch, the PRESENCE will respond differently due to the difference in negative feedback between the two circuits.

In the “ORG. TO MODERN” mode, the PRESENCE in the top (normally ORANGE) Channel will have reduced effectiveness, because the negative feedback is removed in this re-configuration to make the power section as aggressive, “fast,” and forward as possible, leaving little for the PRESENCE (which operates on a select frequency of the negative feedback) to work with/on.

In the “RED TO VINTAGE” mode, the PRESENCE in the bottom (normally RED) Channel will still operate minimally and upon the same frequency, AND... the top ORANGE Channel’s (normally configured) PRESENCE will also work – even though you are technically not “in” that Channel. This provides you with the power section “feedback type” PRESENCE you always have in the (normally configured) top ORANGE/VINTAGE Channel when the CHANNEL STYLE SELECT switch is in its “normal” center position.

This is a little complex at first thought, and it was complicated to originally figure out all those years ago when the Dual Rectifiers were in development, but the simplest way to think about it is this:

When you’re using the “Cloning” feature and have the bottom Channel set to “RED TO VINTAGE,” you have a bonus in the form of TWO PRESENCE Controls to shape with ... the one in the lower Channel you are using/

playing through and another stacked right above it which operates in a different part of the circuit – in the power section – like it normally does in the upper ORANGE/VINTAGE Channel.

This can be nice if you are someone who appreciates the VINTAGE sound most and needs two footswitchable versions/Channels of that sound (and performance throughout) to accomplish your musical aspirations. The added flexibility allows you to fine-tune the top end and feel of the alternate version of the Channel even more specifically for some applications. This can be especially cool for soloing applications in the studio, where you might want to further define the top-end harmonics for certain lead work.

MASTER

This control is located at the end of the preamp and it serves three purposes. One, it allows you to set the volume of the Channel relative to the gain level chosen by the GAIN control's setting. Two, it allows you to balance the volume level of the Channel in relation to the adjacent Channel once the desired gain level and (relatively close) volume level are reached, so that it serves favorable footswitch-ability between the Channels. Three, its setting determines roughly what the SEND Level strength will be at the Effects Loop's SEND output.

You might ask then; "If the Channel Masters act as SEND LEVEL controls, why is there a separate/additional SEND LEVEL in the Effects Loop?" The answer is that the SEND LEVEL is provided to broaden the range of control for the SEND's signal strength to accommodate a wider range of optimal processor input levels once your playing level is established. It also helps with compensation for SEND levels outside the nominal/normal range that might be dictated by your stage or personal volume requirements for the Channels. If they are very high or very low, the SEND will see a signal that is too strong or too weak. This scenario can be more easily navigated with the additional adjustability provided by the SEND LEVEL control.

That covered, the MASTER allows you to set virtually any combination of gain level – using the GAIN control – and playing volume level using the MASTER. For Cleaner sounds in the VINTAGE/ORANGE Channel, you can reduce the GAIN for maximum input headroom in the preamp and crank the output of the power section for maximum output level. For high gain overdrive sounds in either Channel, you can do the opposite and crank the GAIN for the heavy overdrive in the preamp and reduce the output of the power amp for more controllability and volume/Channel balancing.

In terms of interaction with other controls, the two most sensitive and related are the GAIN and the BASS. GAIN mostly in terms of extreme settings of both creating the possibility of oscillations or microphonic preamp tube issues (high-pitched or low-pitched resonances, squealing, motorboating, or ringing) at very high settings. BASS, mostly in relation to extreme settings of GAIN and MASTER in combination with higher BASS settings, has the potential to overwhelm your sound with low frequencies and, at high volumes, potentially your speakers as well. When it comes to these controls, try to balance the two, or three, such that you don't approach extremes in any more than one at a time, and you should be fine.

LED – CLEAN

This Green LED is illuminated when you have selected CLEAN with the VINTAGE/ORANGE Channel's ORANGE GAIN SELECT switch. When you have selected CLEAN, the top ORANGE Channel is configured for traditional gain preamp levels and optimized for clean playing.

LED – LOOP

This Yellow LED is illuminated when you have engaged or assigned the Effects Loop via the Rear Panel LOOP SELECT rotary switch or triggered it remotely via the port in the Rear Panel EXT. SW. (EXTERNAL SWITCH) section. To trigger the Loop remotely with standard "Tip to Ground" latching (not Momentary) logic, you will first need to set/assign the Effects Loop, via the Rear Panel LOOP SELECT rotary, to the (far Right) EXT SW. position.

NOTE: The CHANNEL SELECT Switch on the Rear Panel's Far Left must also be set to "ORANGE" Channel (switch up) to recognize switching logic at the EXT. SW. jack/port.

LOOP ACTIVE MASTER

The Effects Loop of your amplifier is probably one of the most comprehensive Loops in any amplifier. It is a Series Loop, meaning it is wired in Series with the dry signal and is comprised of five elements, four on the Rear Panel and one on the Front Panel. Together, they provide virtually seamless interfacing of processors of almost any style while preserving the integrity of this high-tuned gain machine. The LOOP ACTIVE MASTER is the Effects Loop's RETURN stage level control.

Once the Effects Loop has been engaged for one or both of the Channels via the LOOP ASSIGN rotary switch and signal is sent through the Loop with your mix level(s) set on your processor(s) and your Channels balanced in terms of level with the Channel MASTER controls, you can raise and lower the volume of the entire amplifier via this one LOOP ACTIVE MASTER final output control.

NOTE: Selecting BYPASS on the Rear Panel LOOP SELECT rotary will defeat not only the EFFECTS LOOP but also the Front Panel LOOP ACTIVE MASTER Control, as it is part of the Effects Loop's RETURN circuitry. This tube stage and all associated circuitry are omitted when you select LOOP BYPASS. With the EFFECTS LOOP in BYPASS mode, the individual Channel MASTER Controls are the final/individual output level controls.

PILOT LIGHT

A jeweled lens covers the Pilot Light, which indicates the amplifier is powered up and on. The Pilot Light is illuminated any time the 3-position POWER switch is flipped to either of the ON positions ("BOLD"/up or "SPONGY"/down). The Pilot Light – and the amplifier – will remain off in the center "0" position.

STANDBY

The STANDBY provides a warm-up/idle state for the tubes in your amplifier. It should ALWAYS be used at power up, even if the amp's chassis is warm to the touch from recent use. This is because tubes cool far more quickly than other components like the chassis and transformers, and even when they are warm, it is far easier on their filaments to have 30 seconds of warm-up/prep time before being hit with the high voltage.

The STANDBY also doubles as a mute feature for set-up before and breaks during performance. Use the STANDBY any time you are pausing from playing and want to keep your amplifier in a warm and ready state. If you're going to take a break for a couple of hours, it's probably best to power down to save electricity, just be sure to use the Cold Start Procedure (under the POWER instructions below) when you return and want to power back up and use the amplifier again.

NOTE: A little preemptive troubleshooting instruction here that you may never need, but is good to know anyway as a tube amp owner/user:

Should you ever flip the STANDBY to ON and hear a loud hum or loud static, or should you smell something hot/burning, quickly flip the STANDBY to OFF. What you could potentially be hearing (or smelling) may be a power tube arcing or shorting. While this is rare, it can happen if a power tube were to become faulty. In the event it ever does occur, flipping the amplifier to STANDBY stops the incident right away. On occasion, it will correct the problem, but often it can reoccur. You can troubleshoot the problem using the method below:

While looking at the Rear of the amplifier and watching the power tubes (you may need to move the Tube Cage by unhooking the nylon clips and moving it out of the way or removing it altogether), flip the STANDBY to ON.

If a power tube(s) is arcing or shorting, you will likely see it flashing brightly rather quickly or perhaps glowing red in the tube's center metal parts more than the rest of the set. This can be accompanied by a loud hum or static/arcing sound. Sometimes an arcing or shorting tube can pull its paired counterpart out of bias and cause it to "run away" as well. Regardless, flip the STANDBY to OFF as quickly as you can. This will stop the incident from escalating.

Get an "OV-Glove" or similar method of hand protection (leather gloves, a rag, etc.) to grab the hot tube with! Do NOT use your bare skin as the tubes will be very HOT!

Push down the spring steel Tube Clamp(s) so they are not gripping the tube Base and gently rock the faulty tube back and forth slightly while pulling it up and out of its socket. Notice the orientation of the tube guide (raised bump) on the plastic piece in the center of the tube's base.

Gently and slowly and making sure the Tube Guide is aligned with the slot in the socket, install a new tube of the same type and color rating (preferably matched MESA Tubes) as the one(s) removed, if possible. Again, make sure to line up the plastic guide bump with the slot in the tube socket's center hole. Make sure the tube is seated completely in the tube socket and that the tube filaments light up. If they are not lit up and glowing orange, check the tube's orientation and that it is seated firmly and completely into the socket. If the plastic center guide is intact and not broken, you will only be able to install the tube one way. Keep re-orienting the tube one turn at a time until the guide slides in the channel in the socket easily. Do NOT force the tube, as you may break the plastic center guide, or worse, bend the tube pins or their sleeves inside the socket to the point tube pins can't accept the tube pins. Be patient and be gentle and you will complete this step successfully.

Flip the POWER switch to ON and wait at least 30 seconds.

While watching the rear of the amplifier – and specifically the power tubes again – flip the STANDBY switch to ON.

If you do not see any unusual flashes or brightly glowing (red hot) metal in the center of any of the tubes, hear no loud hum, or see any “fireworks,” you have remedied the issues and are ready to enjoy your amplifier again.

If you see a flash or the center of the tube is glowing bright red in the center of the metal inside the glass, repeat the steps in this troubleshooting section again using another/different (hopefully known good) power tube(s), and hopefully of the same color rating.

POWER

Your amplifier incorporates a 3-position POWER switch that offers two different power modes for a different character, feel, and voicing. This is akin to having a built-in “Variac” on board to achieve the sagging power vibe (sound and feel) associated with the “Brown Sound” (Brown-out Line conditions) on command with the flick of a switch.

BOLD, the more “normal” of the two, delivers the full 117 (120) volts of AC Line voltage (US Domestic version) to the amplifier for maximum headroom and an authoritative voice full of punch and accuracy, especially in the lower frequencies, but really throughout the frequency spectrum.

SPONGY performs much like a Variac set to achieve a lower incoming AC Line voltage and offers a softer, saggier feeling response along with a more scooped midrange character and emphasized upper harmonics.

It is important to note that these two options change the voltage across the entire amplifier, both in the preamp and power amp, which, in turn, changes the response of the entire amplifier. The preamp, as well as the power amp, will be operating on lower voltages across the board in **SPONGY** and this shapes the sound quite differently than when the full 117 volts (**BOLD**) is feeding the circuit.

Though not a perfect description of the effects of these choices, **BOLD** generally produces a more punchy, fast, and authoritative attack characteristic, more boldness throughout the midrange, and a focused and slightly lower frequency top-end character. **SPONGY** delivers the opposite with more air and breath in the lows and highs, a more scooped midrange, and some high harmonic enhancement, along with a softening effect and the impression of layering.

In application, **BOLD** delivers the headroom and tight tracking authority to ensure low notes will remain focused and track well through rhythmic and/or dynamic passages. This is especially true when higher gain levels are in play. Crunch Rhythm styles that demand percussive, tight grooving with high gain benefit from the added punch and control **BOLD** delivers.

It is also the choice for Clean playing in the Orange/Vintage Mode, where headroom is key. The preamp is fed with the normal, higher voltage and, therefore, is able to deliver the full dynamic range with speed and accuracy. For single-note soloing, BOLD delivers a more voice-like response, where the midrange content is full, rich, and balanced, and the notes are dynamic and present in a mix.

SPONGY performs well when you want a more legato, liquid feel and a sound with more scoop in the midrange, which can have a widening effect as the sound seems to come from more than just the immediate area of the speaker cabinet. Because of this, SPONGY can seem more “3-D,” so for textural parts it can be a good choice. Lowering the voltage in the preamp scoops the midrange and accentuates upper harmonics and this results in a better “smear” overall, which can be helpful with lower gain work.

SPONGY works well for big sustaining overdriven Chord beds or Lead work where you want elasticity and an “ease” or lack of resistance on the strings for fluid lines. SPONGY can also provide help when looking for clipped “Edge of Clean” sounds. It will lower headroom, allowing for more power “break up,” and smear the attack while softening the high harmonic elements which can sound relaxed, warm, and soulful.

Regardless of how you apply the options on the POWER switch, the ability to tune your incoming Line Voltage to the characteristics that best enhance your stylistic needs adds a wonderful element to the 90s Dual Rectifier. That the rest of the industry has adopted and paid tribute to the Recto in this area points to its impact on popular music and guitar amplification. While our patent on this simple but effective feature has long since run its course, perhaps you can smile and know that you have an original and put this iconic power tuning to good use in your music.

Now that we’ve reviewed the Controls and features located on the Front Panel, let’s jump to the Rear Panel and go over the controls, connections, and interfacing features located there.

REAR PANEL

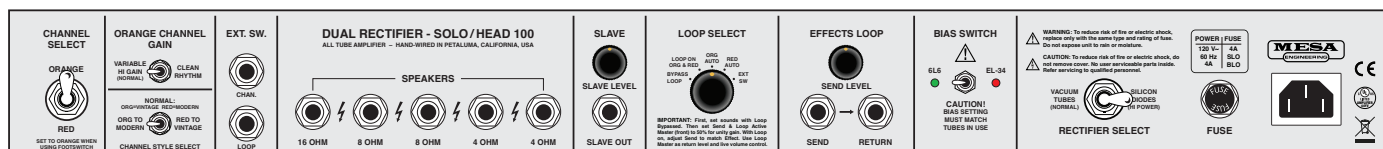

CHANNEL SELECT

This 2-position toggle switch selects the Channels when the Footswitch is not connected or in use. As labeled, the ORANGE Channel is engaged when the switch is in the upper position, the RED Channel is engaged when the switch is in the lower position. As also notated on the Panel, the switch must be in the upper ORANGE (Channel) position for the Footswitch (when connected) to operate and allow remote switching of the Channels with the 3 MESA Footswitch. In the lower RED position (switch down) the Footswitch will have no effect on Channel Selection.

NOTE: To control/select the Channels with a remote switching system (using standard Tip to Ground latching-type logic) via the Rear Panel EXT. SW. jack, the CHANNEL SELECT switch must be set to the ORANGE (Channel) position (switch up).

ORANGE CHANNEL GAIN

This horizontal toggle switch selects the gain of the ORANGE Channel (only). It offers two radically different gain structures to choose from.

VARIABLE HI GAIN

Set to the Left – “VARIABLE HI GAIN” – the top ORANGE Channel will be configured in its higher gain VINTAGE Mode. This setting delivers the iconic Dual Rectifier VINTAGE high gain and provides thick, rich, high gain (overdrive) with a forgiving, legato feel. This is a good choice for anything from purring overdrive in the GAIN control’s lower range, through giant Crunch for Rhythm playing in its middle range, all the way

to “fire hose” high gain with complex harmonic layering for soloing in its higher range. Regardless of where you set the GAIN control, ORANGE/VINTAGE delivers one of the most expressive and sought-after modern gain sounds there is and one you’ve likely heard many times on the radio in countless hit songs from the 90s and 2000s.

CLEAN RHYTHM

Set to the Right – “CLEAN RHYTHM” – the ORANGE Channel will be reconfigured for traditional gain clean performance with a radically reduced gain structure and different EQ shaping that is optimized for greater headroom and dynamic clean rhythm playing.

CHANNEL STYLE SELECT

This 3-position horizontal switch allows for “Channel Cloning,” meaning that you can configure the amplifier such that instead of having two different Channels, you can have (the same) two of either Channel, should it better serve your musical needs.

Set in the Center position – “NORMAL” – the Channels will be configured normally where they are different and deliver the iconic (top) ORANGE/VINTAGE Channel and the (bottom) RED/MODERN Channel.

Set in the Left position – “ORANGE TO MODERN” – the top ORANGE Channel will be reconfigured to deliver the bottom RED/MODERN Channel’s sound/performance, giving you two RED Channels.

Set in the Right position – “RED TO VINTAGE” – the bottom RED Channel will be reconfigured to deliver the sound/performance of the ORANGE/VINTAGE Channel set to “VARIABLE HIGH GAIN” (on the ORANGE CHANNEL GAIN switch), giving you two ORANGE/VINTAGE Channels.

The one caveat here is that the PRESENCE controls cannot be switched identically due to the location of their two different circuits in the two different Channels/Modes as well as their pot values.

In the two “Channel Cloning” positions of the CHANNEL STYLE SELECT switch, the PRESENCE will respond differently due to the difference in negative feedback between the two circuits.

(The following is mostly repeated from the PRESENCE section under FRONT PANEL for added clarity)

In the “ORG. TO MODERN” mode, the PRESENCE in the top (normally ORANGE) Channel will have reduced effectiveness, because the negative feedback is removed in this re-configuration to make the power section as aggressive, “fast,” and forward as possible, leaving little for the PRESENCE (which operates on a select frequency of the negative feedback that has been removed to give you the RED Channel’s performance) to work with/on.

In the “RED TO VINTAGE” mode the PRESENCE in the bottom (normally RED) Channel will still operate minimally and upon the same frequency, AND... the top ORANGE Channel’s (normally configured) PRESENCE will also work – even though you are technically not “in” that Channel. This provides you with the power section “feedback type” PRESENCE you always have in the top ORANGE/VINTAGE Channel when the CHANNEL STYLE SELECT switch is in its Center “NORMAL” position.

This is a little complex at first thought, and it was complicated to originally figure out all those years ago when the Dual Rectifiers were in development, but the simplest way to think about it is this:

When using the “Channel Cloning” feature and you have the bottom RED Channel set to “RED TO VINTAGE,” you have a bonus in the form of TWO PRESENCE Controls to shape with ... the one in the lower Channel you are using/playing through, and another stacked right above it which operates in a different part of the circuit – in the power section – like it normally does in the upper ORANGE/VINTAGE Channel when the CHANNEL STYLE SELECT switch is in the Center NORMAL position. Keep in mind when you go back to the upper “normal” ORANGE Channel, the PRESENCE will still be set where you set it for the lower row’s “Cloned” ORANGE sound. Most times this is not an issue, and even if it becomes one, you can always just flip your thinking (and application of the two versions of the ORANGE Channel) to accomplish what you need.

This can be nice if you are one who appreciates the VINTAGE sound most and need two footswitchable versions/Channels of that sound (and performance throughout) to accomplish your musical aspirations. The added flexibility allows you to fine-tune the top end and feel of the alternate version of the Channel (on the bottom row of controls) even more specifically for some applications. This can be especially cool for soloing applications in the studio, where you might want to further define the top-end harmonics for certain lead work.

EXT. SW. (External Switch)

These stacked ¼” jacks are provided for allowing external control of the Channels and Effects Loop in a larger system controlled by MIDI or some other proprietary switching format where the amplifier’s Footswitch is not practical or in use.

The top/upper jack is for triggering the Channels, the bottom jack is for triggering the Effects Loop. The bottom jack will only engage the Effects Loop when the Rear Panel “LOOP SELECT” Rotary selector is in the “EXT. SW.” position (far Right/clockwise to stop).

NOTE: The EXT. SW. jack and the Front Panel FOOTSWITCH jack are wired in tandem. Therefore, the CHANNEL SELECT switch on the far left of the Rear panel must be set to “ORANGE” for the EXT. SW. jack to operate and accept switching logic from an external switching source.

NOTE: The EXT. SW. jack accepts standard “tip to ground” type switching logic (not “momentary” switching logic). Most external switching devices and master controllers support this type of logic, but it is wise to confirm that any controller you are interested in supports this type of logic before you purchase it if you plan on controlling the Channels and Effects Loop of your 90s Dual Rectifier.

SPEAKERS

These 5 jacks provide the SPEAKER Outputs for your amplifier, and between them, nearly any cabinet configuration can be accommodated. The most common would be the stylistically appropriate MESA Rectifier 4x12 or 2x12 cabinets. Both of these great-sounding cabs are wired for 8 Ohms, the 4x12 through Series/Parallel wiring of four 8 Ohm speakers, and the 2x12 through Parallel wiring of two 16 Ohm speakers. Most MESA cabinets are wired for 8 Ohms Total Load so that you can add an additional (8 Ohm) “Extension” Cabinet and run the two together using the two 4 Ohm SPEAKER Outputs provided.

It is also possible to run one 4 Ohm Cabinet using one of the 4 Ohm SPEAKER Outputs, one 16 Ohm Cabinet using one of the 8 Ohm SPEAKER Outputs, and two 16 Ohm Cabinets utilizing both of the 8 Ohm SPEAKER Outputs. These cabinet configurations constitute the most popular and safest cabinet/impedance matches. Remember that **2 Ohm Loads (i.e. two 4 Ohm Cabinets) ARE NOT RECOMMENDED** and can harm your amplifier.

NOTE: Damage to your amplifier caused by improper impedance matching will not be covered under the Warranty.

SLAVE OUT

The SLAVE Output and LEVEL control are provided for interfacing with an external Processor/Effects Rack, additional power (stereo power amp or additional Head) and Cabs for Stereo imaging or headroom in large stage applications, or an external IR Reader for ‘silent” Direct Recording applications.

The signal present here is a “non-compensated” signal with no speaker compensation or voicing of any kind. It is derived from the SPEAKER Outputs, then padded down to produce an appropriate signal level. The signal includes the entire amplifier – preamp and power amp – but NOT the sound and inherent shaping that speakers impart.

The SLAVE Output is NOT a “Direct Out” or “Recording Out” intended for interfacing directly with a Console or digital Recording Interface. Trying to use it as such will immediately reveal this fact with its bright, forward EQ and unpleasant artifacts, which are seldom, if ever, heard when using cabinetry and playing live. The signal here lacks the complex top-end roll-off and shaping that occurs with a speaker’s characteristics in the live reproduction of the sound.

This is not a problem as the SLAVE signal is intended to capture the sound of the amplifier and pass it on to other amplifiers (or effects processors, then amplifiers), which are likely to have speakers – or simulations/captures of speakers – in their signal chain.

NOTE: Always “zero-out” the SLAVE LEVEL control before connecting to your (any) destination (processor/amplifier/IR Reader) to avoid accidental noise, speaker, and/or hearing damage from accidental notes/sounds from the instrument or interconnects when setting up your amplifier and interfacing it with other devices.

LOOP SELECT

This 5-position Rotary control selects the assignment and/or status of the EFFECTS LOOP in the signal path. The Positions for Loop assignment/status are as follows:

- **BYPASS: EFFECTS LOOP** is Bypassed and the LOOP ACTIVE MASTER on the Front Panel is inoperative. Use the Channel MASTER controls to adjust the overall volume of the Channels.
- **LOOP ON ORG & RED: EFFECTS LOOP** – including the Front Panel LOOP ACTIVE MASTER – is engaged and in the signal path for both ORANGE and RED Channels. This will be the default setting for many players as it offers the most flexibility in a live performance. Every time either Channel is selected, the Loop is active.
- **ORG. AUTO: EFFECTS LOOP** is auto-selected in the ORANGE Channel ONLY. The RED Channel will be in Loop BYPASS mode. The Front panel Loop Active Master will still work and provide global adjustment of the output volume.
- **RED AUTO: EFFECTS LOOP** is auto-selected for the RED Channel ONLY. The ORANGE Channel will be in Loop BYPASS mode. The Front panel Loop Active Master will still work and provide global adjustment of the output volume.
- **EXT. SW.: EFFECTS LOOP** will remain in BYPASS mode until it is switched on via the EXT. SW. jacks located on the left side of the Rear Panel. NOTE: The CHANNEL SELECT switch on the far left of the Rear Panel must (also) be set to “ORANGE” (switch up) for the EXT. SW. jacks to allow triggering of the Effects Loop (and Channels) remotely via an external switching device.

EFFECTS LOOP

The Effects Loop in your amplifier is likely one of the more comprehensive Loops in any amplifier. It is wired in Series with the dry signal and is comprised of five elements: four on the Rear Panel and one on the Front Panel. Together, they provide virtually seamless interfacing of processors of almost any style while preserving the integrity of this highly tuned gain machine.

The LOOP ACTIVE MASTER is the Effects Loop’s RETURN stage level control. Once the Effects Loop has been engaged for one or both of the Channels via the “LOOP SELECT” rotary switch and the signal is sent through the Loop with your mix level set on your processor(s) and your Channels balanced in terms of level, you can raise and lower the volume of the entire amplifier via this one LOOP ACTIVE MASTER output control.

NOTE: Selecting BYPASS on the LOOP ASSIGN rotary will defeat the Front Panel LOOP ACTIVE MASTER Control, as it is part of the Effects Loop’s RETURN circuitry. This tube stage and associated circuitry are omitted when you select LOOP BYPASS. With the EFFECTS LOOP in BYPASS mode, the individual Channel MASTER Controls become the final output level controls.

The elements of the EFFECTS LOOP are as follows:

1. A **LOOP SELECT** rotary control on the Rear Panel that provides control over when the Loop will be active and its LOOP ACTIVE status, trigger it remotely or completely remove it from the signal path altogether.
2. A **SEND LEVEL** Control on the rear Panel that allows the matching of levels between the output (SEND) of your Recto and your processor’s input.

3. A **SEND** jack that captures the preamp signal and pads it down to accommodate the outboard signal processor's input stages.
4. A **RETURN** jack that accepts the signal from a processor's output and boosts the level back up to unity gain (or beyond, depending on your processor's output settings) to be mixed back into the original signal.
5. A **LOOP ACTIVE MASTER** Control (Front Panel) that is the Effects Loop's RETURN stage level control, which also doubles as an overall output level control for the amplifier. This scheme allows the Channel levels to be matched to each other and/or fine-tuned for a sound and an effects level. Once this is achieved, the level of the whole amplifier can be raised or lowered with one control.

NOTE: "LOOP BYPASS" defeats the Front Panel LOOP ACTIVE MASTER Control as it is part of the Effects Loop's RETURN circuitry. This tube stage and associated circuitry are omitted when you select LOOP BYPASS on the LOOP SELECT rotary. With the EFFECTS LOOP in BYPASS mode, the individual Channel MASTER Controls become the final output level controls.

Try this method of interfacing outboard processors for the best results:

1. Connect your processor's Input to the SEND jack.
2. Connect the output of your processor to the RETURN jack.

NOTE: The shortest possible length of high-quality shielded cable should be used to connect the processor to the Loop jacks. Longer lengths and/or poor cable quality can roll off top end or reduce punch and attack characteristics.

3. Set the channels for your desired applications and sounds.

NOTE: Keep in mind that cleaner sounds, though they appear to be the same volume as saturated sounds, send a more dynamic signal to your processor and, therefore, will probably register as a hotter signal on the processor's input indicator. This is not a problem, but it will be of interest when setting up the sounds and channels. Set the channel MASTERS so that each sound is the right volume to balance with the other Channel and don't worry too much about the processor's input indicator unless clipping occurs. If that happens, you can reduce the SEND LEVEL until clipping is no longer occurring.

4. Select the "LOOP ON ORG & RED" (#2) position on the LOOP SELECT rotary control.
5. Fine-tune the send level with the SEND level control so that the processor's input stage is not clipping in either channel and sending adequate level. The NORMAL region marked on the sweep between (11:00 and 2:00) should provide a good match for most processors/effects. Don't worry if the level seems like it dropped ... you still have the return stage control (in the LOOP ACTIVE MASTER on the Front Panel).
6. Set the desired mix of dry (unprocessed) to wet (processed) signal with the processor's mix control.
7. Bring the amplifier up to the desired playing volume with the Front Panel LOOP ACTIVE MASTER Control.

NOTE: The FX LOOP RETURN jack can be used as an input to the power amp of your Recto, making it possible to use it for amplifying signals derived from other preamps or effects in a stereo setup. When connecting to this jack as a power amp input only, the LOOP ACTIVE MASTER Control will be active. For the most balanced response in power, use the ORANGE/VINTAGE mode. This will configure the power section with the proper amount of negative feedback, which will, in turn, make the Recto's RETURN stage (power amp) respond with a more traditional, easy-to-manage input sensitivity.

The PRESENCE Control will work in this scenario, and you can use it to tailor the top-end harmonics to your needs. The MODERN mode can be selected to achieve a substantially higher input sensitivity, but you will have to be careful as this will make the LOOP ACTIVE MASTER Control far more powerful and

the amp will be sensitive and most likely LOUD, so use caution.

RECTIFIER SELECT

Rectifiers take high voltage AC (Alternating Current) coming from the power transformer and convert it into the DC (Direct Current) that the tubes need/can use. Two types of rectifiers exist: the original tube rectifiers used since guitar amps first appeared in the 40s and the more modern silicon diode “solid state” rectifiers that can deliver more regulated, more efficient current that won’t sag as demand increases. They each have their sonic and physical characteristics and your 90s Dual Rectifier features the ability to switch between these two different types of rectifiers, hence its name. This originally-patented feature showcases the different characters in sound and different sag characteristics, speeds, and trackability in regard to feel and allows you to optimize the rectification style for what suits your musical applications best.

Clean sounds and percussive gained-up Rhythm parts often call for tighter tracking, more articulation and definition in the low end, more headroom, and bolder, faster attack characteristics. All these traits point to being a perfect match for solid state rectification, where the supply of current is steadfast, has less sag, and a faster recovery time to keep dynamic punctuation at its best.

Conversely, solo sounds, and especially single notes with overdrive applied, call for the opposite. They want enough sag to breathe and bounce a little, a more forgiving feel on the strings that is the opposite of stiff and forward, and a more breathing, three-dimensional character that has girth and fatness. These traits point at tube rectification, which delivers its current in a less linear, more musically oriented fashion that feels more engaging and has some sag and bloom.

SOLID STATE: This mode calls up the silicon diode rectifiers, which offer a tighter, faster attack with added brightness, more midrange punch, more headroom, and a well-defined attack. Again, this would be the preferred position for loud clean playing, tight rhythmic playing with a high front-end GAIN setting, or anytime you need a bold, authoritative attack and wide dynamic accuracy.

VACUUM TUBE: This setting takes a power section walk down memory lane, paying tribute to the vintage gems of yesteryear. In those early days of amplification, the only rectifiers available were tubes. Unbeknownst to their creators, these sweet-sounding amplifiers would become undesirable relics for a time for some players. The demand for higher volumes and more power per package arose. This led to the abandonment of the tube rectifier in favor of the cost-effective silicon diode’s greater efficiency and more regulated delivery of current in the late 60s. With this decision went some of the sweetness in terms of “breathing quality” and harmonic layering, along with the forgiving, bouncy, tactile quality in terms of feel. By the mid-70s, amps were bold, loud, and efficient, and in many cases, lacking some of the earlier “Soul” and Vibe of the tube-rectified amplifiers of days gone by.

We wanted the 90s Dual Rectifier to recapture that “thing you can’t quite put your finger on...but you know when it’s got it.” Soul, Personality, and Feel. The TUBE position of the RECTIFIER SELECT switch gives you a sweetness of sound and a bouncy, dynamically inviting feel that simply cannot be duplicated in any other way.

The TUBE mode shines for single note lead work in either channel and delivers a warm, breathing, 3-D sound, especially flattering to clean sounds in the Orange channel’s CLEAN mode that is somewhat rare in all but the best of the still-functioning vintage amps.

For high-gain applications, TUBE provides a way to soften and compress the sound without losing gain or girth. While it will not track as tight or reproduce low end quite as efficiently or dynamically as the silicon diodes, it adds another dimension to Heavy sounds that is addictive sounding and feeling and a bit more three-dimensional in terms of landscape.

NOTE: It is possible and perfectly fine to run only two of the four 6L6 (or EL34 tubes—as long as the Bias Switch matches the Tubes in use!) and pull the two center tubes (once they’ve cooled!), leaving the far left and far right power tubes in place, to achieve a “Half-Power” scenario. This reduces the overall power by approximately

50% but it may not seem so, as the amp is still seeing current supplied from a 100-Watt Spec'd Transformer and power supply.

NOTE: Remove one of the Rectifier tubes (once cooled!) if you are using the Tube setting of the RECTIFIER SELECT switch to ensure a correct match and achieve a response more closely resembling a 50-watt amplifier.

NOTE: It is advisable, though not absolutely necessary when running only two power tubes (far left / far right) for a 50-watt scenario to move your 8 Ohm Cabinet to one of the 4 Ohm SPEAKER OUTPUT jacks. This will result in a more correct impedance match and a punchier, brighter sound you may prefer.

BIAS SELECT

To add to the already awesome array of onboard features, we felt it essential that the 90s Dual Rectifier be able to adapt its power output section to use the other classic pentode power tube, the British-style EL34. These tubes are largely responsible for the signature sound of many immediately identifiable and wonderful-sounding amps created in Great Britain and used on some of the best rock recordings to date.

The nature of their sound is brighter and more layered in the extremely high frequencies creating a halo effect and a shimmer that is precious for certain sounds, especially Crunch Rhythm sounds. Aficionados of this EL34 sound know that nothing has the lushness of harmonics or "spread" like a power amp running EL34s. The EL34s showcase a region of upper harmonics and have a midrange character that 6L6s don't enhance and color in the same ways.

These characteristics are sometimes preferred for sound ranging from a soft clip that could be used for chording or soloing, to an all-out high gain wall of Crunch or searing lead sound. Players that lean toward or have grown up on these sounds may prefer the EL34s to the 6L6s that ship standard in the 90s Dual Rectifier.

If you rely on a clean chording sound much of the time and also need a variety of sounds and versatility, you may prefer the stock compliment of 6L6s. We feel the 6L6 is a more balanced sounding tube that produces plenty of harmonic lushness while at the same time delivering the rich lows that are crucial to both a warm clean sound and huge, tight, modern high gain Crunch sounds.

We recommend the 6L6 for reliability: In our many tests and continued use of the currently available EL34-type power tubes on the market today, we regret to say that they do not appear to be quite as rugged in construction as the available 6L6s. This is another reason why your 90s Dual Rectifier was shipped with 6L6 power tubes. If you plan to use the EL34s, we suggest that you keep a full set of tubes and extra fuses with you during all performances in the event of a tube failure occurring when using the currently available EL34s.

Make sure that the BIAS Switch setting matches the tube type in use! Failure to do this will result in tube failure that could possibly burn resistors in your amplifier. Although this is a fairly simple repair for an authorized technician, it is easily avoidable. **ALWAYS CHECK THE BIAS SWITCH setting if you experiment with alternate tube types** and you will enjoy uninterrupted performance from your amplifier.

That wraps up the review and instruction on your new 90s Dual Rectifier. We sincerely hope you get inspiration and enjoyment from this instrument for many, many years to come. May it serve you well on your musical journey and be a springboard for your development as a player, regardless of style or purpose. Please keep this Owner's Guide around should you ever need to reference features or applications. There's a lot in this amplifier and you may find you use only part of its versatility for a time and later find you'd like to explore more of it, in which case it will all be here for you.

From ALL of us here at MESA/Boogie, Thank You for trusting us to be your amplifier company! It's an honor we don't take for granted. Should you ever need us, we're here and happy to help, so feel free to reach out and ask to speak with one of our Product Specialists!

Enjoy!

FACTORY SAMPLE SETTINGS

CLEAN

ORANGE CHANNEL GAIN (REAR PANEL): CLEAN RHYTHM

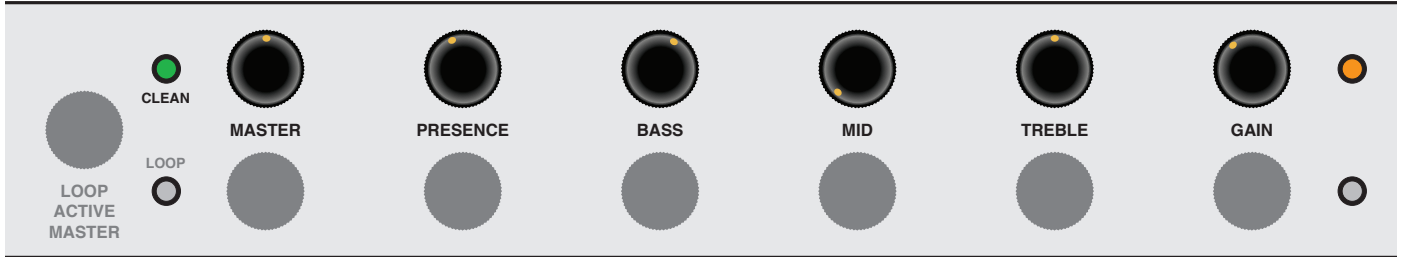

POWER SWITCH (FRONT PANEL): SPONGY or BOLD

RECTIFIER SELECT (REAR PANEL): VACUUM TUBES

PURRING BLUES

ORANGE CHANNEL GAIN (REAR PANEL): VARIABLE HIGH GAIN

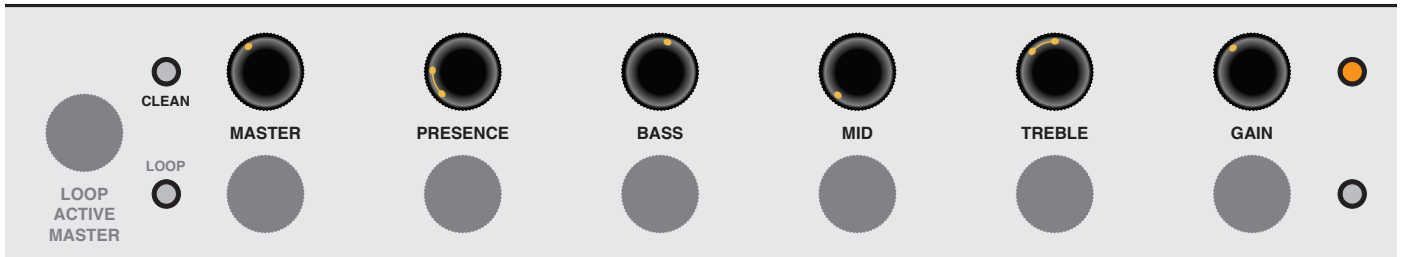

POWER SWITCH (FRONT PANEL): SPONGY or BOLD

RECTIFIER SELECT (REAR PANEL): VACUUM TUBES

LIQUID METAL / TIGHT MOSH

ORANGE CHANNEL GAIN (REAR PANEL): VARIABLE HIGH GAIN

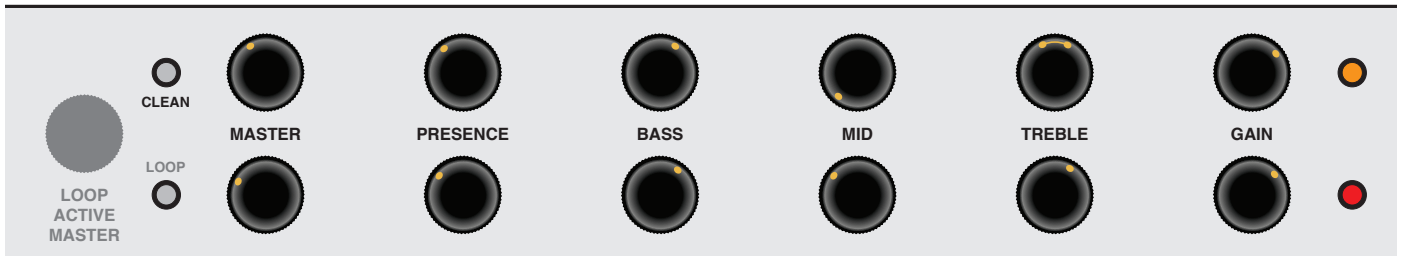

POWER SWITCH (FRONT PANEL): SPONGY or BOLD

RECTIFIER SELECT (REAR PANEL): VACUUM TUBES or SILICON DIODES

ORANGE CRUNCH / MOLTEN RED

ORANGE CHANNEL GAIN (REAR PANEL): VARIABLE HIGH GAIN

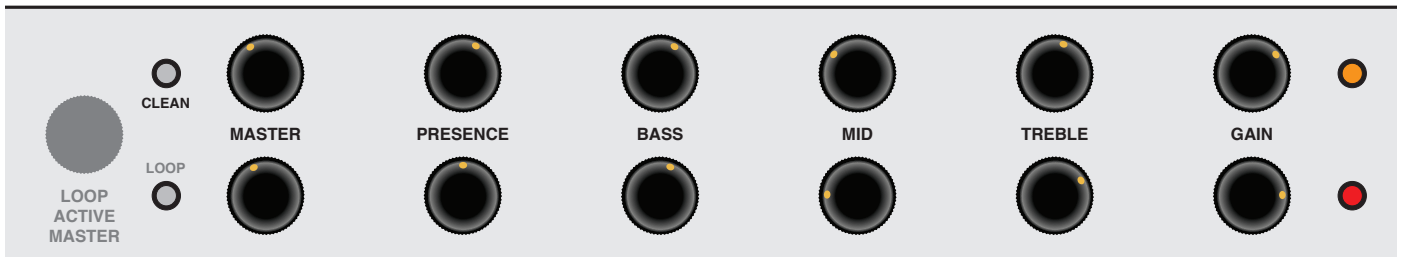

POWER SWITCH (FRONT PANEL): BOLD

RECTIFIER SELECT (REAR PANEL): SILICON DIODES

USER SETTINGS

<input type="radio"/>	<input type="radio"/>	<input type="radio"/>	<input type="radio"/>	<input type="radio"/>	<input type="radio"/>	<input type="radio"/>	<input type="radio"/>	<input type="radio"/>
LOOP ACTIVE MASTER	CLEAN	MASTER	PRESENCE	BASS	MID	TREBLE	GAIN	
<input type="radio"/>	<input type="radio"/>	<input type="radio"/>	<input type="radio"/>	<input type="radio"/>	<input type="radio"/>	<input type="radio"/>	<input type="radio"/>	<input type="radio"/>
	LOOP							

<input type="radio"/>	<input type="radio"/>	<input type="radio"/>	<input type="radio"/>	<input type="radio"/>	<input type="radio"/>	<input type="radio"/>	<input type="radio"/>	<input type="radio"/>
LOOP ACTIVE MASTER	CLEAN	MASTER	PRESENCE	BASS	MID	TREBLE	GAIN	
<input type="radio"/>	<input type="radio"/>	<input type="radio"/>	<input type="radio"/>	<input type="radio"/>	<input type="radio"/>	<input type="radio"/>	<input type="radio"/>	<input type="radio"/>
	LOOP							

<input type="radio"/>	<input type="radio"/>	<input type="radio"/>	<input type="radio"/>	<input type="radio"/>	<input type="radio"/>	<input type="radio"/>	<input type="radio"/>	<input type="radio"/>
LOOP ACTIVE MASTER	CLEAN	MASTER	PRESENCE	BASS	MID	TREBLE	GAIN	
<input type="radio"/>	<input type="radio"/>	<input type="radio"/>	<input type="radio"/>	<input type="radio"/>	<input type="radio"/>	<input type="radio"/>	<input type="radio"/>	<input type="radio"/>
	LOOP							

<input type="radio"/>	<input type="radio"/>	<input type="radio"/>	<input type="radio"/>	<input type="radio"/>	<input type="radio"/>	<input type="radio"/>	<input type="radio"/>	<input type="radio"/>
LOOP ACTIVE MASTER	CLEAN	MASTER	PRESENCE	BASS	MID	TREBLE	GAIN	
<input type="radio"/>	<input type="radio"/>	<input type="radio"/>	<input type="radio"/>	<input type="radio"/>	<input type="radio"/>	<input type="radio"/>	<input type="radio"/>	<input type="radio"/>
	LOOP							

DIAGNOSING PRE-AMP TUBE PROBLEMS

Because your amplifier is an all tube design, it is quite possible that you will at some point experience minor pre-amp tube noise. Rest assured - this is no cause for alarm and you can take care of the problem yourself in a matter of minutes by simply swapping tubes.

Let us begin by saying; It is a “very good” idea to keep at least a couple of spare pre-amp tubes on hand at all times to insure uninterrupted performance. These minor pre-amp tube problems can take many forms but can generally be described in two categories: Noise and Microphonics. Noise can be in the form of crackling, sputtering, white noise/hiss and/or hum. Microphonic problems usually appear in the form of a ringing or high pitched squealing that gets worse as the gain or volume is increased thus are more noticeable in the higher gain “HI” modes. Microphonic problems are easily identified because the problem is still present even with the instruments’ volume off or unplugged altogether - unlike pick-up feedback which ceases as the instrument is turned down. Microphonic noise is caused by mechanical vibration and shock: think of banging a microphone around and you’ll understand where the word came from.

The best way to approach a pre-amp tube problem is to see if it occurs only in one specific mode or channel. This should lead you to the tube needing replacement. Then all that remains is to swap the suspect tube for a known good performer. If you cannot narrow down the trouble to a specific mode or channel, the problem may be the small tube that drives the power tubes which is operational in all modes and channels. Though rare, a problem with the driver tube would show up in all aspects of performance - so if you can’t narrow the problem down to being mode or channel specific, you may want to try replacing the driver tube. driver problems generally show themselves in the form of crackling or hum in all modes of performance and/or weak overall output from the amplifier. Occasionally an anemic driver tube will cause the amplifier to sound flat and lifeless, but this is somewhat uncommon, as worn power tubes are a more likely suspect for this type of problem.

Sometimes making the diagnosis is more trouble than it’s worth and it’s faster and easier to merely replace the small pre-amp tubes **ONE AT A TIME** with a replacement known to be good. But **MAKE SURE** you keep returning the tubes to their original socket until you hit the one that cures the problem. You’ll notice that tubes located nearer to the INPUT jack always sound noisier...but this is because they are at the start of the chain and their noise gets amplified over and over by the tubes that follow. The tube that goes into this “input socket” (usually labeled V1) needs to be the least noisy of the bunch. The tube that goes at the end of the preamp chain - just ahead of the power tubes - can be quite noisy without causing any problem at all. The tubes in your amp have already been located in the most appropriate sockets and this is why you should **NEVER** pull them all out at once and **ALWAYS** swap them one at a time. **ALWAYS** return a perfectly good tube to its original socket. Also it’s a good idea to put the amp on **STANDBY** when swapping tubes to reduce the heat build up in the tubes themselves and to prevent explosive noises (which can still occur even if you are pulling the tubes away from their sockets gently) from coming through the speaker.

Remember, take your time, be patient and chances are real good that you can fix your amp yourself by finding and replacing the bad tube. It kills us to see someone who has shipped their amp back to us...and all it needed was a simple tube replacement! If you must send back your amp, remove the chassis from the cabinet by unscrewing the four mounting bolts on the bottom top. The chassis then slides back like a drawer and comes out from the back. Remove the big power tubes and mark them according to their location from left to right 1, 2 etc. They need to be wrapped separately with plenty of wadded up newspaper around them and put in a smaller box within the larger carton. Remove the Rectifier tubes and wrap them also. You can leave the preamp tubes in or remove them and wrap them separately being sure to label their location. (See tube Task Chart.)

To wrap the chassis, use plenty of tightly wadded up newspaper so there is at least six inches of “crush space” between the chassis and the cardboard box. Bubble wrap also works well, but please **DON’T** use styrene peanuts - they will shift during transit and get lodged inside your electronics as well as allowing your amp to end up at the bottom of the box unprotected and possibly damaged.

Pre-amp tubes don't normally wear out as a rule. Therefore, it is not a good idea to change them just for the sake of changing them. If there isn't a problem - don't fix it. If there is no result from your substitutions, it may be possible that you have more than one problematic tube. Though rare, this does happen and though it makes the troubleshooting process a little more intimidating, it is still possible to cure the problem yourself.

NOTE: It is normal to hear a slight metallic ringing sound when tapping on the preamp tubes. As long as the tube does not break into oscillation or start crackling or any other form of bizarre noise, it is considered normal and functional.

TUBE NOISE & MICROPHONICS

You may occasionally experience some form of tube noise or microphonics. Certainly no cause for alarm, this quirky behavior comes with the territory and the tone. Much like changing a light bulb, you don't need a technician to cure these types of minor user serviceable annoyances and in fact, you'll be amazed at how easy it is to cure tube problems...by simply swapping out a pre-amp or power tube!

First may we suggest that you set the amplifier up on something so that you can get to the tubes comfortably without having to bend down. It also helps to have adequate lighting as you will need to see the tube sockets clearly to swap tubes. Use caution and common sense when touching the tubes after the amplifier has been on as they may be extremely hot! If they are hot and you don't want to wait for them to cool off, try grasping them with a rag and also note that the glass down around the bulbous silvery tip is considerably less hot which makes it easier to handle. Gently rock the tube back and forth as you pull it away from its socket.

DIAGNOSING POWER TUBE FAILURE

There are two main types of tube faults: shorts and noise. Both large and small tubes may fall prey to either of these problems but diagnosis and remedy is usually simple.

If a fuse blows, the problem is most likely a shorted power tube and shorts can either be mild or severe. In a mildly shorted tube the electron flow has overcome the control grid and excess current flows to the plate. You will usually hear the amp become distorted and begin to hum slightly. If this occurs, quickly look at the power tubes as you switch the amp to STANDBY and try to identify one as glowing red hot. It is likely that two of a pair will be glowing since the "shorted" tube will pull down the bias for its adjacent mates, but one tube may be glowing hotter — and that one is the culprit. The other two are often fine — unless they've been glowing bright red for several minutes.

Because there is no physical short inside the tube (just electrons rioting out of control) merely switching to STANDBY for a few moments then back to ON will usually cure the problem...at least temporarily. Watch the tubes carefully now. Should the problem recur, the intermittent tube will visibly start to over heat before the others and thus it can be identified. It should be replaced with one from the same color batch, shown on its label. Call us and we will send one out to you.

The severe short is not nearly so benign. In the worst cases, a major arcing short occurs between the plate and the cathode with visible lightning inside the glass and a major noise through the speaker. If this is seen to happen, IMMEDIATELY turn the amp to STANDBY. By this time the fuse probably will have blown. Such a short is usually caused by a physical breakdown inside the tube including contaminate coming loose or physical contact (or near contact) between the elements. Replace it and the fuse with the proper slo-blo type and power up the amp using the power up procedure as we described earlier in this manual.

TUBE NOISE

Often caused by contamination within in a tube, the culprit can usually be identified, and by lightly tapping on the glass, you will probably hear the noise change. Hearing some noise through the speakers while tapping on the 12AX7's is normal however. And the one nearer the INPUT will always sound louder because its output is being further amplified by the second 12AX7.

The power tubes should be all but quiet when they are tapped. If crackling or hissing changes with the tapping, you have probably found the problem. To confirm a noisy power tube, merely put the amplifier on Standby, remove it from its socket and turn it back on. It will cause no damage to run the amplifier briefly with one power tube missing. You may notice a slight background hum, however, as the push-pull becomes unbalanced. Whenever you are trying to diagnose a suspect tube, keep your other hand on the POWER and STANDBY switches ready to shut them off instantly in the unlikely case you provoke a major short.

If you think you've located a problem tube but aren't sure, we recommend substituting the suspect with a new one just to be sure of your diagnoses. You will be doing yourself and us a big favor by just following the simple guidelines previously mentioned regarding tube replacement. You'll probably be successful with much less effort than is required to disconnect everything and haul the unit to a technician who will basically perform the same simple tests. If the tubes are still within their six-month warranty period, we will happily send you a replacement. Just note the color designation on the tube label so that we can send you the appropriate match.

SPEAKER IMPEDANCE MATCHING & HOOK-UP GUIDE

IMPEDANCE

Wiring up speakers to provide the most effective load and making sure that all of them are in phase will help in creating the best sound possible. This is not too difficult, as long as you understand a few things about loading and how to connect your speakers to provide an optimal resistive load.

MESA/Boogie amplifiers can handle 4 and 8 ohms effectively. Never run below 4 ohms in a tube amplifier unless you are absolutely certain that the system can handle it properly; this can cause damage to the output transformer. A few amplifiers can handle 2 ohms effectively without damaging them (for example the MESA'S bass 400+). You can always have a higher resistance (16 ohms, for example) without damaging results, but too low of a resistance will likely cause problems.

MIS-MATCHING

When running a higher resistance (for example: 8 ohm output into 16 ohm cabinet), a slightly different feel and response will be eminent. A slight mismatch can provide a darker smoother tone with a little less output and attack. This response is a result of the amplifier running a bit cooler. Sometimes when using more than one cabinet a mismatch will be the only option.

WHAT IS MY CABINETS IMPEDANCE?

If you have only a single speaker, you just match that single speakers impedance to the amplifier, and you are done. In many cases, you will have a number of speakers, and then you must calculate the "load" that the amplifier will need to support. There are generally three ways to wire multiple speakers together. They are as follows:

SERIES

When you wire (hook-up) speakers in series, the speakers resistance (as measured in ohms) is additive - i.e. putting two 8 ohm speakers in series results in a 16 ohm load.

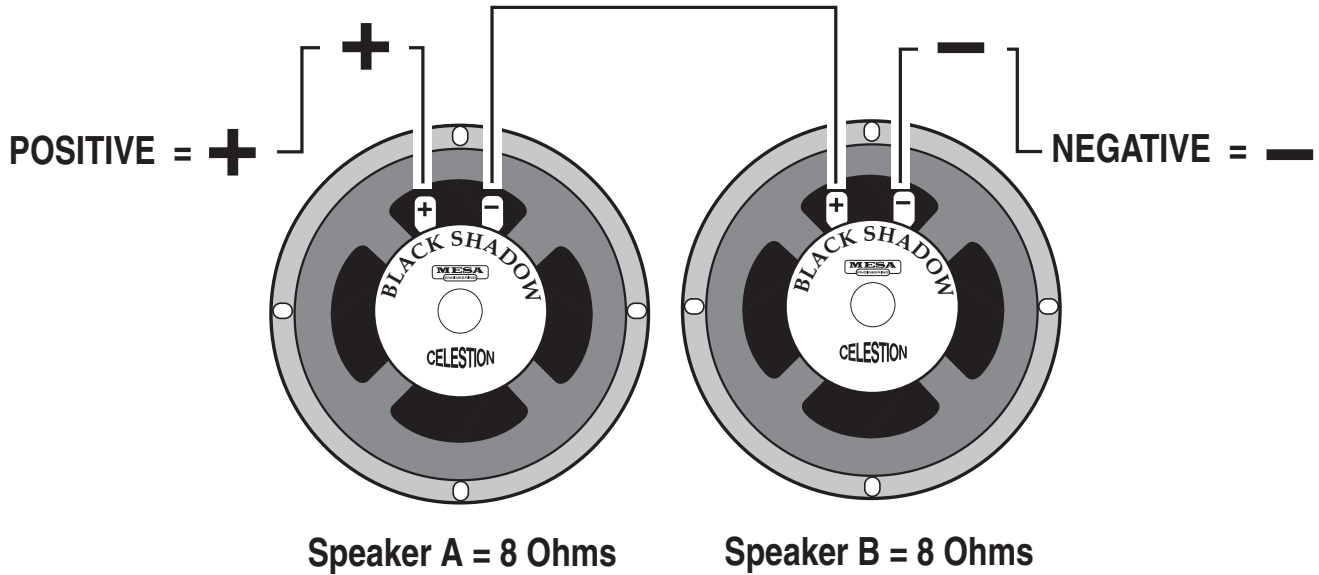

SERIES: Connect the Negative side of Speaker A to the Positive side of Speaker B

PARALLEL

When wiring in parallel, the resistance of the speakers decreases. Two 8 ohm speakers wired in (hooked-up) Parallel results in a 4 ohm load. It's easy to calculate the effect of a resistive load when all the speakers are all the same resistance. It is really not suggested to wire different resistive load values in Parallel (8 and 4, 16 and 8 etc.) The formula for figuring the total impedance in Parallel is the multiplication of the two loads divided by the sum of the two loads - i.e. putting two 8 ohm speakers in Parallel results in a 4 ohm load. Connect the Positive side of Speaker A to the Positive side of Speaker B - Connect the Negative side of Speaker A to the Negative side of Speaker B.

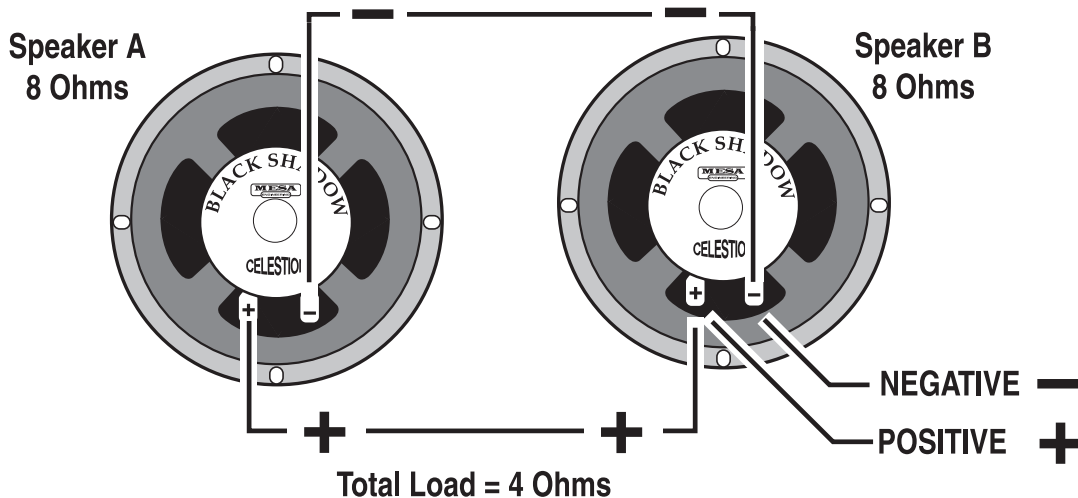

COMBINATION OF SERIES & PARALLEL

This is really just two sets of series wired speakers connected in Parallel. This is how you maintain a consistent load with multiple speakers. The importance of this is more evident when you have more than one cabinet to connect to your amplifier. This is when you need to figure out the loads and how to wire them up without applying too low of a resistance on the amplifier.

Simply connect the Positive side of Speaker A to the Positive side of Speaker C.

Connect the Negative side of Speaker A to the Positive side of Speaker B. Next, connect the Negative side of Speaker C to the Positive side of Speaker D.

And lastly, connect the Negative side of Speaker B to the Negative side of Speaker D.

4 Eight (8) Ohm speakers wired in series Parallel = a Total Load of 8 Ohms.

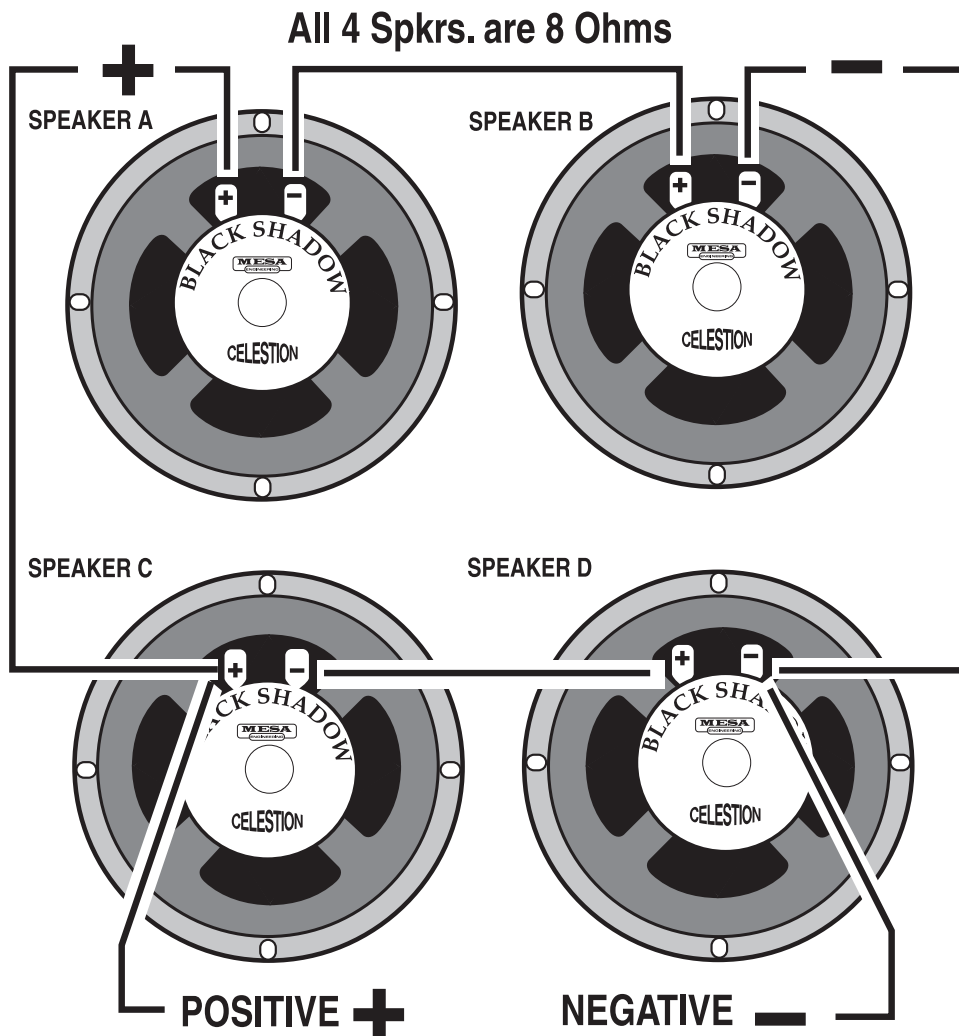

WIRING SCHEMES...Amplifier to Speaker Cabinets

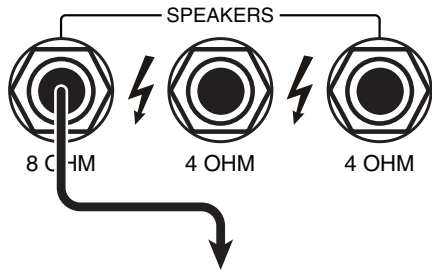

1

8 Ohm Cabinet

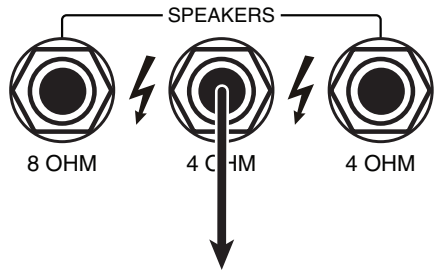

2

4 Ohm Cabinet

3

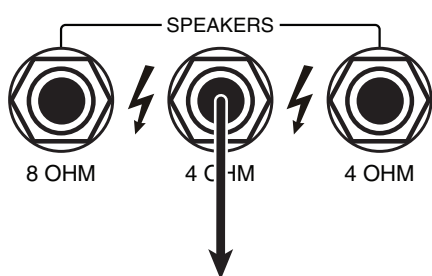

**8 Ohm Cabinet
SAFE MISMATCH**

4

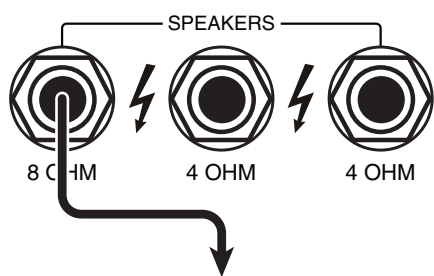

**16 Ohm Cabinet
SAFE MISMATCH**

WIRING SCHEMES...Amplifier to Speaker Cabinets

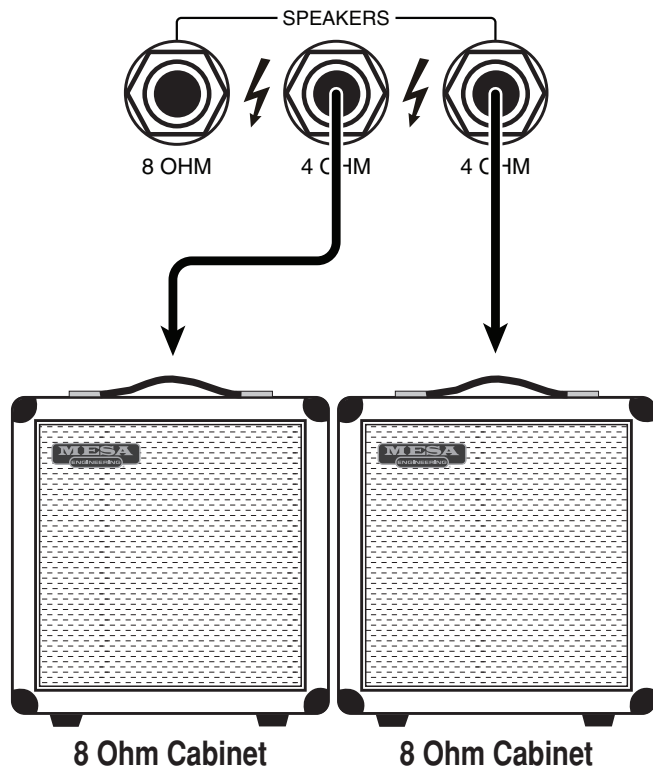

5

BEFORE CHANGING TUBES FLIP POWER & STANDBY SWITCH TO OFF

90S DUAL RECTIFIER TUBE REPLACEMENT DIAGRAM

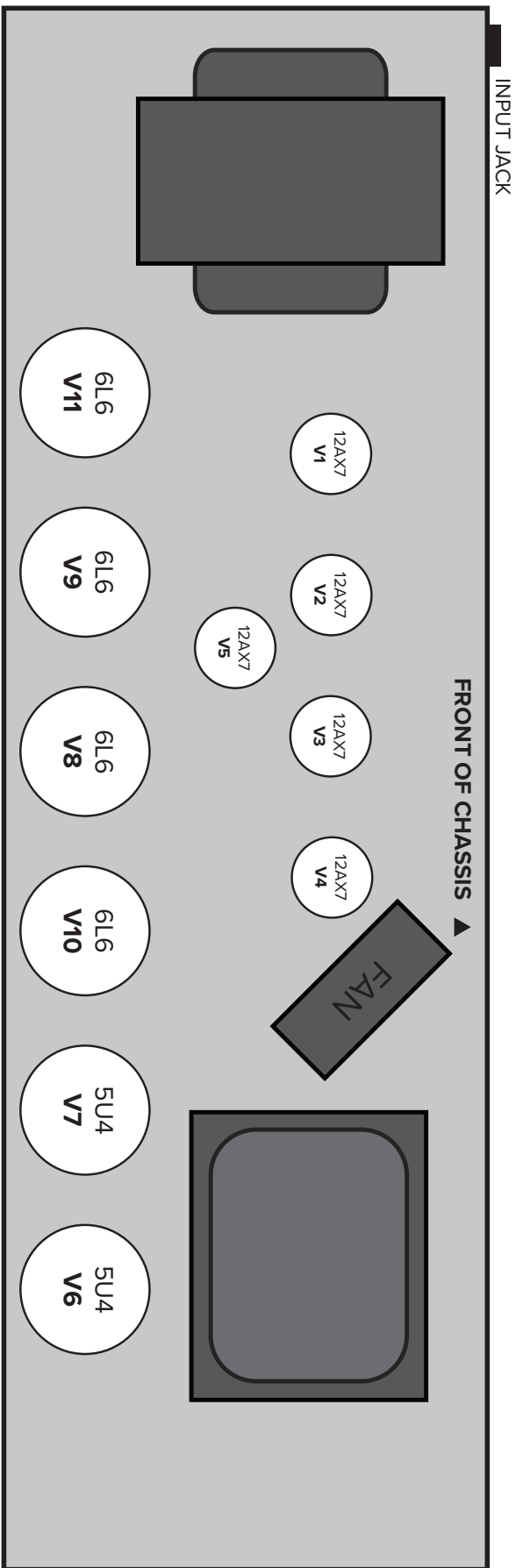

PREAMP TUBES	
V1A	Input stage
V1B	N/A
V2A	2nd Gain stage
V2B	3rd Gain stage
V3A	4th Gain stage
V3B	5th Gain stage
V4A	Effects Return stage
V4B	Effects Send stage
V5A&B	Driver/Phase Inverter

POWER TUBES
V8, V9, V10, V11

RECTIFIER TUBES
V6, V7

TO MAINTAIN WARRANTY, USE MESA/BOOGIE® TUBES WHEN REPLACEMENT IS NECESSARY
 FOR CUSTOMER SUPPORT, PLEASE CALL 707-778-6565 MONDAY-THURSDAY 9-5 PST, OR VISIT WWW.MESABOOGIE.COM

FRONT PANEL: 90s DUAL RECTIFIER

FRONT CONTROL KNOBS
408111 x13

ORANGE LED
136190

GREEN LED
136191

BOLD POWER
ON

SPONGY POWER
0

STANDBY
STANDBY

PILOT HOLDER
703850

RED JEWEL LENS
703782

YELLOW LED
136192

GREEN LED
136191

CLEAN LOOP

LOOP ACTIVE MASTER

590 148

SLAVE MASTER

590 792

PRESENCE

590 737

BASS

590 739

MID

590 737

TREBLE

590 738

GAIN

590 794

FT. SW. INPUT

590 794

POWER 600636
STANDBY 600631
PILOT HOLDER 703850
RED JEWEL LENS 703782

YELLOW LED 136192

ORANGE LED 136190

GREEN LED 136191

REAR PANEL: 90s DUAL RECTIFIER

FRONT CONTROL KNOBS
408111 x1 LARG
408301 x2 SMALL

DOMESTIC FUSE: 790403
HOLDER: 790347

EXPORT FUSE: 795200
HOLDER: 790346

CHANNEL SELECT
ORANGE

ORANGE CHANNEL GAIN
VARIABLE (NORMAL)

EXT. SW.
CHAN LOOP

DUAL RECTIFIER - SOLO/HEAD 100
ALL TUBE AMPLIFIER - HAND WIRE IN PETALUMA, CALIFORNIA, USA

SLAVE
590 378

LOOP SELECT
LOOP ON, LOOP OFF, AUTO, LOOP ON, LOOP OFF, AUTO

EFFECTS LOOP
590 736

BIAS SWITCH
6L6 EL-34

RECTIFIER SELECT
RECTIFIER SELECT

CHANNEL SELECT HI GAIN / CLEAN 607430
MODERN / VINT 607433

ALL REAR JACKS
619112 x10

GREEN LED 394232
RED LED 394201
SWITCH 607432

SWITCH 600631

IEC POWER INLET JACK 613713



SERVICE INFORMATION

- **USA /CANADA Customer Support:**

For technical support, troubleshooting, tone questions, settings help and more...
Call us at 707-778-6565, Monday-Thursday, 9AM-5PM Pacific time, or email us at
service@mesaboogie.com.

NOTE: If a Product Specialist is not available when you call (helping other customers), PLEASE leave a voice message with a phone number and a good time to call and WE'LL CALL YOU BACK!

- **INTERNATIONAL Customer Support:**

For warranty and technical support, please contact your LOCAL MESA DISTRIBUTOR.
You may use this link to search the web for your local distributor's contact information:



www.mesaboogie.com/support/

MESA/BOOGIE[®]

Thank you for trusting MESA/Boogie[®] to be your amplifier company and we wish you many years of toneful enjoyment from this handcrafted instrument.



Scan to download Mesa/Boogie product manuals in additional languages.
Or, visit www.mesaboogie.com/manuals

MESA/BOOGIE[®]

1317 Ross Street, Petaluma, CA 94954 USA • (707) 778-6565 • www.mesaboogie.com

24/11/05