

GENELEC®

8350A
8340A

Operating Manual



750-8340A/8350A

Introduction

Congratulations and a thank you for the purchase of this Genelec Smart Active Monitor (SAM) system. This manual addresses the stand-alone setup and use of the 8340A and 8350A SAM monitors. These monitors can also be set up and used with the Genelec Loudspeaker Manager GLM™ and the proprietary Genelec monitor control network and software, offering much more versatile acoustic settings and features. Use with the GLM™ is described in the GLM™ System Operating Manual.

All Genelec SAM systems are designed to integrate easily into all professional environments, supporting both standard analog line level audio and AES/EBU formatted digital audio signals.

The 8340A and 8350A are suitable for professional monitoring tasks demanding high precision and reliability of monitoring. The Minimum Diffraction Enclosure™ (MDE™) and advanced Directivity Control Waveguide™ (DCW™) technologies provide excellent frequency balance even in difficult acoustic environments.

Each monitor is supplied with a mains cable, one 5 m GLM network cable and an operating manual.

Energy saving Intelligent Signal Sensing (ISS™) can be turned on to put the monitor automatically into a deep sleep state where the product consumes less than one Watt of power. Upon sensing an input signal the monitor automatically wakes up to full operation. The wait until entering the ISS power save can be configured using the GLM software. When the ISS is active you can have your monitoring system ready for action at all times.

System setup using GLM™ Control Network

Although the 8340A and 8350A can be used without the GLM™ software and control network, they only reach their full potential when set up and calibrated using the GLM™ software. Genelec Loudspeaker Manager GLM™ and the proprietary Genelec monitor control network and software offer automated acoustic equalization and alignment for any reproduction system from simple stereo to very complex 3D immersive audio setups including also one or more subwoofers. GLM setup is fast and accurate. The settings can be controlled with a computer or be permanently stored in the monitors to make the setup available at all times even when a computer is not in use. Genelec recommends setting up SAM monitoring systems using GLM. You can find a detailed description of the setup and the use of GLM™ in the GLM™ System Operating Manual.

The setup is fast and consists of the following steps:

- Connect a CAT5 (RJ45) cable between each monitor (and subwoofer) and finally to the control network input of the GLM Adapter device (see Figure 1).
- Connect the GLM Adapter device to computer USB connector.
- Using a microphone stand, place the Genelec measurement microphone at the listening location with the microphone pointing upwards and the microphone top at the height of the engineer's ear. The microphone is a part of the GLM User Kit.

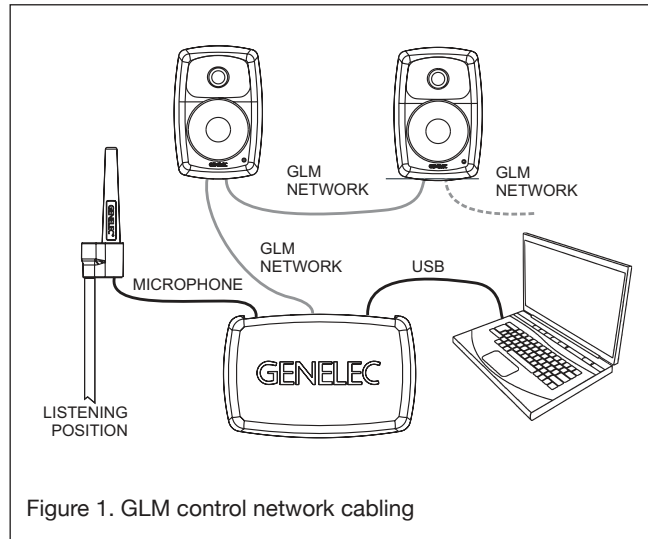

Figure 1. GLM control network cabling

- Connect the microphone cable to the microphone input in the GLM Adapter device.
- Download the GLM software at the Genelec web site (www.genelec.com).
- Install the GLM software and follow the instructions in the software to measure and set up your monitors.
- If you plan to not use a computer for controlling the monitors, use the GLM software to write the setting into the monitors (use menu item "Store | Store the Current Group Settings...").

While the GLM network is disconnected the settings stored using the Genelec Loudspeaker Manager software can be selected in use by setting the STORED switch ON.

Setup without using the GLM

When GLM is not available, you can use the settings on the monitor for system setup. These settings are limited but provide the basic acoustical calibrations and input selection. To use this method, set the STORED switch OFF.

Connect the MAINS INPUT to the mains supply. These products support any mains voltage globally (100-240 VAC, 50-60 Hz) so they can be plugged in anywhere. If the mains power is provided with a generator, inverter or certain lower-quality UPS devices, we recommend filtering of the mains power voltage harmonics and taking care that the voltage supply is stable.

The ANALOG IN connector is used for analog audio signals. The maximum input level is +25 dBu. These monitors produce 100 dB SPL sound level at 1 meter in free space for an analogue input signal of -6 dBu.

The DIGITAL IN AES/EBU female XLR connector is for AES/EBU formatted digital audio input signals. This input is selected automatically when a valid digital audio signal is present. Analog input is selected when the AES/EBU signal input is disconnected. The AES/EBU input supports two channels in a single cable. When the digital source device controls the digital output level, it may be advantageous to lower the level on the monitor's controls, which will enable the use of a higher digital signal level with more digital resolution. With digital inputs the audio is referenced to 0 dBFS (dB relative to the digital full scale, the largest level that can be represented in the AES/EBU signal).

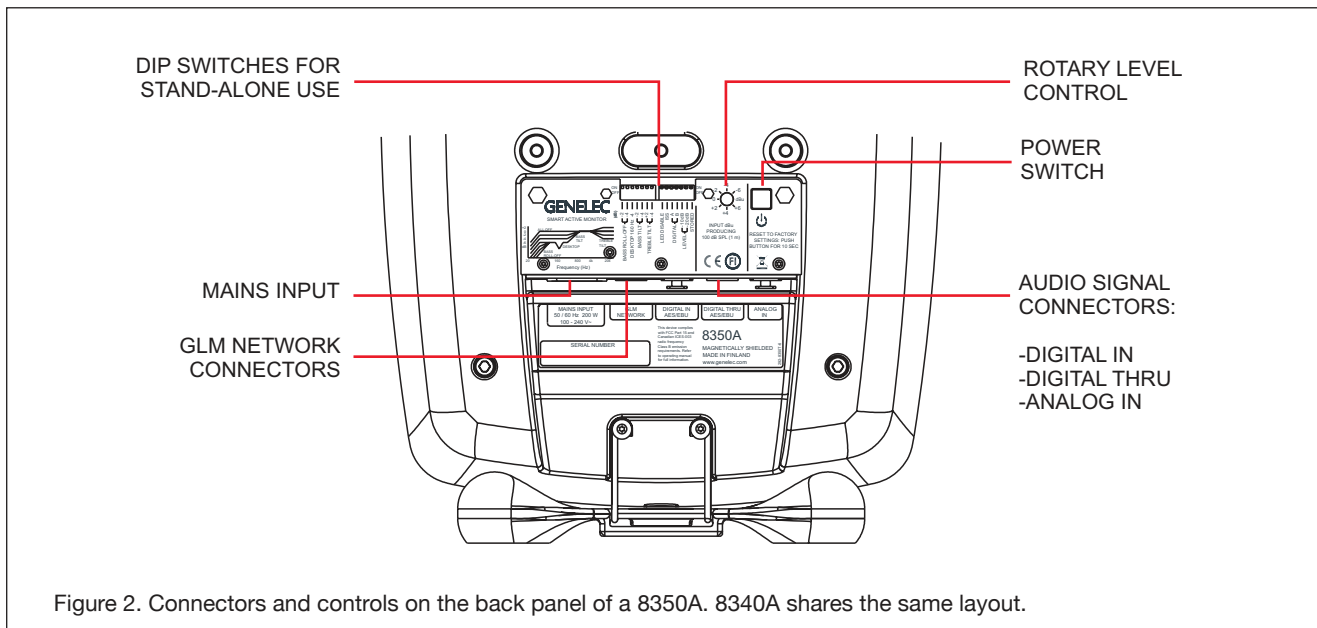

Figure 2. Connectors and controls on the back panel of a 8350A. 8340A shares the same layout.

These monitors produce 100 dB SPL sound level at 1 meter in free space for a digital input signal of -30 dBFS. The DIGITAL OUT male XLR carries an unaltered copy of the digital signal fed into the digital in connector. This enables daisy-chaining up to four monitors.

The CONTROL NETWORK RJ-45 connectors are used with Genelec Loudspeaker Manager™ (GLM™) network. These connectors are not Ethernet LAN compatible. Do not connect to Ethernet LAN.

Stand-Alone Control Functions

Bass Roll-Off Control

Bass Roll-Off control attenuates the monitor’s output near the cut-off frequency. Attenuation levels of -2 dB, -4 dB or -6 dB (both switches ON) can be selected.

Desktop 160 Hz

The desktop low frequency control (switch 5) attenuates the bass frequencies around 160 Hz by 4 dB. This feature is designed to compensate for the boost often occurring at this frequency range when the monitor is placed upon a meter bridge, table or similar reflective surface.

Bass Tilt Control

The Bass Tilt control switches (switches 3 and 4) offer three attenuation levels for the bass response below 800 Hz, usually necessary when the monitors are placed near room boundaries. The attenuation levels are -2 dB, -4 dB and -6 dB.

Treble Tilt Control

Treble Tilt control allows adjusting the treble response above 5 kHz by +2 dB, -2 dB or -4 dB, which can be used for correcting an excessively bright or dull sounding system or to compensate for high frequency level loss if the monitor is placed behind a screen.

LED Disable

This switch shuts off the front panel LED light.

Monitor Mounting Position	Treble Tilt	Bass Tilt	Bass Roll-Off	Desktop
Flat anechoic response	None	None	None	None
Free standing in a damped room	None	-2 dB	None	None
Free standing in a reverberant room	None	-4 dB	None	None
Near field on a reflective surface	None	-2 dB	None	-4 dB
In a corner	None	-4 dB	-4 dB	None

Table 1. Suggested Tone Control settings for some typical monitor placement positions.

ISS

This switch activates or deactivates the ISS automatic power saving function. The default time for ISS activation is 60 minutes, but can be adjusted in GLM.

Digital

The Digital switch selects the digital audio channels on the AES/EBU. Turning both switches on reproduces the sum of the A and B channels. A 6 dB of attenuation is applied to avoid overloading the monitor. If the AES/EBU cable is operated in dual-wire mode, the monitor detects this automatically and the channel selection switches have no effect.

Level

The Level switches scale down the monitor output level in 10 dB steps. The effects of these switches add up and combine with the effect of the rotary level adjustment control. The combined total setting range is 42 dB.

Stored

Stored switch selects the use of the controls on the monitor’s back panel or the settings stored inside the monitor memory using the GLM system calibration software. Setting the Stored switch to OFF position selects the settings defined by the monitor’s own controls. Setting the Stored switch to ON position selects the use of internally stored GLM settings. Using the

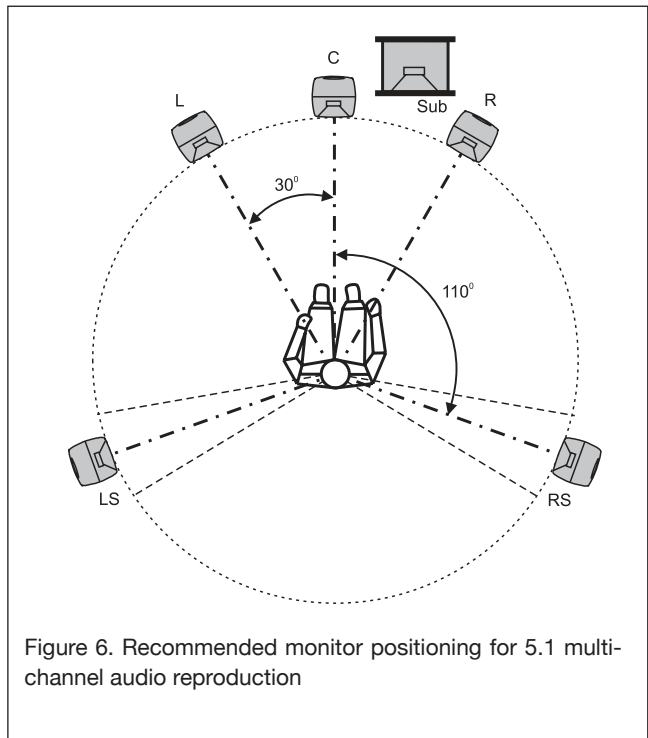
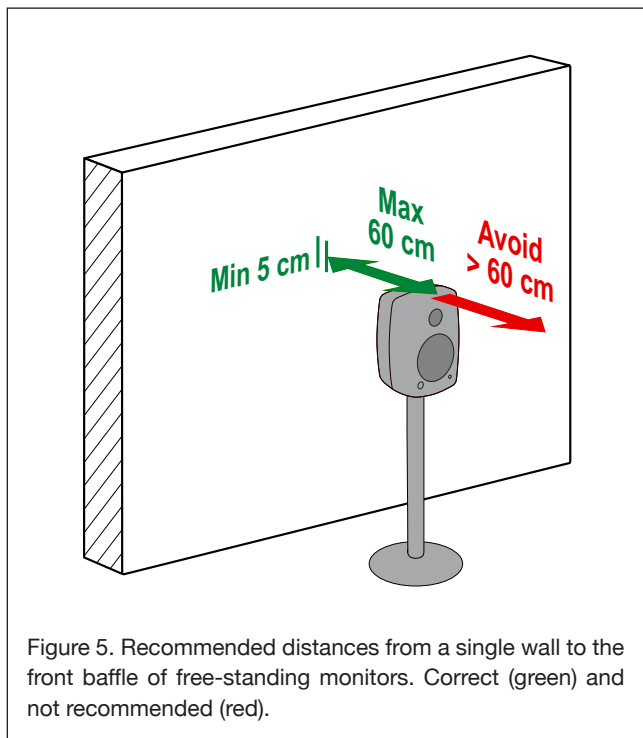
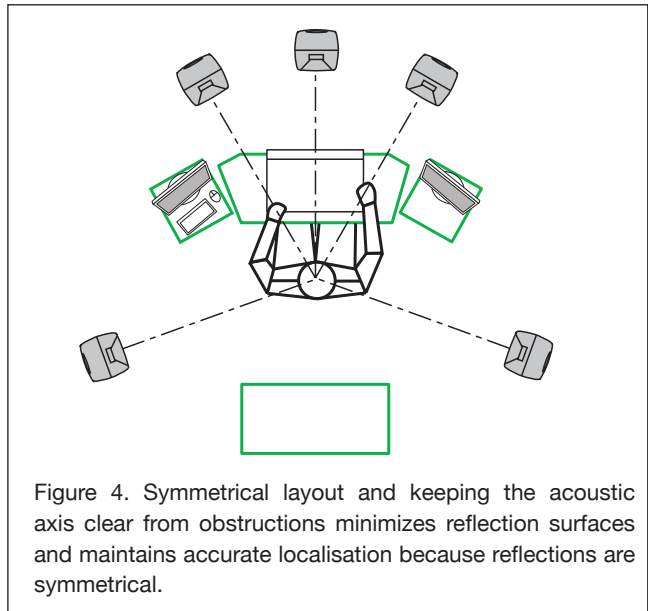
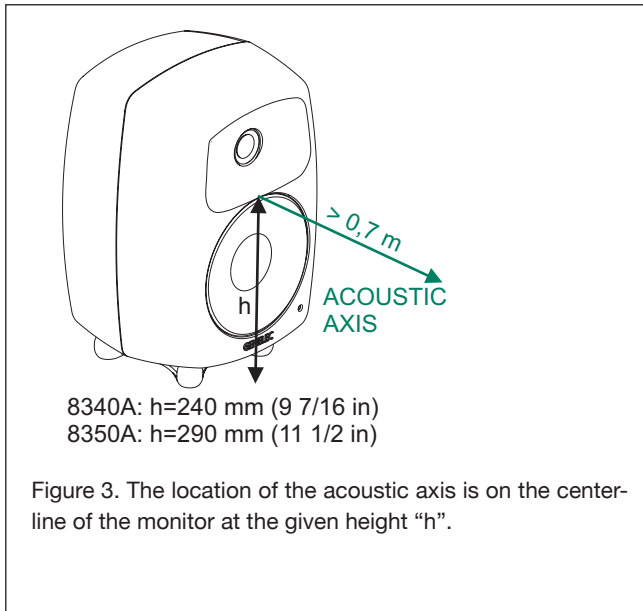

Stored option overrides all adjustments done with the monitor’s own controls.

Operating Environment

These monitors are designed for indoor use only. The permissible ambient temperature is 15-35 degrees Celsius (50-95°F) and relative humidity 20% to 80% (non-condensing). When the product has been stored or transported in cool environment and is taken into a warm room, wait 0.5-1 hours before opening any packing to prevent condensation of humidity before connecting to mains power. Sufficient cooling must be ensured. The minimum clearance is 50 mm (2 in) behind, above and on both sides of the monitor. The space must be ventilated sufficiently to dissipate the heat.

Mounting and Placing Monitors

Mounting Options

The vibration insulating Isolation Positioner/Decoupler™ (Iso-Pod™) table stand allows tilting of the monitor for correct alignment of the acoustic axis. The stand can be attached to three points on the enclosure, allowing vertical and two horizontal positions. Aim the monitor so that its acoustic axis point towards the listening position (see Figure 3). Vertical orientation is preferable, as this eliminates acoustical cancellation problems around the crossover frequency. Place the monitors symmetrically at equal distances from the listening position. If possible, place the listening position on the left-right centerline of the room (see Figure 4). When a monitor far away (1 to 2.2 m, 3-7 ft) from the acoustically hard wall behind the monitor, an acoustic reflection from the wall may cause cancellation of low frequencies and reduce bass output.

Colour	Indication
Solid green	Normal state, normal operation
Blinking green	GLM is adjusting the monitor
Green blink every 10 sec.	Monitor is in an ISS power saving sleep state
Red blink	Power amplifier overload protection is active (audio is modified because of protection)
Solid red	Monitor is muted
Yellow	Monitor is not in the active (playing) group
Yellow blinking	Overheat protection is active (audio is modified because of protection)

Table 2. Monitor front panel light indications summary

Acoustic reflections from objects like desks, cabinets, computer monitors etc. can cause unwanted colouration and blurring of the sound image. Minimise these by placing the monitors away from acoustically reflective surfaces. Putting the monitors on stands behind and above a mixing console usually improves the response over placing monitors on a meter bridge. Symmetrical positioning of the sound reflecting objects maintains a balanced soundstage (see Figure 4).

A wide variety of ceiling and wall mounts are available through your Genelec dealer. Genelec 8340A and 8350A can be fitted with König & Meyer monitor mounts using two M6 x 10 mm threaded holes on the enclosure back. There is an M10 x 10 mm threaded hole in the base of the monitor. Do not use this thread for mounting the monitor on a microphone stand. Monitor stands typically have an incompatible 3/8" UNC thread. A wide selection of accessories is available for Genelec monitors. Consult the Genelec Accessories Catalogue at www.genelec.com or your local distributor/ dealer for information.

Front Panel Light

Normally, the light on the front panel is green, indicating normal operational mode. Red and yellow colours are used to indicate special situations. See Table 2 above.

Use with Subwoofers

Genelec recommends using the 7300 series subwoofers. For more detailed system configuration and matching products, please consult the on-line Genelec Product Selection Tool at www.genelec.com.

Maintenance

There are no user serviceable parts inside the monitor. Maintenance or repair must only be done by a Genelec certified service.

Safety Considerations

Although the 8340A and 8350A have been designed in accordance with international safety standards, to ensure safe operation and to maintain the monitor under safe operating conditions, the following warnings and precautions must be observed:

- Servicing and adjustment must only be performed by a certified Genelec service. The monitor enclosure must not be opened.
- Do not use this product with an unearthed mains cable or a mains connection without the protective earth contact as this may lead to personal injury.
- To prevent fire or electric shock, do not expose the unit to water or moisture.
- Do not place any objects filled with liquid, such as vases on the monitor or near it.
- Note that the amplifier is not completely disconnected from the AC mains service unless the mains power cord is removed from the amplifier or the mains outlet.
- Free flow of air behind the monitor is necessary to maintain sufficient cooling.
- Do not obstruct airflow around the monitors.

WARNING!

These monitors are capable of producing sound pressure levels in excess of 85 dB, which may cause permanent hearing damage.

Guarantee

Genelec 8340A and 8350A are guaranteed for two years against manufacturing faults or defects altering performance. Refer to the reseller for full sales and guarantee terms.

Compliance to FCC Rules

Note: This equipment has been tested and found to comply with the limits for a Class B digital device, pursuant to part 15 of the FCC Rules. These limits are designed to provide reasonable protection against harmful interference in a residential installation. This equipment generates, uses and can radiate radio frequency energy and, if not installed and used in accordance with the instructions, may cause harmful interference to radio communications. However, there is no guarantee that interference will not occur in a particular installation. If this equipment does cause harmful interference to radio or television reception, which can be determined by turning the equipment off and on, the user is encouraged to try to correct the interference by one or more of the following measures:

- Reorient or relocate the receiving antenna.
- Increase the separation between the equipment and receiver.
- Connect the equipment into an outlet on a circuit different from that to which the receiver is connected.
- Consult the dealer or an experienced radio/TV technician for help
- Modifications not expressly approved by the manufacturer could void the user's authority to operate the equipment under FCC rules.

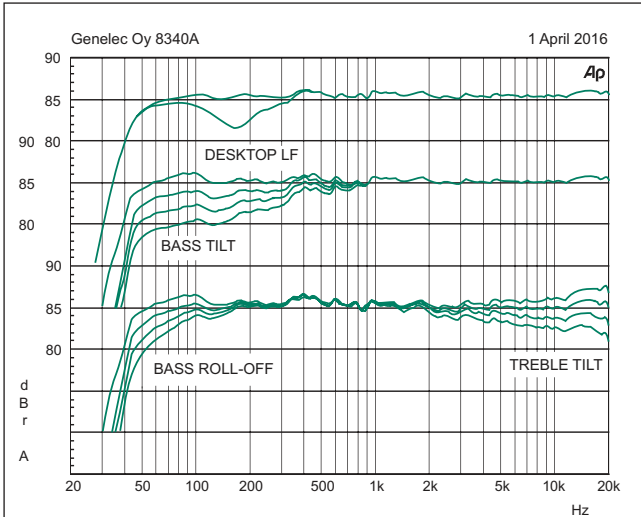

Figure 11. The curves above show the effect of the “Bass Tilt”, “Treble Tilt”, “Desktop Low Frequency” and “Bass Roll-Off” controls on the free field response of the 8340A.

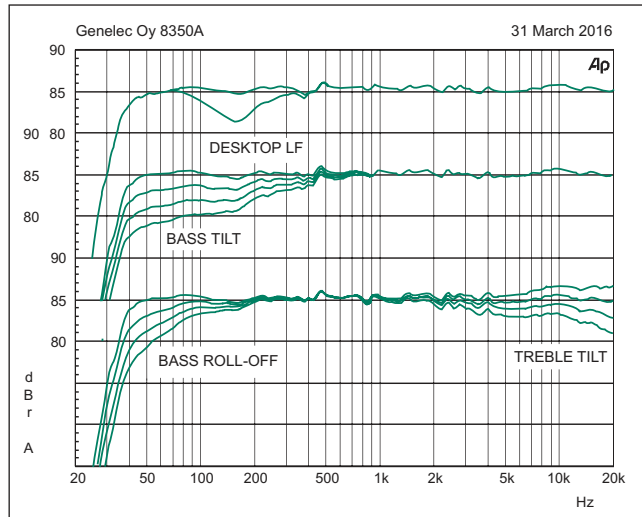

Figure 12. The curves above show the effect of the “Bass Tilt”, “Treble Tilt”, “Desktop Low Frequency” and “Bass Roll-Off” controls on the free field response of the 8350A.

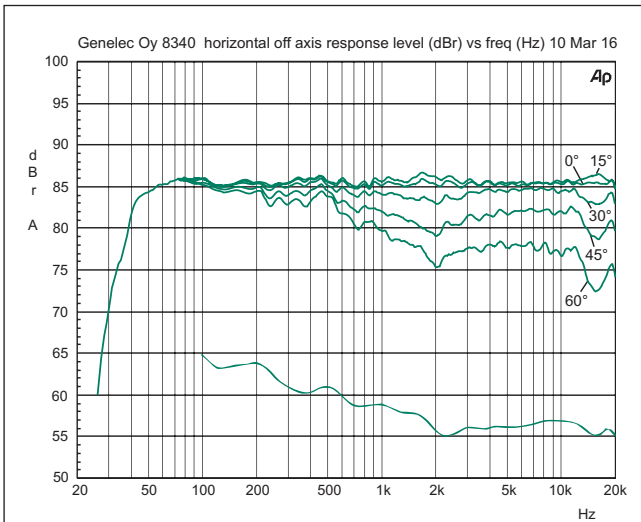

Figure 13. The upper curve group shows the horizontal directivity characteristics of the 8340A measured at 1 m. The lower curve shows the system’s power response.

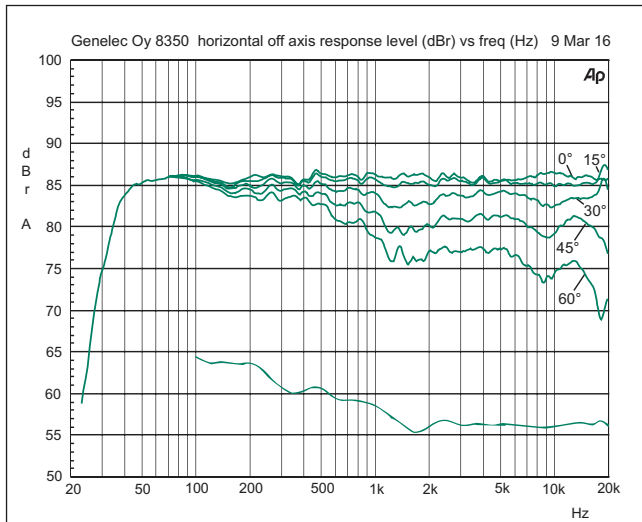

Figure 14. The upper curve group shows the horizontal directivity characteristics of the 8350A measured at 1 m. The lower curve shows the system’s power response.

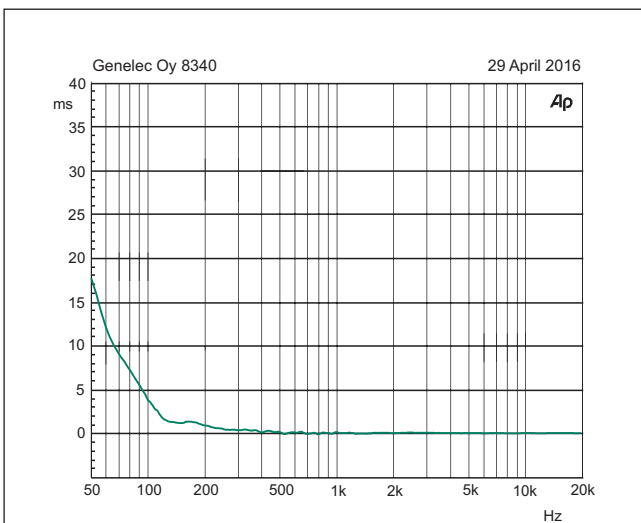

Figure 14. The curve above shows the delay variation of the 8340A as a function of frequency.

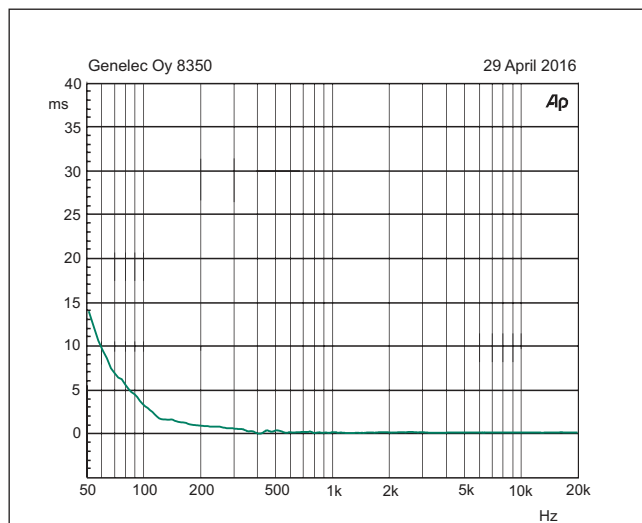
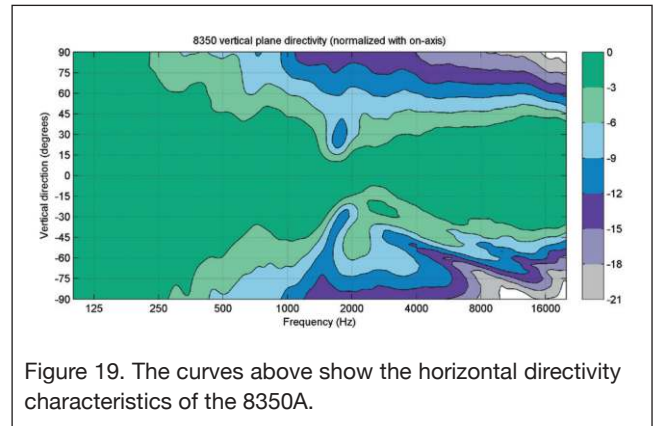
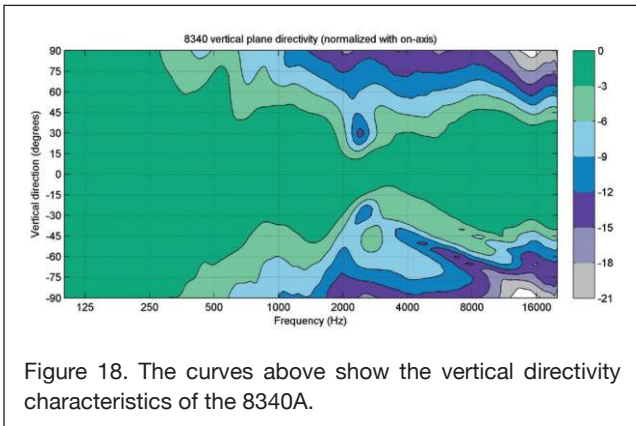
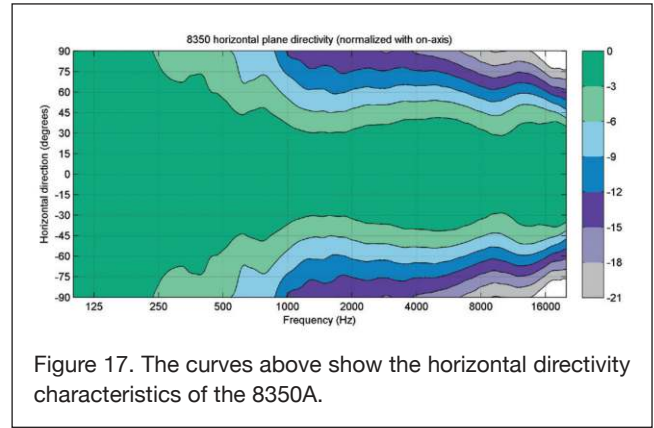
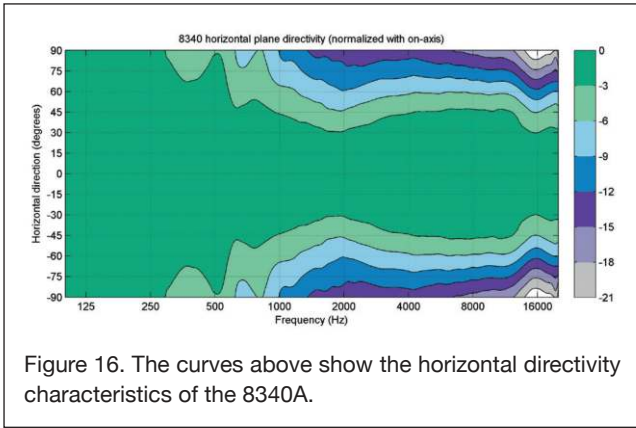

Figure 15. The curve above shows the delay variation of the 8350A as a function of frequency.



SYSTEM SPECIFICATIONS

	8340A	8350A
Lower cut-off frequency, -6 dB	< 38 Hz	< 33 Hz
Upper cut-off frequency, -6 dB	> 22 kHz	> 22 kHz
Accuracy of frequency response, ± 1.5 dB	45 Hz – 20 kHz	38 Hz – 20 kHz
Maximum short term sine wave acoustic output on axis in half space, averaged from 100 Hz to 3 kHz at 1 m	≥ 110 dB SPL	≥ 112 dB SPL
Maximum long term RMS acoustic output in the same conditions with IEC weighted noise (limited by driver protection circuit) at 1 m	100 dB SPL	103 dB SPL
Maximum peak acoustic output per pair in a listening room with music material at 1 m	≥ 118 dB	≥ 121 dB
Self generated noise level in free space at 1 m on axis (A-weighted)	≤ 5 dB	
Harmonic distortion at 90 dB SPL at 1 m on axis Freq: 50...100 Hz > 100 Hz	< 2 % < 0.5 %	
Drivers Bass Treble All drivers are magnetically shielded	165 mm (6½ in) cone 19 mm (¾ in) metal dome	205 mm (8 in) cone 25 mm (1 in) metal dome
Weight	8.4 kg (18.5 lb)	12.8 kg (28.2 lb)
Dimensions Height Width Depth Height with Iso-Pod™	350 mm (13⅓/₁₆ in) 237 mm (9⅓/₈ in) 223 mm (8⅓/₁₆ in) 365 mm (14⅞/₈ in)	433 mm (17⅓/₁₆ in) 286 mm (11¼ in) 278 mm (10⅓/₁₆ in) 452 mm (17⅓/₁₆ in)

AMPLIFIER SECTION

	8340A	8350A
Bass amplifier short term output power Treble amplifier short term output power (Long term output power is limited by driver protection circuitry)	150 W 150 W	150 W 200 W
Amplifier system THD at nominal output	<0.01%	
System Signal to Noise ratio, A-weighted Bass Treble	> 109 dB > 110 dB	> 109 dB > 112 dB
Mains voltage	100-240 VAC 50/60 Hz	
Power consumption ISS active Idle Full output (short term)	< 1 W 12 W 180 W	< 1 W 12 W 230 W

SIGNAL PROCESSING SECTION

	8340A	8350A
Analog signal input connector XLR female, balanced 10 kOhm Maximum analog input signal Analog input sensitivity (100 dB SPL at 1 m) Analog input gain selection, rotary control	pin 1 gnd pin 2 non-inverting, pin 3 inverting +25.0 dBu -6 dBu Adjustable from +6 to -6 dBu	
Digital signal input connector XLR female 110 Ohm Digital signal output / Thru connector XLR male 110 Ohm Digital audio input Word length Sample rate Digital input sensitivity (100 dB SPL at 1 m) Digital input gain sensitivity, rotary control	AES/EBU Single Wire AES/EBU Single Wire 16 - 24 bits 32 - 192 kHz -30 dBFS Adjustable from +6 to -6 dBu	
Control network Type Connection	Proprietary GLM™ network 2 RJ45, CAT5 cables	
Crossover frequency	2.6 kHz	1.8 kHz
GLM™ software frequency response adjustment* Parametric notch filters Shelving filters	16 2 LF and 2 HF	
System room response calibration	Genelec GLM AutoCal™ AutoCal™, GLM™ manual, Stand-alone*	

* The notch and shelving filters adjustments, AutoCal™ and GLM™ manual system calibration features are part of the Genelec Loudspeaker Manager (GLM™) software

GENELEC®

International enquiries:
Genelec, Olvitie 5
FIN-74100, Iisalmi, Finland
Phone +358 17 83881
Fax +358 17 812 267
Email genelec@genelec.com

In the U.S. please contact:
Genelec, Inc., 7 Tech Circle
Natick, MA 01760, USA
Phone +1 508 652 0900
Fax +1 508 652 0909
Email genelec.usa@genelec.com

In Sweden please contact:
Genelec Sverige
Ellipsvägen 10B
P.O. Box 5521, S-141 05 Huddinge
Phone +46 8 449 5220
Fax +46 8 708 7071
Email info@genelec.com

In China please contact:
Beijing Genelec Audio Co.Ltd
Room 101, 1st floor
Building 71 B33
Universal Business Park
No. 10 Jiuxianqiao Road
Chaoyang District Beijing, China
Phone +86 (10) 5823 2014
Post code: 100015
Email genelec.china@genelec.com