

FUNKEY

Funkey 61 Deluxe



Users manual

Caution

The following requirements shall be observed to avoid hurting yourself Or anybody else as well as damaging of peripheral devices. The intensions will include(but not limited to) the followings:

Cautions

AC/DC adapter:

- Please use specified AC/DC Adapter, otherwise fault adapter may cause damage of your electronic keyboard.
- Do not place AC adapter or power cord near heating source such as central heating or heat radiator.
- Regularly check power plug and clean surface dirt. Do not pull out power plug with wet hand.
- Do not overbend wire and place heavy matters on wire or wind wire with other matters to avoid damaging wire.

Do not open the casing of electronic keyboard:

- Do not open the casing of electronic keyboard and try to disassemble any part of it, nor make any Change to it. Should any abnormal function occur in use, please stop operating it immediately and send it for repair by qualified servicemen.

Location of placing electronic keyboard:

- Do not place the electronic **keyboard** in an environment of dusty, vibrating, low or high temperature (such as exposed to direct sunshine, near central heat or in the car exposed under sunshine) to avoid damaging appearance or internal part.
- Do not put the electronic **keyboard** in an unstable place to avoid falling. Do not put any vessel holding liquid on the electronic organ to avoid liquid flowing in it and impairing internal part.

Maintenance:

- To clean the body of the electronic **keyboard**, wipe it with dry soft cloth. Do not use paint, dope, organic solvent or chemically impregnated cloth.

Connection of peripheral device:

- In order to prevent speaker from damaging, please adjust the volume of peripheral device to the lowest and after music is gradually played, adjust to appropriate volume.

Caution in operation:

- Do not perform the organ with the loudest or uncomfortable volume to avoid decline in hearing.
- Do not place heavy matters on the electronic organ, nor press keyboard, switch and socket With heavy force.
- The package shall be opened by adult to avoid the danger of suffocating infant or children. Please properly store or dispose the plastic package after unpacking. The matters contained are not suitable for using by the children under 3 years old.

Notice

- Specifications are subject to change without notice.
- Should any description of product function be not specified in detail or some typing error occur, Please forgive us.
 - What is displayed in LCD in this instruction is only for the purpose of explanation and may be different with actual display in your electronic organ.
- This company retains the right which needs to revise because of the duty and finally interpretation.

Table of Contents

I.Panel Control and External Function	1
1.Panel control	1
2.External function.....	1
II.Preparation before performance	1
1.Use AC/DC power adapter.....	1
2.Use of batteries	2
Fitting Jack	2
1.Use of headphone.....	2
2.Pedal Function	2
3.USB Function	2
4. MIDI Function.....	3
III.Basic Operation	3
1.Turn on power switch	3
2. Adjustment of Volume	3
3. Accompaniment volume Adjustment.....	3
4.Tempo.....	3
5.Transpose	4
6.Metronome.....	4
Sound Selection	4
Style selection and play	4
1.Stly selection.....	4
2.Style play.....	4
3.Sync	5
4.Fill-in.....	5
5.Chord	5
6.Chord Dictionary	5
SOUND EFFECT	5
1.Sustain	5
2.Vibrato	6
3.Double keyboard	6
4.Pitch bend	6
5.Touch.....	6
6.Drum kit.....	6
DEMO Teaching.....	6
Demo songs.....	7
Memory bank.....	7
Single key setting function.....	7
Appendix I.Table of Voice	8
Appendix II.Table of Style	9
Appendix III.Table of Demo Song	10
Appendix IV.Table of chord	11
Appendix V. Technical Specifications	12

Panel Control and External Function

Panel Control

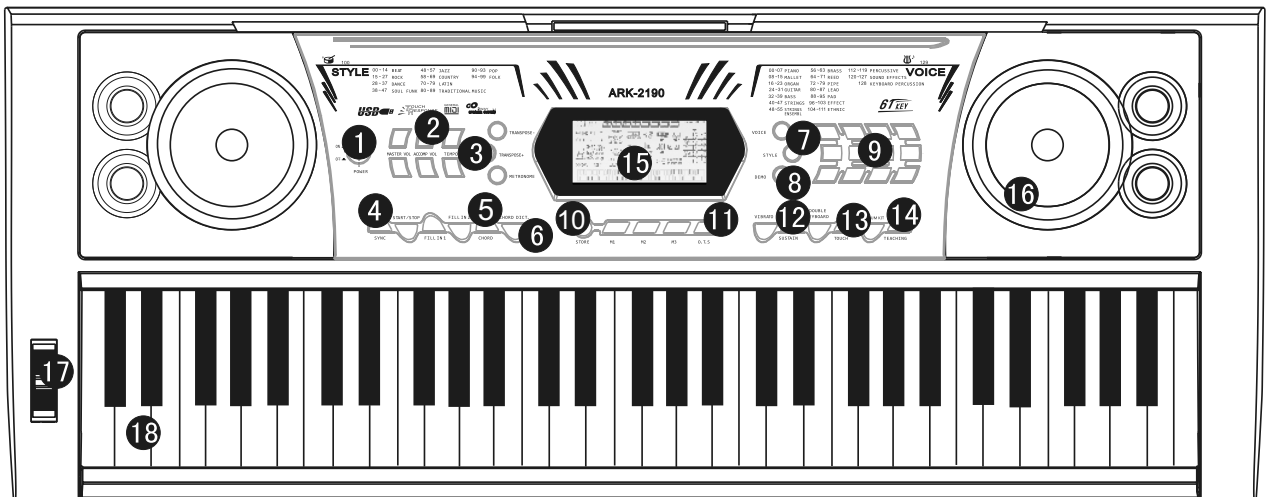

- | | |
|---------------------------------------|-----------------------------------|
| ① Power | ⑩ Store/M1/M2/M3 |
| ② Master vol/accomp vol/tempo | ⑪ O.T.S |
| ③ Transpose+/transpose-/metronome | ⑫ Vibrato/sustain/double keyboard |
| ④ Sync/start/stop/fill in 1/fill in 2 | ⑬ Touch/Drum kit |
| ⑤ Chord | ⑭ Teaching |
| ⑥ Chord DICT. | ⑮ LCD |
| ⑦ Voice/style | ⑯ Loud speaker |
| ⑧ Demo | ⑰ Pitch bend |
| ⑨ Numeric keypad 0~9/+, -button | ⑱ Keyboard |

External function

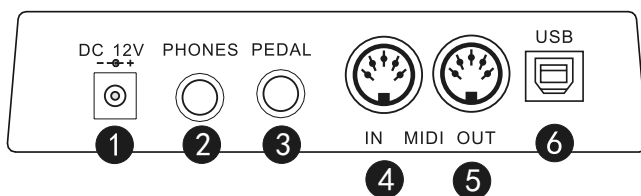

- | |
|----------------------|
| ① DC12V power jack |
| ② Headphone jack |
| ③ Sustain pedal jack |
| ④ MIDI IN jack |
| ⑤ MIDI OUT jack |
| ⑥ USB jack |

Preparation before performance

1. Use AC/DC power adapter:

Please use the special AC/DC power adapter provided with this electronic keyboard or the power adapter with DC 12V voltage and 500mA out current and with central anode. Connect the DC plug of power adapter into the DC12V power socket in the rear of electronic organ. then connect the other end into main socket (see that the input voltage of power adapter conform to the voltage of electric supply), finally turn on power switch and start performance.

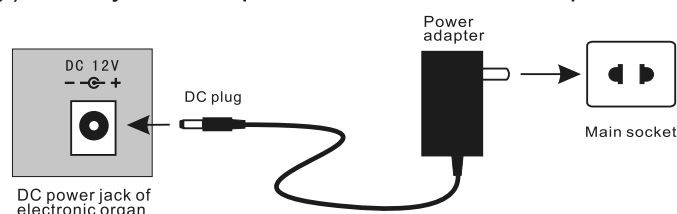

Preparation before performance

Caution: When you do not use this electronic keyboard for a long term, you should pull out the plug of power adapter from main socket safely to avoid possible causing trouble of part or other accident in longterm charging.

2. Use of Batteries

Open the battery lid in the bottom of electronic keyboard and load eight 1.5V Size D batteries, Ensuring the polarity should conform to the direction marked on battery lid. Replace the lid after loading batteries.

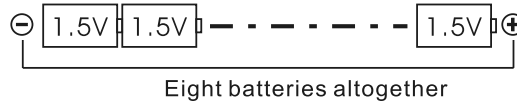

Caution: Do not use batteries of different kinds and mix new and old batteries. Low batteries will cause low volume or poor timbre and replace batteries at that time. To avoid possible damage caused by battery liquid leakage, please take out batteries if you will not use the electronic keyboard for a long term.

Fitting Jack

1. Use of headphone:

Connect headphone plug into "HEADPHONE" jack in the rear of electronic keyboard. now the internal speakers are automatically switched off. Use of headphone in performedoes not interfere with anybody else, suiting personal monitor and exercising at night.

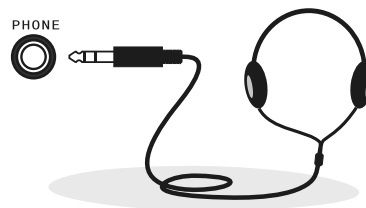

2. Pedal function

When using pedal to perform, it can keep elegant and prolonging sound effect even after fingers leaving the keys.

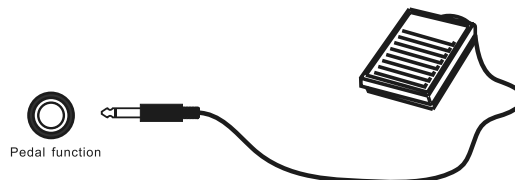

3. USB function

Take one end of USB cable to connect with computer USB jack, other end to connect with electronic keyboard USB jack then the performing data of electronic keyboard can be transmitted to the computer or computer music file data can be transmitted to electronic keyboard.

To use of USB data transmission function, consumer need to complete following operation:

1. make use of standard USB cable to connect with computer USB jack and electronic keyboard USB jack.
2. Install related USB MIDI music software in computer.

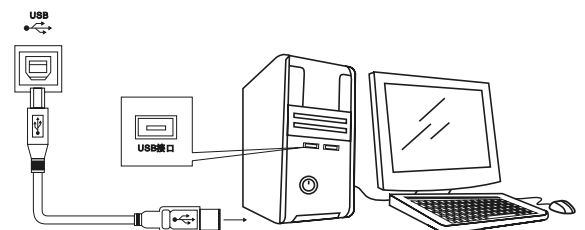

Caution: These external facilities do not include in this keyboard unit, consumer have to buy it respectively

Preparation before performance

4. Jack of MIDI IN/OUT:

1. MIDI IN: By linking MIDI tie line, you may connect MIDI-IN jack to another MIDI-compatible device to receive MIDI data from external MIDI device.

2. MIDI OUT: By linking MIDI tie line, you may connect MIDI-OUT jack to another MIDI-compatible device to transfer MIDI data of the electronic organ. When you perform a note, the corresponding MIDI data will be transferred. You can also control other MIDI devices by transferring program changing data.

III. Basic Operation

1. Turn on power switch:

After connecting AC adapter or installing batteries properly, press POWER button to turn on the electronic keyboard. To turn it off, Press the button once again.

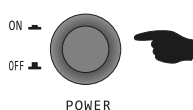

2. Adjustment of Volume:

This electronic keyboard has 32 levels "VOLUME", from 00 to 31 for your choice. The default value of the master volume is 31, press [MASTER VOLUME] +/- button, the master volume has the corresponding increase or decrease. The LCD volume displaying has the corresponding change as well. If you press the [MASTER VOLUME] +/- button at the same time. The volume will recover to the default value automatically.

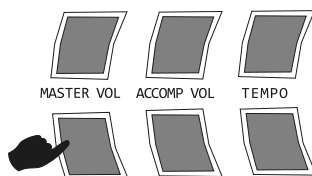

3. Accompaniment Volume Adjustment:

The default "ACCOMPANIMENT VOLUME" is 28 and can be adjusted by pressing volume +/- buttons. During adjustment, LCD gives correspondent display. Accompaniment volume can be adjusted within the scope of 00 to 31.

Press volume +/- buttons simultaneously to restore default setting of accompaniment volume automatically.

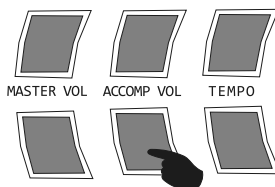

4. Tempo

1. Press "Tempo" +/- buttons to adjust the playing tempo of rhythm in the scope of 40-240.

2. Press and hold the "Tempo" +/- buttons to have a continuous tempo adjustment.

3. Press "Tempo" +/- at the same time to restore to the default value.

4. Choose the style when style stop, tempo is automatically set to be the preset value for current style.

If switch to new style while style is playing, tempo will not return to preset value.

III. Basic Operation

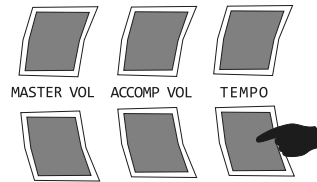

5. Transpose

Press "TRANPOSE" + or - button you can lift or lower the pitch of the electronic keyboard and all together ± 6 levels, press transpose + and - keys Simultaneously to restore the default value "00" automatically. Please note, in the mode of demo song, the function is invalid.

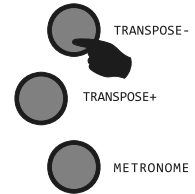

6. Metronome

1. press [metronome], metronome will play as per current tempo. it has 3 kind of beats via pressing +/- button to adjust. default beat is 04, and beat symbol in LCD will flicker in turn, the tempo of the metronome can be adjusted, press [Metronome] to close metronome function.

2. When the style is playing, start [metronome], the beats of the metronome will follow current style beats

Sound selection

It total has 129 kind of voice, including 7 group folk music, 1 group of drum kit

1. the default voice number is 00, LCD display VOICE1, press [+]/[-] or numerical button to chose the voice you need.

2. you can input the number of the voice you need via directly pressing [0]-[9]; or directly press [+]/[-] button for cycle selection, press and hold button will increase or reduce sequence number

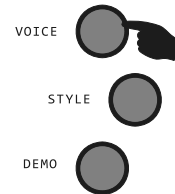

STYLE SELECTION AND PLAY

1. Style selection

1. The default value of the style is 00, press [Style] button to enter to style state, its symbol in LCD will light up and display its sequence number. press [0]-[9] button to input the style sequence number you need; or press [+]/[-] button for cycle choice, press and hold the button will increase or reduce sequence number.

2. when start the style, you can select a new style at any time, its symbol will display in LCD right away. if change the style at first beat, it will respond the new style; if change at other beat, new style will respond at next beat; new style will play at the tempo of original style.

3. 90-99 is piano style, start piano style and press chord again, press left 19 keys of keyboard to start piano chord accompaniment.

2. Style play

Press [start/stop] button to play drum section of style right away; if the chord in open mode, you will hear other voice part of auto accompaniment when press valid chord after style playing such as bass, string music, broken chord .etc.



III. Basic Operation

3. Sync

Press "SYNC" button to start sync accompaniment function. If in the mode of chord closed, It can play any key to start the style accompaniment. If in the mode of chord open, only press any key of 19 keys in left hand (the available auto bass chord area) to start auto chord accompaniment synchronously.

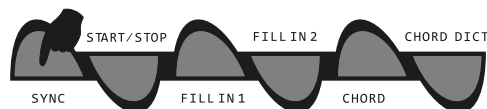

4. Fill-in:

You may press "FILL-IN 1" or "FILL-IN 2" button to insert a fill-in during rhythm play to enhance the performance of effect, then restore to normal rhythm.

Press [start/stop] button to stop rhythm play during FILL-IN performance.

5. Chord:

1. press "CHORD" button to enter into "CHORD" mode and auto chord function open. LCD will display its symbol. press chord button again to exit chord function, state of symbol extinguish.

2. if play with auto accompaniment function when chord function stop, you just hear accompaniment section, if play with auto accompaniment function when in the status of chord function open, and after you press valid chord, you will hear new chord already replaced by the previous chord.

3. Apply single chord and finger chord of multiplex chord mode, all that conform to the fingered chord performance method, the keyboard will respond fingered chord. all that unconform to the fingered chord performance method will respond by single chord (see appendix table: chord type)

6. Chord dictionary

1. press chord dictionary button to enter chord dictionary mode, LCD display "DICT", the keyboard in right hand areas can define chord root and chord type (default chord is major chord). when user chose corresponding chord root and chord type, keyboard in LCD will display accordingly, user can play the chord at left hand area as per LCD display.

2. press "chord Dictionary" again to exit chord status, pls see appendix picture for corresponding chord type and root.

3. Explanation: play right hand area keys to define chord root and chord type, keyboard will not emit. Play right chord at left area will emit a sound of hand clap which means it correctly.

Play wrong chord will emit bass sound of corresponding key. chord that exceed split point will not display will not emit sound.

SOUND EFFECT

1. Sustain

1. the default setting of keyboard is closed

2. Press "sustain" button to switch sustain function on/off, sustain symbol in LCD will light on or off

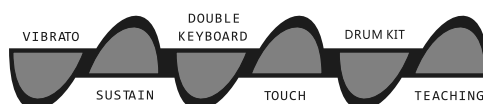

III. Basic Operation

2. Vibrato :

Press "VIBRATO" button to start vibrato function. Now performance with B/W keys automatically produce vibrato effect, Press "VIBRATO" button once again to exit the function.

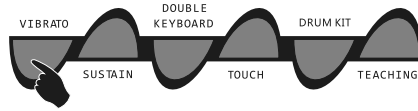

3. Double keyboard

Press "double keyboard" button to enter "double keyboard" function. it split into two separated keyboard start from the 24th key in the left, You can adjust the voice in right keyboard by pressing the numerical 0-9 button. press "double keyboard" button again to exit the function.

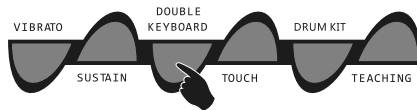

4. Pitch Bend

When you push "PITCH BEND" wheel during performance, the note emitted from keyboard will produce an effect of pitch bend. the pitch variation range is + 2 semitones.

By pushing the wheel upwards to make note higher, and downwards to make note lower. Loosen the wheel to restore original standard tone.

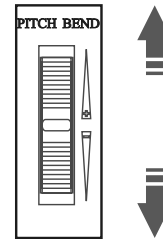

5. Touch

This electronic keyboard is touch keyboard. At startup, touch function will be started automatically. Press "TOUCH" key to cancel touch function and keyboard touch will disappear. Press "TOUCH" key once again to restart touch function.

LCD has it corresponding display symbol for "touch" and without touch.

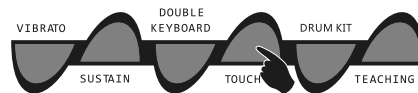

6. DRUM KIT

Press [DRUM KIT] the whole keyboard keys turn to drum kits, each note corresponding to one drum kit (total 61 key drum kits) press [DRUM KIT] again to return to previous sound

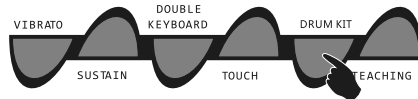

DEMO TEACHING

Teaching mode

1. Press [start/stop] button when in the mode of demo, then press [teaching] to choose function of TEACHING1, TEACHING2, TEACHING3 in cycle or exit teaching function. LCD will display corresponding symbol of the teaching based on different choice, press [start/stop] button to start learning, press [demo] button to exit teaching

2. Teaching 1: aim at learning demo song, no requirement with the pitch correctness demo song play accompaniment section and main melody will be displayed in LCD stave and keyboard area. when user play main melody, it will score for right duration played, and keyboard will emit corresponding sound.

III. Basic Operation

3. Teaching2:

Aim at learning the demo song's main melody pitch, you can learn as per keys display in LCD keyboard, if play the right note, demo will go ahead playing, otherwise, demo song will be in the state of waiting .

4. Teaching3:

Aim at having a comprehensive learning of demo song's duration and main melody .when demo song play accompaniment section , notation and keyboard area in LCD will display main melody, users will not score until play the right pitch and duration .

Evaluating function: all teaching1, teaching2, teaching3 have the 4 grades of evaluating function . when you finish playing, the evaluation function will reduce scores for wrong or missed performance and playing correspondingly sound effect as per your performance level

The First grade: 80-100 scores, play "excellent" effect sound .

The second grade: 60-79 scores ,play" very good "effect sound.

The third grade: 30-59 scores, play " good" effect sound.

The fourth grade: less than 30 scores, play "ok" effect sound.

After finishing evaluating function ,It will automatically restart playing current song and keep the previous learning mode

Demo song

1. It total has 80 demo songs from 00-79, each demo has the function of learning
2. Press demo songs , chose the song by pressing [+][-] button or numerical button
3. the LCD display songs sequence number, current song begin to play in big cycle of 80 demos. press [start/stop] button to stop playing but do not exit song state.
4. play and stop of small cycle of demo song. when big cycle of demos' play stop, press [start/stop] button again to cycle the playing of current song, press again to stop playing but do not exit the song state. to once again enter big cycle of demo songs playing, It must again press the [demo song] to exit song state, then go into song state for the preparation of teaching.

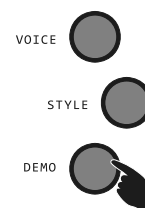

Memory bank

1. It has 3 memory bank (M1-M3) which can store and recall 3 groups of function state and can use flexibly at any times.
2. Press and hold [store] button and press M1 (or M2-M3) simultaneously, it can store current voice, styles, tempo, accompaniment volume, sustain on/off, value of transpose, value of metronome and chord in M1, M2, M3. When performance , just press any memory bank to invoke content of the memory bank .



O.T.S [Single key setting function]

1. O.T.S function can automatically chose sound that fit for current style, each style has 3 sets of C sound.

2. In the mode of O.T.S , corresponding symbol in LCD and M1 symbol light simultaneously , at this time ,press [M1]-[M3] button to call out 3 groups of sound under current style preseting . Corresponding symbol in LCD light up to automatically enter to O.T.S function.

3. press [O.T.S], relevant Memory bank symbol extinguish.

Appendix I. Table of Voice

NO.	NAME OF VOICE	NO.	NAME OF VOICE	NO.	NAME OF VOICE	NO.	NAME OF VOICE
00	Acoustic Grand Piano	34	Electric Bass (pick)	68	Oboe	102	FX 7 (echoes)
01	Bright Acoustic Piano	35	Fretless Bass	69	English Horn	103	FX 8 (sci-fi)
02	Electric Grand Piano	36	Slap Bass 1	70	Bassoon	104	Sitar
03	Honky-tonk Piano	37	Slap Bass 2	71	Clarinet	105	Banjo
04	Rhodes Piano	38	Synth Bass 1	72	Piccolo	106	Shamisen
05	Chorused Piano	39	Synth Bass 2	73	Flute	107	Koto
06	Harpsichord	40	Violin	74	Recorder	108	Kalimba
07	Clavichord	41	Viola	75	Pan Flute	109	Bagpipe
08	Celesta	42	Cello	76	Bottle Blow	110	Fiddle
09	Glockenspiel	43	Contrabass	77	Shakuhachi	111	Shanai
10	Music box	44	Tremolo Strings	78	Whistle	112	Tinkle Bell
11	Vibraphone	45	Pizzicato Strings	79	Ocarina	113	Agogo
12	Marimba	46	Orchestral Harp	80	Lead 1 (square)	114	Steel Drums
13	Xylophone	47	Timpani	81	Lead 2 (sawtooth)	115	Woodblock
14	Tubular Bells	48	String Ensemble 1	82	Lead 3 (calliope lead)	116	Taiko Drum
15	Dulcimer	49	String Ensemble 2	83	Lead 4 (chiff lead)	117	Melodic Tom
16	Hammond Organ	50	Synth Strings 1	84	Lead 5 (charang)	118	Synth Drum
17	Percussive Organ	51	Synth Strings 2	85	Lead 6 (voice)	119	Reverse Cymbal
18	Rock Organ	52	Choir Aahs	86	Lead 7 (fifths)	120	Guitar Fret Noise
19	Church Organ	53	Voice Oohs	87	Lead 8 (bass+lead)	121	FX1
20	Reed Organ	54	Synth Voice	88	Pad 1 (new age)	122	FX2
21	Accordion	55	Orchestra Hit	89	Pad 2 (warm)	123	FX3
22	Harmonica	56	Trumpet	90	Pad 3 (polysynth)	124	FX4
23	Tango Accordion	57	Trombone	91	Pad 4 (choir)	125	FX5
24	Acoustic Guitar (nylon)	58	Tuba	92	Pad 5 (bowed)	126	FX6
25	Acoustic Guitar (steel)	59	Muted Trumpet	93	Pad 6 (metallic)	127	FX7
26	Electric Guitar (jazz)	60	French Horn	94	Pad 7 (halo)	128	Standard kit
27	Electric Guitar (clean)	61	Brass Section	95	Pad 8 (sweep)		
28	Electric Guitar (muted)	62	Synth Brass 1	96	FX 1 (rain)		
29	Overdriven Guitar	63	Synth Brass 2	97	FX 2 (soundtrack)		
30	Distortion Guitar	64	Soprano Sax	98	FX 3 (crystal)		
31	Guitar Harmonics	65	Alto Sax	99	FX 4 (atmosphere)		
32	Acoustic Bass	66	Tenor Sax	100	FX 5 (brightness)		
33	Electric Bass(finger)	67	Baritone Sax	101	FX 6 (goblins)		

Appendix II. Table of Style

NO.	NAME OF STYLE	NO.	NAME OF STYLE	NO.	NAME OF STYLE	NO.	NAME OF STYLE
	BEAT	32	House 1	64	Country Waltz	96	Twist
00	8 beat 1	33	House 2	65	Country Shuffle	97	March
01	8 beat 2	34	Rap	66	Country Boogie	98	6/8 March
02	8 beat 3	35	Euro Beat	67	Country Blues	99	Waltz
03	8 beat 4	36	Hip Hop	68	Country Quick Step		
04	60s 8 beat	37	Techno	69	Bluegrass		
05	8 beat Ballad		SOUL&FUNK		LATIN		
06	8 beat Rock	38	Funky Pop	70	Bossa Nova 1		
07	16 beat 1	39	Jazz Funk	71	Bossa Nova 2		
08	16 beat 2	40	Cool Funky	72	Rhumba		
09	16 beat Pop	41	Soul 1	73	Pop Rhumba		
10	16 beat Shuffle	42	Soul 2	74	Cha Cha		
11	Ballad	43	Soul Shuffle	75	Pop Cha Cha		
12	Slow Ballad	44	Soul Blues	76	Tango		
13	16 beat Ballad	45	R&B	77	Jazz Samba		
14	Unplugged	46	6/8 Gospel	78	Reggae		
	Rock	47	Pop Groove	79	Pop Reggae		
15	Rock		Jazz		TRADITIONAL		
16	Pop Rock	48	Swing	80	March 1		
17	Fast Rock	49	Cool Jazz	81	March 2		
18	Slow Rock 1	50	Pop Swing	82	German March		
19	Slow Rock 2	51	Swing Fox	83	6/8 March		
20	Rock & Roll	52	Big Band	84	Polka		
21	Heavy Metal	53	Big Band Meduim	85	Pop Polka		
22	Blues Boogie	54	Jazz Waltz	86	Waltz		
23	Blues	55	Ragtime	87	Slow Waltz		
24	Shuffle	56	Dixeland	88	Vienna Waltz		
25	Blues Shuffle	57	Quick Step	89	Musette		
26	Rock Shuffle		COUNTRY		PIANO		
27	Charlston	58	Country 1	90	8 beat		
	DANCE	59	Country 2	91	Ballad		
28	Disco 1	60	Pop Country	92	Boogie		
29	Disco 2	61	Country Rock	93	Jazz		
30	Disco Funk	62	Country Folk	94	Swing		
31	Dance	63	3/4 Country	95	Jazz Walta		

Appendix III. Table of Demo Song

NO.	CODE OF SONG	NO.	CODE OF SONG	NO.	CODE OF SONG
	Favorite	33	Waltz Of Starlight	65	FourSwan
00	Heipenposlein	34	Home On The Range	66	Did You Ever See a Lassie
01	Nocturne	35	The Blue-Bells Of Scotland	67	Spring
02	In The Rain	36	Annie Laurie	68	Impromptu
03	Dance De Mirlitons	37	Trumpet	69	Gavotte
04	Air On The G-String	38	Country	70	Nocturne
05	Canon	39	Jambalaya	71	Pizzicato Polka
06	The Red Sarafan	40	Bridge	72	Musical Moments
07	The Light	41	Sippin'Cider Through A Straw	73	Reggae
08	The Old Gray Mare		JAZZ & FUSION	74	All Kind Of My Everything
09	The Entertainer	42	June Samba	75	Valse No.6 "Petit Chien"
10	Lover' s Concerto	43	Guitar&Saxphone	76	Rondeau
11	American Patrol	44	The Hip Hop's Night	77	Chrysanf
12	Chant sans paroles	45	Blue Lunch	78	Invention a 2 Voix
13	Old Folks At Home	46	Cobweb	79	Jesus, Saviour Pilot me
14	Rondo	47	Wine		
15	Water Music	48	Jazz Old Man		
16	Sonata	49	Carlos		
17	o Sole Mio		Christmas		
18	Allegro In bB	50	Ave Maria		
19	Beautiful Dreamer	51	Joy To The World		
20	It'S Been A Long, Long Time	52	Santa Claus Is Coming To Town		
21	Five Hundred Miles	53	Silent Night		
22	Jeanie With The Light Brown Hair	54	Amazing Grace		
23	Summer Palace	55	Susanna		
24	Love Is Blue	56	Battle Hymne Of The Republic		
	FOLK & COUNTRY	57	Carry Me Back To Old Virginny		
25	Danny Boy	58	Turkey In The Straw		
26	My Bonnie	59	Dark Eyes		
27	Skip To My Side		PIANO		
28	Katyusha	60	Fur Elise		
29	Red River Valley	61	Bagatelle No. 3		
30	The Sideway	62	Moseta Dance		
31	Dance Of Russia	63	Prelude in G		
32	House Of Rising Sun	64	Turkish Rondo		

Appendix IV. Table of Chord

NO.	Chord Name/[Abbreviation]	Normal Voicing	Chord(C)	Display
0	Major[M]	1-3-5	C	C
1	Major sixth [6]	1-(3)-5-6	C6	C6
2	Major seventh[M7]	1-(3)-5-7	CM7	CM7
3	Major add ninth[Madd9]	1-2-3-5	Cmadd9	Cmadd9
4	Augmented [aug]	1-3-#5	Cadd9	Cadd9
5	Minor [m]	1-b3-5	Cm	Cm
6	Minor sixth[m6]	1-b3-5-6	Cm6	Cm6
7	Minor seventh[m7]	1-b3-(5)-b7	Cm7	Cm7
8	Minor seventh flatted fifth [m7b5]	1-b3-b5-b7	Cm7b5	Cm7b5
9	Minor major ninth[mM7]	1-b3-(5)-7	CmM7	CmM7
10	Diminished[dim]	1-b3-b5	Cdim	Cdim
11	Diminished seventh [dim7]	1-b3-b5-6	Cdim7	Cdim7
12	Seventh [7]	1-3-(5)-b7	C7	C7
13	Seventh suspended fourth [7sus4]	1-4-5-b7	C7sus4	C7sus4
14	Seventh thirteenth[7 13]	1- 3-(5)-6-b7 or 2-3-5-6-b7	C7 13	C7 13
15	Suspended fourth [sus4]	1-4-5	Csus4	Csus4

Appendix V. Technical Specifications

■ Standard

- GB/T12105-1998 GB 8898-2001 GB13837-2003 GB17625. 1-2003
-

■ Display

- LCD display
-

■ Voice

- 129 Voice
-

■ Style

- 100 selected auto accompaniments, 90-99 are the piano accompaniments
-

■ Demo song

- 80 demo songs, each demo have the function of learning .
-

■ Effect control

- Touch, Sustain, Vibrato, Transpose, Pitch Bend , Tempo , Percussion, Metronome, Double Keyboard
-

■ Record

- STORE , M1, M2, M3, O.T.S
-

■ Teaching

- 3 kind of Learning mode, can score the practice results , facilitate you learning and practice .
-

■ Accompaniment control

- Start/Stop, Sync, Fill-in1, Fill-in2,
-

■ Chord control

- Chord, Chord DICT.
-

■ Other controls

- Master Volume, Accompaniment volume, Tempo
-

■ External port

- DC 12V power jack, Head phone, PEDAL, MIDI IN/OUT, USB
-

■ Diapason

- C2~C7
-

■ Accuracy in musical tuning

- ≤ 3 cent
-

■ Specifications

- 990X420X180(mm)
-

■ Weight

- 5.5Kg
-

■ DC input

- DC12V
-

■ Output power

- 6W×2
-

■ Quiescent current

- 200mA
-

■ Parts provided with electronic organ

- AC/DC adapter, music stand and Operation Instructions
-

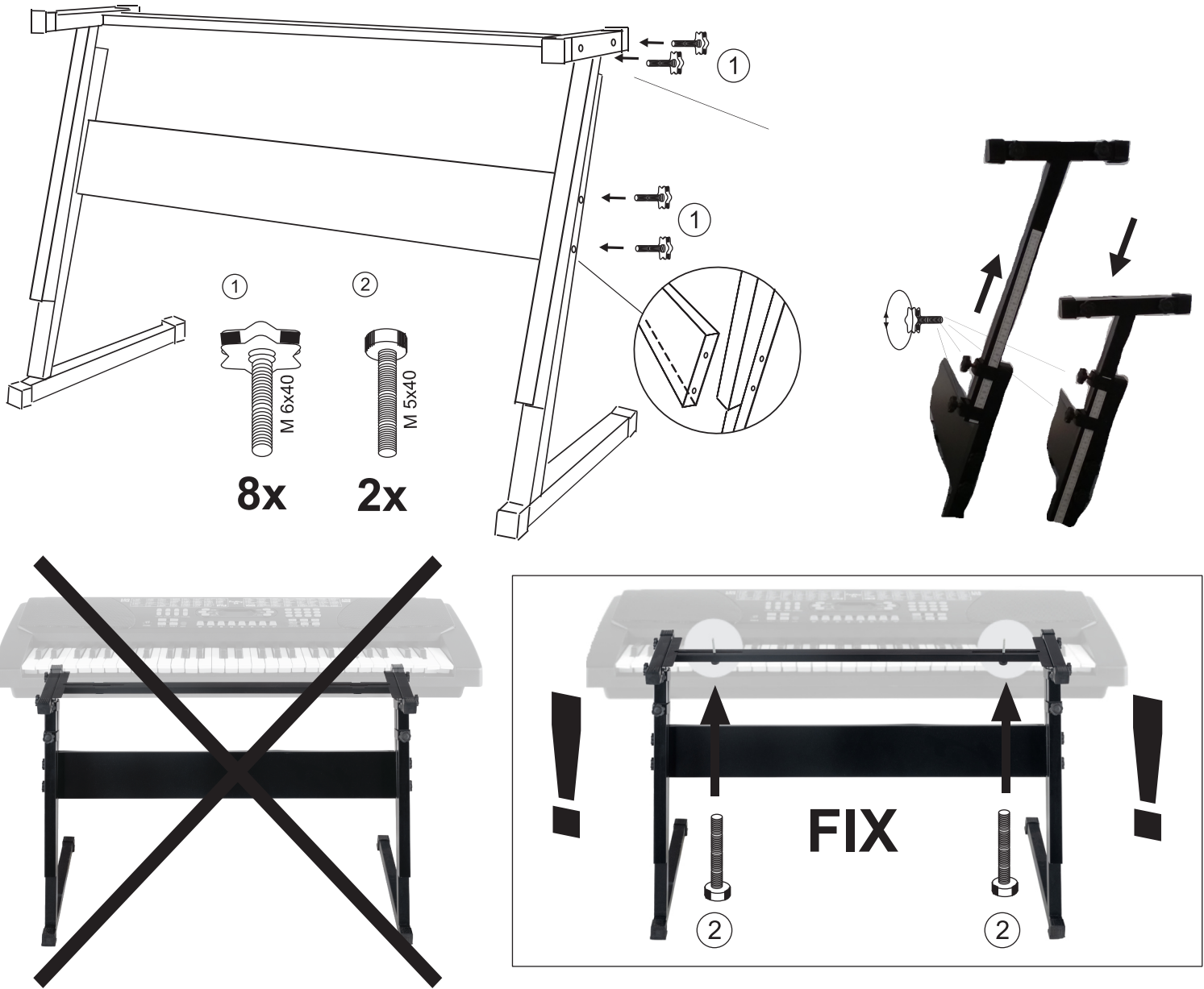

VORSICHTSMASSNAHMEN (BITTE SORGFÄLTIG DURCHLESEN) Kinder sollten beaufsichtigt werden, um sicherzustellen, dass sie dieses Produkt nicht als Spielzeug verwenden. Lassen Sie Kinder niemals unbeaufsichtigt mit dem Verpackungsmaterial spielen. Warnhinweise: Stellen Sie das Produkt stets auf eine geeignete Oberfläche ab, um ein Wackeln oder Umfallen zu verhindern. Vorsichtsmaßnahmen: Um Schäden am Produkt zu vermeiden, stellen Sie es nicht an Plätze mit hohen Temperaturen oder viel Staub, stellen Sie es nicht direkt neben eine Klimaanlage und vermeiden Sie direkte Sonneneinstrahlung. Wenden Sie im Umgang mit dem Produkt keinerlei Gewalt an und stellen Sie keine zu schweren Gegenstände darauf. Ort: Setzen Sie das Produkt nicht den folgenden Bedingungen aus, um Verformungen, Verfärbungen oder größere Schäden zu vermeiden: Direktes Sonnenlicht, extreme Temperatur oder Luftfeuchtigkeit, übermäßig staubiger oder schmutziger Ort, starke Vibrationen oder Stöße. Reinigung: Reinigen Sie das Produkt nur mit einem weichen, trockenen Tuch. Verwenden Sie keine Farbverdünner, Lösungsmittel, Reinigungsflüssigkeiten oder chemisch imprägnierte Wischtücher. Handhabung: Üben Sie keine übermäßige Kraft auf Bedienelemente wie z.B. Schalter, Knöpfe, Tasten aus. Technische Änderungen und Änderungen im Erscheinungsbild sind vorbehalten. Alle Angaben entsprechen dem Stand bei Drucklegung. Für die Richtigkeit und Vollständigkeit der enthaltenen Beschreibungen, Abbildungen und Angaben übernimmt Musikhaus Kirstein GmbH keinerlei Gewähr. Abgebildete Farben und Spezifikationen können geringfügig vom Produkt abweichen. Musikhaus Kirstein GmbH - Produkte sind nur über autorisierte Händler erhältlich. Distributoren und Händler sind keine Handlungsbevollmächtigten von Musikhaus Kirstein GmbH und haben keinerlei Befugnis, die Musikhaus Kirstein GmbH in irgendeiner Weise, sei es ausdrücklich oder durch schlüssiges Handeln, rechtlich zu binden. Diese Bedienungsanleitung ist urheberrechtlich geschützt. Jede Vervielfältigung, bzw. jeder Nachdruck, auch auszugsweise, und jede Wiedergabe der Abbildungen, auch in verändertem Zustand, ist nur mit schriftlicher Zustimmung der Firma Musikhaus Kirstein GmbH gestattet.

PRECAUTIONS (PLEASE READ CAREFULLY) Children should be supervised to ensure that they do not use this product as a toy. Never let children play with the packaging material unsupervised. Warning: Always place the product on a suitable surface to prevent it from wobbling or falling over. Precautions: To avoid damage to the product, do not place it in places with high temperatures or a lot of dust, do not place it directly next to an air conditioner and avoid direct sunlight. Do not use force when handling the product and do not place objects that are too heavy on it. Location Do not expose the product to the following conditions to avoid warping, discoloration, or major damage: direct sunlight, extreme temperature or humidity, excessively dusty or dirty location, strong vibration or shock. Cleaning: Only clean the product with a soft, dry cloth. Do not use paint thinners, solvents, cleaning fluids, or chemically impregnated wipes. Handling: Do not exert excessive force on controls such as Switches, buttons, buttons off. Technical changes and changes in appearance are reserved. All information corresponds to the status at the time of printing. Musikhaus Kirstein GmbH assumes no liability for the correctness and completeness of the descriptions, illustrations and information contained. Shown colors and specifications may differ slightly from the product. Musikhaus Kirstein GmbH - Products are only available through authorized dealers. Distributors and dealers are not authorized representatives of Musikhaus Kirstein GmbH and have no authority to bind Musikhaus Kirstein GmbH legally in any way, be it expressly or through coherent action. This manual is protected by copyright. Any duplication or reprint, even in part, and any reproduction of the images, even in a modified state, is only permitted with the written consent of Musikhaus Kirstein GmbH.