



XDrum Drum Stool Semi

ArtNo. : 00006432



Assembly instructions

Version: 05.2021

© 2021

These operating instructions are protected by copyright. Reproduction of these operating instructions, even in part, is only permitted with the permission of Musikhaus KIRSTEIN GmbH. The same applies to the reproduction or copying of images, even in modified form.

Detailed safety instructions:

- Read these instructions.
- Keep these instructions in a safe place.
- Heed all warnings. Follow all instructions.
- Clean the unit only with a dry cloth.
- Do not install near any heat sources such as radiators, heat registers, stoves, or other apparatus that produce heat.
- Contact qualified service personnel for all repair/maintenance work.

Thank you for choosing this product.

To ensure that you are fully satisfied with this drum stool, please read carefully and understand these assembly instructions before using our product. Keep these assembly instructions in a safe place. The assembly instructions must be passed on to all subsequent users.



Follow the operating instructions!



The signal word **WARNING** indicates hazards that can lead to serious injuries if no precautionary measures are taken.



The signal word **NOTE** indicates general precautions that should be observed when handling the product.



Images and screen representations in these assembly instructions may differ slightly from the appearance of the actual product, as long as this does not have a negative impact on the technical properties and safety of the product.



All person-related formulations in these assembly instructions are to be regarded as gender-neutral.

These assembly instructions apply to persons who have been supervised or instructed in the operation of the product by a person responsible for their safety and who have demonstrated their ability to handle the product.



**Children should be supervised to ensure that they do not play with the product.
Do not leave children unattended.**

All information in these assembly instructions has been checked to the best of our knowledge and belief. However, neither the author nor the publisher can be held liable for any damage in connection with the use of these assembly instructions.

Other product, brand and company names mentioned in this document may be the trademarks of their respective owners. Compliance with all applicable copyright laws is the responsibility of the user of this document.

Assembly of your XDrum drum stool:



(Fig.1)

Unfold the tripod and secure it for a firm stand with the lower wing screw. (Fig. 1)



(Fig. 2)

Insert the rod, which you will later use for height adjustment, into the three-legged stand and now use the wing screw to fix the desired seat height of the stool. (Fig.2)



(Fig. 3)

Finally, you can attach the seat to the top of the bar and fix it with a wing screw. The seat position is now height-adjustable from 50 cm to 62 cm. (Fig. 3)

**WEEE Declaration
(Waste of Electrical and Electronic Equipment)**

Your product has been designed and manufactured using high quality materials and components that are recyclable and reusable. The symbol means that your product must be disposed of separately from household waste at the end of its life. Dispose of this appliance at your local collection point or recycling centre. Please help protect the environment in which we all live.

All technical data and appearances are subject to change without notice. All information was correct at the time of going to press. Musikhaus Kirstein GmbH does not guarantee the accuracy or completeness of the descriptions, photographs or statements contained in this manual. Printed colours and specifications may differ slightly from the product. Musikhaus Kirstein GmbH products are only sold through authorised distributors. Distributors and dealers are not representatives of Musikhaus Kirstein GmbH and are not authorised to legally bind Musikhaus Kirstein GmbH in any way.

 KIRSTEIN.de

**Kirstein Music House GmbH
Bernbeurener Str. 11
86956 Schongau - Germany
Phone: 0049-8861-909494-0
Fax / Fax: 0049-8861-909494-19**



Classic Cantabile AP-30 Active Monitor

ArtNo. : 00011178



Operating instructions

Version: 02.2021

© 2021

These operating instructions are protected by copyright. Reproduction of these operating instructions, even in part, is only permitted with the permission of Musikhaus Kirstein GmbH. The same applies to the reproduction or copying of images, even in modified form.

Content

| | |
|--|----------|
| Detailed safety instructions: | 2 |
| Using the Active Monitor | 3 |
| Controls: | 4 |
| Connections: | 5 |
| WEEE Declaration (Waste of Electrical and Electronic Equipment) | 6 |

Thank you for purchasing this Classic Cantabile Active Monitor.
To ensure that you are completely satisfied with the item, please read carefully and understand this owner's manual before using our product. Keep these operating instructions in a safe place. The operating instructions must be passed on to all subsequent users.



Follow the operating instructions!



The signal word **WARNING** indicates hazards that can lead to serious injuries if no precautionary measures are taken.



The signal word **NOTE** indicates general precautions to be observed when handling the product.



Images and screen representations in these operating instructions may differ slightly from the appearance of the actual product, as long as this does not have a negative impact on the technical characteristics and safety of the product.



All person-related formulations in these operating instructions are to be regarded as gender-neutral.

These operating instructions apply to persons who have been supervised or instructed in the operation of the appliance by a person responsible for their safety and who have demonstrated their ability to handle the appliance.



**Children should be supervised to ensure that they do not play with the appliance.
Do not leave children unattended.**

All information in these operating instructions has been checked to the best of our knowledge and belief. However, neither the author nor the publisher can be held liable for any damage in connection with the use of these operating instructions.

Other product, brand and company names mentioned in this document may be the trademarks of their respective owners. Compliance with all applicable copyright laws is the responsibility of the user of this document.

Detailed safety instructions:

- Read these instructions.
- Keep these instructions in a safe place.
- Heed all warnings. Follow all instructions.
- Do not use this appliance near water.
- Clean the unit only with a dry cloth.
- Do not block any ventilation openings.
- Do not install near any heat sources such as radiators, heat registers, stoves, or other apparatus that produce heat.
- Do not step on the cable and avoid pinching it, especially at the cable plug, the socket and the cable exit from the appliance.
- Use only stands, tripods, brackets or tables specified by the manufacturer or sold with the unit. Handle with care to avoid injury.
- Pay attention to the volume! Listening at too high a volume level can permanently damage your hearing.
- Disconnect this unit from the power supply during thunderstorms or when not in use for long periods of time.
- Contact qualified service personnel for all repair/maintenance work. Do not open the unit or the housing without authorisation. Servicing is required when the apparatus has been damaged in any way, such as power-supply cord or plug is damaged, liquid has been spilled or objects have fallen into the apparatus, the apparatus has been exposed to rain or moisture, does not operate normally, or has been dropped.

Specifications:

Power supply: AC 120V~, 60 Hz

Power: 40W

Weight: 15kg

Dimensions: 351x345x367mm

Use of the Active Monitor

Installation place

Do not expose your device to the following conditions to avoid deformation, discolouration or more serious damage:

- Direct sunlight
- Too high temperatures (near a heat source or in a car exposed to direct sunlight).
- Humidity

Operation and transport

Do not apply excessive force to the rotary joints, connections or other parts of the box for use.

Always pull the cables out of the socket by the plug and not by pulling on the cable. Disconnect the cables from all sockets before moving the product.

Dropping the unit, bumping it or placing heavy objects on it may result in damage to the unit. In this case, scratches or other more serious damage may also occur.

Electronic noise

This product contains digital circuitry and may occasionally interfere with radio or television equipment if placed too close to it. If such interference occurs, move the speaker further away from the affected equipment.

Cleaning

Clean the instrument with a dry, lint-free cloth. A slightly damp cloth can remove stubborn dirt from the instrument.

Do not use chemical cleaning agents containing alcohol or thinner.

Do not place vinyl objects on the unit.

Switch off the unit before connecting it to the power supply

To avoid damage to your unit and connected instruments, switch off all connected equipment before connecting or disconnecting power.

Energy supply

Switch the "Power" button to "OFF" when you are not using the unit.

Controls:

Front

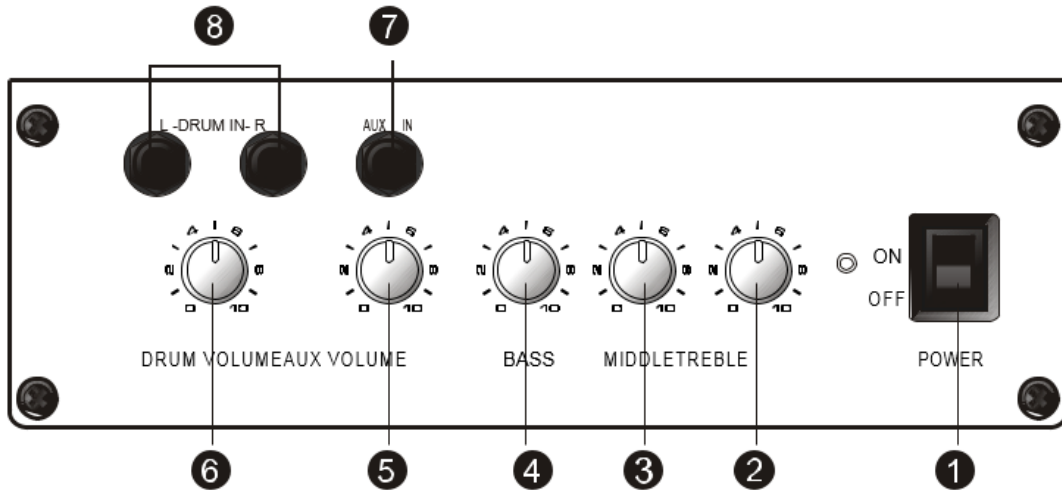

1. "Power" button - Switch the unit on or off
2. "Treble" knob - Allows you to adjust the treble in the mix
3. "Middle" knob - Regulate the mids in the mix
4. "Bass" knob - This can be used to raise or lower the bass in the mix
5. AUX Volume Knob - Use this knob to adjust the output volume of the external audio signal.
6. "Drum Volume" knob - Use this knob to regulate the output volume of the connected instrument.
7. AUX IN socket - input socket for connecting external audio equipment
8. Drum IN socket (left and right) - input socket for digital instruments such as e-drums

Back cover

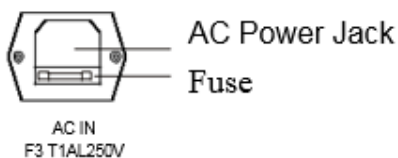

If the power supply does not match the requirements of the amplifier, the electrical fuse may be damaged.

If the amplifier does not operate normally, have this fuse checked.

Connections:

Connecting the power cable

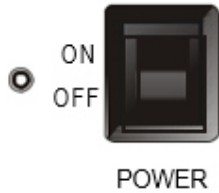

Make sure that the amplifier is switched off while connecting or disconnecting the unit from the power source.

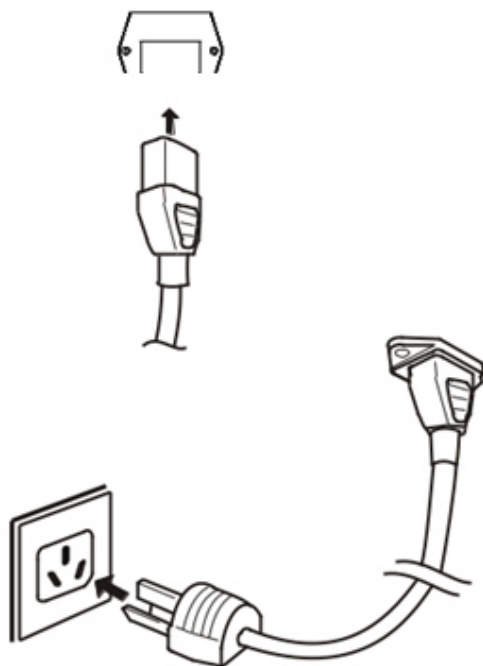

Connect the power cable to the power input socket on the back of the box.

Plug the power cable into the socket.

Connecting the Drum IN socket

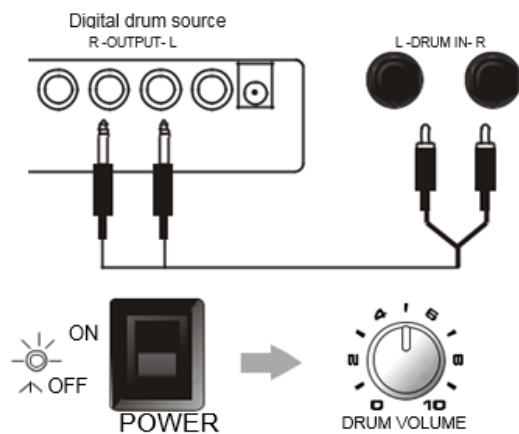

Connect your digital drum set via audio cable to the Drum IN socket of the amplifier while it is switched off.

The volume of the digital drum set can be changed by the "Drum Volume" control.

AUX IN socket

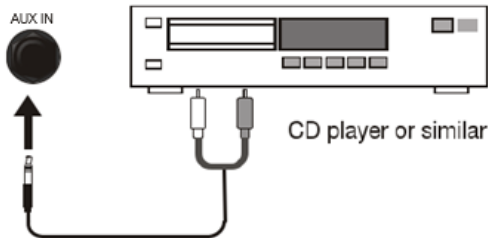

Connect your external audio device (e.g. MP3 player, mobile phone, etc.) to the AUX IN socket to play your favourite songs parallel to the drum kit sound.



The volume of the external audio device can be changed using the AUX volume control.

WEEE Declaration (Waste of Electrical and Electronic Equipment)

Your product has been designed and manufactured using high quality materials and components that are recyclable and reusable. The symbol means that your product must be disposed of separately from household waste at the end of its life. Dispose of this appliance at your local collection point or recycling centre. Please help protect the environment in which we all live.

All technical data and appearances are subject to change without notice. All information was correct at the time of going to press. Musikhaus Kirstein GmbH does not guarantee the accuracy or completeness of the descriptions, photographs or statements contained in this manual. Printed colours and specifications may differ slightly from the product. Musikhaus Kirstein GmbH products are only sold through authorised distributors. Distributors and dealers are not representatives of Musikhaus Kirstein GmbH and are not authorised to legally bind Musikhaus Kirstein GmbH in any way.

 **KIRSTEIN.de**

Musikhaus Kirstein GmbH
Bernbeurener Str. 11
86956 Schongau - Germany
Phone: 0049-8861-909494-0
Fax / Fax: 0049-8861-909494-19





00073463 - XDrum DD-460P Mesh E-Drum Kit
00073464 - XDrum DD-460C Mesh E-Drum Kit



Operating instructions

Revision: 07-2021

© 2020

These operating instructions are protected by copyright. Reproduction of these operating instructions, even in part, is only permitted with the permission of Musikhaus Kirstein GmbH. The same applies to the reproduction or copying of images, even in modified form.

Content

| | |
|---|-----------|
| Safety precautions and precautionary measures..... | 3 |
| Important information..... | 4 |
| Structure and functions | 5 |
| Installation instructions | 6 |
| Module..... | 9 |
| Basic settings and operation | 10 |
| Advanced settings..... | 13 |
| WEEE Declaration..... | 16 |

Thank you for choosing this product.

To ensure that you are completely satisfied with this product, please read these operating instructions carefully before using our product. Keep these operating instructions in a safe place. The operating instructions must be passed on to all subsequent users.



Follow the operating instructions!



The signal word **WARNING** indicates hazards that can lead to serious injuries if no precautionary measures are taken.



The signal word **NOTE** indicates general precautions that should be observed when handling the product.



Images and screen representations in these operating instructions may differ slightly from the appearance of the actual product, as long as this does not have a negative impact on the technical characteristics and safety of the product.



All person-related formulations in these operating instructions are to be regarded as gender-neutral.

All information in these operating instructions has been checked to the best of our knowledge and belief. However, neither the author nor the publisher can be held liable for any damage in connection with the use of these operating instructions.

Other product, brand and company names mentioned in this document may be the trademarks of their respective owners. Compliance with all applicable copyright laws is the responsibility of the user of this document.

Safety precautions and precautionary measures



Always place the appliance securely on a level surface to avoid injury from the appliance falling over.



Do not place any devices that can heat up (e.g. lighting equipment or fog machines) on the unit.



Never touch the mains cable or the unit when it is wet, as this may cause an electronic shock.

Do not clean the plastic housing with solvents or other chemical-based cleaning agents.

Keep the unit away from rain and moisture.

Damage caused by non-compliance with this user manual is not covered by the warranty. The dealer accepts no liability for any resulting defects or problems.

Before connecting, make sure that the mains cable is in perfect condition.

Only touch the mains cable by the plug.

Always plug in the mains plug last. Plugging in must be done without using force.

Avoid contact of the mains cable with other cables.

Do not bend or twist the cable and do not place any objects on it.

This unit can damage your hearing if the volume is too high. If you experience hearing problems or ringing in your ears, consult a specialist immediately.

Make sure that no objects or liquids of any kind get into the unit.

Protect the unit from hard impacts.

Disconnect the unit from the mains during thunderstorms.

Switch off the unit immediately and unplug the mains adapter from the socket if:

- The power supply unit, the power cable or the plug is damaged
- Smoke or unusual odour occurs
- Objects have fallen into the unit or liquid has been spilled on the unit.
- The unit has been exposed to moisture
- The unit does not function properly or there is a significant change in performance

Important information

Power supply

- Do not plug the appliance into the same sockets as other electrical appliances controlled by an inverter (e.g. freezer, washing machine, microwave or air conditioner) or containing a motor. Depending on how the electrical appliance is used, disturbances in the power supply may cause malfunctions and/or produce audible noises.
- Before connecting the unit to other devices, all devices must be disconnected from the mains. This prevents malfunctions and/or damage to speakers or other devices.

Placement

- Using the E-Drum near amplifiers (or other equipment with large power transformers) may cause a hum. To correct the problem, change the orientation of the unit or place it further away from the source of interference.
- This unit may interfere with radio and television reception. Therefore, do not use this unit in the vicinity of such receivers.
- Noise can be caused by wireless communication devices, such as mobile phones, being used in the vicinity. Such noise may occur when receiving or initiating a call or during a conversation. If you experience such problems, you should place the wireless devices so that they are at a greater distance from the e-drum or turn them off.
- Do not expose the unit to direct sunlight, place it near heat-emitting devices, leave it in a closed vehicle or otherwise expose it to extreme temperatures. Excessive heat may deform, discolour or damage the unit.

Maintenance

- For daily cleaning, wipe the unit with a soft, dry cloth or a cloth slightly moistened with water.
- As sound vibrations can be transmitted through floors and walls more than expected. Be careful that these sounds do not become a nuisance to neighbours, especially at night and when using headphones.

Structure and functions



- 1. Drum module**
- 2. Hi-Hat Cymbal**
- 3. Crash Cymbal**
- 4. Tom 1 Pad**
- 5. Tom 2 Pad**
- 6. Ride Cymbal**
- 7. Tom 3 Pad**
- 8. Snare Pad**
- 9. Foot machine**
- 10. Hi-Hat Controller**

Installation instructions

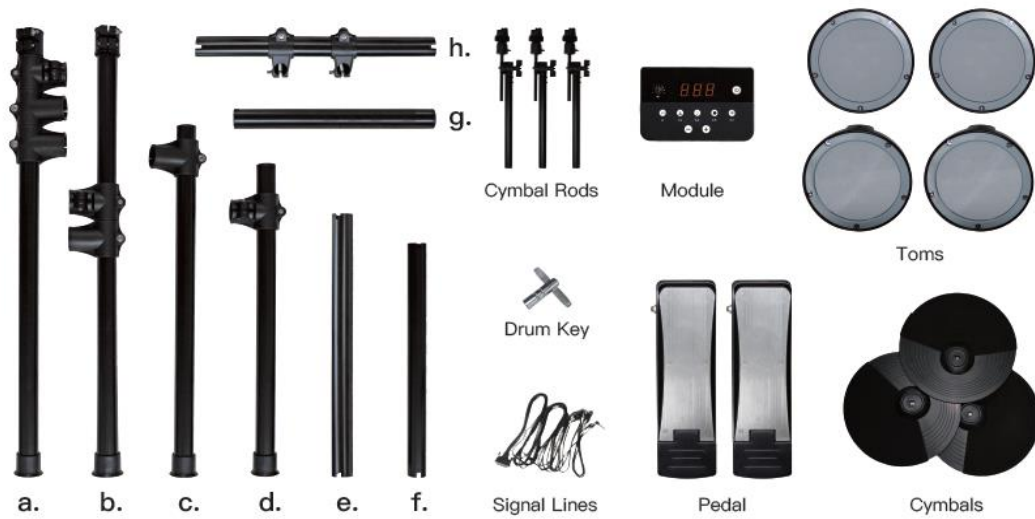

Workflow:

- Open the packaging with a knife and remove all components. Compare the components with the parts list above.
- Assemble the components as described in the pictures below and then screw them tight.



1. Install the toms on the tubes e und f

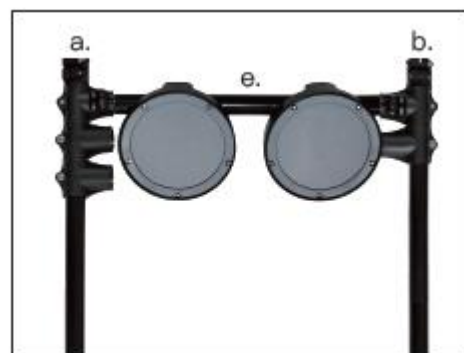

2. Connect the tubes a und b with the tube e

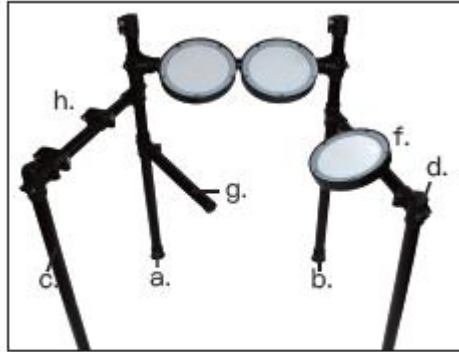

3. Connect the other tubes like above



Note: When assembling the tubes, make sure that the rack has reached position 1 shown and then tighten the screw at position 2 with the tuning key

- Mounting the cymbal pads on the cymbal arms

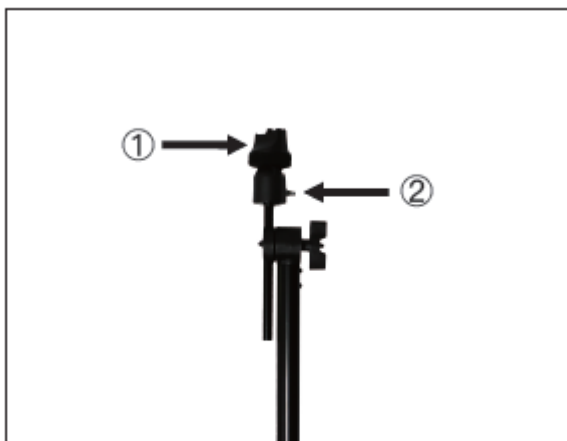

1. Remove the cymbal cap and fasten the screw on the cymbal arm



2. Place the cymbal pad on the cymbal arm



3. Align the cymbal pads so that the groove lines up with the stand. Then fix it with the cymbal cap.

- Attach the tom to the frame g.

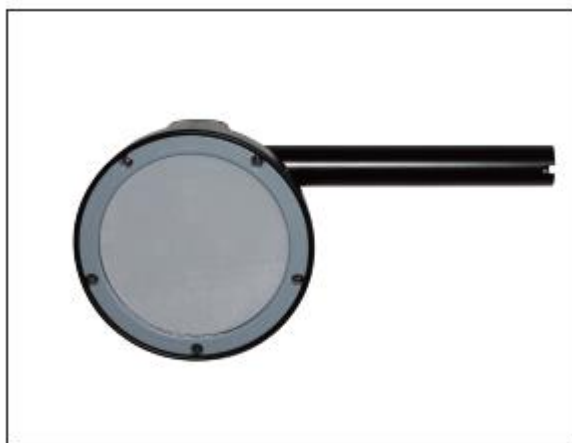

1. Step



2. Step

- You can now place the pedals on the floor and connect the cymbal pads and toms to the module via cable.

Module

Top and bottom

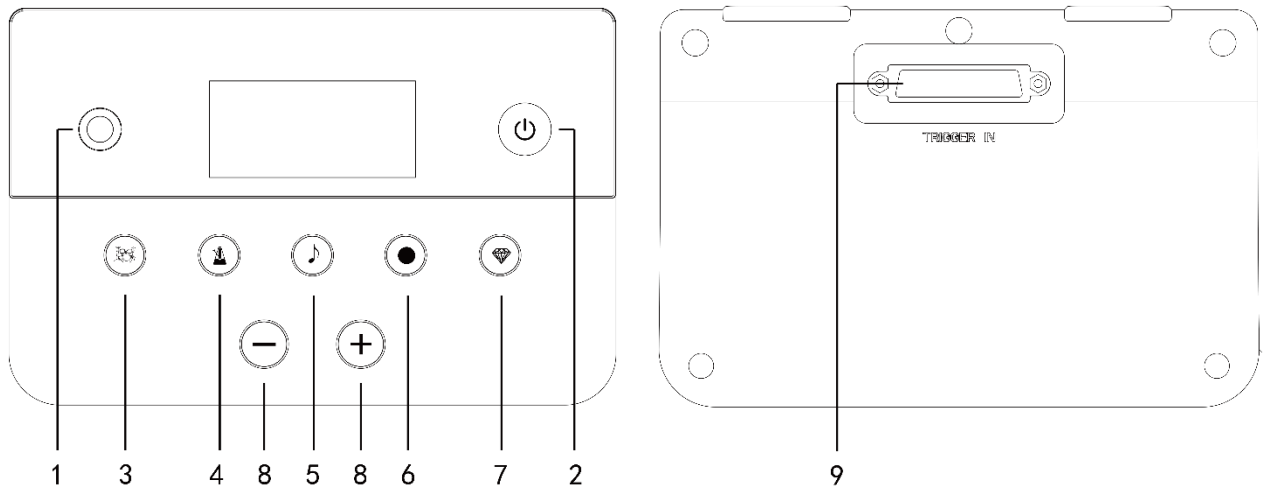

- 1) Volume control: For adjusting the volume
- 2) On/Off button: Switch the unit on or off
- 3) DRUM button: Press this button and then use the [+] / [-] buttons to select the different drum kits.
- 4) Click button: Press this button to change the tempo of the metronome with the buttons [+] / [-].
- 5) Song button: Press this button and then use the [+] / [-] buttons to select a song.
- 6) REC button: Press these buttons to record your play
- 7) Multi key: The multi key has different functions.
Short press = start/stop the metronome/song/playback of a recording
Long press = advanced settings
- 8) [+] / [-] buttons: Press these buttons to switch drum kits, metronome tempo selection, song selection, etc.
- 9) Trigger connection: Connect the multicore cable of all components to the module here.

Back cover

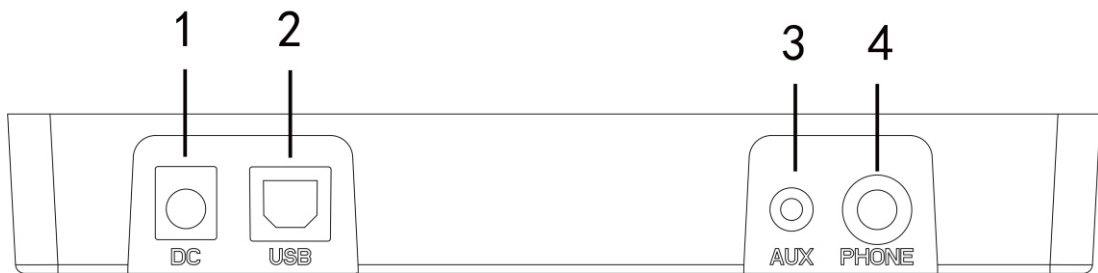

- 1) DC IN socket: Connect the supplied power supply unit here to supply the e-drum with power.
- 2) USB socket: Use this socket to connect your e-drum to a PC/laptop/etc. via USB cable, so that you can use midi functions.
- 3) AUX socket: Use of an external audio device e.g. smartphone, iPad/tablet and MP3, e.g. to play along with your own songs.
- 4) Phone jack: Connect your headphones here to hear the sound of the e-drums. Alternatively, you can connect an external speaker box to amplify the sound of the e-drums.

Basic settings and operation

4.1) Drum Kit Mode

- Press the DRUM button to enter drum kit mode



The DRUM button light is on. P01 is the default drum kit mode

- Use [+] / [-] to select between the different drum kits (P01-P25)
- Press the MULTI button to start the metronome
The light of the CLICK button flashes according to the metronome
- Press the MULTI button again to stop the metronome
The light of the CLICK button stops flashing

4.2) CLICK mode

- Press the CLICK button to switch to CLICK mode



The light of the CLICK button lights up

- Use the [+] / [-] keys to select the tempo
- The possible tempo range is between 20 - 300
- Press the MULTI key to start the metronome
The light of the CLICK button flashes according to the metronome
- Press the MULTI button to stop the metronome
The light of the CLICK button lights up again

4.3) SONG mode

- Press the SONG button to switch to SONG mode.



The light of the SONG button lights up.

- Use the [+] / [-] keys to select a song
- Press the MULTI button to play a song
- Press the MULTI button again to stop the song
The MULTI button lights up while a song is playing and goes out as soon as the song is stopped.

TIP:

- When playing a song, the tempo of the song can be adjusted by changing the tempo of the metronome
- When you switch between songs, the tempo of the metronome follows the tempo changes of the songs

4.4) Recording mode (REC button)

- Press the REC button to switch to recording mode.



The REC button light comes on, the metronome starts automatically and you are ready to record.

- Hit a pad to start recording
- Press the REC button to stop recording
Now the screen shows the tempo
- Press the MULTI button to play the recording
- If you press the MULTI button during recording, the recording is stopped and played
- If the screen shows "No" when the MULTI button is pressed, it means that there is no recording file available

TIP:

- If you switch to another function interface after recording, the recording is deleted
- When the maximum number of 5000 notes is reached, the recording is automatically deleted



4.5 Switch off

- (1) Turn the volume of the module and all connected devices to 0
- (2) Press and hold the on/off button until the screen shows "off"
- (3) Now you can release the On/Off button again

Advanced settings

5.1 Setting the volume and trigger parameters

- Press the DRUM button to enter drum kit mode
- Press the MULTI button for more than 2 seconds to enter the PAD volume adjustment setup. Now the light of the DRUM button flashes
- Hit the pad that you want to adjust the volume of. You can change the value with the [+] / [-] keys.
- Press the DRUM button again to switch to the setup for setting the trigger parameters

| Screen | Settings | Value | Description |
|---|-----------------------|---------|---------------------------------------|
|  | Volume | 0 – 127 | The volume of each pad |
|  | Triggering parameters | 0 – 10 | The triggering parameters of each pad |



- Hit the pad that you want to adjust. With the keys [+] / [-] you can set the value
- Press the MULTI button again to save your settings and return to drum mode

The triggering parameters are a combination of sensitivity and anti-cross. The larger the value, the more sensitive the trigger and the smaller the anti-cross (crosstalk between different components when another pad is struck).

5.2 Setting the metronome

The tempo as well as the beat and note values can be changed.

- Press the CLICK button to access the metronome settings
- Press and hold the MULTI button for more than 2 seconds for the metronome setting setup to appear
- Press the CLICK button and switch to the settings you want to change

| Screen | Settings | Value | Description |
|---|----------|--|-------------------------------------|
|  | Bars | b01 - b09 | Setting the bars |
|  | Rhythm | Whole note 1/2 note 1/4 note 1/8 note Eighth note triplet 1/16 note | Setting the note value |
|  | Volume | u01 - u10 | Setting the volume of the metronome |

- Use the [+] / [-] keys to change the desired values
- Press the MULTI button to save the settings and return to the metronome interface

5.3 MIDI-related settings

- Press the SONG button to access the SONG settings
- Press and hold the MULTI button for more than 2 seconds to open the MIDI settings interface
- Strike the pad that you want to adjust. Use the [+] / [-] buttons to edit the MIDI value of the pads (0-127).
- Press the MULTI button again to save the settings and return to the SONG interface

TIP:

- If the MIDI value of the meshhead and the rim shot are the same, the sound of the meshhead will always be heard. Therefore, these two values should be different.

MIDI code default values

| Pads | Key value |
|----------------|-----------|
| Bass Drum | 36 |
| Snare head | 38 |
| Snare Rim Shot | 40 |
| Tom1 Fur | 48 |
| Tom2 Fur | 45 |
| Tom3 Fur | 43 |
| Crash surface | 49 |
| Crash edge | 55 |
| Ride surface | 51 |
| Ride edge | 59 |

| Pads | Key value |
|------------------------------|-----------|
| Hi-Hat surface (open) | 46 |
| Hi-Hat rim (open) | 26 |
| Hi-Hat surface (closed) | 42 |
| Hi-Hat rim (closed) | 22 |
| Hi-Hat Pedal (closed) | 44 |
| Hi-Hat surface (half closed) | 23 |
| Hi-Hat rim (half closed) | 24 |
| Snare X-Stick | 37 |
| Ride bell | 69 |
| Hi-Hat Splash | 99 |

5.4 Restoring the factory settings

- Press and hold the [+] button when the unit is switched off. At the same time, you must press the On/Off button.

Picture 1:



- Release the [+] key as soon as screen 1 appears.

Picture 2:

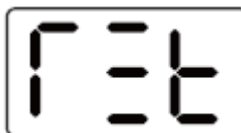

Now the screen shows picture 2 as above.

- Press the MULTI button to restore the factory settings. The screen starts flashing until it has been completely reset to the factory settings. This may take a few seconds.

WEEE Declaration

(Waste of Electrical and Electronic Equipment)

Your product has been designed and manufactured using high quality materials and components that are recyclable and reusable. The symbol means that your product must be disposed of separately from household waste at the end of its life. Dispose of this appliance at your local collection point or recycling centre.

Please help protect the environment in which we all live.

All technical data and appearances are subject to change without notice. All information was correct at the time of going to press. Musikhaus Kirstein GmbH does not guarantee the accuracy or completeness of the descriptions, photographs or statements contained in this manual. Printed colours and specifications may differ slightly from the product. Musikhaus Kirstein GmbH products are only sold through authorised distributors. Distributors and dealers are not representatives of Musikhaus Kirstein GmbH and are not authorised to legally bind Musikhaus Kirstein GmbH in any way.

 **KIRSTEIN.de**

Musikhaus Kirstein GmbH
Bernbeurener Straße 11
86956 Schongau - Germany
Phone: 0049-8861/909494-0
Fax: 0049-8861/909494-19

