



# XDrum Drum Stool Semi

ArtNo. : 00006432



## Assembly instructions

Version: 05.2021

© 2021

These operating instructions are protected by copyright. Reproduction of these operating instructions, even in part, is only permitted with the permission of Musikhaus Kirstein GmbH. The same applies to the reproduction or copying of images, even in modified form.

### **Detailed safety instructions:**

- Read these instructions.
- Keep these instructions in a safe place.
- Heed all warnings. Follow all instructions.
- Clean the unit only with a dry cloth.
- Do not install near any heat sources such as radiators, heat registers, stoves, or other apparatus that produce heat.
- Contact qualified service personnel for all repair/maintenance work.

Thank you for choosing this product.

To ensure that you are fully satisfied with this drum stool, please read carefully and understand these assembly instructions before using our product. Keep these assembly instructions in a safe place. The assembly instructions must be passed on to all subsequent users.



Follow the operating instructions!



The signal word **WARNING** indicates hazards that can lead to serious injuries if no precautionary measures are taken.



The signal word **NOTE** indicates general precautions that should be observed when handling the product.



Images and screen representations in these assembly instructions may differ slightly from the appearance of the actual product, as long as this does not have a negative impact on the technical properties and safety of the product.



All person-related formulations in these assembly instructions are to be regarded as gender-neutral.

These assembly instructions apply to persons who have been supervised or instructed in the operation of the product by a person responsible for their safety and who have demonstrated their ability to handle the product.



**Children should be supervised to ensure that they do not play with the product.  
Do not leave children unattended.**

All information in these assembly instructions has been checked to the best of our knowledge and belief. However, neither the author nor the publisher can be held liable for any damage in connection with the use of these assembly instructions.

Other product, brand and company names mentioned in this document may be the trademarks of their respective owners. Compliance with all applicable copyright laws is the responsibility of the user of this document.

## Assembly of your XDrum drum stool:



(Fig.1)

Unfold the tripod and secure it for a firm stand with the lower wing screw. (Fig. 1)



(Fig. 2)

Insert the rod, which you will later use for height adjustment, into the three-legged stand and now use the wing screw to fix the desired seat height of the stool. (Fig.2)



(Fig. 3)

Finally, you can attach the seat to the top of the bar and fix it with a wing screw. The seat position is now height-adjustable from 50 cm to 62 cm. (Fig. 3)

**WEEE Declaration  
(Waste of Electrical and Electronic Equipment)**

Your product has been designed and manufactured using high quality materials and components that are recyclable and reusable. The symbol means that your product must be disposed of separately from household waste at the end of its life. Dispose of this appliance at your local collection point or recycling centre. Please help protect the environment in which we all live.

All technical data and appearances are subject to change without notice. All information was correct at the time of going to press. Musikhaus Kirstein GmbH does not guarantee the accuracy or completeness of the descriptions, photographs or statements contained in this manual. Printed colours and specifications may differ slightly from the product. Musikhaus Kirstein GmbH products are only sold through authorised distributors. Distributors and dealers are not representatives of Musikhaus Kirstein GmbH and are not authorised to legally bind Musikhaus Kirstein GmbH in any way.

** KIRSTEIN.de**

**Kirstein Music House GmbH  
Bernbeurener Str. 11  
86956 Schongau - Germany  
Phone: 0049-8861-909494-0  
Fax / Fax: 0049-8861-909494-19**



## Classic Cantabile AP-30 Active Monitor

ArtNo. : 00011178



## Operating instructions

Version: 02.2021

© 2021

These operating instructions are protected by copyright. Reproduction of these operating instructions, even in part, is only permitted with the permission of Musikhaus Kirstein GmbH. The same applies to the reproduction or copying of images, even in modified form.

## **Content**

<b>Detailed safety instructions:</b> .....	<b>2</b>
<b>Using the Active Monitor</b> .....	<b>3</b>
<b>Controls:</b> .....	<b>4</b>
<b>Connections:</b> .....	<b>5</b>
<b>WEEE Declaration (Waste of Electrical and Electronic Equipment) .....</b>	<b>6</b>



Thank you for purchasing this Classic Cantabile Active Monitor.  
To ensure that you are completely satisfied with the item, please read carefully and understand this owner's manual before using our product. Keep these operating instructions in a safe place. The operating instructions must be passed on to all subsequent users.



Follow the operating instructions!



The signal word **WARNING** indicates hazards that can lead to serious injuries if no precautionary measures are taken.



The signal word **NOTE** indicates general precautions to be observed when handling the product.



Images and screen representations in these operating instructions may differ slightly from the appearance of the actual product, as long as this does not have a negative impact on the technical characteristics and safety of the product.



All person-related formulations in these operating instructions are to be regarded as gender-neutral.

These operating instructions apply to persons who have been supervised or instructed in the operation of the appliance by a person responsible for their safety and who have demonstrated their ability to handle the appliance.



**Children should be supervised to ensure that they do not play with the appliance.  
Do not leave children unattended.**

All information in these operating instructions has been checked to the best of our knowledge and belief. However, neither the author nor the publisher can be held liable for any damage in connection with the use of these operating instructions.

Other product, brand and company names mentioned in this document may be the trademarks of their respective owners. Compliance with all applicable copyright laws is the responsibility of the user of this document.

---

## Detailed safety instructions:

- Read these instructions.
- Keep these instructions in a safe place.
- Heed all warnings. Follow all instructions.
- Do not use this appliance near water.
- Clean the unit only with a dry cloth.
- Do not block any ventilation openings.
- Do not install near any heat sources such as radiators, heat registers, stoves, or other apparatus that produce heat.
- Do not step on the cable and avoid pinching it, especially at the cable plug, the socket and the cable exit from the appliance.
- Use only stands, tripods, brackets or tables specified by the manufacturer or sold with the unit. Handle with care to avoid injury.
- Pay attention to the volume! Listening at too high a volume level can permanently damage your hearing.
- Disconnect this unit from the power supply during thunderstorms or when not in use for long periods of time.
- Contact qualified service personnel for all repair/maintenance work. Do not open the unit or the housing without authorisation. Servicing is required when the apparatus has been damaged in any way, such as power-supply cord or plug is damaged, liquid has been spilled or objects have fallen into the apparatus, the apparatus has been exposed to rain or moisture, does not operate normally, or has been dropped.

## Specifications:

**Power supply:** AC 120V~, 60 Hz

**Power:** 40W

**Weight:** 15kg

**Dimensions:** 351x345x367mm

---

## Use of the Active Monitor

### Installation place

Do not expose your device to the following conditions to avoid deformation, discolouration or more serious damage:

- Direct sunlight
- Too high temperatures (near a heat source or in a car exposed to direct sunlight).
- Humidity

### Operation and transport

Do not apply excessive force to the rotary joints, connections or other parts of the box for use.

Always pull the cables out of the socket by the plug and not by pulling on the cable. Disconnect the cables from all sockets before moving the product.

Dropping the unit, bumping it or placing heavy objects on it may result in damage to the unit. In this case, scratches or other more serious damage may also occur.

### Electronic noise

This product contains digital circuitry and may occasionally interfere with radio or television equipment if placed too close to it. If such interference occurs, move the speaker further away from the affected equipment.

### Cleaning

Clean the instrument with a dry, lint-free cloth. A slightly damp cloth can remove stubborn dirt from the instrument.

Do not use chemical cleaning agents containing alcohol or thinner.

Do not place vinyl objects on the unit.

### Switch off the unit before connecting it to the power supply

To avoid damage to your unit and connected instruments, switch off all connected equipment before connecting or disconnecting power.

### Energy supply

Switch the "Power" button to "OFF" when you are not using the unit.

**Controls:**

**Front**

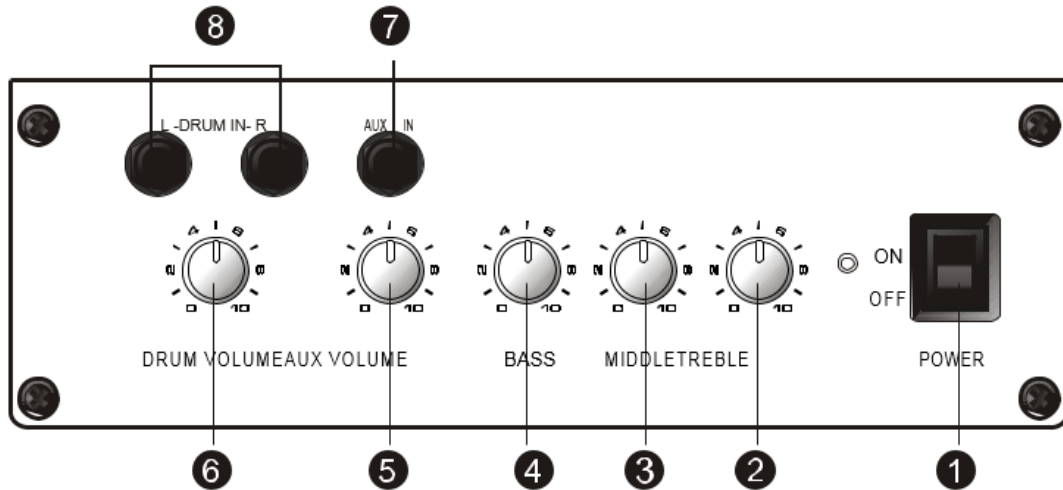

1. "Power" button - Switch the unit on or off
2. "Treble" knob - Allows you to adjust the treble in the mix
3. "Middle" knob - Regulate the mids in the mix
4. "Bass" knob - This can be used to raise or lower the bass in the mix
5. AUX Volume Knob - Use this knob to adjust the output volume of the external audio signal.
6. "Drum Volume" knob - Use this knob to regulate the output volume of the connected instrument.
7. AUX IN socket - input socket for connecting external audio equipment
8. Drum IN socket (left and right) - input socket for digital instruments such as e-drums

**Back cover**

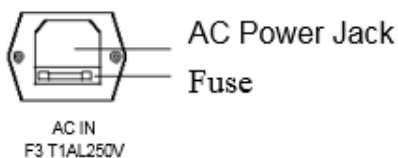

If the power supply does not match the requirements of the amplifier, the electrical fuse may be damaged.

If the amplifier does not operate normally, have this fuse checked.

**Connections:**

**Connecting the power cable**

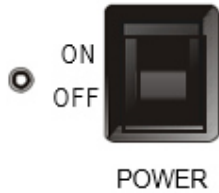

Make sure that the amplifier is switched off while connecting or disconnecting the unit from the power source.

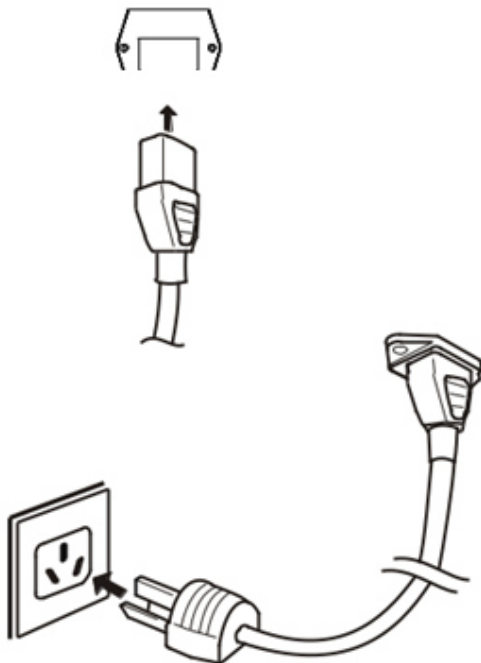

Connect the power cable to the power input socket on the back of the box.

Plug the power cable into the socket.

**Connecting the Drum IN socket**

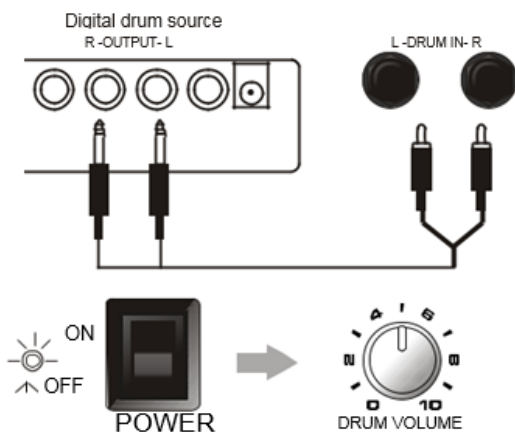

Connect your digital drum set via audio cable to the Drum IN socket of the amplifier while it is switched off.

The volume of the digital drum set can be changed by the "Drum Volume" control.

## AUX IN socket

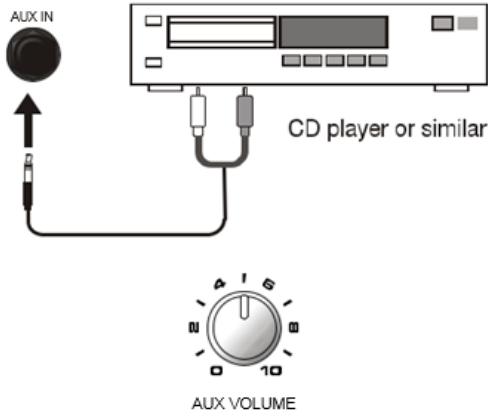

Connect your external audio device (e.g. MP3 player, mobile phone, etc.) to the AUX IN socket to play your favourite songs parallel to the drum kit sound.

The volume of the external audio device can be changed using the AUX volume control.

## WEEE Declaration (Waste of Electrical and Electronic Equipment)

Your product has been designed and manufactured using high quality materials and components that are recyclable and reusable. The symbol means that your product must be disposed of separately from household waste at the end of its life. Dispose of this appliance at your local collection point or recycling centre. Please help protect the environment in which we all live.

All technical data and appearances are subject to change without notice. All information was correct at the time of going to press. Musikhaus Kirstein GmbH does not guarantee the accuracy or completeness of the descriptions, photographs or statements contained in this manual. Printed colours and specifications may differ slightly from the product. Musikhaus Kirstein GmbH products are only sold through authorised distributors. Distributors and dealers are not representatives of Musikhaus Kirstein GmbH and are not authorised to legally bind Musikhaus Kirstein GmbH in any way.

 **KIRSTEIN.de**

**Musikhaus Kirstein GmbH**  
**Bernbeurener Str. 11**  
**86956 Schongau - Germany**  
**Phone: 0049-8861-909494-0**  
**Fax / Fax: 0049-8861-909494-19**





**00073463 - XDrum DD-460P Mesh E-Drum Kit**

**00073464 - XDrum DD-460C Mesh E-Drum Kit**



## Instruction manual

Revision: 04-2023

© 2023

These operating instructions are protected by copyright. The reproduction of these operating instructions, even in part, is only permitted with the approval of Musikhaus Kirstein GmbH. The same applies to the reproduction or copying of images, even in modified form.

## Table of contents

Safety precautions and precautionary measures .....	3
Important information.....	4
Structure and functions.....	5
Installation guide .....	6
Module .....	8
Quick-Start .....	11
Drum Kit Mode .....	11
Metronome mode .....	11
Coach mode.....	12
Loop mode .....	12
Loop recording .....	13
Song mode.....	14
Play to a song .....	14
Menu .....	14
Kit Setting (Settings).....	14
Instrument settings .....	15
PAD settings .....	16
MIDI settings .....	18
Options.....	20
Simplified EU Declaration of Conformity .....	21
WEEE Declaration.....	21



Thank you for choosing this product.  
To ensure that you are completely satisfied with this product, please read this instruction manual carefully before using our product. Keep these operating instructions in a safe place. The operating instructions must be passed on to all subsequent users.



Observe the operating instructions!



The signal word **WARNING** is used to indicate hazards that can lead to serious injuries if no precautionary measures are taken.



The signal word **NOTE** indicates general precautions that should be observed when handling the product.



Images and screen representations in these operating instructions may differ slightly from the appearance of the actual product, as long as this does not have a negative impact on the technical characteristics and safety of the product.



All person-related formulations in these operating instructions are to be regarded as gender-neutral.

All information in this operating manual has been checked to the best of our knowledge and belief. However, neither the author nor the publisher can be held liable for any damage related to the use of these operating instructions.

Other product, brand and company names mentioned in this document may be the trademarks of their respective owners. Compliance with all applicable copyright laws is the responsibility of the user of this document.

## Safety precautions and precautionary measures



Always place the device securely on a level surface to avoid injuries caused by the device falling over.



Do not place any devices that can heat up (e.g. lighting equipment or fog machines) on the device.



Never touch the power cord or the device when it is wet, as this may result in an electronic shock.

Do not clean the plastic housing with solvents or other chemical-based cleaning agents.

Keep the device away from rain and moisture.

Damage resulting from non-observance of this user manual is not covered by the warranty. The dealer accepts no liability for any resulting defects or problems.

Before connecting, make sure that the power cord is in good condition.

Only grasp the power cord by the plug.

Always plug in the power plug last. The plugging in must be done without using force.

Avoid contact of the power cord with other cables.

Do not bend or twist the cable and do not place any objects on it.

This device can damage hearing if the volume is too high. If you notice hearing problems or ringing in your ears, see a specialist immediately.

Make sure that no objects or liquids of any kind get into the device.

Protect the device from hard impacts.

Disconnect the device from the power supply during thunderstorms.

Immediately turn off the power and unplug the AC adapter from the wall outlet if:

- The power supply unit, the power cable or the plug is damaged
- Smoke or unusual odor occurs
- Objects have fallen into the device or liquid has been spilled on the device
- The device has been exposed to moisture
- The device does not function properly or a significant change in performance occurs

## Important information

### Power supply

- Do not plug the device into the same outlets as other electrical equipment controlled by an inverter (e.g. freezer, washing machine, microwave or air conditioner) or containing a motor. Depending on how the electrical appliance is used, disturbances in the power supply may cause malfunctions and/or produce audible noises.
- Before connecting the device to other devices, all devices must be disconnected from the mains. This prevents malfunction and/or damage to speakers or other devices.

### Placement

- Using the E-Drum near amplifiers (or other devices with large power transformers) may cause hum. To correct the problem, change the orientation of the device or place it further away from the source of interference.
- This device may interfere with radio and television reception. Therefore, do not use this device near such receivers.
- Interference noise can be caused by wireless communication devices, such as cell phones, which are used in the immediate vicinity. Such interfering noises can occur when receiving or initiating a call or during a conversation. If you experience such problems, you should place the wireless devices so that they are at a greater distance from the E-Drum or turn them off.
- Do not expose the device to direct sunlight, place it near heat-emitting devices, leave it in a closed vehicle, or otherwise expose it to extreme temperatures. Excessive heat can deform, discolor or damage the device.

### Maintenance

- For daily cleaning, wipe the device with a soft, dry cloth or a cloth slightly moistened with water.
- Since sound vibrations can be transmitted through floors and walls more than expected. Be careful that these sounds do not become a nuisance to neighbors, especially at night and when using headphones.

## Structure and functions



- 1. Drum module**
- 2. Hi-Hat Cymbal**
- 3. Crash cymbal**
- 4. Tom 1 pad**
- 5. Tom 2 Pad**
- 6. Ride cymbal**
- 7. Tom 3 Pad**
- 8. Snare Pad**
- 9. Foot machine**
- 10. Hi-Hat Controller**

## Installation guide

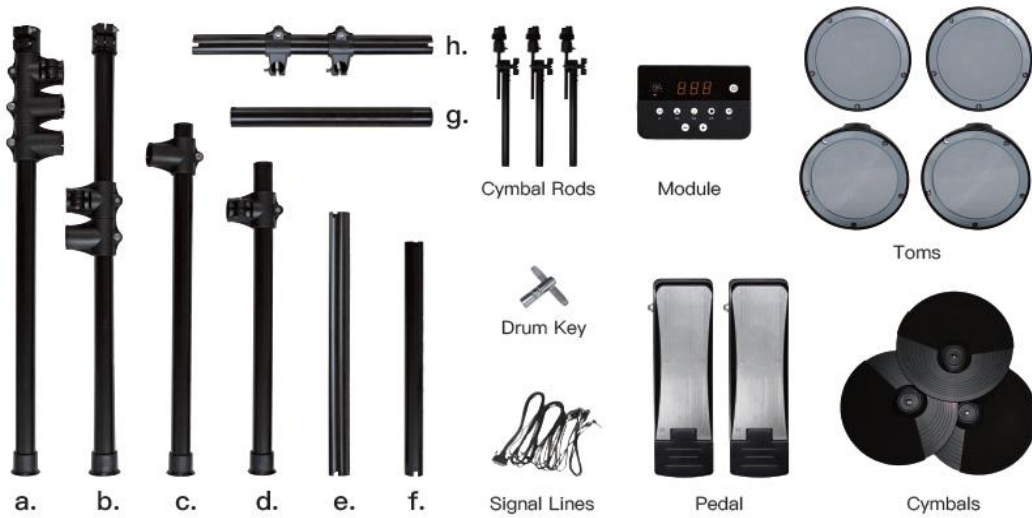

- Open the packaging with a knife and remove all components. Compare the components with the parts list above.
- Assemble the components as described in the pictures below and then screw them tight.



1. Installieren Sie die Toms auf dem Gestell e und f

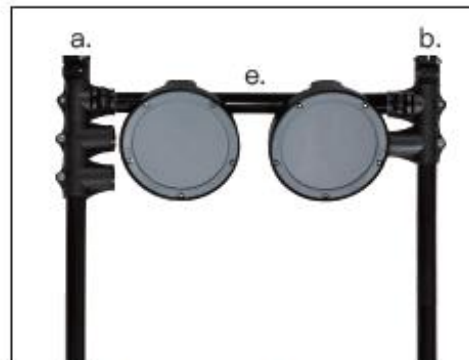

2. Verbinden Sie Gestell a und b durch das Gestell e

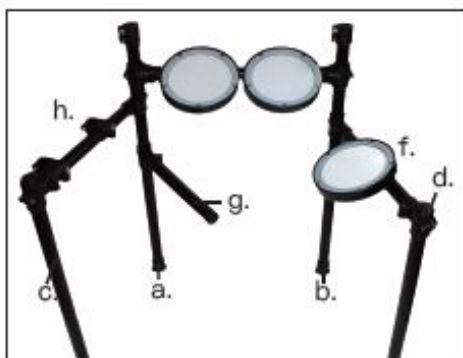

3. Stecken Sie die anderen Gestelle so zusammen



Hinweis: Achten Sie bei der Montage der Trommelgestelle darauf, dass das Gestell die abgebildete Position 1 erreicht hat und ziehen Sie dann die Schraube an Position 2 mit dem Trommelschlüssel fest

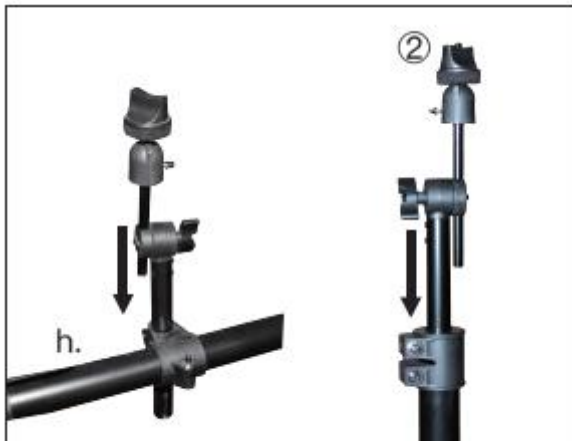

4. Beckenstange in Gestell einstecken



5. Montieren Sie das Modul an dem Gestell

- Mount cymbal pads to cymbal rods

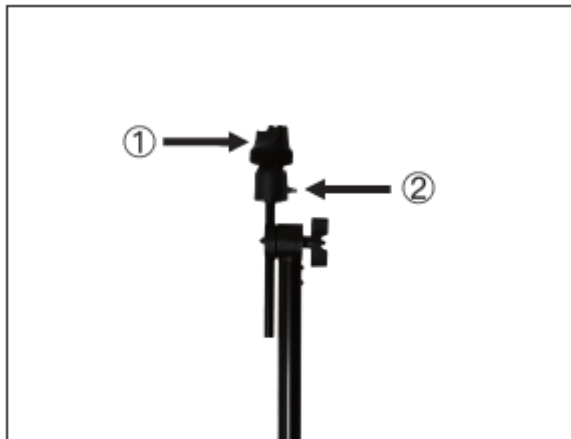

1. Nehmen Sie den Beckenkappe ab und befestigen die Schraube des Ständers



2. Beckenpad auf den Ständer legen



3. Richten Sie die Beckenpads so aus, dass die Rille mit dem Ständer übereinstimmt. Anschließend mit der Beckenkappe fixieren.

- Attach the tom to the rack g.



1. Schritt



2. Schritt

- You can now place the pedals on the floor and connect the cymbal pads, as well as the toms to the module via cable.

## Module

### Front

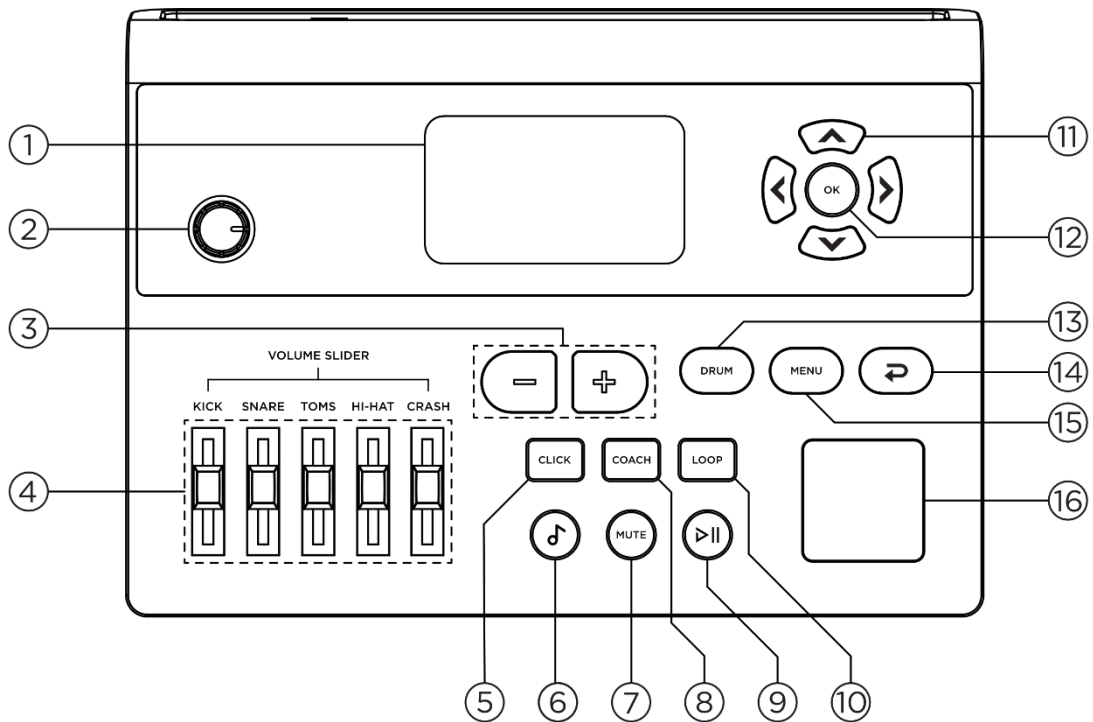



- 1. Display:** For displaying various information.
- 2. Volume control:** To adjust the overall volume.
- 3. +/- buttons:** Press these buttons to switch drum kits, metronome tempo selection, song selection, etc. Pressing the [+] button will increase the value and pressing the [-] button will decrease the value.
- 4. Volume faders:** With these sliders (faders) you can adjust the volumes of the different components to each other.
- 5. CLICK button:** Press this button to activate the metronome. The key illumination flashes as soon as the metronome is active. Long press the [CLICK] button to enter the metronome-setting menu.
- 6. Song button:** Press this button to play a song. Long press this button to enter the song settings.
- 7. Mute button:** During the playback of a song, you can use this button to mute the drum part in the song. The button lights up continuously when the function is on. Press it again to add the drum part again.
- 8. COACH button:** Pressing this button will take you to the Coach function. This allows you to view the timing of your individual strokes on the screen.
- 9. STOP/PLAY button:** Press this button to play or stop a song.
- 10. LOOP button:** Press this key briefly to enter the LOOP menu. Press this key again briefly to play back or stop the recording. The key is lit continuously during recording. The metronome is automatically switched on during recording. Long press to enter the LOOP settings menu.
- 11. Cursors:** Use these keys to move the cursor on the screen.
- 12. OK button:** Press this key to confirm your selection, e.g. to enter submenus.
- 13. DRUM button:** By pressing this button, you can access the start screen of the different drum kits.
- 14. RETURN button:** Press this key to return to the parent/previous menu. Your settings will be saved automatically when you press this key.
- 15. MENU button:** Use this key to enter the main menu.
- 16. PAD:** You can tap this pad with your finger to hear the selected instrument during the sound setting. During the tempo/metronome setting, you can use this key as a tap function to "play in" the desired tempo. When using the Loop function, you can use this button instead of a pad to start recording. Please do not use sticks of any kind to strike this pad.



### Back cover:

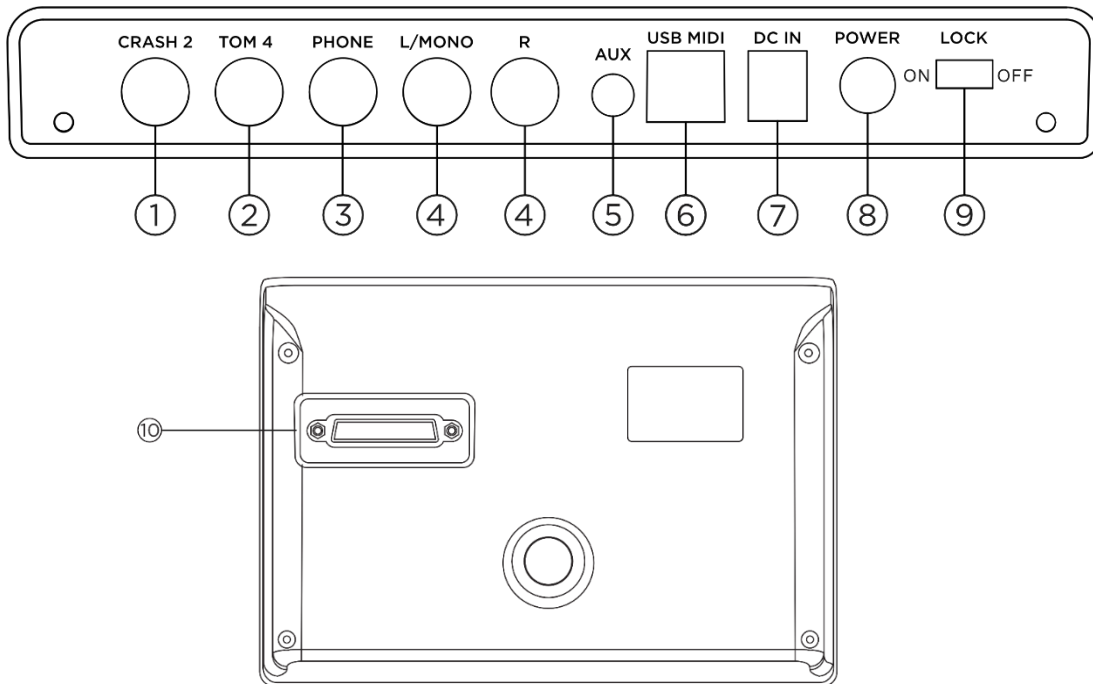

**1. CRASH 2 connector:** Use this jack to connect a second crash cymbal.

**2. TOM 4 connector:** Use this connector to connect a fourth tom pad.

**3. Headphone output:** for connecting stereo headphones.  
When using headphones, the LINE OUT is not muted.

**4. LINE OUT - Mono (L) & Stereo (R):** You can use these outputs to connect your e-drum to an external speaker cabinet to amplify the sound of the e-drum loudly. By connecting two 6.3mm jack cables to both the L/Mono and R jacks, separate left and right audio signals are sent through each channel (stereo). Alternatively, you can use only the left channel (L/Mono) with a 6.3mm jack cable to transmit mono signals.

**5. AUX input:** For connecting an external audio source, such as a cell phone, MP3 or CD player. The sound from this audio source is output from both the L/R jacks and the PHONE jack.

**6. USB MIDI port:** Use this jack to connect your e-drum to a PC/laptop/etc. via USB cable and use midi functions.

**7. DC IN jack:** Connect the supplied power supply here to power the e-drum.

**8. Power switch:** To switch the module on or off.

**9. LOCK:** Turn this switch ON to activate the lock mode. Thus, various parameter settings cannot be changed. If you switch the switch back to OFF, the lock mode is deactivated and the parameter settings can be changed again.

**10. Trigger connector:** Connect the multicore cable of all components to the module here.

## Quick-Start

Connect the power supply and audio equipment (headphones, external speaker) to the module according to the instructions. Now press the [POWER] button on the module to start the device and enter the Start-screen. You can use the [-], [+] buttons to switch to different drum kits. Use the drumsticks to play each pad. After playing, press the [POWER] button again to turn off the unit.

## Drum Kit Mode

Press [DRUM] to go to the Start-screen as shown below. On this page, you can use [+], [-] or [<], [>] to switch between different drum kits.

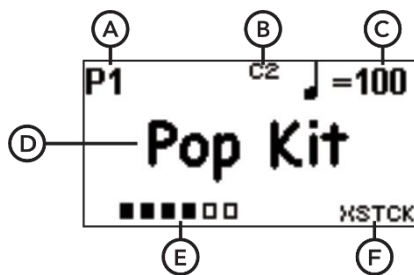

- A. Indicates the number of the current drum kit. P means preset kit and U means user kit.
- B. Indicates the struck pad. For example, the C2 symbol means Crash 2.
- C. Indicates the set tempo. You can use the down and up arrow keys to adjust the tempo. Press [CLICK] briefly to turn the metronome on or off.
- D. Displays the name of the drum kit. The name of user kits (U) must not exceed 13 characters.
- E. Indicates the hardness of the strokes. The greater the force, the more squares are filled black.
- F. Indicates whether the cross-stick function is active. By pressing the OK key, you can activate or deactivate this function. The XSTCK symbol in the figure above indicates that the function is disabled.

## Metronome mode

Press [CLICK] briefly to switch the metronome on or off. When the power is turned on, the key light flashes. Long press [CLICK] to enter the metronome settings (as shown in the figure below). You can also access the metronome settings by pressing the [MENU] button.

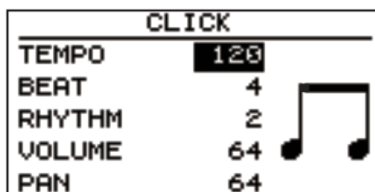

Use up and down arrow keys to select the desired parameters. Use [+], [-] to change the value or type of the selected parameter.

### Tempo

Use [+], [-] to change the value. Press [OK] to enter the TAP mode. Hit any pad four times to have the tempo calculated automatically. The possible setting range is between 20-240 bpm (beats per minute).

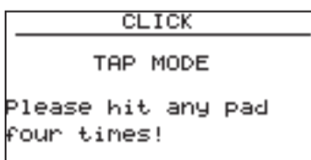

**Beat**

Controls the number of beats per measure. You can choose between 1 and 16.

**Rhythm**

There are seven different rhythm patterns available.

- 1.
- 2.
- 3.
- 4.
- 5.
- 6.
- 7.

**Volume**

Controls the volume of the metronome. Range: 0-127.

**Pan**

Controls the panorama of the metronome. 0 = leftmost, 64 = center, 127 = rightmost. Range: 0-127.

**Sound**

Controls the sound of the metronome. You can choose between five different variants.

**Coach mode**

This activates the Coach function, which allows you to see your timing on the screen. This allows you to train your timing to play the strokes perfectly in time.

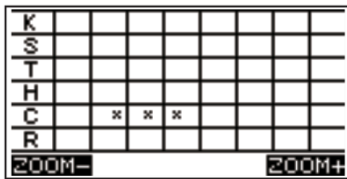

**ZOOM+**

Each time you press [+], the display is enlarged. This way you can display a beat in more detail.

**ZOOM-**

Each time you press [-], the display area is reduced. This way you can display more beats at the same time.

**Loop mode**

Press [LOOP] briefly to enter LOOP mode. Then long press [LOOP] to enter the Loop setting.

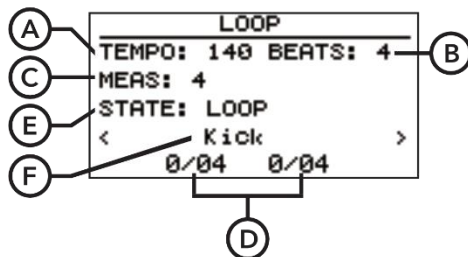

**A. Tempo**

Displays the currently set speed and can be adjusted in the metronome settings.

**B. Beats**

Displays the number of beats per measure and can also be set in the metronome settings.

**C. Meas**

Specifies how many bars are recorded in total. The possible setting range is between 1 and 16.

**D. Recording progress**

Displays the total bars and beats within a bar.

**E. State**

Displays the current status.

**F. Loop Start**

You can use the [<] and [>] keys to select a desired pad. When you hit this pad, the loop gets started. You can also trigger the loop by pressing the pad key.

## Loop recording

In LOOP mode, press [LOOP] again to switch to record mode. At this time, the indicator lamp lights steadily and the metronome turns on automatically. Strike any pad or pedal to start recording. It records in a loop according to the presets made, and then plays the recorded. Press [LOOP] again to stop recording.

**Notice:**

1. The device can save only one loop file, when recording again, the previously recorded file will be overwritten.
2. When the maximum number of recorded notes/beats (1000) is exceeded, recording stops automatically.

**LOOP playback**

In LOOP mode, press the Stop/Play button to play back the recorded MIDI data in loop. Press this key again to stop playback.

**LOOP settings**

Long press the [LOOP] button to enter the LOOP settings (as shown below).

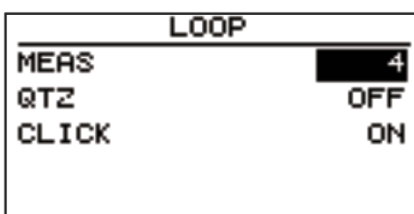
**MEAS**

Indicates how many bars are played/recorded in total.

**QTZ**

Automatically corrects the recorded beats based on the set value (quantize). This way you get a clean recording without the tiny timing differences heard in natural recordings.

The possible adjustable values are OFF, 1/4, 1/8, 3/8, 1/16, 3/16, 1/32, 1/64

**CLICK**

If this setting is ON, the metronome is activated during the loop function. Switching it OFF will deactivate the metronome again.

## Song mode

Press [J] to enter Song mode (as shown below).



### A. Song Name

Displays the name of the currently selected song. Use the [<] and [>] keys to switch between the different songs.

### B. Song volume

Use [+], [-] to adjust the volume of the songs.

### C. Loop playback display

Press the up arrow key to highlight the start point of loop playback. "(" will be displayed. Press this key again to mark the end of loop playback.

Pressing this button a third time will stop the loop playback and the song will resume normal playback. You can also loop an entire song and thus play it back in a loop.

### D. Playback progress

Displays the current measure in the song.

## Play to a song

Press the Stop/Play button to play the selected song.

Press the button again to stop playback.

Use the [MUTE] button to mute or activate the drum track in the song.

## Menu

Press the [MENU] key to enter the menu settings. (As shown below)

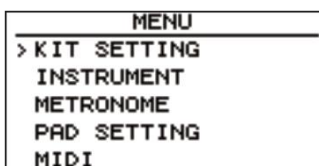

Use the down or up arrow keys to select the parameter to be set. Press [OK] to select the parameter. Press [↶] to return to the drum kit interface.

## Kit Setting (Settings)

Use [<] and [>] to select the drum kit you want to edit. Use the up and down arrow keys to select the parameter you want to adjust. Press [↶] to save and return to the previous interface.

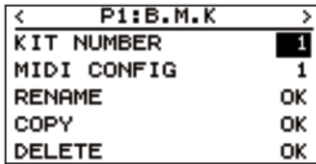

**KIT NUMBER**

Indicates the position of the currently selected drum kit. You can use the [+] and [-] keys to adjust the order of the drum kits. This changes the order in drum kit mode.

**MIDI CONFIG**

Use the [+] and [-] buttons to select one of the four MIDI codes for each drum kit.

**RENAME**

Under this point, you can rename the current drum kit. Press [OK] to enter the editing interface. You can move the cursor with all arrow keys to select characters, letters or numbers. Press [+] to enter and press [-] to delete characters. After the input is complete, press [OK] to save. Now press [↵] to complete the operation and return to the previous interface.



**COPY**

If you have selected the item "COPY" with the arrow keys, you can copy the current drum kit by pressing the [OK] key and go directly to its editing interface.

**DELETE**

To delete the current drum kit, you must first select the "DELETE" point with the arrow keys and then press [OK] to call up the confirmation menu. By pressing the [OK] button again, you confirm the deletion process (works only for USER kits).

Now press [↵] to complete the process and return to the previous interface.



**Instrument settings**

You can adjust the instruments (sounds) of each component in each drum kit in these settings. Before you change an instrument, go to the drum kit mode (Start-screen) and select the drum kit you want to change. Now return to the menu, select the "Instrument" point with the arrow keys and confirm with [OK]. Now use the [<] and [>] keys or hit the pad you want to change to select the desired pad and display it above (automatic switch setting must be on, see page 20 - AUTO TRACE).

Use the up or down arrow keys to select the parameter to be changed. Now press [↵] to complete the operation and return to the previous interface.

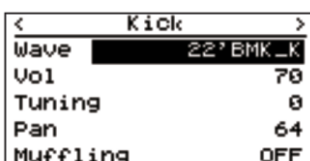

### Wave

Gives you the option to set different instruments/sounds for each pad. Use [+] and [-] to change the instrument. You can also press [OK] to enter the sound list menu, as shown below. Here you have a better overview of the different instruments.



In this menu, use [+] and [-] or the down and up arrow keys to select the instrument. Long press [+] or [-] to quickly scroll through the sound list. Now press [↵] to complete the process and return to the previous interface.

### VOL

Use the [+] or [-] buttons to adjust the volume of each instrument for each pad. Range: 0-127

### Tuning

Use the [+] or [-] keys to adjust the pitch of each instrument. The preset default is 0. Range: +/- 12 dB

### Pan

With the keys [+] or [-] you can control the panorama of each instrument. You can thus define whether the sound (e.g. on headphones) should be played back only on the left, in the middle or only on the right. 0 = all the way to the left, 64 = middle, 127 = all the way to the right. Range: 0-127

### Muffling

Use the [+] or [-] keys to adjust the instrument's damping level. The preset default is OFF. This does not work for all instruments. Range: 1-4

## PAD settings

Use the [<] and [>] keys or hit the pad to be changed to select the desired pad and display it above (automatic switch setting must be on, see page 20 - AUTO TRACE).

Use the up or down arrow keys to select the parameter to be changed. Now press [↵] to complete the operation and return to the previous interface.

KICK	
Sensibility	15
Curve	linear
Mask Time	15
Retrig Level	5
Anti-cross	5

### Sensibility

Use the [+] and [-] keys to change the sensitivity of the selected pad. Adjustable from 1-32. 1 is the lowest sensitivity, 32 is the most sensitive.

### Curve

This setting allows you to control the relationship between impact force and volume change via [+] and [-] key. The preset default is linear.

linear

The volume increases evenly the harder you hit the pad.

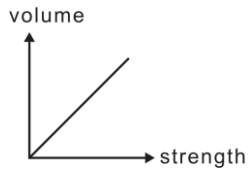

log

The volume reaches the maximum faster with less punch. Ideal for sounds you want to play without a large dynamic range.

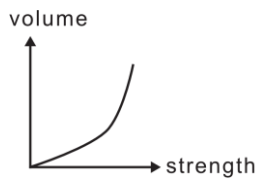

exp

The volume reaches the maximum more slowly or requires more punch. Ideal for sounds with additional nuances.

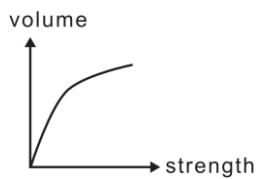

max

The volume reaches maximum even at the lowest impact force.

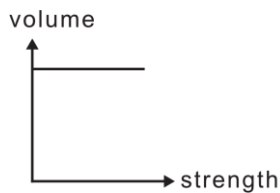

**Mask Time**

When playing a trigger (especially a kick trigger), the beater can spring back and hit the head a second time immediately after the intended hit. This causes a single hit to "double trigger" (two notes instead of one). The Mask Time setting helps to prevent this. Once a pad has been struck, any further trigger signals that occur within the specified Mask Time will be ignored.

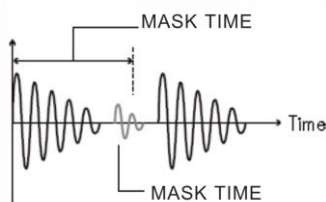



With a high value, it will thus be difficult to play very fast. Set this to as low a value as possible using the [+] and [-] keys. If the second hit is stronger than the previous one, Mask Time will not be activated. If you hit the skin only once but still two or more tones are produced, you can also set the Retrig level, see below. Range: 1-32

### Retrig Level

Especially important when using acoustic drum triggers. Such triggers can produce a wide variety of waveforms. E.g. they could lead to an unintended sound at point A in the following figure (re-trigger).

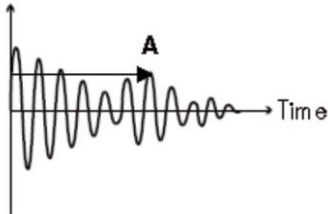

This occurs especially on the falling edge of the waveform. The Retrig level detects such distortions and prevents retriggering from occurring. Thus, at a high value, it becomes difficult to play very fast. Range: 1-10

### Anti-Cross

This function can be used to prevent a pad from sounding due to vibrations from another pad. The sound of the pad is thus only reproduced when the pad is struck lighter than the set dynamic level (velocity).

In the example (see Threshold), B sounds, but A and C do not.

At a higher value, no sound is produced when the pad is struck more lightly. Gradually increase the "Anti-Cross" value as you strike the pad. Check if hits on pads cause crosstalk on other components. Repeat this process until you get the perfect setting for your playing style.

### DR (dynamic range)

This setting enables the reception of a trigger signal in the range between the peak value and the minimum value. When set to a higher value, the range for the trigger signal or detection of the beats is larger.

### Threshold

This setting is used to adjust the allowed min. impact force for generating tones.

When set to a higher value, no sounds are played during light beats.

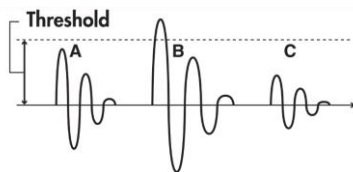

## MIDI settings

MIDI	
CHANNEL	9
MIDI IN	ON
MIDI OUT	ON
SYSTEM REAL	ON
MIDI CODE	OK

Use the up and down arrow keys to select the parameters to be adjusted. By pressing the [+] or [-] keys, you can change the value or type of the selected parameter.



**CHANNEL**

Specifies the MIDI channel number for transmission. Range: 0-15

**MIDI IN**

Sets whether MIDI data sent from an external MIDI device is received (ON) or not received (OFF). The preset default is ON.

**MIDI OUT**

Determines whether MIDI data is sent (ON) or not sent (OFF) to an external MIDI device. The preset default is ON.

**SYSTEM REAL**

Indicates whether the module sends MIDI device information. The preset default is OFF.

**MIDI CODE**

Specifies a MIDI code/note for a pad. If the MIDI code of multiple pads is the same, "\*" appears in front of the MIDI code. Press the [OK] key to open the page as below.



Use [<] and [>] to adjust the MIDI codes. Press the up or down arrow keys to select the desired pad. Then use [+] and [-] to change the values. Now press [P] to save and return to the previous interface.

**MIDI MAP**

Kick	Head	C2	36
Snare	Head	D2	38
	Xtick	C#2	37
	Rim	E2	40
HH	Pedal close	G#2	44
	Close head	F#2	42
	Close rim	A#0	22
	Open head	A#2	46
	Open half head	B0	23
	Open rim	D1	26
	Open half rim	C1	24
Ride	Head	D#3	51
	Rim	B3	59
	Bell	A4	69
Tom4	Head	F2	41
	Rim	D#2	39
Tom3	Head	G2	43
	Rim	A#3	58
Tom2	Head	A2	45
	Rim	B2	47
Tom1	Head	C3	48
	Rim	D3	50
Crash	Head	D#3	49
	Rim	G3	55
Crash2	Head	A3	57
	Rim	E3	52

## Options

OPTIONS	
LCD CONTRAST	10
AUTO TRACE	ON
HEAD/RIM LINK	OFF
SAVE OPTIONS	OK
LOAD OPTIONS	OK

Use the up and down arrow keys to select the parameters to adjust and use [+] and [-] to change the value or type of the selected parameters.

### LCD-CONTRAST

Adjust the display contrast. Range: 0-20

### AUTO TRACE

Turn the pad tracking function on or off. When the function is ON, hitting the pad automatically recalls the settings. The default value is ON.

### HEAD/RIM LINK

If you activate this function, you can change the tone of the drumhead simultaneously with an associated tone of the rim (edge of the drum). However, when you change the tone of the rim, the tone of the drumhead is not changed.

### SAVE OPTIONS

Saves all settings.

### LOAD OPTIONS

Restores the last saved settings and restarts the module.

### RESET

Select this option to reset the module to factory settings.

## Simplified EU Declaration of Conformity

Hereby Musikhaus Kirstein GmbH declares that the radio equipment type [Pronomic MOVE 112MA-A Akku-Aktivbox 12" and Pronomic MOVE 115MA-A Akku-Aktivbox 15"] complies with the directive 2014/53/EU.

The full text of the EU Declaration of Conformity is available at the following Internet address available:

[http://www.kirstein.de/docs/Konformitaetserklaerung/CE\\_Konformitaetserklaerung\\_00073463.pdf](http://www.kirstein.de/docs/Konformitaetserklaerung/CE_Konformitaetserklaerung_00073463.pdf)

[http://www.kirstein.de/docs/Konformitaetserklaerung/CE\\_Konformitaetserklaerung\\_00073464.pdf](http://www.kirstein.de/docs/Konformitaetserklaerung/CE_Konformitaetserklaerung_00073464.pdf)

## WEEE Declaration (Waste of Electrical and Electronic Equipment)

Your product has been designed and manufactured using high quality materials and components that are recyclable and reusable. The symbol means that your product must be disposed of separately from household waste at the end of its service life. Dispose of this device at your local collection point or recycling center.

Please help protect the environment in which we all live.

All technical data and appearances are subject to change without notice. All information was correct at the time of printing. Musikhaus Kirstein GmbH does not warrant the accuracy or completeness of the descriptions, photographs or statements contained in this manual. Printed colors and specifications may vary slightly from the product. Products of Musikhaus Kirstein GmbH are sold only through authorized distributors. Distributors and dealers are not representatives of Musikhaus Kirstein GmbH and are not authorized to legally bind Musikhaus Kirstein GmbH in any way.

 **KIRSTEIN.de**

Musikhaus Kirstein GmbH  
Bernbeurener Straße 11  
86956 Schongau - Germany  
Phone: 0049-8861/909494-0  
Fax: 0049-8861/909494-19

