

XDrum Schlagzeug Hocker

Aufbauanleitung

Sie finden die Aufbauanleitung zu Ihrem Drum Hocker online unter folgendem Link:

XDrum Semi

https://www.kirstein.de/docs/manuals/XDrum-Schlagzeughocker%20Semi-Aufbauanleitung_DE.pdf



XDrum DHS-1

https://www.kirstein.de/docs/manuals/XDrum-Schlagzeughocker%20DHS-1-Aufbauanleitung_DE.pdf



Um die Umwelt zu schützen, versenden wir diese Handbücher nicht in gedruckter Form. Sollten Sie dies dennoch wünschen, können Sie sich die Anleitungen ganz einfach unter den angegeben Links bzw. durch Scannen des QR Codes ausdrucken oder Sie kontaktieren uns direkt und wir schicken Ihnen diese in gedruckter Form per Post zu.

XDrum Drum Stool

Assembly instruction

You can find the Assembly instruction for your drum throne online under the following link:

XDrum Semi

https://www.kirstein.de/docs/manuals/XDrum-Drum%20Stool%20Semi-Assembly%20Instruction_EN.pdf



XDrum DHS-1

https://www.kirstein.de/docs/manuals/XDrum-Schlagzeughocker%20DHS-1-Assembly%20Instruction_EN.pdf



In order to protect the environment, we do not send these manuals in printed form. Should you nevertheless wish to do so, you can easily print out the instructions using the links or QR code provided or contact us directly and we will send them to you in printed form by post.



DD-530 Mesh Head E-Drum



User manual

INFORMATION FOR YOUR SAFETY!

THE FCC REGULATION WARNING (for USA)

This equipment has been tested and found to comply with the limits for a Class B digital device, pursuant to Part 15 of the FCC Rules.

These limits are designed to provide reasonable protection against harmful interference in a residential installation. This equipment generates, uses, and can radiate radio frequency energy and, if not installed and used in accordance with the instructions, may cause harmful interference to radio communications. However, there is no guarantee that interference will not occur in a particular installation. If this equipment does cause harmful interference to radio or television reception, which can be determined by turning the equipment off and on, the user is encouraged to try to correct the interference by one or more of the following measures:

- Reorient or relocate the receiving antenna.
- Increase the separation between the equipment and receiver.
- Connect the equipment into an outlet on a circuit different from that to which the receiver is connected.
- Consult the dealer or an experienced radio/TV technician for help.

Unauthorized changes or modification to this system can void the user's authority to operate this equipment.

CAUTION

The normal function of the product may be disturbed by Strong Electro Magnetic Interference. If so, simply reset the product to resume normal operation by following the owner's manual. In case the function could not resume, please use the product in other location.

PRECAUTIONS

PLEASE READ CAREFULLY BEFORE PROCEEDING

Please keep this manual in a safe place for future reference.

Power Supply

Please connect the designated AC adaptor to an AC outlet of the correct voltage.

Do not connect it to an AC outlet of voltage other than that for which your instrument is intended.

Unplug the AC power adaptor when not using the instrument, or during electrical storms.

Connections

Before connecting the instrument to other devices, turn off the power to all units. This will help prevent malfunction and / or damage to other devices.

Location

Do not expose the instrument to the following conditions to avoid deformation, discoloration, or more serious damage:

- Direct sunlight
- Extreme temperature or humidity
- Excessive dusty or dirty location
- Strong vibrations or shocks
- Close to magnetic fields

Interference with other electrical devices

Radios and televisions placed nearby may experience reception interference. Operate this unit at a suitable distance from radios and televisions.

Cleaning

Clean only with a soft, dry cloth.

Do not use paint thinners, solvents, cleaning fluids, or chemical-impregnated wiping cloths.

Handling

Do not apply excessive force to the switches or controls.

Do not let paper, metallic, or other objects into the instrument. If this happens, unplug the AC adaptor from the wall outlet. Then have the instrument inspected by qualified service personnel.

Disconnect all cables before moving the instrument.

Panel & Display Description

Front Panel.....	4
Rear & Side Panel.....	5
Display.....	5

Quick Start

Setup

Connecting Pads and Pedals.....	6
---------------------------------	---

Connections

Connecting an Audio Equipment.....	7
Connecting a set of Headphones.....	7
Connecting an MP3/CD Player.....	7
Connecting a Computer.....	7
Connecting a Midi Keyboard.....	7
Power Supply & Switch.....	7

Performing

Selecting a Drum Kit.....	8
Playing the Pads.....	8
Adjusting the Sensitivity of a Pad.....	9
Using the Metronome/Click Feature.....	9
Adjusting the Tempo.....	9

Editing and Saving a Drum Kit

Adjusting the Volume of a Drum Kit.....	10
Switching Reverb On/Off and Setting EQ.....	10
Selecting the Drum Instrument of the Pad.....	10
Adjusting the Volume, Pan and Pitch of the Pad.....	10
Setting the Pads to Play Songs.....	10
Saving the Edited Kit.....	10

Playing Along with Songs

Selecting and Playing Back a Song.....	11
Adjusting the Volume of the Accompaniment and Drum.....	11
Muting the Drums in Songs.....	11
Using the Pads to Play Songs.....	11

Recording Your Performance

Recording Your Performance Quickly.....	12
Playing Back Your Recorded Performance.....	12
Making the Settings for Recording.....	12

Practicing with Patterns

Selecting a Pattern and Practicing with it.....	13
Scoring Your Practice.....	13
Playing Back Your Recorded Practice.....	13

Advanced Use

Creating Your Own Drum Kit

About the Drum Kits.....	14
Selecting a Drum Kit.....	14
Overall Drum Kit Setting.....	14
Selecting the Pad to Edit.....	14
About the Drum Instruments.....	15
Selecting Instruments.....	15
Drum Instrument Setting.....	15

Settings for Other Functions.....	15
Saving to a User Drum Kit.....	15

Making the Settings for Pads

About Settings of Pads.....	16
Adjusting the Pad Sensitivity.....	17
Setting the Pad Threshold.....	17
Eliminating Crosstalk between Pads.....	17
Selecting the Pad Curve.....	17
Setting Rim Sensitivity on Pads.....	18
Adjusting the Hi-Hat Pedal Splash Sensitivity.....	18
Saving Settings of Pads.....	18

Setting the Metronome

About Click.....	19
Switching the Click On/Off.....	19
Adjusting the Click Tempo.....	19
Setting the Time Signature.....	19
Setting the Interval.....	19
Adjusting the Click Volume.....	19
Selecting the Click Sound.....	19

Playing Back Songs

About Songs.....	20
Selecting a Song.....	20
Playing Back a Song.....	20
Adjusting the Accompaniment Volume.....	20
Adjusting the Drum Volume.....	20
Muting the Drums in Songs.....	20

Recording a Song

About Recording.....	21
Recording Pad Performances.....	21
Recording Performances Accompanied with a Song...20	
Playing Back Your Recorded Performance.....	21
Recording Standby.....	21

Practicing in Learning Mode

About Learning Mode.....	22
Practicing with Beats.....	22
Practicing with Rhythms.....	23
Practicing with Patterns.....	23
Recording and Scoring Your Practice.....	24
Playing Back Your Recorded Practice.....	24

Making the Setting for MIDI

About MIDI.....	25
Making the MIDI Settings.....	25
Connecting with an External Sound Device.....	26
Using the digital drum as a Sound Module.....	26

Appendices

Prompt Messages.....	27
Troubleshooting.....	27
Specifications.....	28
Kit/Voice/Song/Pattern/Parameter List.....	29
MIDI Implementation Chart.....	39

Panel Description

Front Panel

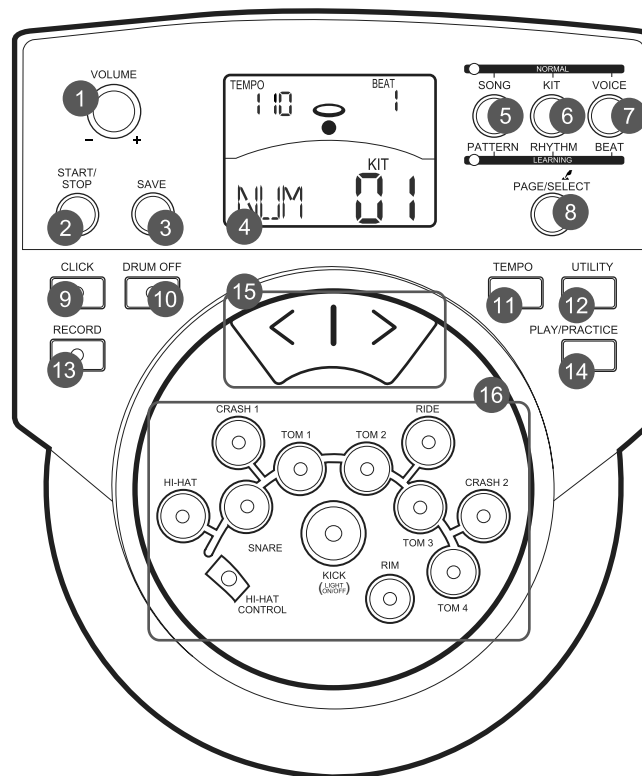

1. VOLUME Knob

Adjust the volume of phone and line output.

2. START/STOP Button

Start or stop playing.

3. SAVE Button

This button is used to save the current kit settings in a user kit and save the trigger settings under the Utility menu pages.

4. LCD Display

Please refer to the LCD Display section.

5. SONG/PATTERN Button

Enter the Song menu in NORMAL mode or enter the Pattern Practice menu in LEARNING mode.

6. KIT/RHYTHM Button

Enter the Kit menu in NORMAL mode or enter the Rhythm Practice menu in LEARNING mode.

7. VOICE/BEAT Button

Enter the Voice menu in NORMAL mode or enter the Beat Practice menu in LEARNING mode.

8. PAGE/SELECT Button

Scroll through the menu pages. Press and hold it for 1 second to switch modes between NORMAL and LEARNING.

9. CLICK Button

Turn the metronome on or off and enter the Click menu in NORMAL mode.

10. DRUM OFF Button

Mute the drum part of the pattern.

11. TEMPO Button

Adjust the current tempo.

12. UTILITY Button

Enter the Utility menu in NORMAL mode.

13. RECORD Button

Enter the Record menu in NORMAL mode.

14. PLAY/PRACTICE Button

Play back your recording in NORMAL mode. Start practicing following sample practice patterns in LEARNING mode. Press and hold it for 1 second to play back your practice in LEARNING mode.

15. <Button and> Button

Press the [>] button increases and press [<] button decreases the current parameter.

16. Pad Select Buttons

These buttons play the pad voices of the current kit. In Voice menu and Utility menu, they select the pad to be edited.

Rear Panel & Side Panel

17. AUX IN Jack(1/8")

This stereo input jack is for an external sound source, such as an MP3 or CD player.

18. LINE OUTPUT Jacks(1/4")

Stereo output connection to an audio system or drum amplifier.

19. CRASH 2 Jack(1/4")

Input connection for Crash 2 (dual-zone).

20. TOM 4 Jack(1/4")

Input connection for Tom 4 (dual-zone).

21. MIDI Connectors (IN, OUT)

These ports allow communication with other products equipped with a MIDI interface.

22. USB Connector

This port is used to connect to a computer (MIDI In/Out via USB).

23. PAD Connectors

Input connections for Kick, Snare, Tom, Cymbal pads and Hi-Hat control pedal.

24. PHONES Jack(1/8")

This stereo jack is used to connect headphones to the unit.

25. POWER Switch

This switch turns the power on and off.

26. DC IN Jack

Connect the included DC 9V power adaptor.

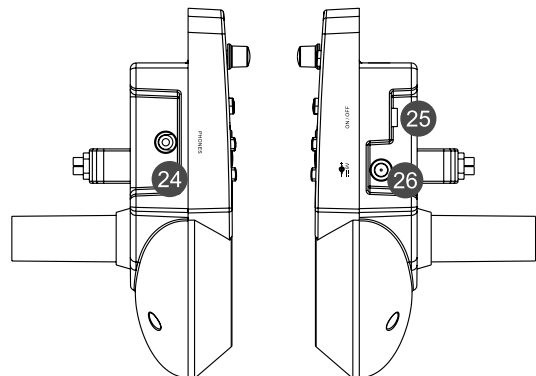
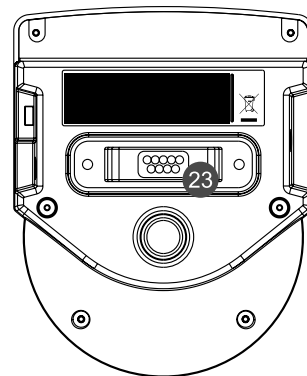
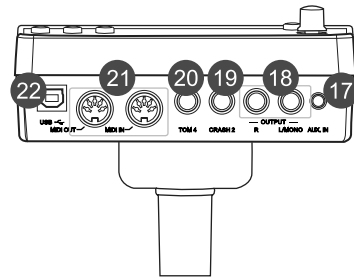

Display

1. Tempo/Measure

2. Hitting Indicator

3. Beat Count

4. Indicators for Learning

5. Indicators for Menus (Such as UTILITY, REC, etc.)

6. Current Mode and Parameter Display

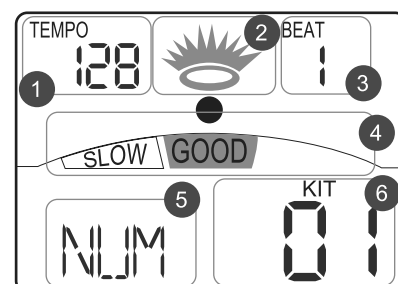

Setup

Caution!

To prevent electric shock and damage to the device, make sure the power is switched OFF on the drum and all related device before making any connection.

Connecting Pads and Pedals

Standard: KICK, SNARE, TOM1-3, CRASH1, RIDE, HIHAT, HIHAT CONTROL PEDAL

Extended: CRASH2, TOM4

Using the provided cables, connect with kick, snare, tom1~tom3, ride, crash, hi-hat, hi-hat control triggers. Snare, tom, ride, crash are stereo input, support double triggering (increase edge triggering); kick, hi-hat are mono input, which can't response edge triggering. Hi-hat control pedal is stereo input.

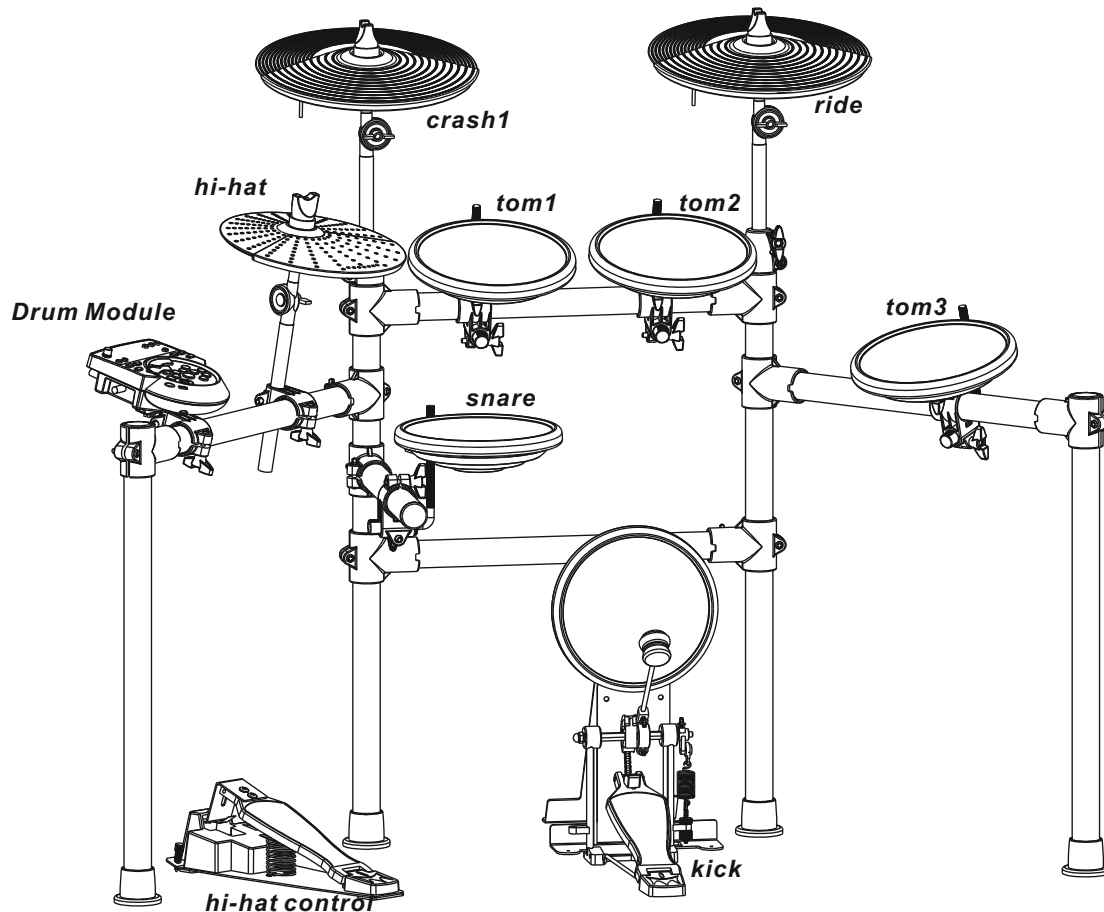

Note:

For details on assembling the drum stand, attaching the digital drum and connecting pads, refer to the Installation manual.

Connections

Connecting an Audio Equipment

When using an amplifier, connect the Output L/MONO and R jacks on the rear panel to the input of the amplifier.

Note:

For mono playback, use the L/MONO jack.
For stereo playback, connect both L/MONO and R jacks.
The line output volume is controlled by the VOLUME knob.

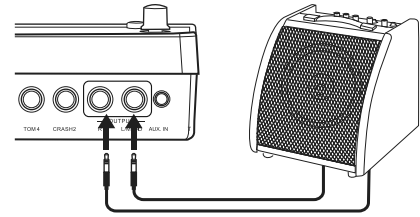

Connecting a set of Headphones

An optional set of stereo headphones can be connected to the PHONES jack located on the side of the drum module. The headphones output volume is controlled VOLUME knob, too.

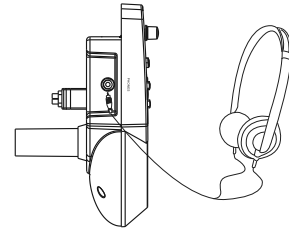

Connecting an MP3/CD Player

Connect the audio output of an MP3/CD player or other audio source to the stereo AUX IN jack on the rear panel. The input signal is mixed with the drum signal, allowing you to play along.

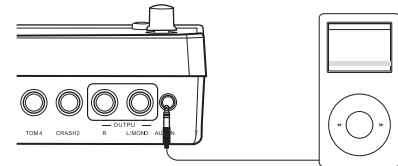

Connecting a Computer

■ Via the USB Connector

This receives and transmits MIDI messages.

■ Via the MIDI Connectors

MIDI IN Connector

This receives MIDI messages transmitted from an external MIDI device or a computer.

MIDI OUT Connector

Pad performance data is transmitted from this connector to connected computer or MIDI device.

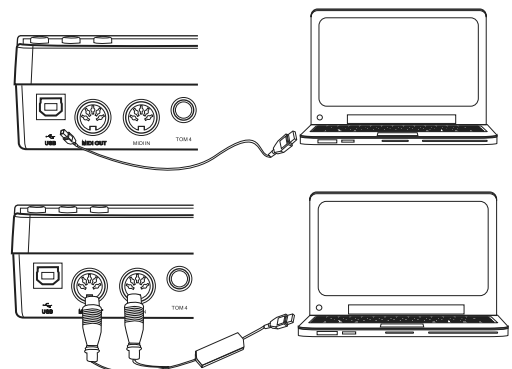

Connecting a Midi Keyboard

If you're using an external MIDI keyboard or pads to control the digital drum, make connections as shown. Here, it is used as a sound module.

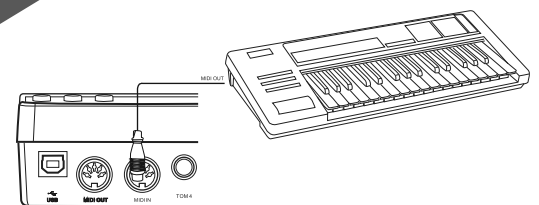

Power Supply & Switch

Make sure the power is switched OFF. Connect the power adaptor to the DC IN jack on the side panel. After confirming that all connections have been completed, rotate the volume knob to the left (minimum volume level) before switching the power on. Set the power switch to the "ON" position. The KIT indicator on LCD will light up and the display will show kit number 01.

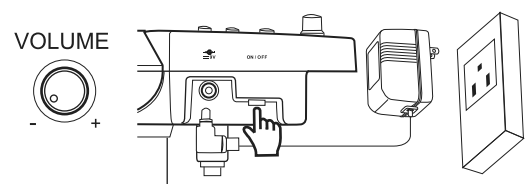

Note:

Make sure the power is switched OFF when connecting the drum module with external devices.

Performing

Selecting a Drum Kit

After powering up, the digital drum will be in KIT menu (KIT indicator ON). The display should look like this:

1. Use the [<] and [>] buttons to select the active kit.

There are 45 kits in the digital drum:

- 29 preset kits (Kits 01-29)
- 16 user kits (Kits 30-45), the parameter display area will display as "U30~U45", with an additional letter "U".

2. Pressing the Pad Select buttons allows you to preview the current kit (fixed velocity).

3. Hit the pads to play the current kit.

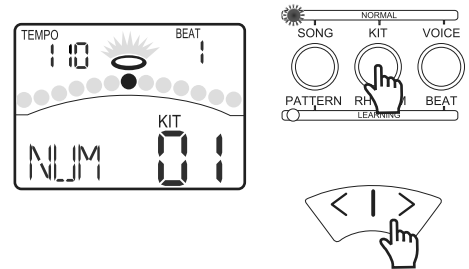

Playing the Pads

Similar to an acoustic drum kit, the digital drum responds differently to various playing techniques and dynamics. All the pads are velocity sensitive. And some voices change timbre depending on the striking force.

Drum Pad Head or Rim shot

The digital drum pad detects head and rim shots (rim shots trigger the rim voice).

Cymbal Bow shot and Rim shot

The digital drum cymbals detect bow shot and rim shots (rim shots trigger the rim voice).

Both Ride and Crash cymbals have cymbal choke. But hi-hat don't have the cymbal choke

Choking the crash/ride edge with the hand immediately after hitting the crash/ride mutes the crash/ride sound.

Hi-Hat

The Hi-Hat sound varies depending on the position of the Hi-Hat pedal:

Open Hi-Hat: Strike the Hi-Hat pad without pressing the pedal.

Half-Open Hi-Hat: Strike the Hi-Hat pad with the pedal pressed halfway down.

Closed Hi-Hat: Strike the Hi-Hat pad with the pedal pressed completely down.

Pedal Close: Press the pedal completely down without striking the pad.

Splash: Press the pedal completely down and release it immediately.

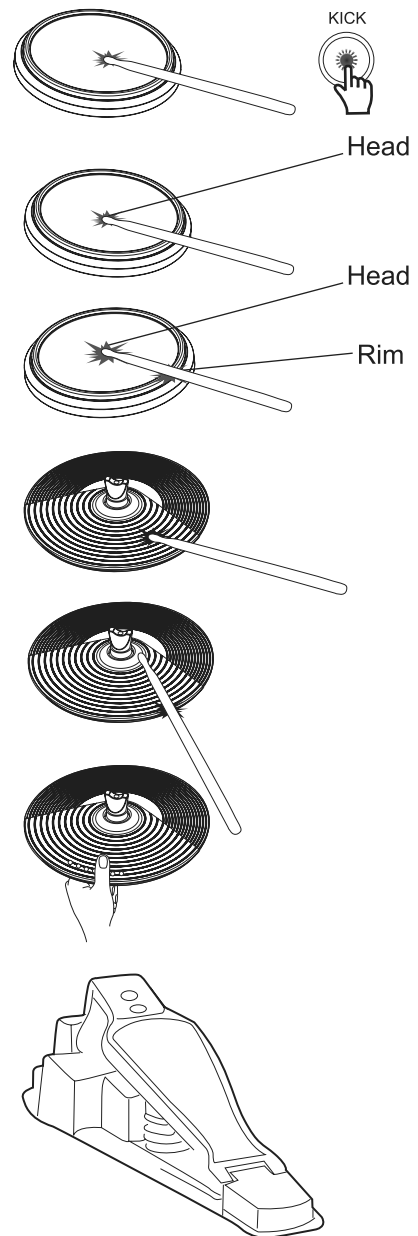

Adjusting the Sensitivity of a Pad

You may wish to adjust the sensitivity of the pads according to your playing style and desired dynamic range.

1. Press the [UTILITY] button
The UTILITY indicator appears.
2. Strike a pad or press a pad select button to select the one whose sensitivity is to be adjusted. The PAD indicator shows the current selected pad.
3. Press the [<] or [>] button to adjust the sensitivity.
4. Press the [SAVE] button to save the current setting.

For details on pad adjustments, refer to **Advanced Use**.

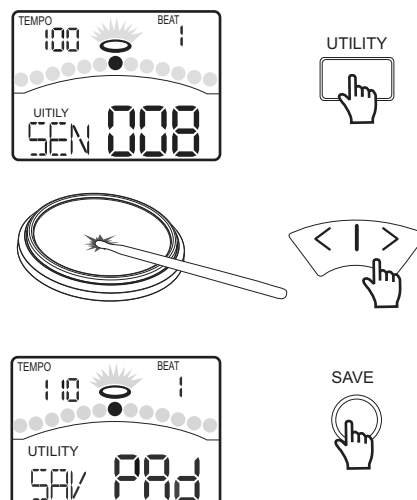

Using the Metronome/Click Feature

You can switch the click sound on and off by pressing [CLICK] button. When the click plays at the current Time Signature and Tempo (displayed in the top left corner of the LCD), the beat indicators will swing accordingly. You can set the time signature and interval, adjust the click volume and select the click sound in the CLICK menu.

1. Press the [CLICK] button.
Start the metronome with click sound.
2. Press the [PAGE] button to select the click menu pages and press the [<] or [>] button to adjust the parameters.
3. Press the [CLICK] button again.
Stop the metronome and exit the click menu.

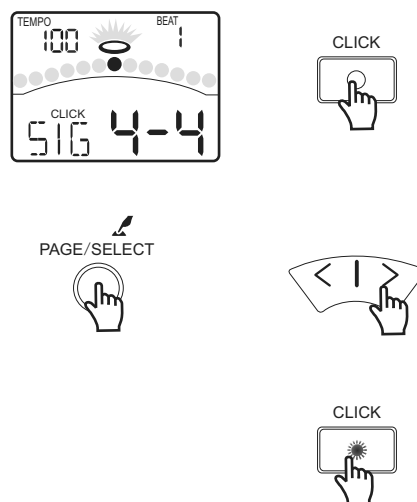

Adjusting the Tempo

You can adjust the tempo of the Metronome, the current song, and the current learning pattern. The current tempo always displays in the top left corner of the LCD.

1. Press the [TEMPO] button.
2. Press the [<] or [>] button.
Adjust the current tempo.
3. Press both [<] and [>] buttons at the same time, reset the current tempo to its default value.

Note:

If there's no operation, it will return to the previous menu page automatically after 3 seconds.

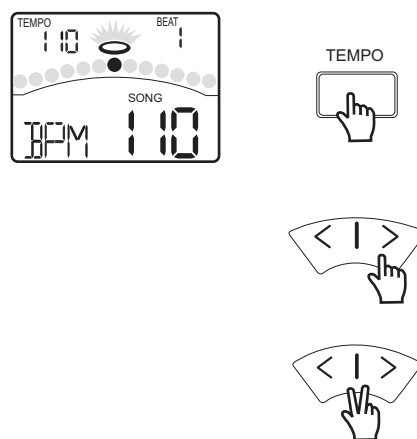

Editing and Saving a Drum Kit

In KIT menu, you can modify the parameters as you like and save to the selected user kit.

Adjusting the Volume of a Drum Kit

1. Press the [KIT] or [PAGE] button.
Select the Kit Volume page.
2. Press the [<] or [>] button.
Adjust the kit volume.

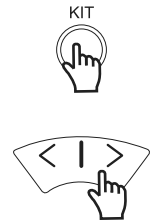
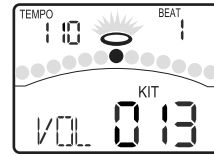

Switching Reverb On/Off and Setting EQ

1. Press the [KIT] or [PAGE] button.
Select the Global Reverb page and EQ pages.
2. Press the [<] or [>] button.
Switch Reverb ON or OFF.
Set the gain of three-band EQ (high, middle, low)

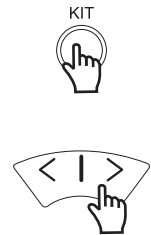
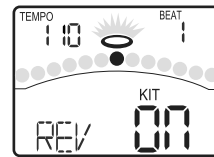

Selecting the Drum Instrument of the Pad

1. Press the [VOICE] button.
Select the Pad Voice page.
2. Press the [<] or [>] button.
Select the drum instrument of the selected pad.
Please refer to **Drum Instrument List**.

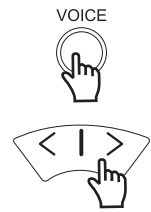
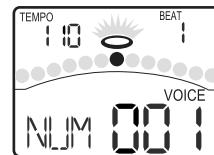

Adjusting the Volume, Pan and Pitch of the Pad

1. Press the [VOICE] or [PAGE] button.
Select the Pad Volume, Pad Pan, and Pad Pitch pages.
2. Press the [<] or [>] button.
Adjust the corresponding parameter.

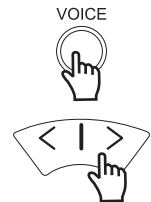
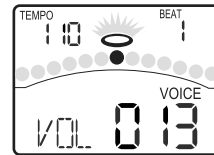

Setting the Pads to Play Songs

1. Press the [VOICE] or [PAGE] button.
Select the Pad Song and Song Number pages.
2. Press the [<] or [>] button.
Switch the Pad Song function ON or OFF. Select the Song that begins playing when the following pad is struck.

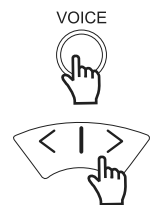
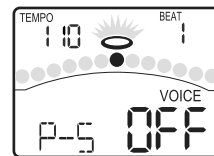

Saving the Edited Kit

1. Press the [SAVE] button.
The number of user kit will be flashed.
2. Press the [<] or [>] button.
Select a user kit to save your settings. (No. 30-45)
3. Press the [SAVE] button again.
Save the setting to the selected user kit.

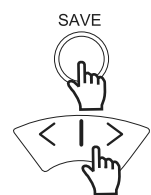
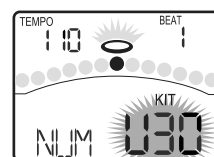

HINT

If the edited kit isn't saved before selecting another kit, powering down the digital drum, the changes will be lost.

Playing Along with Songs

Selecting and Playing Back a Song

1. Press the [SONG] button.
Switch to the SONG menu.
2. Press the [<] or [>] button.
Select the active song. The digital drum has many kinds of songs. Please refer to Song list.
3. Press the [START/STOP] button.
Start or stop playing back this selected song. When playing back this song, the PAD indicator will display which pads are being played by drum track.

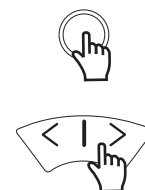
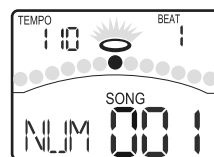

Adjusting the Volume of the Accompaniment and Drum

In SONG menu, you can adjust the volume of drum or accompaniment track.

1. Press the [SONG] or [PAGE] button.
Select the ACC Volume or Drum Volume page.
2. Press the [<] or [>] button.
Adjust the corresponding volume.

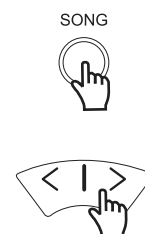

Muting the Drums in Songs

If you want to mute the drum track of the song, please press the [DRUM OFF] button. The [DRUM OFF] LED will turn on.



Using the Pads to Play Songs

This function is available only with electric drum. When you struck the pads that have been set Pad Song function, they will start the performance of the songs. If you don't know how to set this function, please return to previous page and review the part "**Setting the Pads to Play Songs**".

For Example :

Kick: You can play the bass-line (Tap group, refer to **Song List**) note by note with you kick drum.

Crash: The chords (Hit group, refer to Song List) progress when you strike the pad.

HINT

The sounds in the Tap song are played back one by one when you pressing the [START/STOP] button or hitting the "pad song" pad.

Recording Your Performance

In RECORD menu, you can record pad performances and the song as accompaniment.

Recording Your Performance Quickly

1. Press the [RECORD] button.
The [RECORD] LED will flash. The Metronome will be turned on automatically.
The display will show:
2. Press the [START/STOP] button or strike the pad.
Recording will start.
The [RECORD] LED will turn on.
3. Press the [START/STOP] button again, or press the [RECORD] button.
Stop recording, the [RECORD] LED will turn off.
Your performance has been recorded.

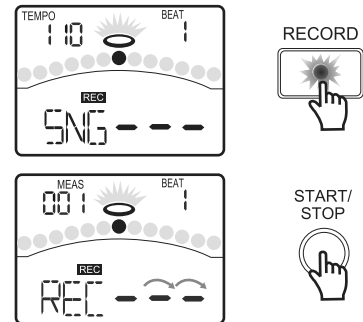

Playing Back Your Recorded Performance

1. Press the [PLAY] button.
Play back your recording.
The display will show:
2. Press the [PLAY] button again.
Stop playing back your performance.

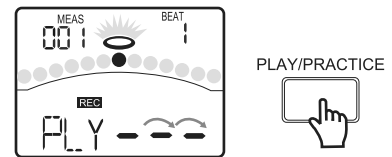

If you are not satisfied with your recording, please press the [RECORD] button to restart the recording progress.

Making the Settings for Recording

You can make the settings for recording on Record Standby.

1. Press the [PAGE] button.
Select the Record Setting pages.
2. Press the [<] or [>] button.
Adjust the parameters about recording.
For details on record setting, refer to Advanced Use.

PAGE/SELECT

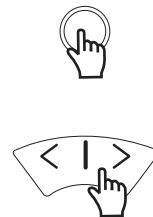

Practicing with Patterns

There are three types of patterns in LEARNING mode.

Beat: Snare Practice

Rhythm: Drums Practice

Pattern: Drums Practice with accompaniment

Selecting a Pattern and Practicing with it

When you are in NORMAL mode, please press and hold the [PAGE/SELECT] button for 1 second. The LED of LEARNING mode will turn on. The display will show:

1. Press the [BEAT] button.
Select the Beat Choosing page.
2. Press the [<] or [>] button.
Select the beat which you want to practice.
3. Press the [PRACTICE] button.
Start or stop playing the pattern with your practice. The PAD indicators will display which pads are being played by drum track.

If you want to select the Rhythm or Pattern, please follow the steps described above. Drum Lessons Score can be downloaded from internet(consult your dealer). We recommend you to follow it.

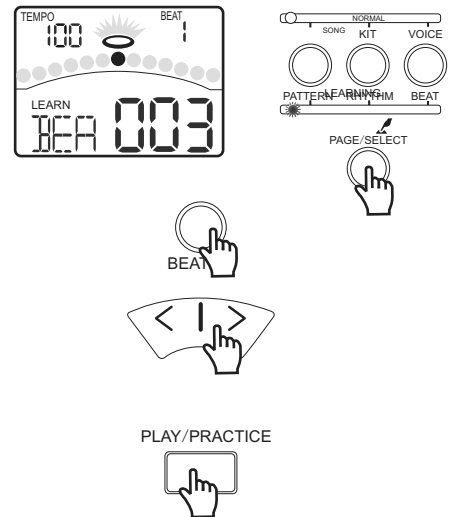

Scoring Your Practice

If you want to check your progress, please press the [START/STOP] button. The display will show:

A measure count-in will be inserted before playing back the pattern so that you can practice in good time. Your practice will be recorded automatically. When finished playing back the pattern, the digital drum will score your practice automatically. The display will show the score.

If you are unsatisfied with your score, please press the [START/STOP] button and restart examination.

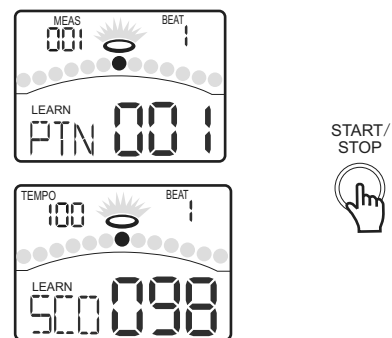

Playing Back Your Recorded Practice

1. Press and hold the [PLAY/PRACTICE] button for 2 seconds.
The display will show:
You will listen to your recorded practice.
2. Press the [PLAY/PRACTICE] button again.
Stop playing back the recorded practice.

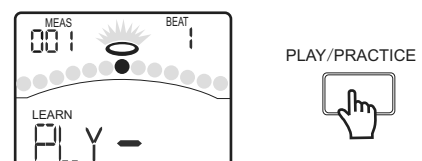

Creating Your Own Drum Kit

About the Drum Kits

In KIT menu, you can select drum kits to play from the pads, and you can edit voices and their associated parameters, such as Pitch, Reverb Level, Volume, Pan, MIDI Note, etc.

There are 45 kits in the digital drum:

- 29 preset kits (Kits 01-29)
- 16 user kits (Kits U30-U45)

In addition, there are 11 General MIDI preset kits for MIDI/USB applications, and for MIDI file playback. Please refer to **GM Drum Kit List**. Each drum kit contains settings for up to 19 voices, assigned to the 10 pad inputs and 1 pedal controller:

Pad Settings		
Kick	Head1	
Snare	Head2	Rim2
Tom1	Head3	Rim3
Tom2	Head4	Rim4
Tom3	Head5	Rim5
Tom4	Head6	Rim6
Crash1	Head7	Rim7
Crash2	Head8	Rim8
Ride	Head9	Rim9
Hihat	Head10	
Pedal		

Selecting a Drum Kit

If the digital drum is not yet in KIT menu, press the [KIT] button to enter it. The KIT indicator will light up, and the LCD will display the current kit number.

Press the [<] or [>] buttons to select a kit. When holding down [>], values increase rapidly. When holding down [<], values decrease rapidly.

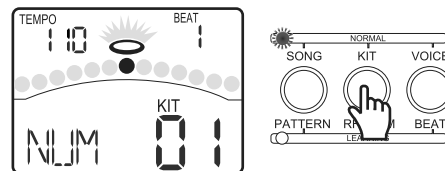

Overall Drum Kit Setting

In KIT menu, you can set the overall kit parameters.

1. Press the [PAGE] or [KIT] button, select Kit volume page. The parameter adjusts the overall kit volume(0-32).
2. Press the [PAGE] or [KIT] button, select Reverb Switch page. The parameter toggles the global reverb Switch ON/OFF.
3. Press the [PAGE] or [KIT] button, select EQ gain page. These parameters adjust the three bands of Master EQ (-12dB-12dB).



Overall Kit Settings	
Kit	Volume
Global	Reverb on/off
	EQ High gain
	EQ Middle gain
	EQ Low gain

Selecting the Pad to Edit

The current pad to be edited can be selected either by pressing its Pad Select button, or by striking the pad itself. The PAD indicator will light up to show which pad is currently selected. If the rim of a pad is selected, both the PAD indicator and the RIM indicator will turn on.

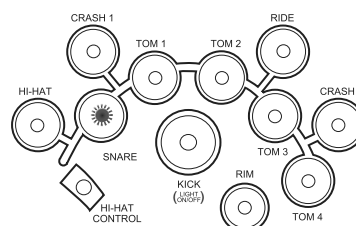

About the Drum Instruments

The digital drum features 400 different drum instruments which are categorized into 9 separate groups, such as Acoustic Kick, Electric Kick, Acoustic Snare, Electric Snare, Percussion. You can individually adjust the volume, pan, pitch, reverb settings for instruments set to the pad.

Selecting Instruments

If the digital drum is not yet in VOICE menu, press the [VOICE] button to enter it. The VOICE indicator will light up, and the LCD will display the current voice number.

1. Press the [<] or [>] buttons to change a pad's Individual voice (001-400).
2. If the selected pad is Hi-Hat, an additional option is available: Hi-Hat Combination (001-007).

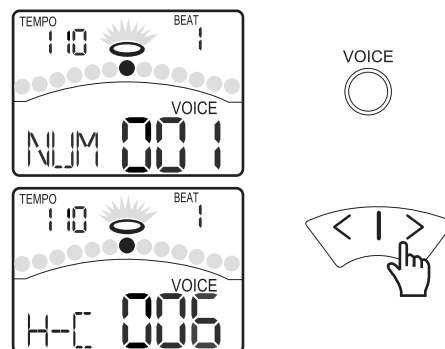

Drum Instrument Settings

1. Press the [PAGE] or [VOICE] button, select Pad Volume page. The parameter adjusts the volume of the pad.
2. Press the [PAGE] or [VOICE] button, select Pad Pan page. The parameter adjusts the pan of the pad.
3. Press the [PAGE] or [VOICE] button, select Pad Pitch page. The parameter adjusts the pitch of the pad.
4. Press the [PAGE] or [VOICE] button, select Pad Reverb page. The parameter adjusts the reverb level of the pad.

Drum Instrument Settings	
Voice Setting	Volume(0-32)
	Pan(-8-8)
	Pitch(-8-8)
	Reverb(0-16)
Settings for Other Functions	
MIDI	MIDI Note(0-127)
Others	Pad Song Switch(ON/OFF)
	Song Number(1-80)

Settings for Other Functions

1. Press the [PAGE] or [VOICE] button, select Pad MIDI Note page. The parameter sets MIDI Note Number for each pad.
2. Press the [PAGE] or [VOICE] button, select Pad Song pages. The parameters sets pad song function ON and choose the song numbers.

Press the [<] or [>] buttons to adjust the parameters.

HINT
While editing Voice Number, Pitch, Pan, Volume, and Reverb, you can also preview the result of the current settings by pressing the Pad Select button to play the edited voice.

Saving to a User Drum Kit

After change any kit parameter, please press the [SAVE] button to save the current settings to the user kit (No. 30-45). The number of user kit will be flashed. Press the [SAVE] button to save to user kit and return to Kit Select page.

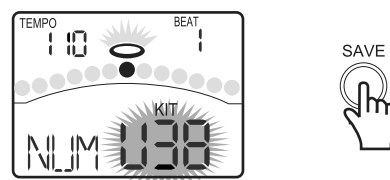

Making the Settings for Pads

About Settings of Pads

If the digital drum is not yet in UTILITY menu, press the [UTILITY] button to enter it.

The UTILITY indicator will light up. You can use the [<] or [>] buttons to adjust parameters (as shown to the right) for each pad as well as the rim sensitivity of the pad and the splash sensitivity of the Hi-Hat control pedal.

The current pad to be edited can be selected either by pressing its Pad Select button, or by striking the pad itself. The PAD indicator will light up to show which pad is currently selected. If the rim of a pad is selected, both the PAD indicator and the RIM indicator will turn on.

Sensitivity: Adjust the sensitivity of the pad to regulate the pad response. Higher settings result in higher sensitivity, so that the pad will produce a loud volume even when struck softly. You can also adjust the sensitivity of the splash in SPLASH SENSITIVITY.

Threshold: This setting allows a trigger signal to be received only when the pad is struck harder than a specified force. This can be used to prevent a pad from sounding in response to extraneous vibrations from another pad.

Crosstalk: When two pads are mounted on the same stand, the vibration produced by hitting one pad may trigger the sound from another pad unintentionally (This is called crosstalk). You can avoid this problem by adjusting Crosstalk Cancel on the pad that is sounding inadvertently. If the value is set too high, then when two pads are played simultaneously, the one that is struck less forcefully will not sound. So be careful and set this parameter to the minimum value required to prevent such crosstalk. With a setting of 0 , crosstalk prevention does not function.

Curve: This setting allows you to control the relation between the velocity (striking force) and changes in volume (the dynamic curve). Adjust this curve until the response feels as natural as possible.

Pad Settings	
	Sensitivity(1-16)
	Threshold(0-16)
	Crosstalk(1-16)
Pad	Curve(1-6)
Special	Rim Sensitivity(1-16)
	Splash Sensitivity(1-9)

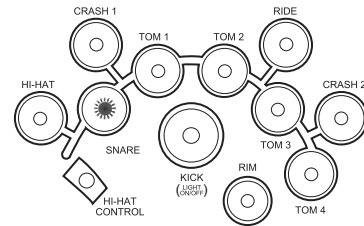

Adjusting the Pad Sensitivity

Press the [PAGE] or [UTILITY] button, select Pad Sensitivity page. The display will show:

Changes how a pad responds to your playing. At higher sensitivities, the pad will generate a louder signal, even when you play softly. At lower sensitivities, the pad will generate a quieter signal, even if you play strongly. Adjust according to your playing style and desired dynamic range.

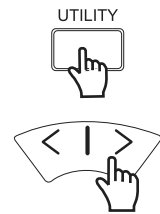
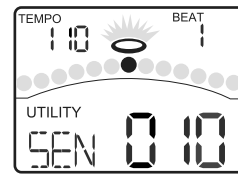

Setting the Pad Threshold

Press the [PAGE] or [UTILITY] button, select Pad Threshold page. The display will show:

Changes how forcefully you must strike the pad to generate a trigger signal. Setting a high threshold requires hitting the pad very hard to get a sound. This can help cut out transient responses, such as vibrations from the kit or accidental pad taps that you don't intend to generate sounds. Setting a low threshold means even light touches will produce sound. Adjust according to environment and playing style.

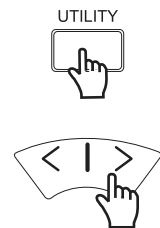
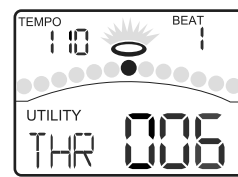

Eliminating Crosstalk between Pads

Press the [PAGE] or [UTILITY] button, select Pad Crosstalk page. The display will show:

When two pads are mounted close to each other, hitting one pad may trigger the sound from another pad unintentionally. This effect can be eliminated by setting this parameter to a higher value on the pad is triggered unintentionally.

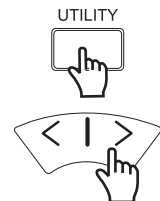
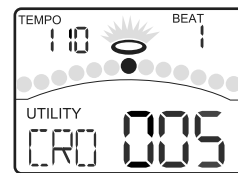

HINT

If the value is set too high, then when two pads are played simultaneously, the one that is struck less forcefully will not sound. So be careful and set this parameter to the minimum value required to prevent such crosstalk.

Selecting the Pad Curve

Press the [PAGE] or [UTILITY] button, select Pad Curve page. The display will show:

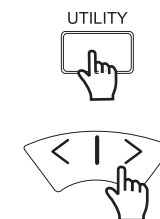
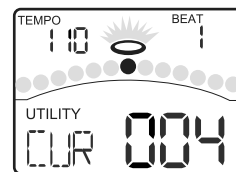

Making the Settings for Pads

Curve refers to how the trigger signal's dynamic response relates to your pad hit.

Curve1: The standard setting, this produces the most natural correspondence between playing dynamics and volume change.

Curve2, 3: Compared to Curve1, strong dynamics produce a greater change.

Curve4, 5: Compared to Curve1, a soft playing produces a greater change.

Curve6: Very little dynamic response, making it easy to maintain strong volume levels. If using drum triggers, these settings help maintain stable levels.

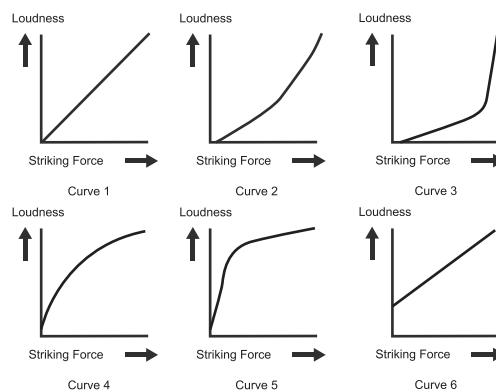

Setting Rim Sensitivity on Pads

You can only set rim sensitivity on Snare, Tom1, Tom2, Tom3, Tom4. If you select the other pads, this page will not appear. Press the [PAGE] or [UTILITY] button, select Pad Rim Sensitivity page. The display will show: Same as the basic sensitivity feature, except that it relates specifically to playing the rim.

Note:

This parameter can be adjusted only on SNARE, TOM1, TOM2, TOM3, TOM4. If you select the other pads on this page, a horizontal line "----" appears, and you can't make the setting.

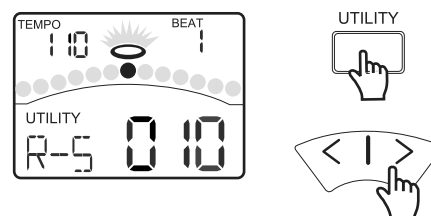

Adjusting the Hi-Hat Pedal Splash Sensitivity

Press the [PAGE] or [UTILITY] button, select Pedal Splash Sensitivity page. The display will show:

This Setting control the sensitivity of the foot splash.

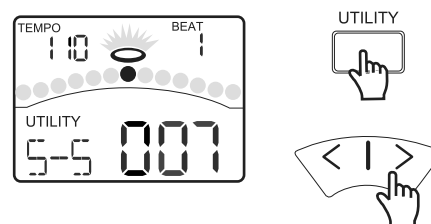

Saving Settings of Pads

After adjusting the trigger settings (sensitivity, Threshold, crosstalk, curve, rim sensitivity, splash sensitivity), you can save them into memory. In UTILITY menu, press the [SAVE] button to store all pad settings.

Note:

1. If you turn off the power without saving, you will lose the trigger setting changes you have just made.

2. These parameters affect all kits.

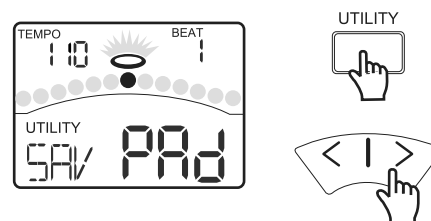

Setting the Metronome

About Click

The digital drum is equipped with a built-in metronome, which can be used by itself as a rhythm guide for practice, or in conjunction with the song playback or record functions. If the digital drum is not yet in CLICK menu, press the [CLICK] button to enter it. In CLICK menu, you can use the [<] or [>] button to adjust the parameters (as shown to the right).

Click Settings	
Time signature	0-9/2, 0-9/4, 0-9/8, 0-9/16
Interval	1-2, 3-8, 1-4, 1-8, 1-12, 1-16
Volume	0-32
Voice	1-5

Switching the Click On/Off

1. Press the [CLICK] button to start the metronome. The CLICK LED will blink accordingly. The metronome will play at the current Time signature and tempo (displayed in the left right corner of the LCD)

2. Press the [CLICK] button again to stop the metronome. The CLICK indicator will turn off.

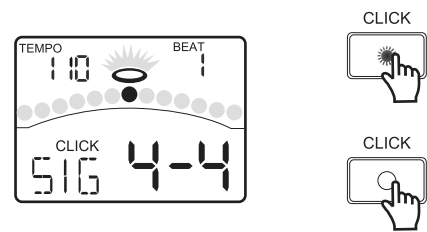

Adjusting the Click Tempo

Press the [TEMPO] button, and use the [<] and [>] buttons to adjust the current click tempo.

The current tempo always displays in the top left corner of the LCD.

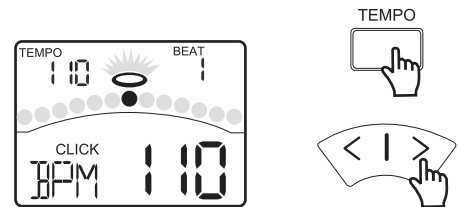

Setting the Time Signature

Press the [PAGE] button, select Click Time signature page. The display will show:

When the parameter is set to "0", such as 0-2,0-4,0-8,0-16, no accent is added to the first beat.

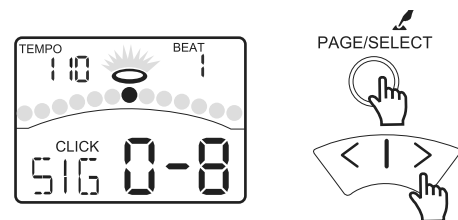

Setting the Interval

Press the [PAGE] button, select Click Interval page. The display will show:

This parameter sets how the sound plays.

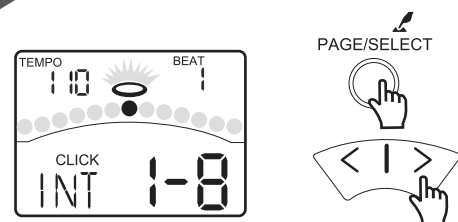

Adjusting the Click Volume

Press the [PAGE] button, select Click Volume page. The display will show:

This parameter adjust the volume of the click sound.

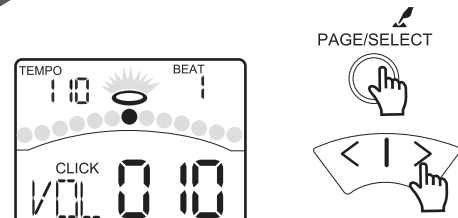

Selecting the Click Sound

Press the [PAGE] button, select Click Voice page. The display will show:

This parameter choose the sound for the click.

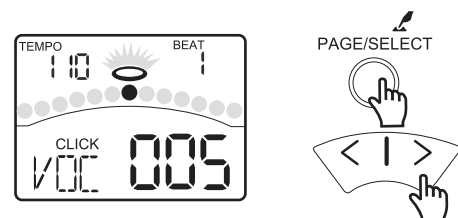

Playing Back Songs

About Songs

There are 80 preset songs in the digital drum:

- 50 Looped Patterns
- 10 Looped Percussion Patterns
- 5 Hit Songs
- 15 Tap Songs

Please refer to **Song List**. In SONG menu, you can select the song number and adjust the volume of the song's accompaniment and drum part.

Song Settings	
No.	Number(1-80)
	Accomp(0-32)
Mix	Drum(0-32)

HINT

The sounds in the tap song are played back one by one in sequence each time [START] is pressed or hitting the pad which is functioned as "pad song".

Selecting a Song

If the digital drum is not yet in SONG menu, press the [SONG] button to enter it. The SONG indicator will light up, and the LCD will display the current song number.

Press the [<] or [>] button to select a song. When holding down [>], the song number increase rapidly. When holding down [<], it decrease rapidly.

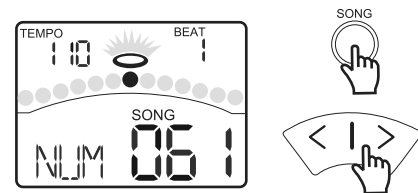

HINT

If the song number is switched while playing, the new song won't start until the end of the current bar.

Playing Back a Song

Press the [START/STOP] button to start song playback. The LCD will display the current playing beat. Press the [START/STOP] button again, stop the song during playback. During song playback in SONG menu, the PAD indicators will show which pads of the drum track is triggering.

This function can be disabled or enabled by pressing the [KICK] button while in SONG menu.

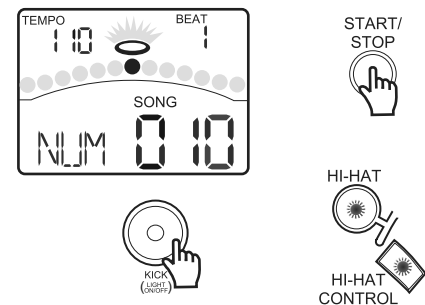

Adjusting the Accompaniment Volume

Press the [PAGE] or [SONG] button, select Song Accompaniment volume page. The display will show:

Use the [<] or [>] to adjust it. It will be restore to default value on the next power on.

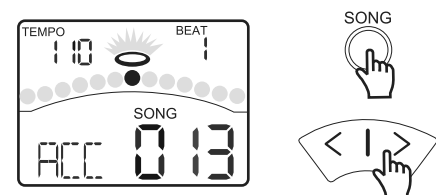

Adjusting the Drum Volume

Press the [PAGE] or [SONG] button, select Song Drum volume page. The display will show:

Use the [<] or [>] to adjust it. It will be restore to default value on the next power on.

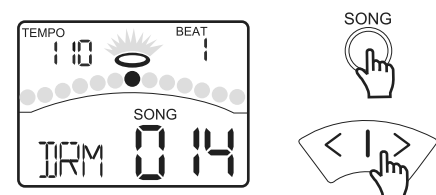

Muting the Drums in Songs

Press the [DRUM OFF] button to enable and disenable the drum mute function. When DRUM OFF is enabled, the LED will turn on.



Recording a Song

About Recording

In NORMAL mode, the digital drum allows you to quickly record your performance as you play the pads. There are two ways to start recording a new song:

- Press the [START/STOP] button
- Hit any pad

On Recording Standby, you can use the [<] or [>] button to adjust the parameters(as shown to the right).

Record Settings	
Song Number	---/1-60
Kit	1-45
Tempo	30-280
Signature	1-9/2, 1-9/4, 1-9/8, 1-9/16
Interval	1-2, 3-8, 1-4, 1-8, 1-12, 1-16
Drum Off	---/ON/OFF
Pre Count	ON/OFF

Recording Pad Performances

1. Press the [RECORD] button, enter recording standby. The [RECORD] LED will flash.
2. Press the [START/STOP] button or strike the pad. Recording will start. The RECORD LED will turn on. After Count-in, the display will show:
Now you will record your performance.
3. Press the [START/STOP] button again, or press the [RECORD] button. Stop recording, the [RECORD] LED will turn off.

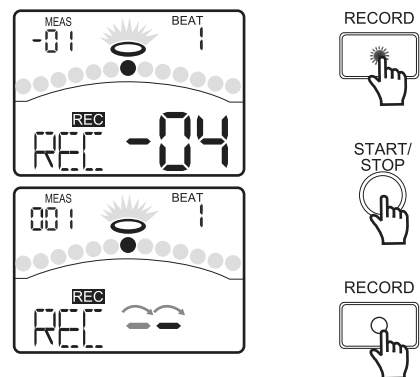

Recording Performances Accompanied with a Song

If you want to record your performance accompanied with a song, first set the parameters (Song Number and Drum off) before start to record. The display will be as shown to the right:

For details on setting, refer to Recording Standby. Recording operations are as mentioned above.

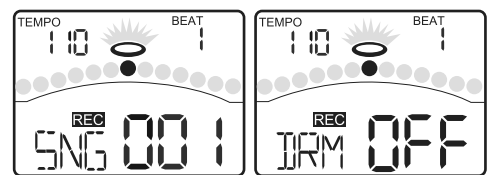

Playing Back Your Recorded Performance

Press the [PLAY] button. Play back your recording. The display will show:

Press the [PLAY] button again. Stop playing back your performance.

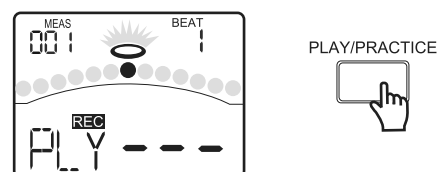

Recording Standby

Use the [PAGE] button to scroll through the various record parameters and the [<] or [>] button to adjust the value.

Page1: Setting the song accompanied or not

Page2: Selecting the drum kit that you want to record.

Page3: Setting the recording tempo

Page4: Setting the time signature

Page5: Setting the interval

Page6: Setting the drums in songs muted or not

Page7: Setting a measure count-in inserted or not before recording.



Practicing in Learning Mode

About Learning Mode

The LEARNING mode is a unique set of exercises specifically designed to help build speed, accuracy and stamina, as well as develop better drum skills.

There are 42 practices in the digital drum:

- 20 Beats (Only Snare)
- 12 Rhythms (Only Drum, from Level1-Level6)
- 10 Patterns (from Level1-Level5)

You can select appropriate patterns to practice depending on your present skills.

There are 3 states in Learning mode:

Follow me: Practice with the selected pattern

Score: Record and score your practice

Playback: Play back your recorded practice

If the digital drum is not yet in LEARNING mode, press and hold the [PAGE/SELECT] button for 1 second. The LED of LEARNING mode will turn on. The display will show:

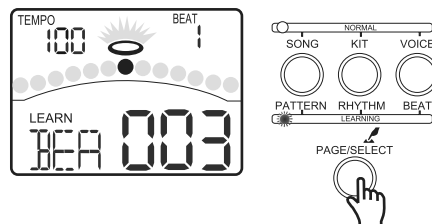

In this Learning Mode, after you press the [PRACTICE] or [START/STOP] to start practicing, your hitting accuracy will always be indicated in the middle of the display according to the current pattern.

DRAGGING:

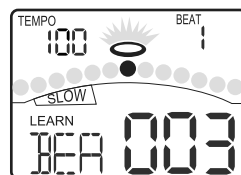

PERFECT:

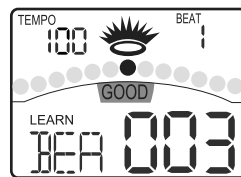

RUSHING:

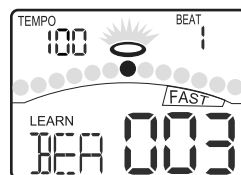

Practicing with Beats

If the digital drum is not yet in BEAT menu, press the [BEAT] button to enter it. You can adjust the parameters (as shown to the right).

1. Press the [<] or [>] button to select the beat.
2. Press the [PRACTICE] button to listen to the beat and follow it. Press it again to stop the beat.
3. Press the [BEAT] or [PAGE] button to select the Beat Drum volume page. Press the [<] or [>] button to adjust the drum volume of the beat.

Beat	
Number	1-20
Drum Volume	0-32

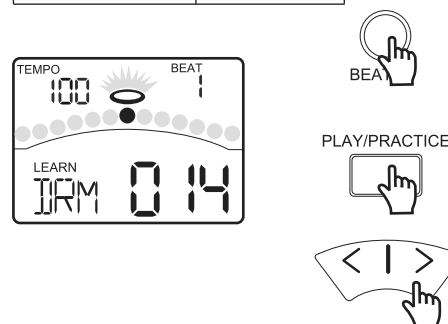

Practicing with Rhythms

If the digital drum is not yet in RHYTHM menu, press the [RHYTHM] button to enter it. You can adjust the parameters (as shown to the right).

1. Press the [<] or [>] button to select the rhythm.
2. Press the [PRACTICE] button to listen to the rhythm and follow it. Press it again to stop the rhythm.
3. Press the [RHYTHM] or [PAGE] button to select the Rhythm Level page. Press the [<] or [>] button to select the level of the rhythm.
4. Press the [RHYTHM] or [PAGE] button to select the Rhythm Drum Volume page. Press the [<] or [>] button to adjust the drum volume of the rhythm.

Rhythm	
Number	1-12
Level	1-6
Drum Volume	0-32

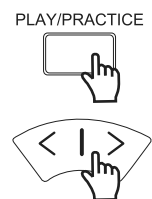
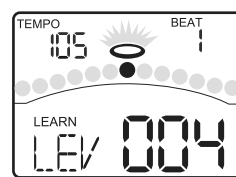
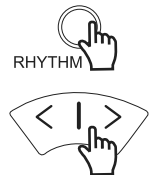
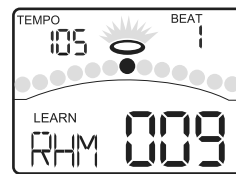

Practicing with Patterns

If the digital drum is not yet in Pattern menu, press the [PATTERN] button to enter it. You can adjust the parameters (as shown to the right).

1. Press the [<] or [>] button to select the pattern.
2. Press the [PRACTICE] button to listen to the pattern and follow it. Press it again to stop the pattern.
3. Press the [PATTERN] or [PAGE] button to select the Pattern Level page. Press the [<] or [>] button to select the level of the pattern.
4. Press the [PATTERN] or [PAGE] button to select the Pattern Accompany Volume page. Press the [<] or [>] button to adjust the accompaniment volume of the pattern.
5. Press the [PATTERN] or [PAGE] button to select the Pattern Drum Volume page. Press the [<] or [>] button to adjust the drum volume of the pattern.

Pattern	
Number	1-10
Level	1-5
Accompany Volume	0-32
Drum Volume	0-32

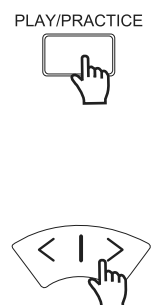
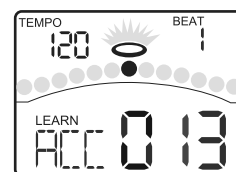
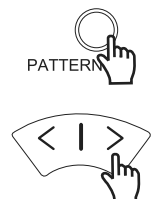
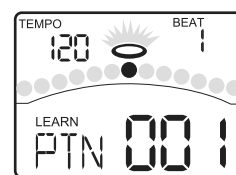

Practicing in Learning Mode

Recording and Scoring Your Practice

1. Press the [START/STOP] button, you can enter the score state. A measure count-in will be inserted before playing back the pattern so that you can practice in good time. When playing back the pattern, your performance will be recorded automatically. When finished playback, the digital drum will score your practice automatically.

The display will show the score for 3 seconds.

2. Press the [START/STOP] button again to stop playing back the pattern and recording your practice during the playback

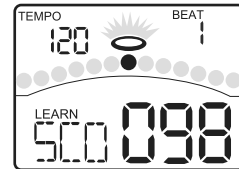
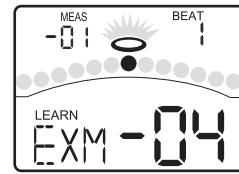

Playing Back Your Recorded Practice

1. Press and hold the [PLAY/PRACTICE] button for 2 seconds, you can enter the playback state. The display will show: You will listen to your recorded practice.
2. Press the [PLAY/PRACTICE] button again. Stop playing back the recorded practice.

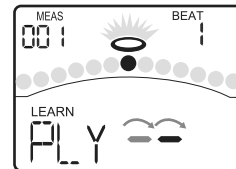

Making the Settings for MIDI

About MIDI

MIDI (Musical Instrument Digital Interface) is a standard that allows performance data and other information to be exchanged among electronic musical instruments and computers. With a MIDI cable connecting MIDI connectors equipped device, you can play multiple instruments with a single keyboard, have multiple instruments perform in ensemble, program the settings to change kits automatically to match the performance as the song progress, and more.

MIDI Connection

MIDI IN: This terminal receives MIDI data from an external MIDI device.

MIDI OUT: This terminal transmits data from the digital drum to other MIDI devices.

USB Connection

The USB connector allows you to connect the digital drum directly to your computer. It can be connected without installing a driver in Windows XP/Vista/Win7 or MAC OSX environments. The digital drum will be recognized as a "USB Audio device" to receive and transmit MIDI messages through a single USB cable. The USB port is used only for MIDI messages (MIDI via USB)

Note:

When the USB port is connected to a computer, all MIDI messages will be received and transmitted via USB.

Making the MIDI Settings

If the digital drum is not yet in UTILITY menu, press The [UTILITY] button to enter it. Press the [PAGE] or [UTILITY] button, select Local mode pages. The display will show:

Press the [<] or [>] button, set local mode to ON or OFF.

Local Mode

Local OFF: The pads and internal sequencer are disconnected from the digital drum's internal sound generator. Striking the pads does not cause sound to be produced by the internal sound generator.

Local ON: The pads and internal sequencer are connected to the digital drum's internal sound generator. Sounds are produced by the internal sound generator when the pads are struck.

GM Mode

Press the [PAGE] or [UTILITY] button, select GM mode pages.

The display will show:

Press the [<] or [>] button, set GM mode to ON or OFF.

Refer to Using the Digital Drum as a Sound Module.

Sync Mode

Press the [START/STOP] button to start or stop songs playback, the digital drum will transmit the MIDI system real-time Message: FA or FC.

MIDI Settings	
Local on/off	ON/OFF
GM on/off	ON/OFF

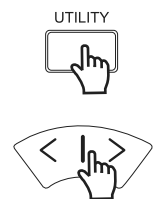
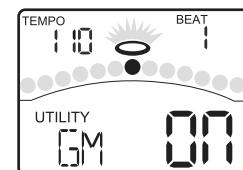
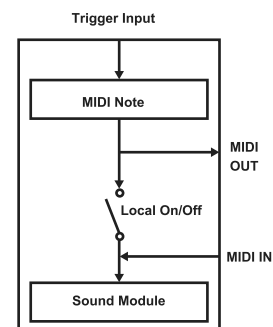
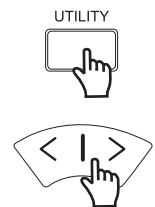
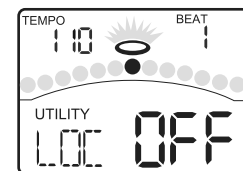

Making the Settings for MIDI

Connecting with an External Sound Device

The digital drum transmission channel for the drum kit is fixed to Channel 10. It will output MIDI data generated by the triggers when hitting the pads or stepping on the Hi-Hat control pedal (Note ON/OFF, and Foot messages). Song playback data and metronome notes are not transmitted.

Recording Your Performance to an External Sequencer

1. Connect the MIDI OUT of the digital drum to the MIDI IN of your sequencer, and the MIDI OUT of your sequencer to the MIDI IN of the digital drum. If you are using a software sequencer on a computer, you can simply connect the USB port of the digital drum to a USB port of your computer using a single USB A-B cable.
2. Setup the active track of your sequencer on Channel 10. Activate RECORD on your sequencer.
3. Play the pads of your digital drum.
4. Stop recording. Locate your sequencer to the start of your recording.
5. Playback the recorded sequencer.

Setting MIDI Note Number to be Transmitted/Received by Each Pad

Each drum kit can have its own set of MIDI note to be transmitted/received by each pad, useful for advanced purpose. Normally, you'll never need to change them, but if you want to change, please follow these steps:

1. Press the [VOICE] button in NORMAL mode, enter the VOICE menu.
2. Press the [PAGE] or [VOICE] button, select Pad MIDI Note page.
3. Press the [<] or [>] button, change the MIDI Note Number for each pad. Hit the pad you wish to set or press the related Pad Select button.
4. Press the [SAVE] button twice to save to user kit.

Trigger	MIDI Note	Trigger	MIDI Note	Trigger	MIDI Note	Trigger	MIDI Note	Trigger	MIDI Note
Kick	36	Tom2	45	Tom4 R	39	Crash1 R	55	Hi-Hat HO	23
Snare	38	Tom2 R	47	Ride	51	Crash2	57	Hi-Hat C	42
Snare R	40	Tom3	43	Ride R	53	Crash2 R	52	Hi-Hat P	44
Tom1	48	Tom3 R	58	Crash1	49	Hi-Hat O	46	Splash	21
Tom1 R	50	Tom4	41						

Using the Digital Drum as a Sound Module

Connecting an external keyboard or sequencer to the MIDI Input allows you to use the digital drum as a multi-part, polyphonic sound module to play various instrument parts in addition to your drums (for instance, Piano on Channel 1, Bass on Channel 2, Strings on Channel 3, etc). The voices on each MIDI channel are selected using MIDI Program Change messages (refer to **GM Backing Instrument List**).



The MIDI system in the digital drum has 16 reception channels numbered from 1-16. Each of the channels is responsible for a voice. When the instrument receives MIDI information from an external device, the active channel is determined by the control message. Channel 10 is reserved for Drums. The digital drum has two options for Channel 10: GM ON or OFF, as selected in MIDI UTILITY menu.

- When GM Mode is ON, Channel 10 will play the GM percussion kits.
- When GM Mode is OFF, Channel 10 will play the digital drum internal kits.

Note:

For more information on received MIDI messages, refer to MIDI implementation chart.

Prompt Messages

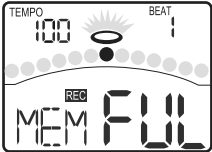
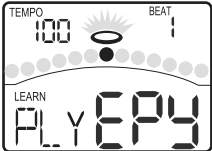
Display	Meaning	Action
	Resetting the digital drum is failed.	Please call the distributor, maybe it need repair.
	There isn't data in the digital drum's memory.	Please record your performance, and then play it.
	There is full of data in the digital drum's memory. You can not record any data.	If you want to record another song, please restart recording and replace it.
	You didn't record your practice in the Learning mode.	Please press the [START/STOP] button to score your practice, and then play back your practice.

Troubleshooting

	Possible Cause and Solution
No Sound	<ol style="list-style-type: none"> 1) Rotate the [VOLUME] knob to be sure that the volume isn't down. 2) To be sure that Local Mode should be set to 漏N?
No Sound from Pads	<ol style="list-style-type: none"> 1) To be sure that the pad is connected correctly. 2) To be sure not set the volume of the pad to 0.
No Click Sound	<ol style="list-style-type: none"> 1) To be sure not set the volume of the click to 0.
Sound is Distorted	<ol style="list-style-type: none"> 1) Turn down the volume.

Specifications

Maximum Polyphony

64

Drum kits

45 (29 Preset Kits + 16 User Kits)

General MIDI Kits

11 GM Kits

Drum Instruments

400 (Drums, Percussion, SFX)
7 Hi-Hat Combos

Effect

Reverb, 3 Band Equalizer

Sequencer**Normal**

Song 80

Learning

Beat 20, Rhythm 12, Pattern 10

Resolution

120 ticks per quarter note

Recording Method

Real-time

Maximum Note Storage

approx. 1600 Notes

Tempo

30~280

Display

Backlit Segment LCD

Connectors

9 Trigger Input Jack, Phone Jack(1/8", stereo), Aux In Jack(1/8", stereo),
2 External Trigger Input Jack(1/4", Tom4, Crash2),
Output(1/4", L/Mono, R), USB, MIDI IN, MIDI OUT

Control Buttons

Power on/off switch, Volume, Start/Stop, Save, Song, Kit, Voice, Page/Select, INC/DEC, Click, Drum off, Record, Tempo, Utility, Play/Practice

Pad Select Buttons

12 Pad Select Buttons

Power Supply

DC 9V

Dimensions

147.1(W) × 183.3(H) × 111.7(D)mm

Weight

0.5 kg

Drum Kit List

NO.	PRESET KIT	NO.	PRESET KIT
1	Acoustic	25	Tabla
2	Standard 1	26	Latin
3	Standard 2	27	808
4	Funk 1	28	Teckno 2
5	Funk 2	29	DJ
6	Fusion	30	Acoustic
7	Camco	31	Standard 1
8	Brush	32	Standard 2
9	Room	33	Funk 1
10	Rock	34	Funk 2
11	Pop Rock	35	Fusion
12	Jazz	36	Camco
13	Jazz Brush	37	Brush
14	Timpani	38	Room
15	Songo	39	Rock
16	1971's	40	Pop Rock
17	Disco	41	Jazz
18	TR606	42	Jazz Brush
19	909	43	Timpani
20	HipHop 1	44	Songo
21	HipHop 2	45	1971's
22	Electronic 1		
23	Electronic 2		
24	Teckno 1		

Drum Instrument List

No.	Name
Acoustic Kick	
1	Standard Kick 1
2	Standard Kick 2
3	Classic Kick 1
4	Classic Kick 2
5	Rock Kick 1
6	Rock Kick 2
7	Rock Kick 3
8	Room Kick 1
9	Room Kick 2
10	Jazz Kick 1
11	Jazz Kick 2
12	Big Band Kick 1
13	Big Band Kick 2
14	Camco Kick 1
15	Camco Kick 2
16	Funk Kick 1
17	Funk Kick 2
18	Funk Kick 3
19	HipHop Kick 1
20	HipHop Kick 2
21	HipHop Kick 3
22	HipHop Kick 4
23	1969 Kick
24	1971 Kick
25	1976 Kick
26	Power Kick
27	R&B Kick
28	Voice Kick
29	Acoustic Kick
Electronic Kick	
30	Orchestra Kick
31	House Kick 1
32	House Kick 2
33	House Kick 3
34	House Kick 4
35	Step Kick
36	Teckno Kick
37	Drum & Bass Kick
38	Junkyard Kick
39	Noise Kick
40	Industry Kick
41	Lowfi Kick
42	Disco Kick
43	808 Kick
44	909 Kick
45	Electronic Kick 1
46	Electronic Kick 2
47	Electronic Kick 3
48	Electronic Kick 4
49	Electronic Kick 5
50	Electronic Kick 6
51	Electronic Kick 7
Acoustic Snare	
52	Standard Snare
53	Standard Snare Rim

54	Classic Snare 1
55	Classic Snare Rim 1
56	Classic Snare 2
57	Classic Snare Rim 2
58	Acoustic Snare
59	Acoustic Snare Rim
60	Rock Snare 1
61	Rock Snare Rim 1
62	Rock Snare 2
63	Rock Snare 3
64	Room Snare 1
65	Room Snare 2
66	Room Snare 3
67	Steel Snare
68	Steel Snare Rim
69	Jazz Snare 1
70	Jazz Snare Rim 1
71	Jazz Snare 2
72	Jazz Snare Rim 2
73	Jazz Latin Snare
74	Big Band Snare
75	Camco Snare
76	Camco Snare Rim
77	Brush Snare 1
78	Brush Snare 2
79	Brush Snare Rim
80	Funk Snare
81	Funk Stick
82	Funk Band Snare
83	Funk Band Snare Rim
84	Funk Band Snare Stick
85	Fusion Snare
86	Fusion Snare Stick
87	Snare Stick
88	Power Snare
89	HipHop Snare 1
90	HipHop Snare 2
91	1969 Snare
92	1969 Snare Rim
93	1971 Snare
94	1971 Snare Rim
95	1976 Snare
96	1976 Snare Rim
Electronic Snare	
97	House Snare 1
98	House Snare 2
99	House Snare 3
100	Teckno Snare 1
101	Teckno Snare 2
102	808 Snare
103	909 Snare
104	Drum & Bass Snare 1
105	Drum & Bass Snare 2
106	TR606 Snare
107	Electronic Snare 1
108	Electronic Snare 2
109	Electronic Snare 3

110	Electronic Snare 4
111	Electronic Snare 5
112	Electronic Snare 6
113	Electronic Snare 7
114	Electronic Snare 8
Acoustic Tom	
115	Classic Tom 1
116	Classic Tom 2
117	Classic Tom 3
118	Classic Tom 4
119	Classic Tom 5
120	Classic Tom 6
121	Standard Tom 1
122	Standard Tom 2
123	Standard Tom 3
124	Standard Tom 4
125	Standard Tom 5
126	Standard Tom 6
127	Camco Tom 1
128	Camco Tom 2
129	Camco Tom 3
130	Camco Tom 4
131	Camco Tom 5
132	Camco Tom 6
133	Rock Tom 1
134	Rock Tom 2
135	Rock Tom 3
136	Rock Tom 4
137	Rock Tom 5
138	Rock Tom 6
139	Room Tom 1
140	Room Tom 2
141	Room Tom 3
142	Room Tom 4
143	Room Tom 5
144	Room Tom 6
145	Funk Tom 1
146	Funk Tom 2
147	Funk Tom 3
148	Funk Tom 4
149	Funk Tom 5
150	Funk Tom 6
151	Fusion Tom 1
152	Fusion Tom 2
153	Fusion Tom 3
154	Fusion Tom 4
155	Fusion Tom 5
156	Fusion Tom 6
157	1969 Tom 1
158	1969 Tom 2
159	1969 Tom 3
160	1969 Tom 4
161	1971 Tom 1
162	1971 Tom 2
163	1971 Tom 3
164	1971 Tom 4
165	1976 Tom 1

166	1976 Tom 2
167	1976 Tom 3
168	1976 Tom 4
169	HipHop Tom 1
170	HipHop Tom 2
171	HipHop Tom 3
172	HipHop Tom 4
173	HipHop Tom 5
174	HipHop Tom 6
175	Jazz Tom 1
176	Jazz Tom 2
177	Jazz Tom 3
178	Jazz Tom 4
179	Jazz Tom 5
180	Jazz Tom 6
181	Brush Tom 1
182	Brush Tom 2
183	Brush Tom 3
184	Brush Tom 4
185	Brush Tom 5
186	Brush Tom 6
187	Tom Rim 1
188	Tom Rim 2
189	Tom Rim 3
190	Tom Rim 4
191	Timpani 1
192	Timpani 2
193	Timpani 3
194	Timpani 4
195	TR606 Tom 1
196	TR606 Tom 2
197	TR606 Tom 3
198	TR606 Tom 4
199	TR606 Tom 5
200	TR606 Tom 6
201	808 Tom 1
202	808 Tom 2
203	808 Tom 3
204	808 Tom 4
205	808 Tom 5
206	808 Tom 6
207	Electronic Tom 1
208	Electronic Tom 2
209	Electronic Tom 3
210	Electronic Tom 4
211	Electronic Tom 5
212	Electronic Tom 6
213	909 Tom 1
214	909 Tom 2
215	909 Tom 3
216	909 Tom 4
Ride	
217	Classic Ride
218	Classic Ride Rim
219	Acoustic Ride
220	Acoustic Ride Rim
221	Standard 22" Ride

Drum Instrument List

222	Standard 22" Ride Rim
223	Brush Ride
224	Brush Ride Rim
225	Rock Ride
226	Clean Pop Ride
227	Flat Ride
228	60's Ride
229	808 Ride
Crash	
230	Classic Crash 1
231	Classic Crash Rim 1
232	Classic Crash 2
233	Classic Crash Rim 2
234	Standard Crash 1
235	Standard Crash Rim 1
236	Standard Crash 2
237	Standard Crash 3
238	Rock Crash 1
239	Rock Crash 2
240	Splash
241	Brush Crash
242	China
243	Orchestra Crash
244	HipHop Crash
245	808 Crash
246	606 Crash
247	Electronic Crash
Hi-hat	
248	Standard Hi-hat Open
249	Pop Hi-hat Open
250	Rock Hi-hat Open
251	Jazz Hi-hat Open
252	Electronic Hi-hat Open
253	808 Hi-hat Open
254	House Hi-hat Open
255	Standard Half Open
256	Pop Half Open
257	Rock Half Open
258	Jazz Half Open
259	Standard Hi-hat Close
260	Pop Hi-hat Close
261	Rock Hi-hat Close
262	Jazz Hi-hat Close
263	Electronic Hi-hat Close
264	808 Hi-hat Close
265	House Hi-hat Close
266	Standard Hi-hat Pedal
267	Pop Hi-hat Pedal
268	Rock Hi-hat Pedal
269	Jazz Hi-hat Pedal
270	Electronic Hi-hat Pedal
271	808 Hi-hat Pedal
272	House Hi-hat Pedal
273	Standard Hi-hat Splash
274	Rock Hi-hat Splash
Percussion	
275	Metronome Bell

276	Metronome Click
277	Scratch
278	Scratch Push
279	DJ FX
280	High Q Zap
281	Ding Bell
282	Finger Snaps
283	Standard Clap
284	Tambourine
285	Vibraslap
286	Agogo Low
287	Agogo High
288	Bell Tree
289	Bongo High
290	Bongo Low
291	Shaker
292	Conga Slap High
293	Conga Slap Mid
294	Conga Low
295	Open Conga
296	Conga Slap
297	Cowbell
298	Timbale High
299	Timbale Low
300	Timpani High
301	Timpani Low
302	Open Tabla High
303	Open Tabla Low
304	Slap Tabla
305	Mute Slap Tabla
306	Cabasa
307	Maracas
308	Short Whistle
309	Short Guiro
310	Long Guiro
311	Claves
312	Wood Block
313	Muted Cuica
314	Open Cuica
315	Muted Triangle
316	Open Triangle
317	Sleigh Bells
318	Wind Chimes
319	Castanets
320	Muted Surdo
321	Open Surdo
322	Lotus Drum
323	Cowbell 1
324	Cowbell 2
325	Cowbell 3
326	Cowbell 4
327	Cowbell 5
328	Cowbell 6
329	Cowbell 7
330	Cowbell 8
331	Cowbell 9
332	Cowbell 10

333	Cowbell 11
334	Tabla 1
335	Tabla 2
336	Tabla 3
337	Tabla 4
338	Tabla 5
339	Tabla 6
340	Da Gu 1
341	Da Gu 2
342	Zhu Ban
343	Nan Bang
344	Da Mu Yu
345	Mu Yu 1
346	Mu Yu 2
347	Mu Yu 3
348	Mu Yu 4
349	Pai Gu 1
350	Pai Gu 2
351	Pai Gu 3
352	Mang Luo 1
353	Mang Luo 2
354	Mang Luo 3
355	Da Luo 1
356	Da Luo 2
357	Da Po 1
358	Da Po 2
359	Xiao Po
360	Xiao Luo
361	Ten Luo
362	Peng Lin
363	Gou Luo
364	DJ 1
365	DJ 2
366	DJ 3
367	DJ 4
368	DJ 5
369	DJ 6
370	DJ 7
371	DJ 8
372	DJ 9
373	DJ 10
374	One
375	Two
376	Three
377	Four
378	Five
379	Six
380	Seven
381	Eight
382	Nine
383	Metronome Bell
384	Metronome Click
385	Clave Click 1
386	Clave Click 2
387	Stick Click 1
388	Stick Click 2
389	Cow Click 1

390	Cow Click 2
391	Fm Click 1
392	Fm Click 2
FX	
393	FX 1
394	FX 2
395	FX 3
396	FX 4
397	FX 5
398	FX 6
399	FX 7
400	FX 8
HI-HAT COMBINATIONS	
1	Standard
2	Pop
3	Rock
4	Jazz
5	Electronic
6	808
7	House

GM Drum Kit List

Note No.	Standard 1 (bank 0)	Standard 2 (bank 4)	Room (bank 8)	Rock (bank 16)
27-D#1	High Q	<-	<-	<-
28-E1	Slap	<-	<-	<-
29-F1	Scratch Push	<-	<-	<-
30-F#1	Scratch Pull	<-	<-	<-
31-G1	Sticks	<-	<-	<-
32-G#1	Square Click	<-	<-	<-
33-A1	Metronome Click	<-	<-	<-
34-A#1	Metronome Bell	<-	<-	<-
35-B1	Acoustic Bass Drum	<-	Room Bass Drum 1	Rock Bass Drum 1
36-C2	Standard 1 Bass Drum	Standard 2 Bass Drum	Room Bass Drum 2	Rock Bass Drum 2
37-C#2	Side Stick	<-	<-	<-
38-D2	Standard 1 Snare	Standard 2 Snare	Room Snare	Rock Snare
39-D#2	Hand Clap	<-	<-	<-
40-E2	Standard 1 Snare Rim	Standard 2 Snare Rim	Room Snare Rim	Rock Snare Rim
41-F2	Standard 1 Tom 6	Standard 2 Tom 6	Room Tom 6	Rock Tom 6
42-F#2	Standard 1 Hi-hat Close	Standard 2 Hi-hat Close	Room Hi-hat Close	Rock Hi-hat Close
43-G2	Standard 1 Tom 5	Standard 2 Tom 5	Room Tom 5	Rock Tom 5
44-G#2	Standard 1 Hi-hat Pedal	Standard 2 Hi-hat Pedal	Room Hi-hat Pedal	Rock Hi-hat Pedal
45-A2	Standard 1 Tom 4	Standard 2 Tom 4	Room Tom 4	Rock Tom 4
46-A#2	Standard 1 Hi-hat Open	Standard 2 Hi-hat Open	Room Hi-hat Open	Rock Hi-hat Open
47-B2	Standard 1 Tom 3	Standard 2 Tom 3	Room Tom 3	Rock Tom 3
48-C3	Standard 1 Tom 2	Standard 2 Tom 2	Room Tom 2	Rock Tom 2
49-C#3	Standard 1 Crash 1	Standard 2 Crash 1	Room Crash 1	Rock Crash 1
50-D3	Standard 1 Tom 1	Standard 2 Tom 1	Room Tom 1	Rock Tom 1
51-D#3	Standard 1 Ride	Standard 2 Ride	Room Ride	Rock Ride
52-E3	Chinese Cymbal 1	<-	<-	<-
53-F3	Ride Bell	<-	Room Ride Bell	Rock Ride Bell
54-F#3	Tambourine	<-	<-	<-
55-G3	Splash Cymbal	<-	Room Splash Cymbal	Rock Splash Cymbal
56-G#3	Standard 1 Cowbell	Standard 2 Cowbell	Room Cowbell	Rock Cowbell
57-A3	Standard 1 Crash 2	Standard 2 Crash 2	Room Crash 2	Rock Crash 2
58-A#3	Vibra-slap	<-	<-	<-
59-B3	Ride Cymbal	<-	<-	<-
60-C4	Hi Bongo	<-	<-	<-
61-C#4	Low Bongo	<-	<-	<-
62-D4	Mute Hi Conga	<-	<-	<-
63-D#4	Open Hi Conga	<-	<-	<-
64-E4	Low Conga	<-	<-	<-
65-F4	High Timbale	<-	<-	<-
66-F#4	Low Timbale	<-	<-	<-
67-G4	High Agogo	<-	<-	<-
68-G#4	Low Agogo	<-	<-	<-
69-A4	Cabasa	<-	<-	<-
70-A#4	Maracas	<-	<-	<-
71-B4	Short Whistle	<-	<-	<-
72-C5	Long Whistle	<-	<-	<-
73-C#5	Short Guiro	<-	<-	<-
74-D5	Long Guiro	<-	<-	<-
75-D#5	Claves	<-	<-	<-
76-E5	Hi Wood Block	<-	<-	<-
77-F5	Low Wood Block	<-	<-	<-
78-F#5	Mute Cuica	<-	<-	<-
79-G5	Open Cuica	<-	<-	<-
80-G#5	Mute Triangle	<-	<-	<-
81-A5	Open Triangle	<-	<-	<-
82-A#5	Shaker	<-	<-	<-
83-B5	Jingle Bell	<-	<-	<-
84-C6	Bell Tree	<-	<-	<-
85-C#6	Castanets	<-	<-	<-
86-D6	Mute Surdo	<-	<-	<-
87-D#6	Open Surdo	<-	<-	<-

GM Drum Kit List

Note No.	Funk (bank 17)	Electronic (bank 24)	808 (bank 25)	House (bank 28)
27-D#1	<-	<-	<-	<-
28 E1	<-	<-	<-	<-
29-F1	<-	<-	<-	<-
30-F#1	<-	<-	<-	<-
31-G1	<-	<-	<-	<-
32-G#1	<-	<-	<-	<-
33-A1	<-	<-	<-	<-
34-A#1	<-	<-	<-	<-
35-B1	Funk Bass Drum 1	Electronic Bass Drum 1	808 Bass Drum 1	House Bass Drum 1
36-C2	Funk Bass Drum 2	Electronic Bass Drum 2	808 Bass Drum 2	House Bass Drum 2
37-C#2	<-	<-	<-	<-
38-D2	Funk Snare	Electronic Snare	808 Snare	House Snare
39-D#2	<-	<-	<-	House Hand Clap
40-E2	Funk Snare Rim	Electronic Snare Rim	808 Snare Rim	House Snare Rim
41-F2	Funk Tom 6	Electronic Tom 6	808 Tom 6	House Tom 6
42-F#2	Funk Hi-hat Close	Electronic Hi-hat Close	808 Hi-hat Close	House Hi-hat Close
43-G2	Funk Tom 5	Electronic Tom 5	808 Tom 5	House Tom 5
44-G#2	Funk Hi-hat Pedal	Electronic Hi-hat Pedal	808 Hi-hat Pedal	House Hi-hat Pedal
45-A2	Funk Tom 4	Electronic Tom 4	808 Tom 4	House Tom 4
46-A#2	Funk Hi-hat Open	Electronic Hi-hat Open	808 Hi-hat Open	House Hi-hat Open
47-B2	Funk Tom 3	Electronic Tom 3	808 Tom 3	House Tom 3
48-C3	Funk Tom 2	Electronic Tom 2	808 Tom 2	House Tom 2
49-C#3	Funk Crash 1	<-	808 Crash 1	<-
50-D3	Funk Tom 1	Electronic Tom 1	808 Tom 1	House Tom 1
51-D#3	Funk Ride	<-	<-	<-
52-E3	<-	<-	<-	<-
53-F3	<-	<-	<-	<-
54-F#3	<-	<-	<-	<-
55-G3	<-	<-	<-	<-
56-G#3	<-	<-	<-	<-
57-A3	Funk Crash 2	<-	808 Crash 2	<-
58-A#3	<-	<-	<-	<-
59-B3	<-	<-	<-	<-
60-C4	<-	<-	<-	<-
61-C#4	<-	<-	<-	<-
62-D4	<-	<-	808 Mute Hi Conga	<-
63-D#4	<-	<-	808 Open Hi Conga	<-
64-E4	<-	<-	808 Low Conga	<-
65-F4	<-	<-	<-	<-
66-F#4	<-	<-	<-	<-
67-G4	<-	<-	<-	<-
68-G#4	<-	<-	<-	<-
69-A4	<-	<-	<-	<-
70-A#4	<-	<-	808 Maracas	<-
71-B4	<-	<-	<-	<-
72-C5	<-	<-	<-	<-
73-C#5	<-	<-	<-	<-
74-D5	<-	<-	<-	<-
75-D#5	<-	<-	808 Claves	<-
76-E5	<-	<-	<-	<-
77-F5	<-	<-	<-	<-
78-F#5	<-	<-	<-	<-
79-G5	<-	<-	<-	<-
80-G#5	<-	<-	<-	<-
81-A5	<-	<-	<-	<-
82-A#5	<-	<-	<-	<-
83-B5	<-	<-	<-	<-
84-C6	<-	<-	<-	<-
85-C#6	<-	<-	<-	<-
86-D6	<-	<-	<-	<-
87-D#6	<-	<-	<-	<-

GM Drum Kit List

Note No.	Jazz (bank 32)	Brush (bank 40)	Orchestra (bank 48)
27—D#1	<-	<-	Concert Hi-hat Close
28 E1	<-	<-	Concert Hi-hat Pedal
29—F1	<-	<-	Concert Hi-hat Open
30—F#1	<-	<-	Concert Ride
31—G1	<-	<-	<-
32—G#1	<-	<-	<-
33—A1	<-	<-	<-
34—A#1	<-	<-	<-
35—B1	Jazz Bass Drum 1	Brush Bass Drum 1	Concert Bass Drum 1
36—C2	Jazz Bass Drum 2	Brush Bass Drum 2	Concert Bass Drum 2
37—C#2	<-	<-	<-
38—D2	Jazz Snare	Brush Snare	Concert Snare 1
39—D#2	<-	<-	Castanets
40—E2	Jazz Snare Rim	Brush Snare Rim	Concert Snare 2
41—F2	Jazz Tom 6	Brush Tom 6	Timpani F
42—F#2	Jazz Hi-hat Close	<-	Timpani F#
43—G2	Jazz Tom 5	Brush Tom 5	Timpani G
44—G#2	Jazz Hi-hat Pedal	<-	Timpani G#
45—A2	Jazz Tom 4	Brush Tom 4	Timpani A
46—A#2	Jazz Hi-hat Open	<-	Timpani A#
47—B2	Jazz Tom 3	Brush Tom 3	Timpani B
48—C3	Jazz Tom 2	Brush Tom 2	Timpani C
49—C#3	<-	Brush Crash 1	Timpani C#
50—D3	Jazz Tom 1	Brush Tom 1	Timpani D
51—D#3	Jazz Ride	Brush Ride	Timpani D#
52—E3	<-	<-	Timpani E
53—F3	<-	<-	Timpani F
54—F#3	<-	<-	<-
55—G3	<-	<-	<-
56—G#3	<-	<-	<-
57—A3	Chinese Cymbal 2	Brush Crash 2	Concert Crash 1
58—A#3	<-	<-	<-
59—B3	<-	<-	Concert Crash 2
60—C4	<-	<-	<-
61—C#4	<-	<-	<-
62—D4	<-	<-	<-
63—D#4	<-	<-	<-
64—E4	<-	<-	<-
65—F4	<-	<-	<-
66—F#4	<-	<-	<-
67—G4	<-	<-	<-
68—G#4	<-	<-	<-
69—A4	<-	<-	<-
70—A#4	<-	<-	<-
71—B4	<-	<-	<-
72—C5	<-	<-	<-
73—C#5	<-	<-	<-
74—D5	<-	<-	<-
75—D#5	<-	<-	<-
76—E5	<-	<-	<-
77—F5	<-	<-	<-
78—F#5	<-	<-	<-
79—G5	<-	<-	<-
80—G#5	<-	<-	<-
81—A5	<-	<-	<-
82—A#5	<-	<-	<-
83—B5	<-	<-	<-
84—C6	<-	<-	<-
85—C#6	<-	<-	<-
86—D6	<-	<-	<-
87—D#6	<-	<-	<-

GM Backing Instrument List

PIANO

- 1 Acoustic Grand Piano
- 2 Bright Acoustic Piano
- 3 Electric Grand Piano
- 4 Honky-Tonk Piano
- 5 E.Piano 1
- 6 E.Piano 2
- 7 Harpsichord
- 8 Clavi

MALLET

- 9 Celesta
- 10 Glockenspiel
- 11 Music Box
- 12 Vibraphone
- 13 Marimba
- 14 Xylophone
- 15 Tubular Bells
- 16 Dulcimer

ORGAN

- 17 Drawbar Organ
- 18 Percussive Organ
- 19 Rock Organ
- 20 Church Organ
- 21 Reed Organ
- 22 Accordion
- 23 Harmonica
- 24 Tango Accordion

GUITAR

- 25 Nylon Guitar
- 26 Steel Guitar
- 27 Jazz Guitar
- 28 Clean Guitar
- 29 Muted Guitar
- 30 Overdriven Guitar
- 31 Distortion Guitar
- 32 Guitar Harmonics

BASS

- 33 Acoustic Bass
- 34 Finger Bass
- 35 Pick Bass
- 36 Fretless Bass
- 37 Slap Bass 1
- 38 Slap Bass 2
- 39 Synth Bass 1
- 40 Synth Bass 2

STRINGS

- 41 Violin
- 42 Viola

- 43 Cello
- 44 Contrabass
- 45 Tremolo Strings
- 46 Pizzicato Strings
- 47 Orchestral Harp
- 48 Timpan

STRINGS ENSEMBLE

- 49 Strings Ensemble 1
- 50 Strings Ensemble 2
- 51 Synth Strings 1
- 52 Synth Strings 2
- 53 Choir Aahs
- 54 Voice Oohs
- 55 Synth Voice
- 56 Orchestra Hit

BRASS

- 57 Trumpet
- 58 Trombone
- 59 Tuba
- 60 Muted Trumpet
- 61 French Horn
- 62 Brass Section
- 63 Synth Brass 1
- 64 Synth Brass 2

REED

- 65 Soprano Sax
- 66 Alto Sax
- 67 Tenor Sax
- 68 Baritone Sax
- 69 Oboe
- 70 English Horn
- 71 Bassoon
- 72 Clarinet

PIPE

- 73 Piccolo
- 74 Flute
- 75 Recorder
- 76 Pan Flute
- 77 Blown Bottle
- 78 Shakuhachi
- 79 Whistle
- 80 Ocarina

LEAD

- 81 Lead1 (square)
- 82 Lead2 (sawtooth)
- 83 Lead3 (calliope)
- 84 Lead4 (chiff)
- 85 Lead5 (charang)

- 86 Lead6 (voice)
- 87 Lead7 (fifths)
- 88 Lead8 (bass & Lead)

PAD

- 89 Pad1 (newage)
- 90 Pad2 (warm)
- 91 Pad3 (Polysynth)
- 92 Pad4 (choir)
- 93 Pad5 (bowed)
- 94 Pad6 (metallic)
- 95 Pad7 (halo)
- 96 Pad8 (sweep)

EFFECTS

- 97 FX1 (rain)
- 98 FX2 (soundtrack)
- 99 FX3 (crystal)
- 100 FX4 (atmosphere)
- 101 FX5 (brightness)
- 102 FX6 (goblins)
- 103 FX7 (echoes)
- 104 FX8 (sci-fi)

ETHNIC

- 105 Sitar
- 106 Banjo
- 107 Shamisen
- 108 Koto
- 109 Kalimba
- 110 Bagpipe
- 111 Fiddle
- 112 Shanai

PERCUSSIVE

- 113 Tinkle Bell
- 114 Agogo
- 115 Steel Drums
- 116 Wood Block
- 117 Taiko Drum
- 118 Melodic Tom
- 119 Synth Drum
- 120 Reverse Cymbal

SOUND EFFECTS

- 121 Guitar Fret Noise
- 122 Breath Noise
- 123 Seashore
- 124 Bird Tweet
- 125 Telephone Ring
- 126 Helicopter
- 127 Applause
- 128 Gunshot

Song List

No.	Name	Type
1	Drum Intro	Loop
2	Drum Main A	Loop
3	Drum Main B	Loop
4	Electronic&Funk	Loop
5	Modern Pop	Loop
6	Fusion 1	Loop
7	HipHop	Loop
8	Latin Jazz 1	Loop
9	Funk 1	Loop
10	Big Band 1	Loop
11	Funk 2	Loop
12	Pop Funk 1	Loop
13	Fusion 2	Loop
14	Funk 3	Loop
15	Fusion 3	Loop
16	Funk 4	Loop
17	Fusion 4	Loop
18	Pop Funk 2	Loop
19	R&B	Loop
20	Drum & Bass 1	Loop
21	Break Beat	Loop
22	Dance	Loop
23	Drum & Bass 2	Loop
24	Latin Dance 1	Loop
25	Latin Dance 2	Loop
26	Swing 1	Loop
27	Latin Jazz 2	Loop
28	Big Band 2	Loop
29	3/4 Jazz	Loop
30	Jazz 1	Loop
31	Latin Jazz 3	Loop
32	Swing 2	Loop
33	6/8 Ballad	Loop
34	Pop Ballad	Loop
35	Pop Bossa	Loop
36	16Beat Pop	Loop
37	Pop Shuffle	Loop
38	Ballad	Loop
39	Samba 1	Loop
40	Latin Pop 1	Loop

No.	Name	Type
41	Mambo	Loop
42	Latin Rock 1	Loop
43	Latin Pop 2	Loop
44	Guitar Bossa	Loop
45	Country Blues	Loop
46	Rock	Loop
47	Reggae 1	Loop
48	60's Rock	Loop
49	Blues	Loop
50	World 1	Loop
51	World 2	Loop
52	Latin	Loop
53	Bossa	Loop
54	Samba 2	Loop
55	3/4 Pop	Loop
56	Pop	Loop
57	Jazz 2	Loop
58	Reggae 2	Loop
59	Reggae 3	Loop
60	Latin Rock 2	Loop
61	Chorused Piano Tap 1	Hit
62	Fifths Tap	Hit
63	Brightness Tap 1	Hit
64	Atmosphere	Hit
65	Chorused Piano Tap 2	Hit
66	Bass Tap 1	Tap
67	Synth string Tap	Tap
68	Brightness Tap 2	Tap
69	Bass Tap 2	Tap
70	Pad Tap 1	Tap
71	Vibraphone	Tap
72	Bass Tap 3	Tap
73	Rain Tap	Tap
74	Pizzcato Strings	Tap
75	Bass Tap 4	Tap
76	Crystal	Tap
77	Xylophone	Tap
78	Bass Tap 5	Tap
79	Pad Tap 2	Tap
80	Glockenspiel Tap	Tap

Pattern List

Number	Name	Beat	Tempo	Measure
1	Beat 1	4/4	100	4
2	Beat 2	4/4	100	4
3	Beat 3	4/4	100	4
4	Beat 4	4/4	100	4
5	Beat 5	4/4	100	4
6	Beat 6	4/4	100	4
7	Beat 7	4/4	100	4
8	Beat 8	4/4	100	4
9	Beat 9	4/4	100	4
10	Beat 10	4/4	100	4
11	Beat 11	4/4	100	4
12	Beat 12	4/4	100	4
13	Beat 13	4/4	100	4
14	Beat 14	4/4	100	4
15	Beat 15	4/4	100	4
16	Beat 16	4/4	100	4
17	Beat 17	4/4	100	4
18	Beat 18	4/4	100	4
19	Beat 19	4/4	100	4
20	Beat 20	4/4	100	4
1	Funk 1	4/4	110	4
2	Funk 2	4/4	90	4
3	HipHop 1	4/4	90	4
4	HipHop 2	4/4	113	4
5	Jazz 1	4/4	157	4
6	Jazz 2	4/4	187	4
7	Latin 1	4/4	190	4
8	Latin 2	4/4	200	4
9	Pop Rock 1	4/4	105	4
10	Pop Rock 2	4/4	97	4
11	Rock	4/4	100	4
12	6/8 Pop Rock	6/8	125	4
1	Funk	4/4	120	4
2	HipHop	4/4	110	4
3	Latin Jazz	4/4	130	8
4	6/8 Ballad	6/8	96	4
5	Bossanova	4/4	82	8
6	R&B	4/4	86	4
7	3/4 Jazz	3/4	120	10
8	Reggae	4/4	78	4
9	Rock	4/4	100	4
10	Fusion	4/4	103	4

Parameter List

NORMAL MODE

KIT

Parameter	Abbreviation	Value
Kit Number	NUM	1—45
Kit Volume	VOL	0—32
Reverb	REV	ON / OFF
EQ High	EQH	-12 -- +12
EQ Middle	EQM	-12 -- +12
EQ Low	EQL	-12 -- +12

SONG

Parameter	Abbreviation	Value
Song Number	NUM	1—80
Accomp Volume of Song	ACC	0—32
Drum Volume of Song	DRM	0—32

UTILITY

Parameter	Abbreviation	Value
Pad Sensitivity	SEN	1—16
Pad Threshold	THR	0—16
Crosstalk	CRO	1—16
Curve	CUR	1—6
Rim Sensitivity	R-S	1—16
Splash Sensitivity	S-S	1—9
Local on/off	LOC	ON/OFF
GM on/off	GM	ON/OFF

TEMPO

Parameter	Abbreviation	Value
TEMPO	BPM	30—280

VOICE

Parameter	Abbreviation	Value
Voice Number	NUM/H-C	1—400/1—7
Voice Volume	VOL	0—32
Voice Pan	PAN	-8 -- +8
Voice Pitch	PIT	-8 -- +8
Voice Reverb	REV	0—16
MIDI Note	MID	0—127
Pad Song Switch	P-S	ON / OFF
Pad Song Number	P-N	1—80

CLICK

Parameter	Abbreviation	Value
Signature	SIG	0-9/2, 0-9/4, 0-9/8, 0-9/16
Interval	INT	1-2, 3-8, 1-4, 1-8, 1-12, 1-16
Click Volume	VOL	0—32
Click Voice	VOC	1—5

RECORD

Parameter	Abbreviation	Value
Song Number	SNG	---/1—60
Kit	KIT	1—45
Tempo	BPM	30—280
Signature	SIG	1-9/2, 1-9/4, 1-9/8, 1-9/16
Interval	INT	1-2, 3-8, 1-4, 1-8, 1-12, 1-16
Drum Off	DRM	---/ON/OFF
Pre Count	PRC	ON/OFF

LEARNING MODE

BEAT

Parameter	Abbreviation	Value
Beat Type	BEA	1--20
Drum Volume	DRM	0--32

RHYTHM

Parameter	Abbreviation	Value
Rhythm Type	RHM	1--12
Level	LEV	1--6
Drum Volume	VOL	0--32

PATTERN

Parameter	Abbreviation	Value
Pattern Type	PTN	1--10
Level	LEV	1--5
Accompany Volume	ACC	0--32
Drum Volume	DRM	0--32

MIDI Implementation Chart

Function		Transmitted	Recognized	Remarks
Basic	Default	10ch	1—16	
Channel	Changed	x	x	
Mode	Default	x	x	
	Messages	x	x	
	Altered	*****	*****	
Note		0—127	0—127	
Number	: True Voice	*****	0—127	
Velocity	Note On	○ 99H,V=1-127	○	
	Note Off	x (99H,V=0)	○	
after	Key's	x	○ (drum kit part only)	
Touch	Ch's	x	x	
Pitch Bend		x	x	
Control	0	x	○	Bank Select
Change	1	x	○	Modulation
	5	x	○	Portamento Time
	6	x	○	Data Entry
	7	x	○	Volume
	10	x	○	Pan
	11	x	○	Expression
	64	x	○	Sustain Pedal
	65	x	○	Portamento On/Off
	66	x	○	Sostenuto Pedal
	67	x	○	Soft Pedal
	80	x	○	Reverb Program
	81	x	○	Chorus Program
	91	x	○	Reverb Level
	93	x	○	Chorus Level
	120	x	○	All Sound Off
	121	x	○	Reset All Controllers
	123	x	○	All Notes Off
Program		x	○	
Change	: True Number	xxxxxxx	0-127	
System Exclusive		x	○	
System	: Song Position	x	x	
Common	: Song Select	x	x	
	: Tune	x	x	
System	: Clock	○	x	
Real Time	: Commands	○	x	Start And Stop Only
Aux	: Local On/off	x	x	
	: All Notes Off	x	x	
Messages	: Active Sensing	x	○	
	: Reset	x	x	