

# Classic Cantabile KH-238 Kopfhörer HiFi dynamisch

ArtNr.: 00016331



## Bedienungsanleitung

Version: 10.2024

Vielen Dank, dass Sie sich für dieses Produkt entschieden haben. Um sicherzustellen, dass Sie mit dem Classic Cantabile Kopfhörer voll und ganz zufrieden sind, lesen Sie sorgfältig und verstehen Sie diese Bedienungsanleitung, bevor Sie unser Produkt verwenden. Bewahren Sie diese Bedienungsanleitung an einem sicheren Ort auf. Die Bedienungsanleitung muss an alle nachfolgenden Anwender weitergegeben werden.



Bedienungsanleitung beachten!



**WARNUNG**

Mit dem Signalwort **WARNUNG** sind die Gefahren gekennzeichnet, die ohne Vorsichtsmaßnahmen zu schweren Verletzungen führen können.



**HINWEIS**

Mit dem Signalwort **HINWEIS** sind allgemeine Vorsichtsmaßnahmen gekennzeichnet, die im Umgang mit dem Produkt beachtet werden sollen.



**HINWEIS**

Bilder und Bildschirmdarstellungen in dieser Bedienungsanleitung können vom Erscheinungsbild des tatsächlichen Produkts geringfügig abweichen, solange dies keine negativen Auswirkungen auf die technischen Eigenschaften und Sicherheit des Produkts hat.



**HINWEIS**

Alle personenbezogenen Formulierungen in dieser Bedienungsanleitung sind geschlechtsneutral zu betrachten.

Diese Bedienungsanleitung gilt für Personen, die von einer für ihre Sicherheit verantwortlichen Person beaufsichtigt oder in die Bedienung des Gerätes eingewiesen wurden und nachgewiesen haben mit dem Gerät umgehen zu können.



**WARNUNG**

**Kinder sollten beaufsichtigt werden, um sicherzustellen, dass sie nicht mit dem Kopfhörer spielen.  
Der Kopfhörer ist kein Spielzeug**

Alle Informationen in dieser Bedienungsanleitung wurden nach bestem Wissen und Gewissen kontrolliert. Weder Autor noch Herausgeber können jedoch für Schäden haftbar gemacht werden, die in Zusammenhang mit der Verwendung dieser Bedienungsanleitung stehen.

Sonstige, in diesem Dokument aufgeführte Produkt-, Marken- und Unternehmensbezeichnungen können die Warenzeichen ihrer jeweiligen Eigentümer sein. Die Einhaltung sämtlicher anwendbarer Urheberrechtsgesetze liegt in der Verantwortung des Anwenders dieses Dokuments.

## Detaillierte Sicherheitshinweise:

**⚠ HINWEIS**

- Lesen Sie diese Anweisungen und bewahren Sie diese Anleitung auf.
- Beachten Sie alle Warnungen. Befolgen Sie alle Anweisungen.
- Verwenden Sie dieses Gerät nicht im Wasser.
- Reinigen Sie das Gerät nur mit einem trockenen Tuch.
- Legen Sie das Gerät nicht in auf Wärmequellen wie Heizkörpern, Öfen oder andere Geräte, die Wärme erzeugen.
- Achten Sie auf die Lautstärke! Hören mit zu hohem Lautstärkepegel kann Ihr Gehör dauerhaft schädigen.
- Wenden Sie sich bezüglich aller Reparatur- /Wartungsarbeiten an qualifiziertes Servicepersonal. Öffnen Sie das Gerät bzw. das Gehäuse nicht eigenmächtig. Eine Wartung ist erforderlich, wenn das Gerät auf irgendeine Weise beschädigt wurde, z. B. wenn das Kabel beschädigt ist, Flüssigkeit verschüttet wurde oder das Gerät Regen oder Feuchtigkeit ausgesetzt war, nicht ordnungsgemäß funktioniert.



## Beschreibung:

### Funktion:

Der Kopfhörer kann mit jedem Abspielgerät (z.B. CD-Player) als auch Instrument (z.B. E-Drumset, Keyboard oder Piano) verbunden werden. Hierbei ist je nach Buchse lediglich auf den Einsatz der korrekten 3,5 mm Klinke oder der 6,3 mm Klinke des Adapters zu achten.(Adapter liegt bei)

**⚠ WARNUNG**

Achten Sie auf die Lautstärke! Hören mit zu hohem Lautstärkepegel kann Ihr Gehör dauerhaft schädigen.

## Wartung

Ihr Gerät erfordert keine besondere Wartung. Wenden Sie sich jedoch im Falle einer Fehlfunktion an ein zugelassenes Servicecenter oder den Hersteller

## Reinigung

Verwenden Sie zur Reinigung ein fusselfreies und nur leicht feuchtes Tuch.

## Technische Spezifikationen:

**System:** dynamische Kopfhörer

**Nennimpedanz:** 32 Ohm

**Lautsprecher:** Stereo

**Frequenzbereich:** 20-20000 Hz

**Empfindlichkeit:** 110dB SPL

### WEEE-Erklärung

(Waste of Electrical and Electronic Equipment)

Ihr Produkt wurde unter Verwendung hochwertiger Materialien und Komponenten entwickelt und hergestellt, die recycelbar und wiederverwendbar sind. Das Symbol bedeutet, dass Ihr Produkt am Ende seiner Lebensdauer vom Hausmüll getrennt entsorgt werden muss.

Entsorgen Sie dieses Gerät bei Ihrer örtlichen Sammelstelle oder Recyclingstelle. Bitte helfen Sie mit, die Umwelt zu schützen, in der wir alle leben.

Alle technischen Daten und Erscheinungsbilder können ohne vorherige Ankündigung geändert werden. Alle Angaben waren zum Zeitpunkt der Drucklegung korrekt. Die Musikhaus Kirstein GmbH übernimmt keine Gewähr für die Richtigkeit oder Vollständigkeit der in diesem Handbuch enthaltenen Beschreibungen, Fotos oder Aussagen. Gedruckte Farben und Spezifikationen können geringfügig vom Produkt abweichen. Produkte der Musikhaus Kirstein GmbH werden nur über autorisierte Händler vertrieben. Distributoren und Händler sind keine Vertreter der Musikhaus Kirstein GmbH und nicht befugt, die Musikhaus Kirstein GmbH in irgendeiner Weise rechtlich zu binden.

Diese Bedienungsanleitung ist urheberrechtlich geschützt. Die Vervielfältigung dieser Bedienungsanleitung, auch auszugsweise, ist nur mit Genehmigung der Musikhaus Kirstein GmbH gestattet. Gleiches gilt für die Vervielfältigung oder das Kopieren von Bildern, auch in geänderter Form.

© 2024

 **KIRSTEIN.de**

**Musikhaus Kirstein GmbH**

**Bernbeurener Str. 11**

**D-86956 Schongau**

**info@kirstein.de**

**www.kirstein.de**

**Telefon/Phone: +49(0)8861 / 90 94 94 -0**



# Classic Cantabile KH-238 Headphones HiFi dynamic

Item number: 00016331



## User Manual

Version: 10.2024

Thank you for choosing this product.

To ensure that you are fully satisfied with the Classic Cantabile headphones, read this manual carefully and understand these instructions before using our product. Keep these operating instructions in a safe place. The operating instructions must be passed on to all subsequent users.



Please carefully follow the instructions!



**WARNING**

The signal word **WARNING** indicates the dangers that can lead to serious injuries without precautionary measures.



**NOTE**

The signal word **NOTE** indicates general precautionary measures that should be observed when handling the product.



**NOTE**

Images and screen shots in this manual may differ slightly from the appearance of the actual product as long as this has no negative effects on the technical properties and safety of the product.



**NOTE**

All personal formulations in these operating instructions are to be considered gender-neutral.

These operating instructions apply to persons who have been supervised by a person responsible for their safety or who have been instructed in the operation of the device and have demonstrated that they can handle the device.



**WARNING**

**Children should be supervised to ensure that they do not play with the device.**

**Do not leave children unattended. The product is not a toy!**

All information in this operating manual has been checked to the best of our knowledge and belief. However, neither the author nor the publisher can be held liable for any damage associated with the use of this manual.

Other product, brand and company names mentioned in this document may be the trademarks of their respective owners. Compliance with all applicable copyright laws is the responsibility of the user of this document.

---

**Detailed safety information:****⚠ NOTE**

- Read these instructions. Keep these instructions.
- Heed all warnings. Follow all instructions.
- Do not use this device near water.
- Only clean the device with a dry cloth.
- Do not block any ventilation openings.
- Do not place the device near heat sources such as radiators, stoves or other devices that generate heat.
- Pay attention to the volume! Hearing at a high-volume level can permanently damage your hearing.
- Contact qualified service personnel for all repair / maintenance work. Do not open the device or the housing yourself. Maintenance is required if the device has been damaged in any way, e.g., if the power cord or plug is damaged, liquid has been spilled or objects have fallen into the device, the device has been exposed to rain or moisture, is not working properly or has been dropped.

**Function:**

The headphones can be connected to every playing device (e.g., CD-players) as well as instrument (e.g., E-drumset, keyboard or piano). It is only important to note which jack plug is required for the used device: the 3.5 mm jack or the 6.3 mm jack of the adapter. (Adapter is included in delivery)

**⚠ WARNING** Pay attention to the volume! Hearing at a high-volume level can permanently damage your hearing.

## Maintenance

Your device does not require any special maintenance. However, in the event of a malfunction, contact an approved service center or the manufacturer

## Cleaning

Use a lint-free and only slightly damp cloth for cleaning.

## Technical specifications:

**System:** dynamic headphones

**Impedance:** 32 Ohm

**Speakers:** Stereo

**Frequency range:** 20-20000 Hz

**Sensitivity:** 110dB SPL

### WEEE declaration (Waste of Electrical and Electronic Equipment)

Your product has been developed and manufactured using high quality materials and components that are recyclable and reusable. The symbol means that your product must be disposed of separately from household waste at the end of its service life.

Dispose of this device at your local collection or recycling centre, please help protect the environment we all live in.

All technical data and appearances are subject to change without notice. All information was correct at the time of printing. Musikhaus Kirstein GmbH assumes no liability for the correctness or completeness of the descriptions, photos or statements contained in this manual. Printed colours and specifications may differ slightly from the product. Musikhaus Kirstein GmbH products are only sold through authorized dealers. Distributors and dealers are not representatives of Musikhaus Kirstein GmbH and are not authorized to bind Musikhaus Kirstein GmbH legally in any way.

This manual is protected by copyright. Reproduction of these operating instructions, in whole or in part, is only permitted with the approval of Musikhaus Kirstein GmbH. The same applies to the duplication or copying of images, even in modified form.

© 2024

 **KIRSTEIN.de**

**Musikhaus Kirstein GmbH**

**Bernbeurener Str. 11**

**D-86956 Schongau**

**info@kirstein.de**

**www.kirstein.de**

**Phone: +49(0)8861 / 90 94 94 -0**





# FUNKEY

## DP-88 II Digitalpiano

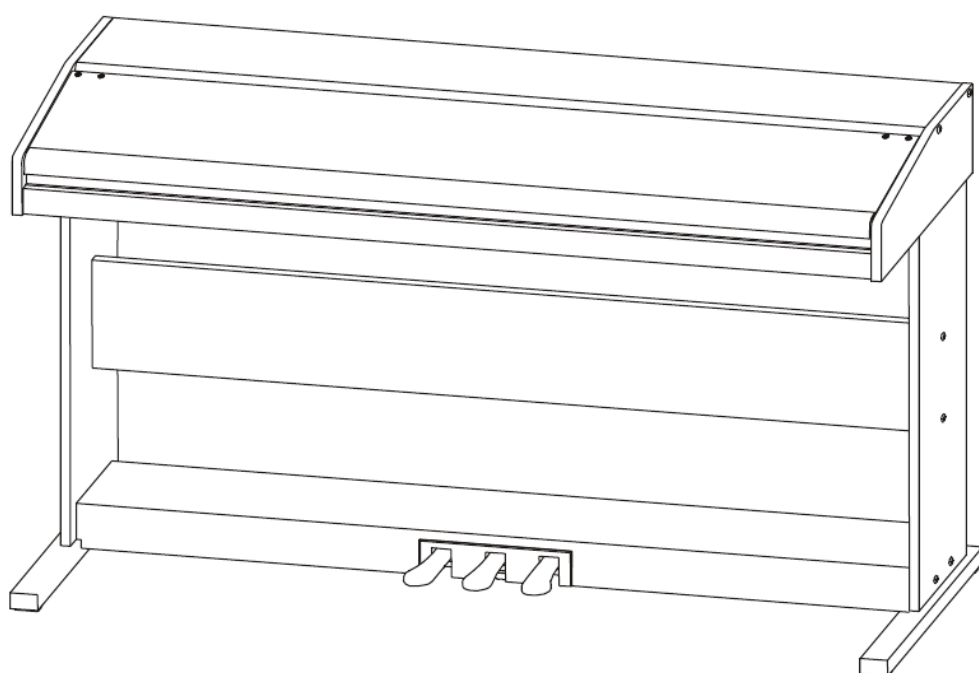

## Bedienungsanleitung / User Manual

Version 05/2020

## Einleitung

Herzlichen Dank, dass Sie sich für das **Funkey DP-88 II Digitalpiano** entschieden haben.

**Wir wünschen Ihnen viel Spaß und Freude mit Ihrem neuen Funkey DP-88 II Digitalpiano.**

Bitte lesen Sie diese Anleitung aufmerksam, um die praktischen Funktionen des **Funkey DP-88 II Digitalpianos** voll nutzen zu können.

Außerdem empfehlen wir Ihnen, dieses Handbuch an einem sicheren und leicht zugänglichen Ort aufzubewahren, um später darin nachschlagen zu können.

### **Achtung!**

Vor dem ersten Einschalten und der Inbetriebnahme des Geräts lesen Sie auf Jeden Fall die Sicherheitsanweisungen durch um Verletzungen sowie Beschädigungen des Geräts zu vermeiden.

## Bedienungsanleitung (deutsch) ab Seite 3

---

### Introduction

Thank you for your purchase of the **Funkey DP-88 II Digitalpiano**.

**We hope that you will enjoy the use of the Funkey DP-88 II Digitalpiano.**

Please read through this manual carefully before beginning to use, so that you will be able to take full advantage of the **Funkey DP-88 II Digitalpiano** features and enjoy trouble-free operation for years to come.

Please keep this manual at a safe and dry place where you easily can access it.

### **Caution !**

Before switching on the instrument or device read carefully the safety instructions to avoid serious injuries or damage of the product.

## Operators manual (english) -> start from page 31

## **Informationen zu Ihrer Sicherheit**

**Bitte lesen Sie den folgenden Abschnitt sorgfältig durch, bevor Sie das Instrument in Gebrauch nehmen! Bitte bewahren Sie diese Bedienungsanleitung sorgfältig auf.**

### **Stromversorgung**

Bitte schließen Sie das mitgelieferte Netzkabel (ggf. Netzteil) an einer Steckdose mit korrekter Spannung an. Verbinden Sie das Gerät nicht mit einer Steckdose, deren Spannung für das Gerät nicht geeignet ist. Trennen Sie das Netzteil vom Strom, wenn Sie das Instrument nicht benutzen oder während eines Gewitters.

### **Anschlüsse**

Bevor Sie das Instrument mit anderen Geräten verbinden, schalten Sie bitte alle Geräte zuerst aus. Das bewahrt die Geräte vor Schäden und hilft, Fehlfunktionen zu vermeiden.

### **Umgebung**

Setzen Sie das Gerät den folgenden Bedingungen bitte nicht aus, um Verformungen, Verfärbungen oder ernsthaftere Schäden zu vermeiden:  
direktem Sonnenlicht, extremen Temperaturen, extremer Feuchtigkeit, Staub oder Schmutz, starken Vibrationen oder Erschütterungen, magnetischen Feldern

### **Interferenzen**

Sind Radio- oder Fernsehgeräte in der Nähe des Instruments aufgestellt, kann es zu Interferenzen kommen. Sollte das der Fall sein, stellen Sie die Geräte bitte weiter auseinander.

### **Reinigung**

Bitte reinigen Sie das Instrument ausschließlich mit einem weichen, trockenen Tuch. Benutzen Sie bitte keine Farbverdünner, Lösungsmittel, Reinigungsflüssigkeiten oder chemisch imprägnierte Reinigungstücher.

### **Handhabung**

Wenden Sie bitte keine übermäßige Gewalt beim Umgang mit Knöpfen und Schaltern an und sorgen Sie dafür, dass kein Papier, Metall oder sonstige Objekte in das Instrument gelangen können. Sollte es doch passieren, trennen Sie das Gerät bitte sofort vom Stromkreis und bringen Sie es zum Fachhändler zur Überprüfung. Entfernen Sie bitte stets alle Kabelverbindungen, bevor Sie das Instrument bewegen.

### **Öffnen des Geräts**

Das Gerät darf nur von autorisiertem Fachpersonal zu Reparaturzwecken geöffnet werden. Wenden sie sich bitte an eine Fachwerkstatt oder den Händler bei welchem Sie das Gerät gekauft haben.

|  |           |
|--|-----------|
| <b>Inhaltsverzeichnis</b>                        |           |
| <b>Anzeige- und Bedienelemente</b> .....         | <b>6</b>  |
| <b>Aufbau</b> .....                              | <b>8</b>  |
| <b>Vorbereitung vor dem Spielen</b> .....        | <b>10</b> |
| Stromversorgung .....                            | 10        |
| Kopfhöreranschluss .....                         | 10        |
| Audio Equipment anschließen.....                 | 10        |
| Computer anschließen .....                       | 10        |
| Pedale anschließen .....                         | 10        |
| USB Anschluss .....                              | 11        |
| An-/Ausschalter.....                             | 11        |
| Anpassung der Lautstärke .....                   | 11        |
| <b>Stimmauswahl</b> .....                        | <b>11</b> |
| Primärstimme auswählen.....                      | 11        |
| Sekundärstimme auswählen (Dualvoice) .....       | 11        |
| Touch-Funktion .....                             | 11        |
| Transpose.....                                   | 12        |
| Piano Modus.....                                 | 12        |
| Metronom.....                                    | 12        |
| <b>Begleitautomatik</b> .....                    | <b>12</b> |
| Begleitautomatik einrichten .....                | 12        |
| Lautstärke .....                                 | 12        |
| Tempo .....                                      | 13        |
| Auto-Chord Funktion.....                         | 13        |
| Full-Range-Chord Funktion.....                   | 13        |
| Akkordliste .....                                | 13        |
| <b>Reverb</b> .....                              | <b>14</b> |
| <b>Chorus</b> .....                              | <b>14</b> |
| <b>Soundkonsole</b> .....                        | <b>14</b> |
| <b>Funktionen</b> .....                          | <b>15</b> |
| <b>Auf Werkseinstellungen zurücksetzen</b> ..... | <b>15</b> |
| <b>Speicherfunktion</b> .....                    | <b>15</b> |
| <b>Aufnahmefunktion</b> .....                    | <b>15</b> |
| Aufnahme starten/stoppen .....                   | 16        |
| Wiedergabe .....                                 | 16        |
| Löschen von Aufnahmen .....                      | 16        |
| <b>Vorgespeicherte Songs</b> .....               | <b>16</b> |

|  |           |
|--|-----------|
| Wiedergabe .....                         | 16        |
| Lernmodus.....                           | 17        |
| MP3-Wiedergabe .....                     | 17        |
| <b>Stimmenliste .....</b>                | <b>18</b> |
| <b>Styles Liste.....</b>                 | <b>24</b> |
| <b>Songlisten .....</b>                  | <b>27</b> |
| <b>WEEE-Erklärung / Entsorgung .....</b> | <b>30</b> |
| <b>Herstellerangaben .....</b>           | <b>30</b> |

## Anzeige- und Bedienelemente

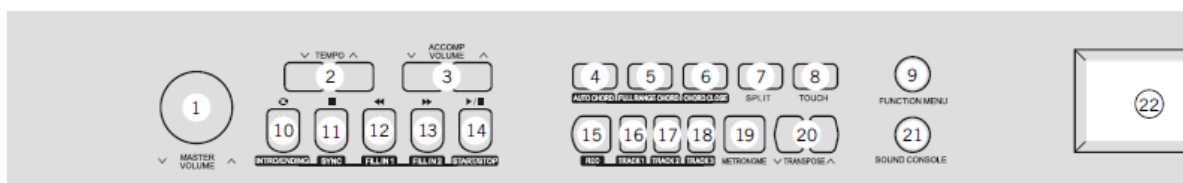

### 1 Lautstärkedrehrad

Passen Sie die Lautstärke an

### 2 Tempo Knöpfe

Passen Sie das Tempo an

### 3 Begleitlautstärke

Passen Sie die Begleitlautstärke an

### 4 Auto Chord Knopf

### 5 Full Range Chord Knopf

### 6 Chord Close Knopf

### 7 Split Knopf

### 8 Touch Knopf

### 9 Funktions Knopf

Betreten Sie das Funktionsmenü

### Im Songmodus:

### 10

Setzen Sie den Anfangs-/Endpunkt für eine Dauerschleife

### 11

Pausieren Sie die Wiedergabe

### 12

Spulen Sie vor/zurück

### 13

Starten oder Beenden Sie die Wiedergabe

### Im Stilmodus:

### 10 Intro/Ending Knopf

Spielen Sie ein automatisches Intro/Ending ab

### 11 Sync Knopf

Aktivieren/Deaktivieren Sie die Sync Funktion

### 12 FILL IN 1

Spielen Sie die Fill 1 Variation ab

### 13 FILL IN 2

Spielen Sie die Fill 2 Variation ab

### 14 Start/Stop

Starten oder Beenden Sie die Wiedergabe der Begleitautomatik

### 15 REC

Starten Sie die Aufnahmefunktion

### 16 TRACK 1

Wählen Sie Track 1 zur Aufnahme aus

### 17 TRACK 2

Wählen Sie Track 2 zur Aufnahme aus

### 18 TRACK 3

Wählen Sie Track 3 zur Aufnahme aus

### 19 Metronom

Aktivieren/Deaktivieren Sie das Metronom

### 20 Transpose

### 21 Soundkonsole

Betreten Sie das Soundkonsolen Menü

### 22 LCD Display

## LCD-Display

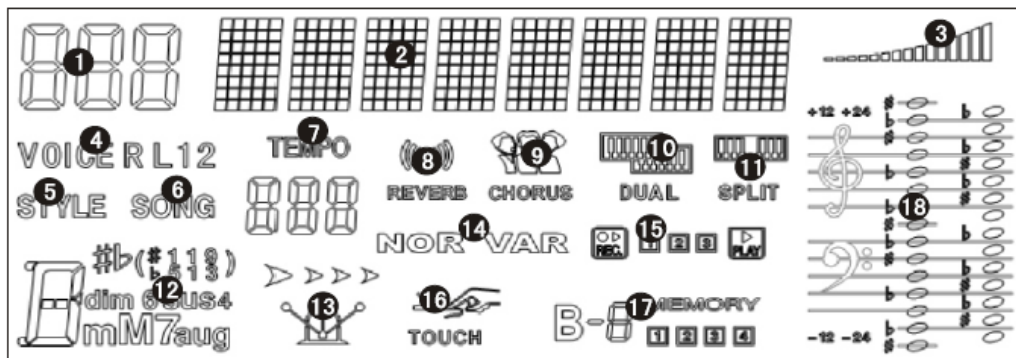

- |                           |                         |                                |
|---------------------------|-------------------------|--------------------------------|
| <b>1</b> Digitale Anzeige | <b>7</b> Tempo          | <b>13</b> Metronom             |
| <b>2</b> Digitale Anzeige | <b>8</b> Reverb         | <b>14</b> Fill in 1/ Fill in 2 |
| <b>3</b> Lautstärke       | <b>9</b> Chorus         | <b>15</b> Aufnahme/Wiedergabe  |
| <b>4</b> Stimmauswahl     | <b>10</b> Dual Voice    | <b>16</b> Touch                |
| <b>5</b> Stilauswahl      | <b>11</b> Splitfunktion | <b>17</b> Speicherfunktion     |
| <b>6</b> Songs            | <b>12</b> Akkordanzeige | <b>18</b> Tonleiteranzeige     |

## Rechtes Panel

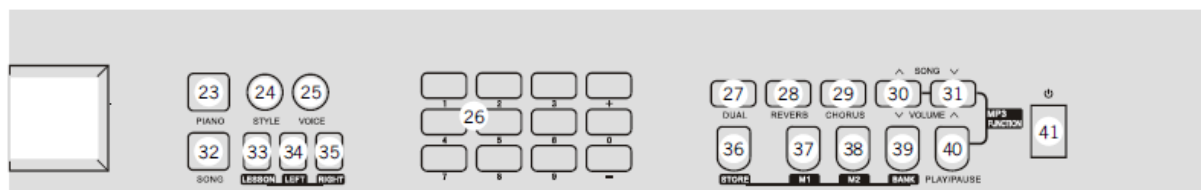

- |  |   |
|--|---|
| <b>23 Piano</b><br>Aktivieren/Deaktivieren Sie den Performance Modus   | <b>33 Lesson</b><br>Aktivieren Sie den Lernmodus                                      |
| <b>24 Style</b><br>Wechseln Sie zwischen den Stilen  | <b>34 Left</b><br>Wählen Sie die Stimme der linken Hand im Lernmodus aus              |
| <b>25 Voice</b><br>Wechseln Sie zwischen den Stimmen   | <b>35 Right</b><br>Wählen Sie die Stimme der rechten Hand im Lernmodus aus            |
| <b>26 Nummernfeld</b><br>Passen Sie hiermit Parameter an   | <b>36 Store</b><br>Speichern Sie die aktuellen Einstellungen ab (auf M1 oder M2)      |
| <b>27 Dual</b><br>Aktivieren/Deaktivieren Sie den Dual Modus   | <b>37 M1</b><br>Rufen Sie die Einstellungen auf der Speicherbank M1 ab                |
| <b>28 Reverb</b>   | <b>38 M2</b><br>Rufen Sie die Einstellungen auf der Speicherbank M2 ab                |
| <b>29 Chorus</b>   | <b>39 Bank</b><br>Wechseln Sie die Speicherbank                                       |
| <b>30 Song ^ Lautstärke v</b>  | <b>40 Play/Pause</b><br>Pausieren oder setzen Sie die Wiedergabe von MP3-Dateien fort |
| <b>31 Song v Lautstärke ^</b><br>Wechseln Sie zum vorherigen/nächsten MP3 Song. Halten Sie die Taste um die Lautstärke anzupassen. | <b>41 Power</b><br>Schalten Sie Ihr Gerät an oder aus                                 |
| <b>32 Song</b><br>Wechseln Sie in den Song-Modus   |   |

## Hinteres Panel

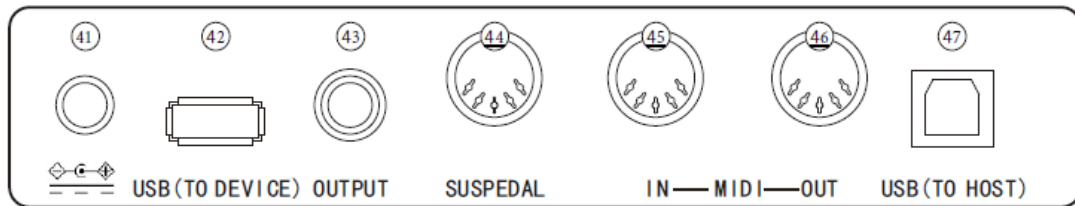

### 41 Stromanschluss

Schließen Sie hier das Netzteil an

### 42 USB Anschluss

### 43 Klinkenstecker Ausgang

### 44 Pedalanschluss

### 45 MIDI IN







### 46 MIDI OUT

### 47 USB MIDI Anschluss

Der **Kopfhöreranschluss** befindet sich als einzelne Klinkenbuchse links an der Unterseite des Instruments.

## Aufbau

### Kartoninhalt

|   |   |                                   |       |
|---|---|-----------------------------------|-------|
| ① |  | TA4*12Schrauben                   | 12stk |
| ② |  | M6*50Schrauben                    | 12stk |
| ③ |  | M6*20Schrauben                    | 4stk  |
| ④ |  | Hammermuttern 8stk                |       |
| ⑤ |  | Winkelverbinder                   |       |
| ⑥ |  | Plastikabdeckung für M6 Schrauben |       |

### Montage

1. Nutzen Sie die 12 TA4 Schrauben (1) um die 4 Winkelverbinder (5) an die linken und rechten Standfüße zu befestigen.
2. Befestigen Sie 8 Hammermuttern (4) in die passenden Löcher der linken und rechten Standfüße.
3. Nutzen Sie 4 M6x50 Schrauben (2) um die Standfüße mit den Bodenfüßen zu verbinden.
4. Befestigen Sie die hintere Wand mit den Standfüßen mit Hilfe 4 M6x50 Schrauben (2)
5. Befestigen Sie die Pedalbox an den Standfüßen mit Hilfe 4 M6x50 Schrauben und drehen Sie die Kunststoffschraube unter der Pedaleinheit bis zum Boden heraus.
6. Nun können Sie das Piano auf den Ständer auflegen und es mit Hilfe der M6x20 Schrauben (3) befestigen.



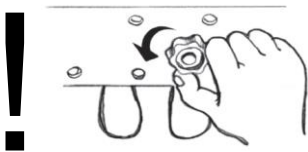
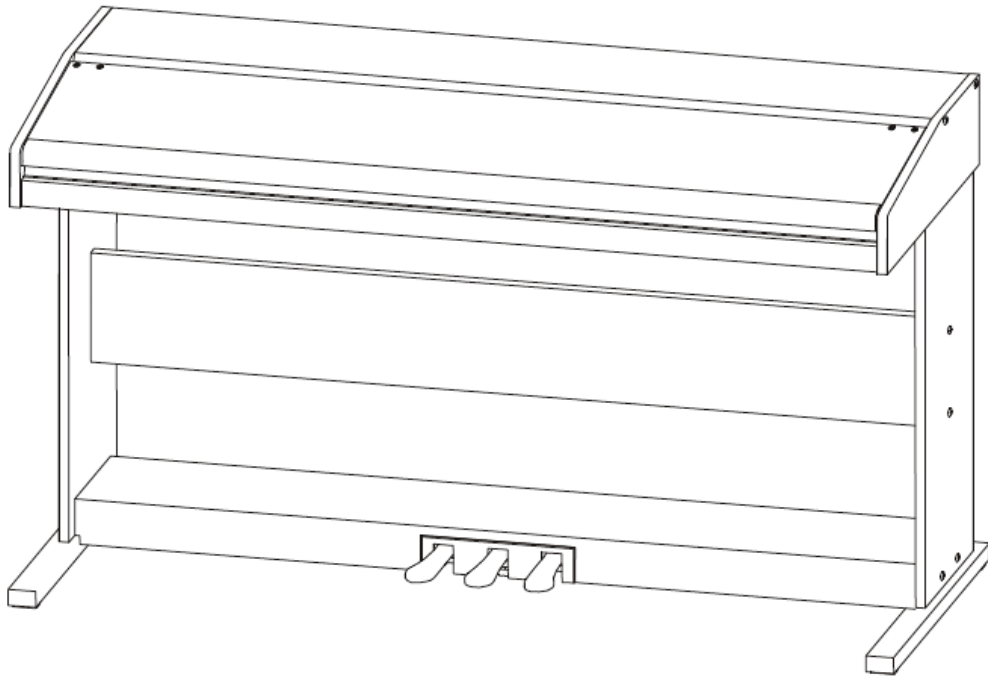
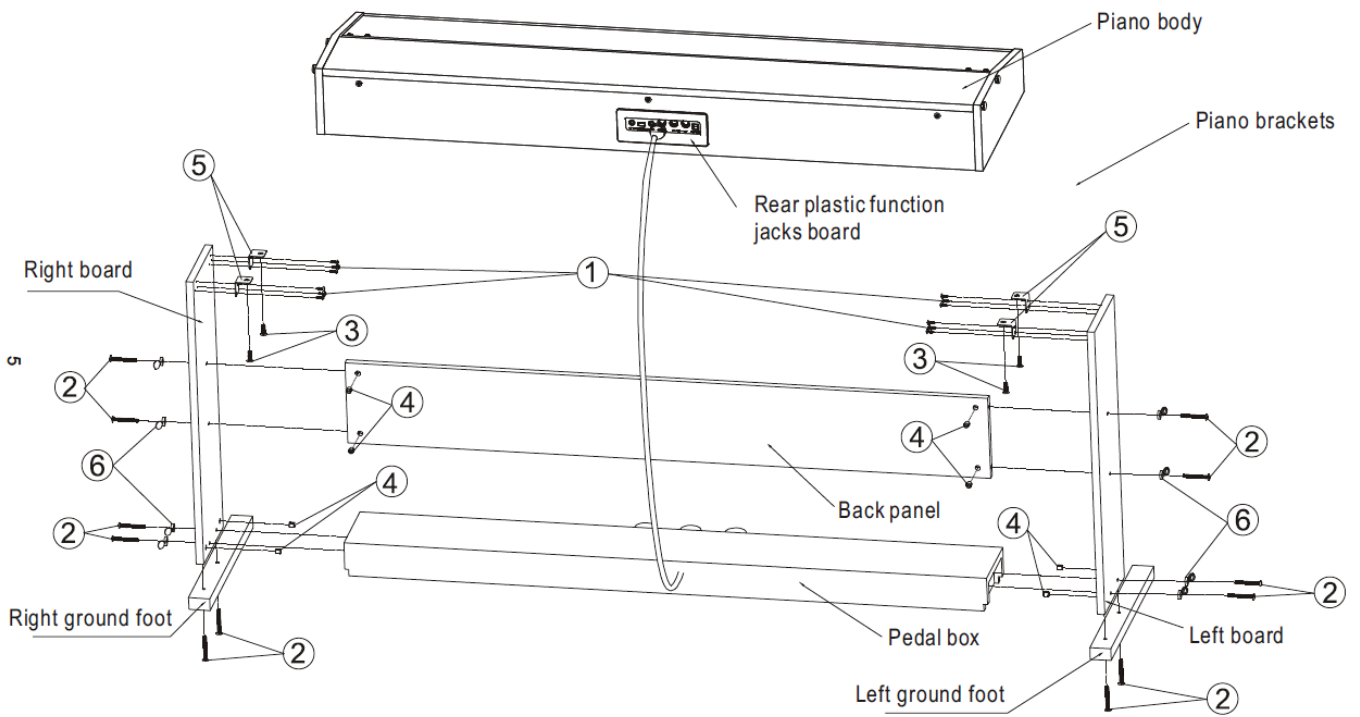



## Vorbereitung vor dem Spielen

### Stromversorgung

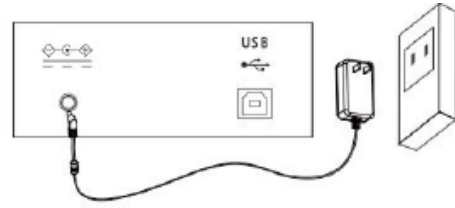
1. Stecken Sie das Netzteil in die Anschlussbuche am Piano und in Ihre Steckdose.
2. Schalten Sie das Piano mit Hilfe des POWER Knopfes an.



 Nutzen Sie nur das mitgelieferte Netzteil, da es ansonsten zu Schäden aufgrund von Spannungsunterschieden kommen kann.

### Kopfhöreranschluss

Schließen Sie einen Kopfhörer mit einem 6,35 mm-Stecker an der passenden Buchse links an der Unterseite an. Dieser Kopfhörer dient zum persönlichen Monitoring oder wenn Sie üben möchten ohne andere Personen zu beeinträchtigen, beispielsweise nachts.

### Audio Equipment anschließen

Es ist auch möglich externe Boxen an Ihr Piano anzuschließen um so ein besseres Sounderlebnis zu erhalten.

### Computer anschließen

Das Piano verfügt über einen USB Anschluss mit dem es direkt an einen PC angeschlossen werden kann und dadurch MIDI Signale austauschen kann.

1. Verbinden Sie das Piano mit dem Computer.
2. Um das Piano als MIDI Gerät nutzen zu können müssen Sie die MIDI Software auf Ihrem Computer starten und den input/output auf das USB Gerät festlegen.
3. Um das Piano als Audiogerät zu verwenden, verbinden Sie das Piano mit dem PC und stellen Sie anschließend das Audiogerät des Computers auf das Piano um.

### Pedale anschließen

#### 1. Sustain Pedal (rechtes Pedal)

Das Betätigen dieses Pedals lässt die Noten auch dann klingen, wenn Sie diese gar nicht mehr drücken.

#### 2. Sostenuto Pedal (mittleres Pedal)

Wenn Sie auf das Sostenutopedal treten, während Sie Tasten gedrückt halten, werden die Töne so lange ausgehalten, wie Sie das Pedal loslassen. Die anschließend gespielten Töne werden nicht ausgehalten sondern normal wiedergegeben. So können Sie beispielsweise einen Akkord mit Sustain versehen und andere Noten staccato spielen.

#### 3. Soft Pedal (linkes Pedal)

Dieses Pedal reduziert die Lautstärke und ändert leicht das Timbre der gespielten Noten.

## USB Anschluss

Mit Hilfe des USB Anschluss können Sie sehr einfach MP3-Dateien abspielen.

## An-/Ausschalter

Schalten Sie hiermit Ihr Gerät an oder aus.

## Anpassung der Lautstärke

Drehen Sie an diesem Rad um die Lautstärke anzupassen.

## Stimmauswahl

Dieses Piano verfügt über die Fähigkeit, wie akustische, hochwertige Pianos/Flügel zu klingen und gleichzeitig wie andere Instrumente wie z.B. Schlagzeug zu klingen.

### Primärstimme auswählen

1. Drücken Sie TONE. Das Display zeigt nun R1 an.
2. Wählen Sie mit Hilfe von + / - die gewünschte Stimme aus.

### Sekundärstimme auswählen (Dualvoice)

1. Drücken Sie DUAL um die Funktion zu aktivieren. Das Display zeigt nun R2 an.
2. Wählen Sie mit Hilfe von + / - die gewünschte Stimme aus.
3. Nun hört es sich an als würden zwei Instrumente gleichzeitig spielen.
4. Drücken Sie DUAL erneut um die Funktion zu deaktivieren.



DUAL



## Touch-Funktion

Diese Funktion bestimmt, in wie weit Ihre Anschlagskraft die Lautstärke des Sounds beeinflusst. Es stehen vier Einstellungsmöglichkeiten zur Verfügung, so dass Sie die Anschlagstärke der Art des Sounds, dem Song oder Ihren eigenen Vorlieben anpassen können.

**Off:** In dieser Einstellung klingen alle Töne gleich laut, egal wie fest oder zart Sie die Taste spielen.

**Soft:** Die Sounds klingen relativ laut, auch wenn Sie sanft spielen.

**Normal:** In dieser Einstellung klingt das Piano wie ein normales Klavier.

**Hard:** Sie müssen sehr kräftig spielen, um ein Maximum an Lautstärke zu erreichen.



TOUCH

Drücken Sie TOUCH um die Funktion zu aktivieren. Zur Auswahl des Modus drücken Sie TOUCH mehrfach.



TOUCH

## Transpose

Mit dieser Funktion können Sie die Tonhöhe des Pianos in Halbtonschritten verändern um sie an andere Instrumenten oder Sängern anzupassen. Sie können so ganz einfach die Tonart wechseln ohne Ihren Fingersatz anpassen zu müssen. Wenn z.B. Transpose F gewählt ist, ertönt ein F, wenn Sie ein C spielen. In anderen Worten: Sie können das Stück in C-Dur spielen und hören es transponiert auf F-Dur.

1. Drücken Sie Transpose v / Transpose ^ um den Modus zu aktivieren.
2. Ändern Sie den Wert mit v / ^ (-012 - +012).
3. Der Standardwert ist hierbei 000.



## Piano Modus

Drücken Sie PIANO um den Modus zu aktivieren.



## Metronom

Falls Sie sich noch nicht sicher fühlen können Sie das Metronom aktivieren um die Einhaltung des Takts zu lernen.

Drücken Sie hierfür METRONOM um es zu aktivieren/deaktivieren.



## Begleitautomatik

Ihr Instrument besitzt über verschiedene Begleiter welche Sie verwenden können um Ihr gespieltes mit einem vollen Orchester als Begleiter zu ergänzen. Während diese Funktion aktiviert ist kreiert der automatische Begleiter abhängig von Ihren gespielten Akkorden und Noten im unten abgebildeten Bereich passende Töne. Der restliche Teil des Pianos ist immer noch für normales Spielen ohne Begleiter verfügbar.

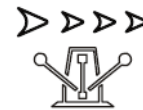

## Begleitautomatik einrichten

1. Drücken Sie STYLE um in den Stilmodus zu gelangen.
2. Wählen Sie den Begleitmodus mit Hilfe von + / - aus.
3. Starten Sie die Wiedergabe mit Hilfe von START/STOP.



Hinweis: Ihr Piano verfügt neben den verschiedenen Stilen über eine Intro- bzw. Ending-Funktion sowie über zwei verschiedene Fill In-Funktionen.



## Lautstärke

Passen Sie die Lautstärke mit Hilfe der ACCOMP VOLUME ^ / v Knöpfe an.



## Tempo

Jeder Stil verfügt über ein eigenes Tempo, welches Sie jederzeit anpassen können. Drücken Sie hierzu die TEMPO ^/v Knöpfe

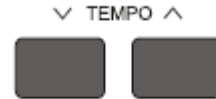

## Auto-Chord Funktion

Nach dem Drücken von AUTO CHORD spielt das Piano passende Akkorde zu den von Ihnen gespielten Noten (Nur die linke Hand ist betroffen).



## Full-Range-Chord Funktion

Nach dem Drücken von AUTO CHORD spielt das Piano passende Akkorde zu den von Ihnen gespielten Noten (Beide Hände sind betroffen).

## Akkordliste

| Original name                | Abbr.             | Normal pronunciation    |
|------------------------------|-------------------|-------------------------|
| MAJOR                        | M                 | 1-3-5                   |
| MAJOR SIXTH                  | M6                | 1-3-5-6                 |
| MAJOR SEVENTH                | M7                | 1-3-(5)-7               |
| MAJOR SEVENTH SHARP ELEVENTH | M7#11             | 1-(2)3# 4-(5)-7         |
| MAJOR ADD NINTH              | Madd9             | 1-2-3-5                 |
| MAJOR NINTH                  | M9                | 1-2-3-(5)-7             |
| MAJOR SIXTH ADD NINTH        | 69                | 1-2-3-(5)-6             |
| AUGMENTED                    | aug               | 1-3-#5                  |
| MINOR                        | m                 | 1 <sup>b</sup> 3-5      |
| MINOR SIXTH                  | m6                | 1 <sup>b</sup> 3-5-6    |
| MINOR SEVENTH                | m7                | 1- <sup>b</sup> 3-(5)-7 |
| MINOR SEVENTH FLATTED FIFTH  | m7 <sup>b</sup> 5 | 1-3-5-7                 |
| MINOR ADD NINTH              | madd9             | 1-2-3-5                 |
| MINOR ADD NINTH              | m9                | 1-2-3-5                 |
| MINOR MAJOR ELEVENTH         | m11               | 1-3-(5)-7               |
| MINOR MAJOR SEVENTH          | mM7               | 1- <sup>b</sup> 3-(5)-7 |
| MINOR MAJOR NINTH            | mM9               | 1-2-3-(5)-7             |
| DIMINISHED                   | dim               | 1-3-5                   |
| DIMINISHED SEVENTH           | dim7              | 1-3-5-6                 |
| SEVENTH                      | 7                 | 1-3(5)-7                |
| SEVENTH SUSLEND FOURTH       | 7sus4             | 1-4-5-7                 |
| SEVENTH NINTH                | 79                | 1-2-3-(5)-7             |
| SEVENTH SHARP ELEVENTH       | 7#11              | 1-(2)3-#4-(5)-b7        |
| SEVENTH THIRTEENTH           | 713               | 1-3-(5)-7 / 2-3-5-6-7   |

| Original name              | Abbr.             | Normal pronunciation        |
|----------------------------|-------------------|-----------------------------|
| SEVENTH FLATTED NINTH      | 7 <sup>b</sup> 9  | 1-2-3-(5)-7                 |
| SEVENTH FLATTED THIRTEENTH | 7 <sup>b</sup> 13 | 1-3-5-6-7                   |
| SEVENTH SHARP NINTH        | 7 <sup>#</sup> 9  | (1)- <sup>#</sup> 2-3-(5)-7 |
| MAJOR SEVENTH AUGMENTED    | M7 <sup>aug</sup> | 1-3 <sup>#</sup> -5-7       |
| SEVENTH AUGMENTED          | 7 <sup>aug</sup>  | (1)-3- <sup>#</sup> 5-7     |
| SUSPENED FOURTH            | sus4              | 1-4-5                       |
| ONE PLUS TWO PLUS FIVE     | 1+2+5             | 1-2-5                       |

## Reverb

Die Reverb Funktion kann durch drücken der REVERB Taste aktiviert/deaktiviert werden.



## Chorus

Die Chorus Funktion kann durch drücken der CHORUS Taste aktiviert/deaktiviert werden.



## Soundkonsole

Hier können die einzelnen Instrumentenlautstärken in vorgefertigten Songs angepasst werden (z.B. die Lautstärke der linken Hand oder die Basslautstärke).

1. Drücken Sie SOUND CONSOLE und passen Sie die Parameter mit Hilfe von +/- an.



| Adjustment content            | LCD display | Adjustment range |
|-------------------------------|-------------|------------------|
| Percussion music track volume | XXX Rhythm  | 0 - 127          |
| Bass track volume             | XXX Bass    | 0 - 127          |
| Hamony track volume           | XXX Chord   | 0 - 127          |
| Phrase track volume           | XXX Phrase  | 0 - 127          |
| left hand track volume        | XXX Lower   | 0 - 127          |
| Right hand track volume       | XXX Upper   | 0 - 127          |

## Funktionen

Im Funktionsmenü können Sie einzelne Parameter der Funktionen anpassen und so personalisieren. Dies geschieht mit den + / - Tasten des Pianos.

1. Drücken Sie FUNCTION MENU um in das Menü zu gelangen.
2. Wählen Sie mit Hilfe von FUNCTION MENU + oder FUNCTION MENU – die gewünschte Zeile aus.
3. Nun kann der Wert mit Hilfe von + / - geändert werden.



| Serial no. | Adjustment content | LCD Display  | Adjustment range | Presetting value |
|------------|--------------------|--------------|------------------|------------------|
| 1          | Tune               | XXX Tune     | -50 ~ +50        | 000              |
| 2          | Keyboard split     | XXX KeySplit | 1 ~ 88           | 034              |
| 3          | Beat type          | XXX BeatType | 0, 2 ~ 9         | 004              |
| 4          | Metronome volume   | XXX MetroVol | 0~127            | 080              |
| 5          | Reverb depth       | XXX Revb Lev | 0~127            | 050              |
| 6          | Chorus depth       | XXX Chor Lev | 0~127            | 000              |
| 7          | MIDI Receiving     | XXX Midi In  | 1 ~ 16, ALL      | ALL              |
| 8          | MIDI Sending       | XXX Midi Out | 1 ~ 16           | 001              |

## Auf Werkseinstellungen zurücksetzen

Drücken Sie + / - während das Gerät ausgeschaltet ist um es auf den Werkszustand zurückzusetzen. Schalten Sie anschließend das Gerät an. Anschließend wird das Gerät sämtliche Daten löschen.

## Speicherfunktion

Das Gerät verfügt über eine Speicherfunktion, welche es Ihnen ermöglicht bestimmte Einstellungen abzuspeichern und somit schnell abzurufen. Hierfür stehen Ihnen zwei Speicherplätze und vier Speicherbänke zur Verfügung. Sie haben also insgesamt 8 Speichermöglichkeiten.

1. Drücken Sie STORE und anschließend M1 oder M2 um den Speicherplatz auszuwählen.
2. Um die Speicherbank zu wechseln drücken Sie BANK.
3. Drücken und halten Sie STORE und M1 um alle Speicherplätze und Speicherbänke zu leeren.



## Aufnahmefunktion

Mit Hilfe dieser Funktion können Sie eigene Songs aufnehmen und jederzeit abspielen. Das Piano verfügt über drei Tracks.

Hierbei ist TRACK1 für die Aufnahme der Begleitfunktion vorgesehen. TRACK2 und TRACK3 können zur Aufnahme zweier getrennter Melodiespuren (z.B. linke und rechte Hand) genutzt werden.

## Aufnahme starten/stoppen

1. Drücken Sie 2x RECORD. Unter der Tempoangabe im Display blinken nun vier Pfeile und signalisieren die Aufnahmebereitschaft. Das Display zeigt RecSong1. Drücken Sie +/- falls Sie einen anderen User-Speicherplatz auswählen möchten.
2. Wählen Sie die gewünschte Stimme, den gewünschten Style und das passende Tempo aus und drücken Sie TRACK 1, TRACK 2 oder TRACK 3. Durch mehrmaliges Drücken der jeweiligen TRACK-Taste ändern Sie den Status der jeweiligen Aufnahmespur. Blinkende Anzeige -> Aufnahmebereit, leuchtende Anzeige bei bereits aufgenommenen Musikdaten -> Dieser Track wird parallel zur Aufnahme wiedergegeben, keine Anzeige -> Dieser Track ist deaktiviert.
3. Um die Aufnahme zu starten drücken Sie START/STOP. Dasselbe gilt für das Stoppen der Aufnahme.



## Wiedergabe

Drücken Sie nach erfolgreicher Aufnahme RECORD um den aufgenommenen Song abzuspielen. Stoppen Sie die Wiedergabe mit Start/Stop. Hierbei können durch Drücken der TRACK-Tasten, die einzelnen Spuren der Aufnahme aktiviert, bzw. deaktiviert werden. Nach Verlassen der Aufnahmefunktion finden Sie Ihre Aufnahme im Song-Modus hinter den vorinstallierten Songs als sogenannte User-Songs.

## Löschen von Aufnahmen

1. Um alle Songs zu löschen drücken und halten Sie RECORD während das Gerät ausgeschaltet ist, betätigen den Netzschalter und drücken sofort anschließend zusätzlich die SONG-Taste. Nach erfolgreichem Start des Instrumentes können Sie beide Tasten wieder loslassen. Alle User-Songs sind nun gelöscht.
2. Um einen einzelnen Song oder einzelne Spuren zu löschen aktivieren Sie den Aufnahmemodus. Hierzu drücken Sie 2x RECORD. Unter der Tempoangabe im Display blinken nun vier Pfeile. Drücken Sie RECORD für ca. zwei Sekunden. Wählen Sie nun TRACK 1, TRACK 2 oder TRACK 3. Das LCD Display zeigt „Delete?“.
3. Drücken Sie + um das Löschen zu bestätigen oder – um den Vorgang abzubrechen.



## Vorgespeicherte Songs

### Wiedergabe

1. Drücken Sie SONG um den Songmodus zu aktivieren.
2. Wählen Sie mit Hilfe von + / - den gewünschten Song aus und bestätigen Sie diesen mit START/STOP.



## Lernmodus

1. Drücken Sie LESSON.
2. Wählen Sie mit Hilfe von LEFT / RIGHT die gewünschte Hand aus.
3. Wählen Sie den gewünschten Modus mit Hilfe mehrmaligen Drücken des LESSON Knopfes aus.
4. Bestätigen Sie den Modus mit START/STOP.



Hinweis: Dieser Modus funktioniert nur im Songmodus während einer Wiedergabe eines Songs.

## MP3-Wiedergabe

Die nebenstehende Grafik zeigt die Bedienmöglichkeiten bei der MP3-Wiedergabe.

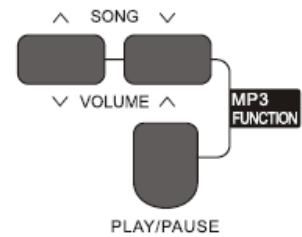

## Stimmenliste

| Classify             | No. | Full english Name                 | English Abbr |
|----------------------|-----|-----------------------------------|--------------|
| Piano                | 1   | Stereo Grand Piano                | StGrdPno     |
| Piano                | 2   | Acoustic Grand Piano (wide) 1     | GrandPnW     |
| Piano                | 3   | Acoustic Grand Piano (dark)       | GrandPnD     |
| Piano                | 4   | Octave Piano 1                    | OctPno1      |
| Piano                | 5   | Octave Piano 2                    | OctPno2      |
| Piano                | 6   | Piano & Strings                   | Pno&Str      |
| Piano                | 7   | Piano & Choir                     | Pno&Cho      |
| Piano                | 8   | Acoustic Grand Piano              | GrandPno     |
| Piano                | 9   | Stereo Bright Piano               | StBrnPno     |
| Piano                | 10  | Bright Acoustic Piano             | BritePno     |
| Piano                | 11  | Bright Acoustic Piano (wide) 1    | BritePnW     |
| Piano                | 12  | Chorus Piano                      | ChoruPno     |
| Piano                | 13  | Electric Grand Piano              | E.Grand      |
| Piano                | 14  | Electric Grand Piano (wide)       | E.GrandW     |
| Piano                | 15  | Stereo Honk-Tonk                  | StHonkTo     |
| Piano                | 16  | Honky-tonk Piano                  | HnkyTonk     |
| Piano                | 17  | Honky-tonk Piano (wide) 1         | HnyTonkW     |
| Piano                | 18  | Stereo Hard Electric Piano        | StHarEp      |
| Piano                | 19  | Detuned Electric Piano 1          | DetunEP1     |
| Piano                | 20  | Detuned Electric Piano 2          | DetunEP2     |
| Piano                | 21  | Electric Piano 1                  | E.Piano1     |
| Piano                | 22  | Electric Piano 2                  | E.Piano2     |
| Piano                | 23  | Electric Piano (wide) 1           | EPnoW1       |
| Piano                | 24  | Electric Piano (wide) 2           | EPnoW2       |
| Piano                | 25  | EP Legend                         | EPLegend     |
| Piano                | 26  | EP Phase                          | EPPhase      |
| Piano                | 27  | 60's Electric Piano               | 60'sEP       |
| Piano                | 28  | Electric Piano 1 (velocity mix)   | E.PnoV1      |
| Piano                | 29  | Electric Piano 2 (velocity mix)   | E.PnoV2      |
| Piano                | 30  | Velocity Crossfade Electric Piano | VeCrosEP     |
| Piano                | 31  | Layered Electric Piano 1          | LayerEP1     |
| Piano                | 32  | Layered Electric Piano 2          | LayerEP2     |
| Piano                | 33  | Nylon Electric Piano              | NylonEP      |
| Piano                | 34  | Warm Electric Piano               | WarmEP       |
| Piano                | 35  | Grand Harpsichord                 | GraHarps     |
| Piano                | 36  | Harpsichord 1                     | Harpsi       |
| Piano                | 37  | Harpsichord 2                     | Harpsi2      |
| Piano                | 38  | Harpsichord (wide)                | HarpsiW      |
| Piano                | 39  | Harpsichord (octave mix) 1        | HarpsiO      |
| Piano                | 40  | Harpsichord Release               | HarpsiR      |
| Piano                | 41  | Harpsichord (with key off)        | HarpsiOf     |
| Piano                | 42  | Clavi 1                           | Clavi        |
| Piano                | 43  | Clavi 2                           | Clavi 2      |
| Piano                | 44  | Clavi (wide) 1                    | ClaviW1      |
| Piano                | 45  | Clavi (wide) 2                    | ClaviW2      |
| Piano                | 46  | Clavi Wah                         | ClaviWa      |
| Piano                | 47  | Pulse Clavi                       | PulseClv     |
| Chromatic Percussion | 48  | Celesta 1                         | Celesta      |
| Chromatic Percussion | 49  | Celesta 2                         | Celesta2     |
| Chromatic Percussion | 50  | Birght Celesta                    | BirCelea     |
| Chromatic Percussion | 51  | Celesta & Sine                    | Celes&Si     |
| Chromatic Percussion | 52  | Reecho Bell                       | ReechBell    |
| Chromatic Percussion | 53  | Celesta & Music Box               | Celes&MB     |
| Chromatic Percussion | 54  | Glockenspiel 1                    | Glocken      |
| Chromatic Percussion | 55  | Glockenspiel 2                    | Glocken2     |
| Chromatic Percussion | 56  | Music Box 1                       | MusicBox     |
| Chromatic Percussion | 57  | Music Box 2                       | MusicBo2     |
| Chromatic Percussion | 58  | Music Box 3                       | MusicBo3     |
| Chromatic Percussion | 59  | Toy Box                           | ToyBox       |
| Chromatic Percussion | 60  | Music Box & Harp                  | Mbx&Harp     |
| Chromatic Percussion | 61  | Stereo Vibrapho                   | StVibes      |
| Chromatic Percussion | 62  | Rigid Vibraphone                  | RigiVibe     |

| <b>Classify</b>      | <b>No.</b> | <b>Full english Name</b>          | <b>English Abbr</b> |
|----------------------|------------|-----------------------------------|---------------------|
| Chromatic Percussion | 63         | Vibraphone 1                      | Vibra               |
| Chromatic Percussion | 64         | Vibraphone 2                      | Vibra2              |
| Chromatic Percussion | 65         | Vibraphone (wide) 1               | VibraW              |
| Chromatic Percussion | 66         | Vibraphone (wide) 2               | VibraW2             |
| Chromatic Percussion | 67         | Vibraphone & Bell                 | Bell&Vib            |
| Chromatic Percussion | 68         | Marimba 1                         | Marimba             |
| Chromatic Percussion | 69         | Marimba 2                         | Marimba2            |
| Chromatic Percussion | 70         | Marimba (wide)                    | MarimbaW            |
| Chromatic Percussion | 71         | Stereo Marimba                    | StMarim             |
| Chromatic Percussion | 72         | Marimba & Vibraphone              | Mar&Vib             |
| Chromatic Percussion | 73         | Xylophone 1                       | Xylophone           |
| Chromatic Percussion | 74         | Xylophone 2                       | Xylopho2            |
| Chromatic Percussion | 75         | Tubular Bells                     | TubulBell           |
| Chromatic Percussion | 76         | Church Bell                       | ChurBell            |
| Chromatic Percussion | 77         | Carillon                          | Carillon            |
| Chromatic Percussion | 78         | Dulcimer                          | Dulcimer            |
| Chromatic Percussion | 79         | Santur                            | Santur              |
| Organ                | 80         | Drawbar Organ 1                   | DrawbOrgan          |
| Organ                | 81         | Drawbar Organ 2                   | DrawbOrgan 2        |
| Organ                | 82         | Soft Stereo Drawbar Organ         | SfDrawOrgan         |
| Organ                | 83         | Mellow Drawbar Organ              | MellDrOr            |
| Organ                | 84         | Detuned Drawbar Organ 1           | DeDraOr             |
| Organ                | 85         | Detuned Drawbar Organ 2           | DeDraOr2            |
| Organ                | 86         | Italian 60's Organ                | 60'sOrgn            |
| Organ                | 87         | 1970 Percussive Organ             | 1970PcOr            |
| Organ                | 88         | Percussive Organ 1                | PercOrgn1           |
| Organ                | 89         | Percussive Organ 2                | PercOrg2            |
| Organ                | 90         | Light Click Organ                 | LClickOr            |
| Organ                | 91         | Detuned Percussive Organ          | DePerOrg            |
| Organ                | 92         | Stereo Rotary Organ               | StRotaOr            |
| Organ                | 93         | Rock Organ                        | RockOrgn            |
| Organ                | 94         | Rotary Organ                      | RotaOrgn            |
| Organ                | 95         | Slow Rotary Organ                 | SloRotOr            |
| Organ                | 96         | Detuned Church Organ              | DeChuOrg            |
| Organ                | 97         | Church Organ 1                    | ChurOrgn            |
| Organ                | 98         | Church Organ 2                    | ChurOrg2            |
| Organ                | 99         | Church Organ (octave mix)         | ChurOrgO            |
| Organ                | 100        | Reed Organ                        | ReedOrgn            |
| Organ                | 101        | Puff Organ                        | PuffOrgn            |
| Organ                | 102        | Accordion 1                       | Accordion           |
| Organ                | 103        | Accordion 2                       | Accordin2           |
| Organ                | 104        | Accordion 3                       | Accordin3           |
| Organ                | 105        | Mustte                            | Mustte              |
| Organ                | 106        | Accord It Solo                    | AccordSo            |
| Organ                | 107        | Sweet Harmonica                   | SwetHarm            |
| Organ                | 108        | Harmonica 1                       | Harmonica           |
| Organ                | 109        | Harmonica 2                       | Harmonic2           |
| Organ                | 110        | Tango Accordion                   | TangoAcd            |
| Guitar               | 111        | Acoustic Guitar (nylon) 1         | NylonGtr            |
| Guitar               | 112        | Acoustic Guitar (nylon) 2         | NylonGt2            |
| Guitar               | 113        | Acoustic Guitar (nylon + key off) | NylGtrOf            |
| Guitar               | 114        | Ukulele                           | Ukulele             |
| Guitar               | 115        | Velocity Nylon Guitar             | NylnGtVe            |
| Guitar               | 116        | Chorus Nylon Guitar               | ChoNyGt             |
| Guitar               | 117        | Bright Nylon Guitar               | BrNyGt              |
| Guitar               | 118        | Acoustic Guitar (steel) 1         | SteelGtr            |
| Guitar               | 119        | Acoustic Guitar (steel) 2         | SteelGt2            |
| Guitar               | 120        | Steel Guitar with Body Sound      | SteelBdy            |
| Guitar               | 121        | Tremolo Steel Guitar              | TremGt              |
| Guitar               | 122        | Mandolin                          | Mandolin            |
| Guitar               | 123        | 12-Strings Guitar                 | 12StrGtr            |
| Guitar               | 124        | Chorus Steel Guitar               | ChoSteGt            |

| <b>Classify</b>                  | <b>No.</b> | <b>Full english Name</b>            | <b>English Abbr</b> |
|----------------------------------|------------|-------------------------------------|---------------------|
| Guitar                           | 125        | Nylon & Steel Guitar                | Ny&SteGt            |
| Guitar                           | 126        | Stereo Steel Guitar                 | StSteGt             |
| Guitar                           | 127        | Steel Guitar Bend                   | GtBend              |
| Guitar                           | 128        | Steel Guitar Harmonics              | GtHarm              |
| Guitar                           | 129        | Velocity Steel Guitar 1             | VelSte1             |
| Guitar                           | 130        | Velocity Steel Guitar 2             | VelSte2             |
| Guitar                           | 131        | Velocity Steel Guitar 3             | VelSte3             |
| Guitar                           | 132        | Electric Guitar (jazz) 1            | JazzGtr             |
| Guitar                           | 133        | Electric Guitar (jazz) 2            | JazzGt2             |
| Guitar                           | 134        | Electric Guitar (pedal steel)       | PedalGtr            |
| Guitar                           | 135        | Mellow Guitar                       | MellGt              |
| Guitar                           | 136        | Velocity Jazz Guitar                | JazzGtVe            |
| Guitar                           | 137        | Jazz Guitar Detuned                 | JazzGtDt            |
| Guitar                           | 138        | Mid Tone Guitar                     | MidTonGt            |
| Guitar                           | 139        | Electric Guitar (clean) 1           | CleanGtr            |
| Guitar                           | 140        | Electric Guitar (clean) 2           | CleanGtr2           |
| Guitar                           | 141        | Stereo Clean Guitar                 | StCleGtr            |
| Guitar                           | 142        | Velocity Clean Guitar               | CleGtVel            |
| Guitar                           | 143        | Electric Guitar (detuned clean)     | DetClnGt            |
| Guitar                           | 144        | Electric Guitar (muted velo-sw)     | MutVelGt            |
| Guitar                           | 145        | Electric Guitar (muted)             | MutedGtr            |
| Guitar                           | 146        | Electric Guitar (funky cutting)     | FunkGt              |
| Guitar                           | 147        | Jazz Man                            | JazzMan             |
| Guitar                           | 148        | Stereo Muted Guitar                 | StMuGt              |
| Guitar                           | 149        | Guitar Pinch                        | GtPinch             |
| Guitar                           | 150        | Overdriven Guitar                   | Overdrive           |
| Guitar                           | 151        | Distortion Guitar 1                 | DistGt              |
| Guitar                           | 152        | Distortion Guitar 2                 | DistGtr2            |
| Guitar                           | 153        | Distortion Guitar (with feedback) 1 | FeedbkGt            |
| Guitar                           | 154        | Distorted Rhythm Guitar             | DistRyth            |
| Guitar                           | 155        | 5th Distortion                      | 5thDist             |
| Guitar                           | 156        | Stereo Distorted Guitar             | StDistor            |
| Guitar                           | 157        | Guitar Feedback                     | GtFedbk             |
| Guitar                           | 158        | Guitar Harmonics                    | GtrHarmo            |
| Bass                             | 159        | Acoustic Bass 1                     | AcoBass             |
| Bass                             | 160        | Acoustic Bass 2                     | AcoBass2            |
| Bass                             | 161        | Jazz Style                          | JazzSty             |
| Bass                             | 162        | A.Bass & Mute G.T.                  | Ba&GtMu             |
| Bass                             | 163        | Resonant Bass                       | ResBass             |
| Bass                             | 164        | Wah Bass 1                          | WahBass1            |
| Bass                             | 165        | Electric Bass (finger) 1            | FngrBass            |
| Bass                             | 166        | Electric Bass (finger) 2            | FngrBas2            |
| Bass                             | 167        | Electric Bass (finger) 3            | FngrBas3            |
| Bass                             | 168        | Finger Slap Bass                    | FngrSlap            |
| Bass                             | 169        | Electric Bass (pick) 1              | PickBass            |
| Bass                             | 170        | Electric Bass (pick) 2              | PickBas2            |
| Bass                             | 171        | Fretless Bass 1                     | Fretless            |
| Bass                             | 172        | Fretless Bass 2                     | Fretless2           |
| Bass                             | 173        | Slap Bass 1                         | SlapBass            |
| Bass                             | 174        | Slap Bass 2                         | SlapBass2           |
| Bass                             | 175        | Synth Bass 1                        | SynBass             |
| Bass                             | 176        | Synth Bass 2                        | SynBass2            |
| Bass                             | 177        | Synth Bass 3 (resonance)            | ResoBass            |
| Bass                             | 178        | Synth Bass 4 (attack)               | AtackBass           |
| Bass                             | 179        | Synth Bass (warm)                   | WarmBass            |
| Bass                             | 180        | Clavi Bass                          | ClavBass            |
| Bass                             | 181        | Hammer                              | Hammer              |
| Bass                             | 182        | Synth Bass (rubber)                 | RubbBass            |
| Bass                             | 183        | Attack Pulse                        | AtackPls            |
| Strings & Orchestral Instruments | 184        | The Violin                          | TheVin              |
| Strings & Orchestral Instruments | 185        | Violin 1                            | Violin              |

| <b>Classify</b>                  | <b>No.</b> | <b>Full english Name</b>     | <b>English Abbr</b> |
|----------------------------------|------------|------------------------------|---------------------|
| Strings & Orchestral Instruments | 186        | Violin 2                     | Violin2             |
| Strings & Orchestral Instruments | 187        | Violin (slow attack)         | SlViolin            |
| Strings & Orchestral Instruments | 188        | Soft Violin                  | SoftVin             |
| Strings & Orchestral Instruments | 189        | Viola 1                      | Viola               |
| Strings & Orchestral Instruments | 190        | Viola 2                      | Viola2              |
| Strings & Orchestral Instruments | 191        | Cello 1                      | Cello               |
| Strings & Orchestral Instruments | 192        | Cello 2                      | Cello2              |
| Strings & Orchestral Instruments | 193        | Celloen 16'                  | Celloen             |
| Strings & Orchestral Instruments | 194        | Contrabass 1                 | Contrabs            |
| Strings & Orchestral Instruments | 195        | Contrabass 2                 | Contrbs2            |
| Strings & Orchestral Instruments | 196        | Tremolo Strings 1            | TremStr             |
| Strings & Orchestral Instruments | 197        | Tremolo Strings 2            | TremStr2            |
| Strings & Orchestral Instruments | 198        | Pizzicato Strings 1          | PizzStr             |
| Strings & Orchestral Instruments | 199        | Pizzicato Strings 2          | PizzStr2            |
| Strings & Orchestral Instruments | 200        | Orchestral Harp 1            | Harp                |
| Strings & Orchestral Instruments | 201        | Orchestral Harp 2            | Harp2               |
| Strings & Orchestral Instruments | 202        | Timpani 1                    | Timpani             |
| Strings & Orchestral Instruments | 203        | Timpani 2                    | Timpani2            |
| Ensemble                         | 204        | String Ensembles 1           | Strings1            |
| Ensemble                         | 205        | String Ensembles 2           | Strings2            |
| Ensemble                         | 206        | Synth Strings 1              | SynStrs1            |
| Ensemble                         | 207        | Synth Strings 2              | SynStrs2            |
| Ensemble                         | 208        | Synth Strings 3              | SynStrs3            |
| Ensemble                         | 209        | Synth Strings 4              | SynStrs4            |
| Ensemble                         | 210        | Stereo Slow Strings          | SSlowStr            |
| Ensemble                         | 211        | Strings and Brass            | Str&Bras            |
| Ensemble                         | 212        | Legato Strings               | LegatStr            |
| Ensemble                         | 213        | Orchestra                    | Orchstr             |
| Ensemble                         | 214        | 60's Strings                 | 60'sStr             |
| Ensemble                         | 215        | Solo Strings                 | SoloStr             |
| Ensemble                         | 216        | Choir Aahs 1                 | ChoirAah            |
| Ensemble                         | 217        | Choir Aahs 2                 | ChoirAh2            |
| Ensemble                         | 218        | Humming                      | Humming             |
| Ensemble                         | 219        | Voice Oohs                   | VoiceOoh            |
| Ensemble                         | 220        | Analog Voice                 | AnaVoice            |
| Ensemble                         | 221        | Synth Voice                  | SynVoice            |
| Ensemble                         | 222        | Bass Hit Plus                | BassHit             |
| Ensemble                         | 223        | Orchestra Hit 1              | OrchHit             |
| Ensemble                         | 224        | Orchestra Hit 2              | OrchHi2             |
| Ensemble                         | 225        | Euro Hit                     | EuroHit             |
| Ensemble                         | 226        | 6th Hit                      | 6thHit              |
| Brass                            | 227        | Trumpet 1                    | Trumpet             |
| Brass                            | 228        | Trumpet 2                    | Trumpet2            |
| Brass                            | 229        | Trumpet 3                    | Trumpet3            |
| Brass                            | 230        | Dark Trumpet Soft            | DarkTrp             |
| Brass                            | 231        | Sweet Trumpet                | SweetTp             |
| Brass                            | 232        | Trombone 1                   | Trombone            |
| Brass                            | 233        | Trombone 2                   | Trmbone2            |
| Brass                            | 234        | Bright Trombone              | BritBone            |
| Brass                            | 235        | Tuba 1                       | Tuba                |
| Brass                            | 236        | Tuba 2                       | Tuba2               |
| Brass                            | 237        | Muted Trumpet 1              | MuteTrp1            |
| Brass                            | 238        | Muted Trumpet 2              | MuteTrp2            |
| Brass                            | 239        | French Horn 1                | FrHorn              |
| Brass                            | 240        | French Horn 2 (warm)         | FrHorn2             |
| Brass                            | 241        | Brass Section 1              | Brass               |
| Brass                            | 242        | Brass Section 2 (octave mix) | Brass2              |
| Brass                            | 243        | Brass Section 3              | Brass3              |
| Brass                            | 244        | Brass Section 4              | Brass4              |
| Brass                            | 245        | Brass Section 5              | Brass5              |
| Brass                            | 246        | Brass Band                   | BrasBand            |

| <b>Classify</b> | <b>No.</b> | <b>Full english Name</b>   | <b>English Abbr</b> |
|-----------------|------------|----------------------------|---------------------|
| Brass           | 247        | Bright Brass Section       | BrBraSec            |
| Brass           | 248        | Brass & Strings            | Bras&Str            |
| Brass           | 249        | Synth Brass 1              | SynBras1            |
| Brass           | 250        | Synth Brass 2              | SynBras2            |
| Brass           | 251        | Synth Brass 3              | SynBras3            |
| Brass           | 252        | Synth Brass 4              | SynBras4            |
| Brass           | 253        | Analog Synth Brass 1       | AnaBras1            |
| Brass           | 254        | Analog Synth Brass 2       | AnaBras2            |
| Brass           | 255        | Jump Brass                 | JumpBras            |
| Brass           | 256        | Synth Brass & Strings 1    | SyBr&St1            |
| Reed            | 257        | Soprano Sax 1              | SprnoSax            |
| Reed            | 258        | Soprano Sax 2              | SprnSax2            |
| Reed            | 259        | Sweet Soprano Sax          | SweSpSax            |
| Reed            | 260        | Alto Sax                   | AltoSax             |
| Reed            | 261        | Soft Alto Sax              | SoftAlto            |
| Reed            | 262        | Tenor Sax 1                | TenorSax            |
| Reed            | 263        | Tenor Sax 2                | TenoSax2            |
| Reed            | 264        | Baritone Sax               | BariSax             |
| Reed            | 265        | Sweet Oboe                 | SwetOboe            |
| Reed            | 266        | Oboe 1                     | Oboe                |
| Reed            | 267        | English Horn 1             | EngHorn             |
| Reed            | 268        | Bassoon 1                  | Bassoon             |
| Reed            | 269        | Clarinet 1                 | Clarinet            |
| Reed            | 270        | Clarinet 2                 | Clarinet2           |
| Pipe            | 271        | Piccolo                    | Piccolo             |
| Pipe            | 272        | Flute                      | Flute               |
| Pipe            | 273        | Sweet Flute                | SweeFlut            |
| Pipe            | 274        | Recorder                   | Recorder            |
| Pipe            | 275        | Sweet Pan Flute            | SwPanFu             |
| Pipe            | 276        | Pan Flute                  | PanFlute            |
| Pipe            | 277        | Blown Bottle               | Bottle              |
| Pipe            | 278        | Shakuhachi                 | Shakhchi            |
| Pipe            | 279        | Whistle 1                  | Whistle             |
| Pipe            | 280        | Whistle 2                  | Whistle2            |
| Pipe            | 281        | Ocarina                    | Ocarina             |
| Synth Lead      | 282        | Lead 1 (square)            | SquareLd            |
| Synth Lead      | 283        | Square                     | Square              |
| Synth Lead      | 284        | Lead 1b (sine)             | SineLead            |
| Synth Lead      | 285        | Square Lead 1              | SquarLd1            |
| Synth Lead      | 286        | Lead 1a (square 2)         | SquarLd2            |
| Synth Lead      | 287        | Lead 2a (sawtooth 2)       | SawLead2            |
| Synth Lead      | 288        | Lead 2d (sequenced analog) | SquAnaLd            |
| Synth Lead      | 289        | Lead 2 (sawtooth)          | SawLead1            |
| Synth Lead      | 290        | Lead 2b (saw + pulse)      | SawPlsLd            |
| Synth Lead      | 291        | Lead 2c (double sawtooth)  | DubSawLd            |
| Synth Lead      | 292        | Lead 3 (calliope)          | CalliopLd           |
| Synth Lead      | 293        | Lead 4 (chiff)             | ChiffLd             |
| Synth Lead      | 294        | Lead 5 (charang)           | CharanLd            |
| Synth Lead      | 295        | Lead 5a (wire lead)        | WireLead            |
| Synth Lead      | 296        | Lead 6 (voice)             | VoiceLd             |
| Synth Lead      | 297        | Lead 7 (fifths)            | FifthsLd            |
| Synth Lead      | 298        | Lead 8 (bass + lead)       | BassLead            |
| Synth Lead      | 299        | Lead 8a (soft wrl)         | SftWrILd            |
| Synth Pad       | 300        | Pad 1 (new age)            | NewAgePd            |
| Synth Pad       | 301        | New Year Pad               | NewYrPd             |
| Synth Pad       | 302        | Pad 2 (warm)               | WarmPad             |
| Synth Pad       | 303        | Pad 2a (sine pad)          | SinePad             |
| Synth Pad       | 304        | Pad 3 (polysynth) 1        | PolySyPd            |
| Synth Pad       | 305        | Pad 4 (choir)              | ChoirPad            |
| Synth Pad       | 306        | Pad 4a (itopia)            | ItopiaPd            |
| Synth Pad       | 307        | Pad 5 (bowed) 1            | BowedPad            |

| <b>Classify</b>     | <b>No.</b> | <b>Full english Name</b>     | <b>English Abbr</b> |
|---------------------|------------|------------------------------|---------------------|
| Synth Pad           | 308        | Pad 6 (metallic) 1           | MetalPad            |
| Synth Pad           | 309        | Pad 7 (halo) 1               | HaloPad             |
| Synth Pad           | 310        | Pad 8 (sweep) 1              | SweepPad            |
| Synth Pad           | 311        | FX 1 (rain)                  | FXRain              |
| Synth Pad           | 312        | FX 2 (soundtrack)            | Soundtrk            |
| Synth Pad           | 313        | FX 3a (synth mallet)         | SynMalet            |
| Synth Pad           | 314        | FX 3 (crystal)               | Crystal             |
| Synth Pad           | 315        | FX 4 (atmosphere)            | Atmosphr            |
| Synth Pad           | 316        | Warm Air                     | WarmAir             |
| Synth Pad           | 317        | FX 5 (brightness)            | Bright              |
| Synth Pad           | 318        | FX 6 (goblins)               | Goblins             |
| Synth Pad           | 319        | FX 7 (echoes) 1              | Echoes              |
| Synth Pad           | 320        | FX 7a (echo bell) 1          | EchoBell            |
| Synth Pad           | 321        | FX 7b (echo pan)             | EchoPan             |
| Synth Pad           | 322        | FX 8 (sci-fi)                | Sci-Fi              |
| Ethnic Misc.        | 323        | Sitar 1                      | Sitar               |
| Ethnic Misc.        | 324        | Sitar 2 (bend)               | Sitar2              |
| Ethnic Misc.        | 325        | Banjo                        | Banjo               |
| Ethnic Misc.        | 326        | Shamisen                     | Shamisen            |
| Ethnic Misc.        | 327        | Koto                         | Koto                |
| Ethnic Misc.        | 328        | Taisho Koto                  | TaishoKt            |
| Ethnic Misc.        | 329        | Kalimba                      | Kalimba             |
| Ethnic Misc.        | 330        | Bag Pipe                     | Bagpipe             |
| Ethnic Misc.        | 331        | Fiddle                       | Fiddle              |
| Ethnic Misc.        | 332        | Shanai                       | Shanai              |
| Percussive          | 333        | Tinkle Bell                  | TnklBell            |
| Percussive          | 334        | Steel Drums                  | SteelDrm            |
| Percussive          | 335        | Woodblock                    | WoodBlok            |
| SFX                 | 336        | Seashore                     | Seashore            |
| SFX                 | 337        | Thunder                      | Thunder             |
| SFX                 | 338        | Telephone Ring 1             | Telephone           |
| SFX                 | 339        | Applause                     | Applause            |
| Combined Voice      | 340        | Stereo Piano & Strings Pad   | StPn&Str            |
| Combined Voice      | 341        | Stereo Piano & Choir         | StPn&Cho            |
| Combined Voice      | 342        | Stereo Piano & Synth Strings | StPn&Syn            |
| Combined Voice      | 343        | Stereo Piano & Warm Pad      | StPn&Pad            |
| Combined Voice      | 344        | Rock Organ & Strings         | RoOr&Str            |
| Combined Voice      | 345        | Steel Guitar & Warm Pad      | StGt&Pad            |
| Combined Voice      | 346        | Orchestra                    | Orchest             |
| Combined Voice      | 347        | Full Strings 1               | FullStr1            |
| Combined Voice      | 348        | Symphonic                    | Symphon             |
| Chinese Instruments | 349        | GuZheng                      | GuZheng             |
| Chinese Instruments | 350        | PiPa                         | PiPa                |
| Chinese Instruments | 351        | ErHu 1                       | ErHu1               |
| Chinese Instruments | 352        | Bandi                        | Bandi               |
| Chinese Instruments | 353        | Hulusi                       | Hulusi              |
| Chinese Instruments | 354        | LuSheng 1                    | LuShen1             |
| Chinese Instruments | 355        | SuoNa                        | SuoNa               |
| Chinese Instruments | 356        | PaiXiao                      | PaiXiao             |
| Drum Set            | 357        | Standard Set                 | StandSet            |
| Drum Set            | 358        | Room Set                     | RoomSet             |
| Drum Set            | 359        | Power Set                    | PowerSet            |
| Drum Set            | 360        | Jazz Set                     | JazzSet             |

## Styles Liste

| Classify | No. | Full english Name | English Abbr |
|----------|-----|-------------------|--------------|
| 8 BEAT   | 1   | 8Beat Piano       | 8BtPiano     |
| 8 BEAT   | 2   | 8Beat 1           | 8Beat1       |
| 8 BEAT   | 3   | 8Beat Shuffle     | 8BtShufl     |
| 8 BEAT   | 4   | Guitar Pop 1      | GtPop1       |
| 8 BEAT   | 5   | 8Beat Hip Hop     | 8BtHiHop     |
| 8 BEAT   | 6   | 8Beat R&B         | 8BeatR&B     |
| 8 BEAT   | 7   | 8Beat Pop         | 8BtPop       |
| 8 BEAT   | 8   | Pop Funk 1        | PopFunk1     |
| 8 BEAT   | 9   | Rhythm & Beat 1   | Rhy&Bt1      |
| 8 BEAT   | 10  | 8Beat Disco 1     | 8BtDisc1     |
| 8 BEAT   | 11  | 8Beat Rock        | 8BtRock      |
| 8 BEAT   | 12  | 8Beat 2           | 8Beat2       |
| 8 BEAT   | 13  | Sweet Beat        | SweetBt      |
| 8 BEAT   | 14  | 8Beat Dance       | 8BtDance     |
| 8 BEAT   | 15  | 8Beat 3           | 8Beat3       |
| 8 BEAT   | 16  | 60's 8Beat        | 60's8Bt      |
| 16 BEAT  | 17  | 16Beat 1          | 16Beat1      |
| 16 BEAT  | 18  | 16Beat Funk 1     | 16BtFuk1     |
| 16 BEAT  | 19  | 16Beat Ballad 1   | 16BtBld1     |
| 16 BEAT  | 20  | 16Beat R&B        | 16BtR&B      |
| 16 BEAT  | 21  | Pop 16Beat 1      | Pop16Bt1     |
| 16 BEAT  | 22  | 16Beat Dance      | 16BDanc      |
| 16 BEAT  | 23  | 16Beat 2          | 16Beat2      |
| 16 BEAT  | 24  | Modern 16Beat     | Modrn16B     |
| 16 BEAT  | 25  | 16Beat Hot        | 16BtHot      |
| 16 BEAT  | 26  | 16Beat Modern     | 16BModr      |
| 16 BEAT  | 27  | 16Beat 3          | 16Beat3      |
| 16 BEAT  | 28  | Cool Beat         | CoolBeat     |
| 16 BEAT  | 29  | 16Beat Ballad 2   | 16BtBld2     |
| 16 BEAT  | 30  | 16Beat 4          | 16Beat4      |
| 16 BEAT  | 31  | Pop Shuffle       | PopShufl     |
| POP      | 32  | Pop Rock 1        | PopRock1     |
| POP      | 33  | Pop Dance 1       | PopDanc1     |
| POP      | 34  | Pop Fusion        | PopFusn      |
| POP      | 35  | Analog Night 1    | AnalgNt1     |
| POP      | 36  | 6/8 Pop           | 6/8Pop       |
| POP      | 37  | Brit. Pop 1       | BritPop1     |
| POP      | 38  | Brit. Pop 2       | BritPop2     |
| POP      | 39  | Pop Hit           | PopHit       |
| POP      | 40  | Fusion Shuffle    | FusShufl     |
| POP      | 41  | Pop Beat          | PopBeat      |
| POP      | 42  | Soft Beat         | SoftBeat     |
| POP      | 43  | 60's Pop          | 60'sPop      |
| POP      | 44  | Sting Latin       | StigLatn     |
| BALLAD   | 45  | R&B Ballad 1      | R&BBad1      |
| BALLAD   | 46  | Guitar Ballad     | GtBallad     |
| BALLAD   | 47  | Ballad Rock       | BalladRk     |
| BALLAD   | 48  | Piano Pop         | PianoPop     |
| BALLAD   | 49  | Soft Ballad       | SoftBald     |
| BALLAD   | 50  | Natural Ballad    | NatuBld      |
| BALLAD   | 51  | Love Ballad       | LoveBld      |
| BALLAD   | 52  | Easy Ballad       | EasyBld      |
| BALLAD   | 53  | Slow Ballad       | SlowBald     |
| BALLAD   | 54  | Folk Ballad       | FolkBld      |
| BALLAD   | 55  | Pop Ballad 1      | PopBld1      |
| BALLAD   | 56  | EP Ballad         | EPBallad     |
| ROCK     | 57  | Rock              | Rock         |
| ROCK     | 58  | New Wave          | NewWave      |
| ROCK     | 59  | Ska               | Ska          |
| ROCK     | 60  | Slow Rock         | SlowRock     |
| ROCK     | 61  | 70's Rock & Roll  | 70'sRock     |
| ROCK     | 62  | Folk Rock         | FolkRock     |



| <b>Classify</b> | <b>No.</b> | <b>Full english Name</b> | <b>English Abbr</b> |
|-----------------|------------|--------------------------|---------------------|
| ROCK            | 63         | Soft Rock                | SoftRock            |
| ROCK            | 64         | Easy Rock                | EasyRock            |
| ROCK            | 65         | New Shuffle              | NewShuffl           |
| ROCK            | 66         | Rock Hip Hop             | RkHipHop            |
| ROCK            | 67         | Rock & Roll 1            | R'N'R1              |
| ROCK            | 68         | Rock & Roll 2            | R'N'R2              |
| BALLROOM        | 69         | Tango 1                  | Tango1              |
| BALLROOM        | 70         | Spain Matador            | Matador             |
| BALLROOM        | 71         | Twist 1                  | Twist1              |
| BALLROOM        | 72         | Big Band Fox             | BandFox             |
| BALLROOM        | 73         | Tango 2                  | Tango2              |
| BALLROOM        | 74         | Slow Fox                 | SlowFox             |
| BALLROOM        | 75         | Slow Waltz 1             | SlowWlz1            |
| BALLROOM        | 76         | Swing Fox                | SwingFox            |
| BALLROOM        | 77         | Salsa 1                  | Salsa1              |
| BALLROOM        | 78         | Cha Cha 1                | ChaCha1             |
| BALLROOM        | 79         | Cha Cha 2                | ChaCha2             |
| BALLROOM        | 80         | Beguine 1                | Beguine1            |
| BALLROOM        | 81         | Beguine 2                | Beguine2            |
| BALLROOM        | 82         | Rumba 1                  | Rumba1              |
| BALLROOM        | 83         | Samba 1                  | Samba1              |
| BALLROOM        | 84         | Jive                     | Jive                |
| BALLROOM        | 85         | Fox Trot                 | FoxTrot             |
| DANCE           | 86         | Techno 1                 | Techno1             |
| DANCE           | 87         | Hip Hop 1                | HipHop1             |
| DANCE           | 88         | Dream Dance              | DrnDance            |
| DANCE           | 89         | House                    | House               |
| DANCE           | 90         | Down Beat                | DownBeat            |
| DANCE           | 91         | Progressive              | Progress            |
| DANCE           | 92         | Rap 1                    | Rap1                |
| DANCE           | 93         | Disco                    | Disco               |
| DANCE           | 94         | Soft Disco               | SoftDisc            |
| DANCE           | 95         | Disco Party              | DscParty            |
| DANCE           | 96         | 70's Disco               | 70'sDisc            |
| DANCE           | 97         | Club Dance               | ClubDanc            |
| DANCE           | 98         | Euro Dance               | EuroDanc            |
| DANCE           | 99         | Hip Hop 2                | HipHop2             |
| SOUL & FUNK     | 100        | Funk 1                   | Funk1               |
| SOUL & FUNK     | 101        | Classic Funk             | ClasFunk            |
| SOUL & FUNK     | 102        | Gospel Swing             | GopSwing            |
| SOUL & FUNK     | 103        | Gospel                   | Gospel              |
| SOUL & FUNK     | 104        | Funk 2                   | Funk2               |
| SOUL & FUNK     | 105        | Electric Funk            | ElecFunk            |
| SOUL & FUNK     | 106        | Groove Funk              | GrooveFk            |
| SOUL & FUNK     | 107        | Cool Funky               | ColFunky            |
| SOUL & FUNK     | 108        | Jazz Funk                | JazzFunk            |
| SOUL & FUNK     | 109        | Groove                   | Groove              |
| SOUL & FUNK     | 110        | Soul                     | Soul                |
| SOUL & FUNK     | 111        | Hip Hop Beat             | HipHopBt            |
| SOUL & FUNK     | 112        | R&B                      | R&B                 |
| SOUL & FUNK     | 113        | Soul Beat                | SoulBeat            |
| SWING & JAZZ    | 114        | Latin Jazz 1             | LatinJz1            |
| SWING & JAZZ    | 115        | Big Band                 | BigBand             |
| SWING & JAZZ    | 116        | Dixieland 1              | Dixland1            |
| SWING & JAZZ    | 117        | Broadway Big Band        | BwayBand            |
| SWING & JAZZ    | 118        | Swing                    | Swing               |
| SWING & JAZZ    | 119        | Latin Jazz 2             | LatinJz2            |
| SWING & JAZZ    | 120        | Fusion                   | Fusion              |
| SWING & JAZZ    | 121        | Acid Jazz                | AcidJazz            |
| SWING & JAZZ    | 122        | Cool Jazz Ballad         | CoolJzBd            |
| SWING & JAZZ    | 123        | Swing Shuffle            | SwingSfl            |
| SWING & JAZZ    | 124        | Big Band Medium          | BandMid             |

| <b>Classify</b>     | <b>No.</b> | <b>Full english Name</b> | <b>English Abbr</b> |
|---------------------|------------|--------------------------|---------------------|
| COUNTRY             | 125        | Country Pop 1            | CntyPop1            |
| COUNTRY             | 126        | Bluegrass 1              | Bluegrs1            |
| COUNTRY             | 127        | Country 8Beat            | Ct8Beat             |
| COUNTRY             | 128        | Modern Country           | ModernCt            |
| COUNTRY             | 129        | Country Pop 2            | CntyPop2            |
| COUNTRY             | 130        | Bluegrass 2              | Bluegrs2            |
| COUNTRY             | 131        | 2/4 Country              | 2/4Cntry            |
| COUNTRY             | 132        | Country Quick Steps      | QuickStp            |
| COUNTRY             | 133        | Country Folk             | CntyFolk            |
| COUNTRY             | 134        | Country Shuffle          | CnyShufl            |
| Latin & Latin Dance | 135        | Bossa Nova               | BosaNov             |
| Latin & Latin Dance | 136        | Latin                    | Latin               |
| Latin & Latin Dance | 137        | Tikitikita               | Tikitkta            |
| Latin & Latin Dance | 138        | Lambada                  | Lambada             |
| Latin & Latin Dance | 139        | Pop Cha Cha 1            | PChaCha1            |
| Latin & Latin Dance | 140        | Pop Cha Cha 2            | PChaCha2            |
| Latin & Latin Dance | 141        | Salsa 2                  | Salsa2              |
| Waltz & TRADITIONAL | 142        | Waltz                    | Waltz               |
| Waltz & TRADITIONAL | 143        | Old Waltz                | OldWaltz            |
| Waltz & TRADITIONAL | 144        | English Waltz            | EngWaltz            |
| Waltz & TRADITIONAL | 145        | German Waltz             | GemWaltz            |
| Waltz & TRADITIONAL | 146        | ViennaWaltz              | VinaWtz             |
| Waltz & TRADITIONAL | 147        | Slow Waltz 2             | SlwWltz2            |
| Waltz & TRADITIONAL | 148        | Jazz Waltz               | JzWaltz             |
| Waltz & TRADITIONAL | 149        | Polka                    | Polka               |
| Waltz & TRADITIONAL | 150        | March                    | March               |
| CHINESE FOLK        | 151        | Chinese R&B 1            | ChnR&B1             |
| CHINESE FOLK        | 152        | GuangXi Folk             | GuangXi             |
| CHINESE FOLK        | 153        | Chinese Folk 1           | ChnFolk1            |
| CHINESE FOLK        | 154        | NeiMeng Folk             | NeiMFolk            |
| CHINESE FOLK        | 155        | JiangNan Folk1           | JangNan1            |
| CHINESE FOLK        | 156        | XinJiang Folk            | XJangFok            |
| CHINESE FOLK        | 157        | YangGe                   | YangGe              |
| CHINESE FOLK        | 158        | YunNan                   | YunNan              |
| CHINESE FOLK        | 159        | Jubilance                | Jubilanc            |
| CHINESE FOLK        | 160        | GuangDong                | GungDong            |

## Songlisten

| <b>Classify</b> | <b>No.</b> | <b>Full english Name</b>   | <b>English Abbr</b> |
|-----------------|------------|--|---------------------|
| FOLK & COUNTRY  | 1          | Jambalaya  | Jambalay            |
| FOLK & COUNTRY  | 2          | Ding! Dong! Merrily On High  | DingDong            |
| FOLK & COUNTRY  | 3          | Battle Hymne Of The Republic   | Battle              |
| FOLK & COUNTRY  | 4          | The Old Gray Mare  | GrayMare            |
| FOLK & COUNTRY  | 5          | American Patrol  | USPatrol            |
| FOLK & COUNTRY  | 6          | Christmas Is Coming  | IsComing            |
| FOLK & COUNTRY  | 7          | Sippin' Cider Through A Straw  | SCTStraw            |
| FOLK & COUNTRY  | 8          | Christmas Sound  | Sound               |
| GOLDEN & POP    | 9          | On London Bridge   | LdBridge            |
| GOLDEN & POP    | 10         | Are You Lonesome Tonight   | Lonesome            |
| GOLDEN & POP    | 11         | Der Deitcher's Dog   | DerDDog             |
| GOLDEN & POP    | 12         | Joy To The World   | JoyWorld            |
| GOLDEN & POP    | 13         | Silent Night   | SttNight            |
| GOLDEN & POP    | 14         | Ave Maria  | AveMaria            |
| GOLDEN & POP    | 15         | Five Hundred Miles   | FHMiles             |
| GOLDEN & POP    | 16         | Happy New Year   | HappyNY             |
| GOLDEN & POP    | 17         | It's Beginning To Look A Lot Like Christmas                              | LikeXmas            |
| GOLDEN & POP    | 18         | Jeanie With The Light Brown Hair   | LightHair           |
| GOLDEN & POP    | 19         | My Bonnie  | MyBonnie            |
| GOLDEN & POP    | 20         | Song Of The Pearlfisher  | SongOfTP            |
| CLASSICAL       | 21         | Swan   | Swan                |
| CLASSICAL       | 22         | Prelude To Act 2 (Swan Lake)   | SwanLak1            |
| CLASSICAL       | 23         | Valse (Swan lake)  | SwanLak2            |
| CLASSICAL       | 24         | The Happy Farmer   | HpFarmer            |
| CLASSICAL       | 25         | The Sleeping Beauty  | SleepBty            |
| CLASSICAL       | 26         | La Traviata  | LaTravia            |
| CLASSICAL       | 27         | Wiegenlied   | Wiegenli            |
| CLASSICAL       | 28         | Mov. 2 Adagio Non Troppo Piano Sonata No. 9 In D                         | Sonata9             |
| CLASSICAL       | 29         | Mov. 1 Andante Grazioso Piano Sonata No. 11 In A [Alla Tur Sonata 11 ca] | Sonata11            |
| CLASSICAL       | 30         | Prelude In C   | Prelude             |
| CLASSICAL       | 31         | Chinese Dance  | ChDance             |
| CLASSICAL       | 32         | Emperors Waltz   | EmprWaltz           |
| CLASSICAL       | 33         | March Militaire  | MilMar1             |
| CLASSICAL       | 34         | Symphony No. 40  | Symphony            |
| JAZZ & FUSION   | 35         | ShanZhaShu   | ShanZhaS            |
| JAZZ & FUSION   | 36         | You Are My Sunshine  | MySun               |
| JAZZ & FUSION   | 37         | June Samba   | JunSamba            |
| JAZZ & FUSION   | 38         | Funk   | Funk                |
| JAZZ & FUSION   | 39         | I Can.....   | I Can...            |
| JAZZ & FUSION   | 40         | Sea Shore  | SeaShore            |

| <b>Classify</b> | <b>No.</b> | <b>Full english Name</b>                 | <b>English Abbr</b> |
|-----------------|------------|--|---------------------|
| JAZZ & FUSION   | 41         | Guitar & Saxphone                        | Gt&Sax              |
| JAZZ & FUSION   | 42         | The Hip Hop's Night                      | HipHopNt            |
| JAZZ & FUSION   | 43         | Blue Lunch                               | BlueLunch           |
| JAZZ & FUSION   | 44         | Cobweb                                   | Cobweb              |
| JAZZ & FUSION   | 45         | Wine                                     | Wine                |
| JAZZ & FUSION   | 46         | Jazz Old Man                             | JzOldMan            |
| JAZZ & FUSION   | 47         | Dark Eyes                                | DarkEyes            |
| JAZZ & FUSION   | 48         | Carlos                                   | Carlos              |
| JAZZ & FUSION   | 49         | Sad                                      | Sad                 |
| JAZZ & FUSION   | 50         | The Jazz                                 | TheJazz             |
| PIANO           | 51         | Fur Elise                                | FurElise            |
| PIANO           | 52         | Military March                           | Mmarch              |
| PIANO           | 53         | Habanera                                 | Habanera            |
| PIANO           | 54         | Minuet                                   | Minuet              |
| PIANO           | 55         | Austria Variation                        | Avariati            |
| PIANO           | 56         | Old Macdonald Had A Farm                 | OldAFarm            |
| PIANO           | 57         | Wedding March                            | Wedding             |
| PIANO           | 58         | 2-Part Invention #13 In A Minor.B.W. lli | Invention           |
| PIANO           | 59         | Minuet In G                              | MinuetG             |
| PIANO           | 60         | Turkish March                            | TurkishM            |
| PIANO           | 61         | Hey Diddle Diddle                        | HeDiddle            |
| PIANO           | 62         | Italian Polka                            | ItaPolka            |
| PIANO           | 63         | Moseta Dance                             | MosetaDn            |
| PIANO           | 64         | Bulie Dance                              | BulieDn             |
| PIANO           | 65         | Waltz in A Flat Op.39 No.15              | Waltz 1             |
| PIANO           | 66         | Wild Rose                                | WildRose            |
| PIANO           | 67         | Away In A Manger                         | AwayInAM            |
| PIANO           | 68         | Jack & Jill                              | JackJill            |
| PIANO           | 69         | Angles We Have Heard On High             | Angles              |
| PIANO           | 70         | Waltz                                    | Waltz               |
| PIANO           | 71         | Did You Ever See A Lassie                | Lassie              |
| PIANO           | 72         | Chopsticks                               | Chopstick           |
| PIANO           | 73         | Four Little Swans                        | FLSwans             |
| PIANO           | 74         | Old France                               | OldFrance           |
| PIANO           | 75         | Jesus Saviour Pilot Me                   | PilotMe             |
| PIANO           | 76         | Eclogue                                  | Eclogue             |
| PIANO           | 77         | Santa Claus Is Coming To Town            | SantaCT             |
| PIANO           | 78         | Brave Cavalier                           | Cavalier            |
| PIANO           | 79         | America The Beautiful                    | USFair              |
| PIANO           | 80         | Music Box Dancer                         | Dancer              |

## Spezifikationen

|                         |   |
|-------------------------|---|
| Produkt                 | Funkey DP-88 II Digitalpiano (00056961 schwarz;<br>00056964 weiß; 00056965 braun)                           |
| Tastatur                | 88 Tasten (Standard),   |
| Anschlagempfindlichkeit | ja  |
| Max. Polyphonie         | 128 Noten   |
| Sounds                  | 360 Arten von Stimmen   |
| Style                   | 160 verschiedene Styles   |
| Demo                    | 80 Demolieder   |
| Effekte                 | Touch, Reverb, Chorus, Dual, Split, Function Menü,<br>Sound console   |
| Aufnahme                | Singletrack, Multitracks kombinierte Aufnahme   |
| Begleitende Steuerungen | Lautstärke Volumen, Transponieren, MP3-Funktion   |
| Begleitautomatik        | A.B.C Auto Chord, Keyboard Chord  |
| Pedal                   | Soft Pedal, Sostenuto Pedal, Sustain Pedal  |
| Anschlüsse              | Netzteilanschluss, USB(MP3) Anschluss, Output, Sustain<br>Pedal, MIDI IN/OUT Anschluss, USB(MIDI) Anschluss |
| Lautsprecher            | 2 x 15W Stereo  |
| Stromversorgung         | DC IN 12V – 15V, 2A-3A  |
| Gewicht                 | 29,40kg   |

## WEEE-Erklärung / Entsorgung



Ihr Produkt wurde mit hochwertigen Materialien und Komponenten entworfen und hergestellt, die recycelbar sind und wiederverwendet werden können. Dieses Symbol bedeutet, dass elektrische und elektronische Geräte am Ende ihrer Nutzungsdauer vom Hausmüll getrennt entsorgt werden müssen. Bitte entsorgen Sie dieses Gerät bei Ihrer örtlichen kommunalen Sammelstelle oder im Recycling Center. Bitte helfen Sie mit, die Umwelt, in der wir leben, zu erhalten.

Technische Änderungen und Änderungen im Erscheinungsbild vorbehalten. Alle Angaben entsprechen dem Stand bei Drucklegung. Für die Richtigkeit und Vollständigkeit der enthaltenen Beschreibungen, Abbildungen und Angaben übernimmt Musikhaus Kirstein GmbH keinerlei Gewähr. Abgebildete Farben und Spezifikationen können geringfügig vom Produkt abweichen. Musikhaus Kirstein GmbH - Produkte sind nur über autorisierte Händler erhältlich. Distributoren und Händler sind keine Handlungsbevollmächtigten von Musikhaus Kirstein GmbH und haben keinerlei Befugnis, die Musikhaus Kirstein GmbH in irgendeiner Weise, sei es ausdrücklich oder durch schlüssiges Handeln, rechtlich zu binden. Diese Bedienungsanleitung ist urheberrechtlich geschützt. Jede Vervielfältigung, bzw. jeder Nachdruck, auch auszugsweise, und jede Wiedergabe der Abbildungen, auch in verändertem Zustand, ist nur mit schriftlicher Zustimmung der Firma Musikhaus Kirstein GmbH gestattet.

## Herstellerangaben

### Musikhaus Kirstein GmbH

Bernbeurener Strasse 11

86956 Schongau

Telefon: 0049-8861-909494-0

Telefax: 0049-8861-909494-19

[www.kirstein.de](http://www.kirstein.de)

 **KIRSTEIN.de**

# English User manual

## **Precautions / Please read carefully before proceeding**

Always follow the basic precautions listed below to avoid the possibility of serious injury or even death from electrical shock, short-circuiting, damages, fire or other hazards.

### **Power supply / power cord (devices with power cords/power supplies):**

Only use the voltage specified as correct for the device. The required voltage is printed on the type plate of the device. Check the power cable from time to time regarding dirt, damage or other influence. Use only the included power cord / power supply or adaptor. Do not place the power chord near heat sources such as heaters or radiators, and do not excessively bend or otherwise damage the cord, place heavy objects on it, or place it in a position where anyone could walk on, trip over, or roll anything over it. Remove the electric plug from the outlet when the device is not to be used for extended periods of time, or during electrical storms. When removing the electric plug from the device or an outlet, always hold the plug itself and not the cord. Pulling by the cord can damage it. To avoid generating unwanted noise, make sure there is adequate distance (50 cm or more) between the AC power adaptor and the device. Do not cover or wrap the AC power adaptor with a cloth or blanket.

### **Location:**

When setting up the device, make sure that the AC outlet you are using is easily accessible. If some trouble or malfunction occurs, immediately turn off the power switch and disconnect the plug from the outlet. Even when the power switch is turned off, electricity is still flowing to the product all the minimum level. When you are not using the product for a long time, make sure to unplug the power cord from the wall AC outlet. Inadequate ventilation can result in overheating, possibly causing damage to the device(s), or even fire Do not expose the device to excessive dust or vibrations, or extreme cold or heat (such as in direct sunlight, near a heater, or in a car during the day) to prevent the possibility of panel disfiguration or damage to the internal components. Do not place the device in an unstable position where it might accidentally fall over. Do not block the vents. This device has ventilation holes at the bottom/rear to prevent the internal temperature from becoming too high. In particular, do not place the device on its side or upside down. Inadequate ventilation can result in overheating, possibly causing damage to the device(s), or even fire. Do not use the device in the vicinity of a TV, radio, stereo equipment, mobile phone, or other electric devices. Doing so may result in noise, both in the device itself and in the TV or radio next to it.

### **Connections and handling:**

Before connecting the device to other devices, turn off the power for all devices. Before turning the power on or off for all devices, set all volume levels to minimum. Do not use the device or headphones for a long period of time at a high or uncomfortable volume level, since this can cause permanent hearing loss. If you experience any hearing loss or ringing in the ears, consult a physician. Do not rest your weight on the device or place heavy objects on it, and avoid use excessive force on the buttons, switches or connectors. Do not open the device or attempt to disassemble the internal parts or modify them in any way. The device contains no parts where the user can do service. If it should appear to be malfunctioning, discontinue use immediately and have it inspected by qualified service personnel.

# Table of Contents

|  |           |
|--|-----------|
| <b>Panel Control&amp;Display Illustration.....</b>                         | <b>1</b>  |
| Left Panel.....  | 1         |
| LCD Display.....   | 2         |
| Right Panel.....   | 2         |
| Rear Panel.....  | 3         |
| <b>Assembly.....</b>   | <b>4</b>  |
| <b>The preparation before performance.....</b>                             | <b>6</b>  |
| Power supply.....  | 6         |
| Connect Headphone.....   | 6         |
| Connect Audio Equipment.....   | 6         |
| Connect computer.....  | 6         |
| Connect other equipments.....  | 7         |
| Connect Pedal.....   | 7         |
| Connect audio equipments.....  | 7         |
| Connect USB Equipment.....   | 7         |
| Power Switch.....  | 8         |
| Adjust Master Volume.....  | 8         |
| <b>Play voice of various kinds of instruments.....</b>                     | <b>8</b>  |
| Choose and play voice(Master voice).....                                   | 8         |
| Play two kinds of voice(Dual voice).....                                   | 8         |
| Touch response.....  | 9         |
| Transpose.....   | 9         |
| The mode of piano performance.....   | 9         |
| Metronome.....   | 10        |
| <b>Play various kinds of style of accompaniments.....</b>                  | <b>10</b> |
| Play auto accompaniment(Play only the voice part of percussion music)..... | 10        |
| Accompaniment Paragraph.....   | 10        |
| Play different accompaniment paragraphes.....                              | 11        |
| Accompaniment volume control.....  | 11        |
| Tempo.....   | 12        |
| Auto chord.....  | 12        |
| Full range Chord.....  | 12        |
| Chord close.....   | 12        |
| Chord list.....  | 12        |
| <b>Reverb.....</b>   | <b>13</b> |
| <b>Chorus.....</b>   | <b>13</b> |
| <b>Sound console.....</b>  | <b>13</b> |
| <b>Function menu.....</b>  | <b>14</b> |
| Tune setting.....  | 14        |
| Keyboard split setting.....  | 14        |
| Beat type setting.....   | 15        |
| Metronome volume setting.....  | 15        |
| Reverb depth setting.....  | 15        |
| Chorus depth setting.....  | 15        |
| MIDI receiving setting.....  | 15        |
| MIDI sending setting.....  | 15        |
| <b>Factory reset.....</b>  | <b>16</b> |
| <b>Panel registration memory setting.....</b>                              | <b>16</b> |



|   |           |
|---|-----------|
| Store setting into Registration memory..... | 16        |
| Tune out registration memory.....           | 16        |
| Choose memory bank.....                     | 16        |
| <b>Record your own songs.....</b>           | <b>17</b> |
| Start record.....                           | 17        |
| Stop record.....                            | 18        |
| Replay recorded songs.....                  | 18        |
| Delete recorded songs.....                  | 18        |
| <b>Play and control song.....</b>           | <b>18</b> |
| Appreciate songs.....                       | 18        |
| Song control.....                           | 19        |
| Songs learning mode.....                    | 19        |
| MP3 play.....                               | 20        |
| <b>Voice list .....</b>                     | <b>21</b> |
| <b>Style list .....</b>                     | <b>27</b> |
| <b>Songs list .....</b>                     | <b>30</b> |
| <b>Technical Specifications.....</b>        | <b>32</b> |

# Panel control and display illustration

## Left Panel



1. **【Master volume】** button  
Adjust volume size
2. **【Tempo v/∧】** button  
Adjust present tempo
3. **【Accompaniment volume v/∧】** button  
Adjust accompaniment volume
4. **【Auto chord】** button
5. **【Full range chord】** button
6. **【Chord close】** button
7. **【Split】** button
8. **【Touch】** button  
Choose keyboard touch curve
9. **【Function menu】** button  
Enter into function menu

### In the song mode:

10. **【↺】** Button  
Set the beginning and ending position of song paragraph loop
11. **【||】** Button  
Pause to play or continue to play the songs
12. **【⏮】** Button  
To play songs fast backward
13. **【⏭】** Button  
To play songs fast forward
14. **【▶/■】** Button  
Start or stop to play the songs

### In style mode:

10. **【Intro/Ending】** button  
Play the intro/ending of auto accompaniment
11. **【Sync】** button  
Open/Close sync function
12. **【FILL IN1】** button  
Fill in variation1
13. **【FILL IN2】** button  
Fill in variation2
14. **【Start/Stop】** button  
Start or stop to play accompaniment
15. **【Rec】** button  
Start the record function
16. **【Track1】** button  
Choose track 1 in record
17. **【Track2】** button  
Choose Track 2 in record
18. **【Track3】** button  
Choose Track 3 in record
19. **【Metronome】** button  
Open or Close metronome
20. **【Transpose v/∧】** button
21. **【Sound console】** button  
Enter into sound console menu
22. LCD display screen  
Display all important setting information about this equipment

## LCD display

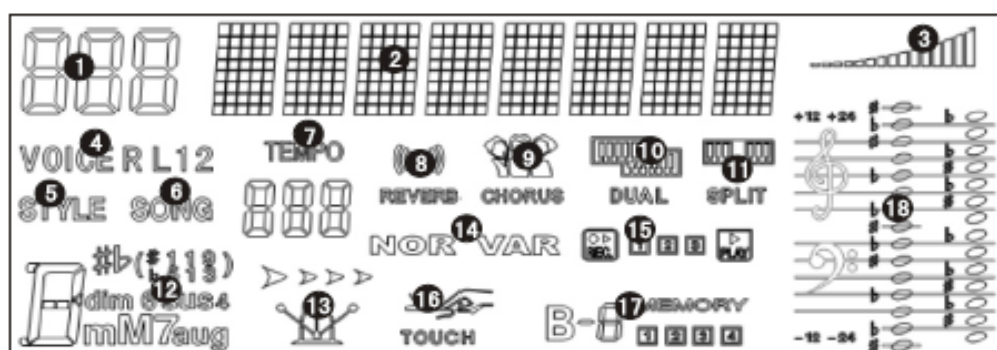

- |                              |                        |                        |
|------------------------------|------------------------|------------------------|
| 1. Digital code display area | 7. Tempo               | 13. Metronome          |
| 2. Characters display area   | 8. Reverb              | 14. FILL IN1/FILL IN2  |
| 3. Volume                    | 9. Chorus              | 15. Record/Play        |
| 4. Voice selection           | 10. Dual voice         | 16. Touch              |
| 5. Style selection           | 11. Keyboard split     | 17. State memory       |
| 6. Songs                     | 12. Chord display area | 18. Staff display area |

## Right Panel



- |  |   |
|--|---|
| 23. <b>[Piano]</b> button<br>Open or close piano performance mode  | 32. <b>[Song]</b> button<br>Switch to song function state                   |
| 24. <b>[Style]</b> button<br>Switch to style function state  | 33. <b>[Lesson]</b> button<br>Enter into learning mode                      |
| 25. <b>[Voice]</b> button<br>Switch to voice function state  | 34. <b>[Left]</b> button<br>Choose left hand voice part of learning songs   |
| 26. <b>[Number/+, -]</b> button<br>Adjust parameters   | 35. <b>[Right]</b> button<br>Choose right hand voice part of learning songs |
| 27. <b>[Dual]</b> button<br>Open or close dual voice function  | 36. <b>[Store]</b> button   |
| 28. <b>[Reverb]</b> button   | 37. <b>[M1]</b> button<br>To tune out panel setting1 promptly               |
| 29. <b>[Chorus]</b> button   | 38. <b>[M2]</b> button<br>To tune out panel setting2 promptly               |
| 30. <b>[Song<math>\wedge</math>/Volume<math>\vee</math>]</b><br>Switch to previous song MP3<br>Press this button longer time to reduce MP3 play volume | 39. <b>[Bank]</b> button<br>Switch memory bank                              |
| 31. <b>[Song<math>\vee</math>/Volume<math>\wedge</math>]</b><br>Switch to next song MP3<br>Press this button longer time to increase MP3 play volume   | 40. <b>[Play/Pause]</b> button<br>Play/ Pause MP3,                          |
|  | 41. <b>[Power]</b> button<br>Open/Close power                               |

## Rear Panel

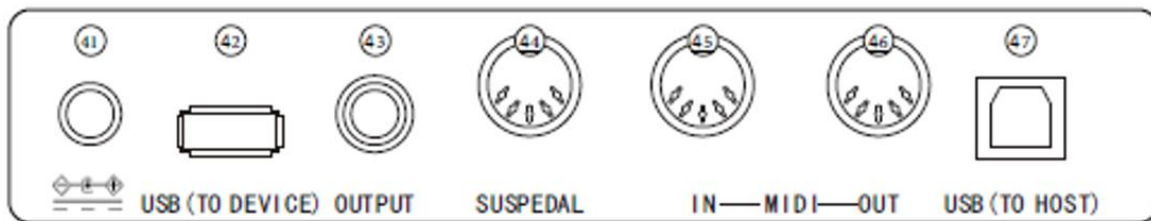

### 39.External power jack

Connect to external power adaptor

### 40.USB(MP3) equipment jack

Connect USB equipment

### 41.Audio out jack

Connect to external audio equipment

### 42.Pedal input jack

Connect to pedal

### 43.MIDI IN jack

Receiving MIDI information that was sent out by external MIDI equipment or computer







### 44.MIDI OUT jack

Sending data of this piano to computer or MIDI equipment by this jack

### 45.USB(MIDI) jack

The headphone jack is located as a single 6,3mm jack on the left side of the bottom plate of the piano.

## Assembly parts

|   |   |                                   |       |
|---|---|-----------------------------------|-------|
| ① |  | TA4*12Schrauben                   | 12stk |
| ② |  | M6*50Schrauben                    | 12stk |
| ③ |  | M6*20Schrauben                    | 4stk  |
| ④ |  | Hammermuttern                     | 8stk  |
| ⑤ |  | Winkelverbinder                   |       |
| ⑥ |  | Plastikabdeckung für M6 Schrauben |       |

## Piano body assembly

1. Using 12 pcs of TA4\*12 screws to fix 4 pcs of corner connectors of piano brackets to left & right boards separately.
2. Pressing 8 pcs of hammer cuts into the corresponding holes of left & right boards and connection board separately.
3. Using 4 pcs of M6\*50 screws to connect left & right boards with left & right ground feet.
4. Using 4 pcs of M6\*50 screws to connect left & right boards and connection board crossing 4 pcs of plastic cap of M6 screw separately, then cover this cap.
5. Using 4 pcs of M6\*50 screws to connect left & right boards and pedal group parts crossing 4 pcs plastic cap of M6 screws separately, then cover this cap.
6. Put piano body to piano bracket, then, using 4 pcs of M6\*20 screws to fix piano body to piano bracket.
7. Inserting another end of pedal connection line into pedal jack of rear plastic function jack.

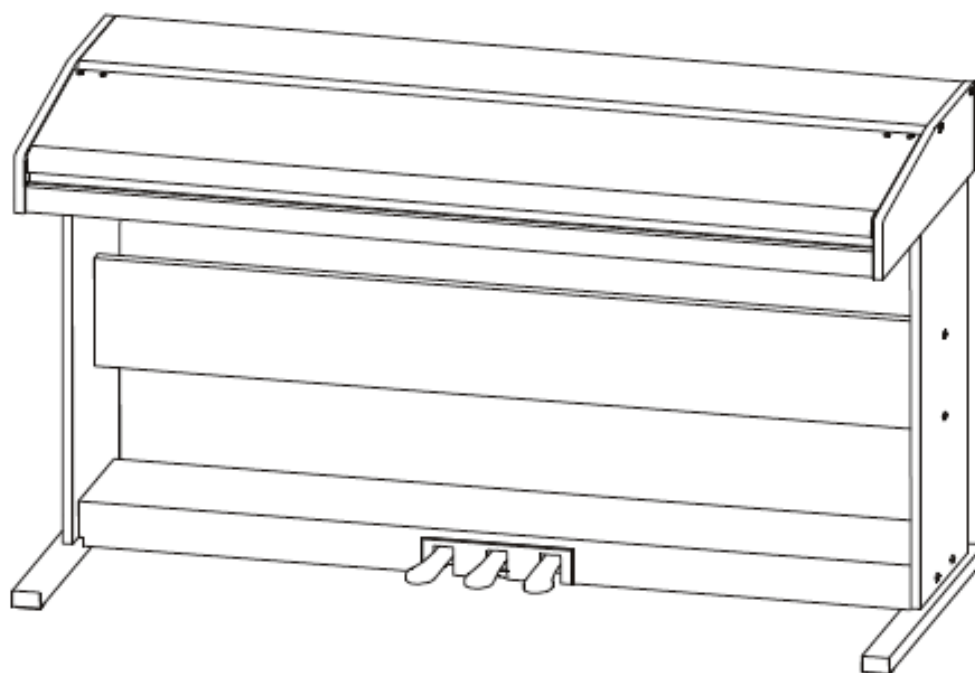

# Assembly diagram

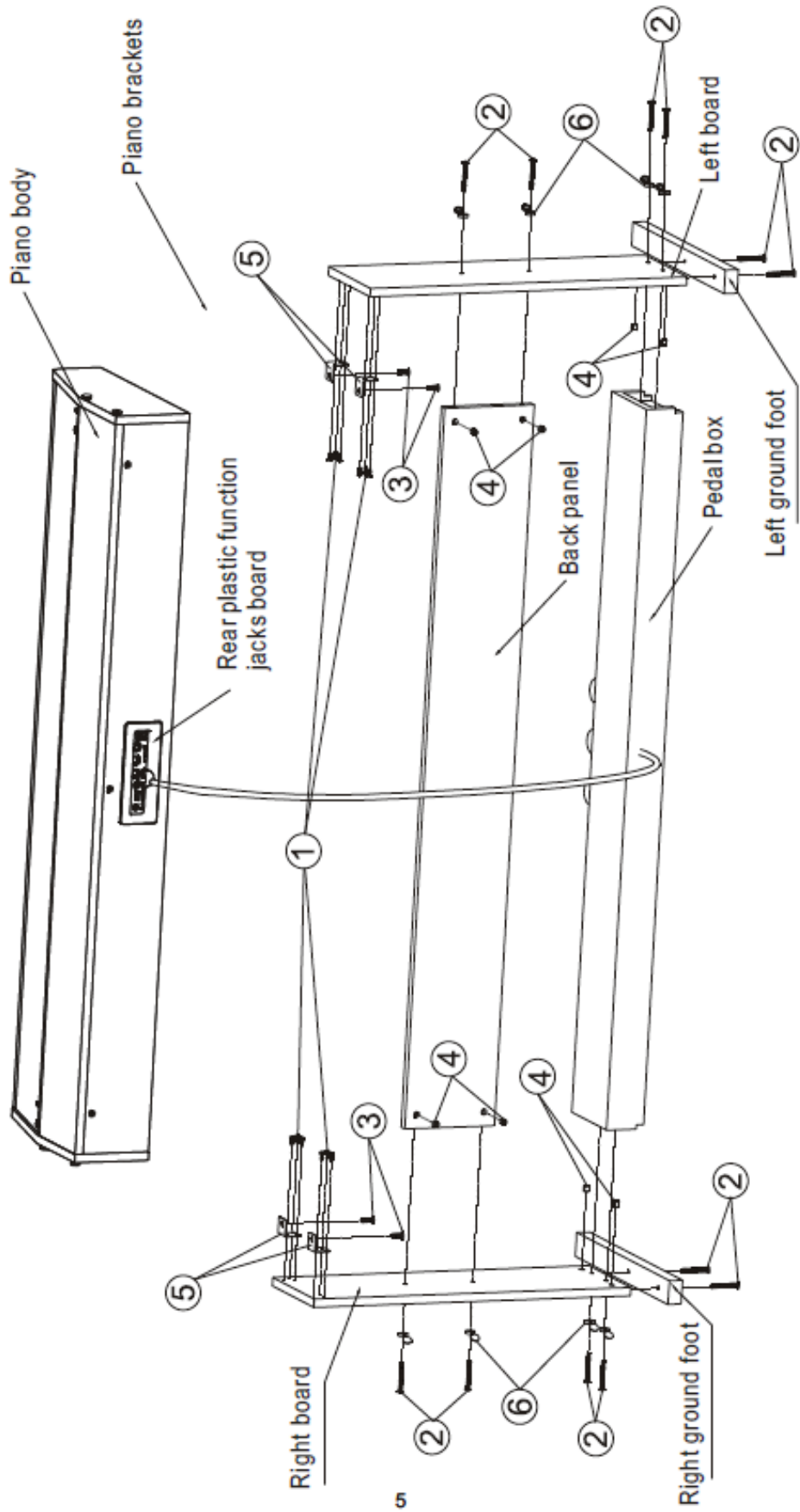

# Preparation before performance

## Power supply

1. Please make sure that this instrument is at off state before connecting power.
2. Connect power adaptor to the DC jack of this instrument.
3. Insert plugs of power adaptor into AC power socket.
4. Pressing down [power] button, LCD screen displays "Loading." Indicating that this piano has been opened.

Notice:

For safety purpose, please cut off the power of this instrument when you don't use it or suffer thunderstorm weather.



## Connect headphone

You can insert stereo headphone into phone jack of this piano when you need exercise alone or play it late at night. The speakers of this instrument will cut off automatically after headphone was entered into phone jack, the sound can only be heard from headphone, You can play as much as you can, you aren't afraid to disturb others.

Notice:

Please avoid using headphone for long time high volume, or else, it will cause human ear fatigue, moreover, hearing damage.

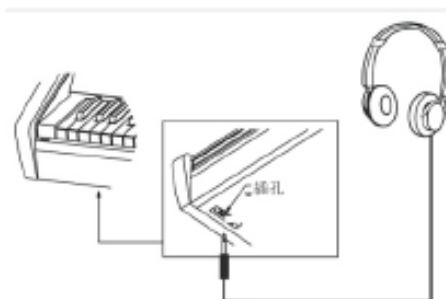

## Connect audio equipment

Connecting this piano with external acoustics equipments, better music effect can be got. The audio out jack in rear panel can be used to connect to keyboard volume amplifier, Stereo acoustics systems, Sound console, Recorder or other equipments Using audio line to connect audio equipment to audio out jack of rear panel, Connecting another end to audio input jack of other equipments.

Notice:

Before connecting other equipments, please make sure that the power of all equipments had been closed, moreover, please make sure that volume setting of every parts had been adjusted to lowest value before opening power of equipments at the same time.

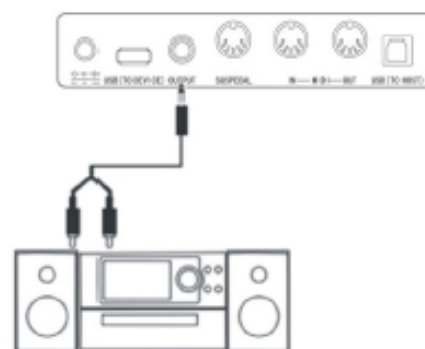

## Connect computer

This piano supplies one USB jack, it can be connected to personal computer. You only need one USB line, one end was inserted into USB jack of this piano, other end was inserted into USB port of computer, it can transfer information with computer in both direction. Such as you can store the music that you had played on this piano to the computer, you also can play MIDI document of your computer by this piano as well.

Notice:

The USB audio equipment can't be setted for input and output at the same time when you do the setting of the computer software, or else the sound will be overlapping when you play the keys.



## Connect to other equipments

Connecting MIDI IN of this instrument to MIDI OUT of other equipments, you can use this instrument as sound source.

Connecting MIDI OUT of this instrument to MIDI IN of other equipments, you can use this instrument as MIDI controller.

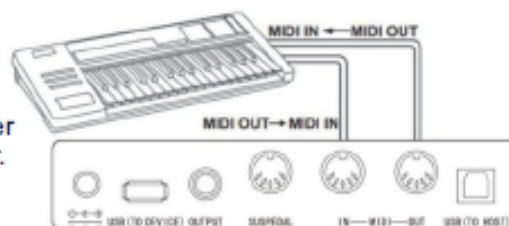

## Connect Pedal

Three pedals group parts was connected to SUSPEDAL jack of rear panel of piano, then, this piano can own three different function pedal: Soft Pedal, Sostenuto Pedal, Sustain Pedal

### 1. Soft Pedal:

The soft pedal was stepped on, the played notes will occur pianissimo effect.

### 2. Sostenuto Pedal:

After this Sostenuto Pedal was stepped on, the playing notes will occur sustain effect before this pedal was stepped on.

### 3. Sustain Pedal:

The sustain pedal was stepped on, the played notes will occur sustain effect.

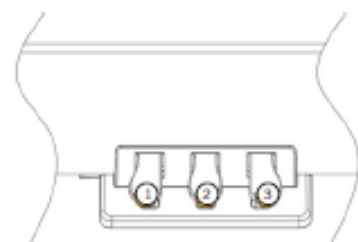

1. Soft Pedal 2. Sostenuto Pedal 3. Sustain Pedal

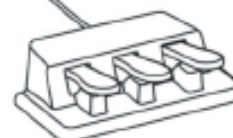

## Connect USB equipment

The piano support to connect largest 32G USB equipment, such as U plate etc, The MP3 files in USB equipment can be played.

Notice:

Don't not pull out USB equipment in playing process, or else it will cause mistake or USB equipment damage.

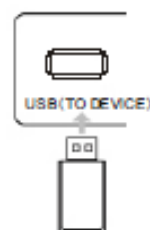



## Power Switch

1. Firstly, Please make sure that the power had been connected correctly.

2. Press down **【Power】** button, LCD display screen will become lighter, Displaying boot screen, indicating that the piano had been opened.

Notice:

The LCD screen hasn't been lighted if you had press down **【Power】** button, please check that whether the power was connected correctly.



## Adjust volume

To rotate **【Master Volume】** knob to the right after the piano was opened, the overall volume will become larger from smaller, to rotate **【Master Volume】** knob to the left, the overall volume will become smaller from larger. You can adjust the volume based on your requirement.



## Play various kinds of instruments voice

This piano has built-in hundreds kinds of vivid voice, including the timbre of chinese folk music, percussion tone etc.

The detailed information, please see voice list. We also supply the effect function that it is relative to voice for your better playing voice

## Choose and play voice(Master voice)

1. Pressing **【Tone】** button, The voice selection mode can be entered into, the reminding mark "R1" lights in LCD at the same time, moreover, the present voice name and no. display as well.

2. Using number button and **【+】/【-】** button to choose the voice that you need.

3. To play keys to start play and appreciate wonderful voice.

Notice:

To change voice selection sourcing you can press **【Voice】** button again and again if you had opened dual voice function. The corresponding R1/R2/L cursor will switch to light to display in LCD display screen.



## Play two kinds of voice (Dual voice)

This piano has dual voice function, The casual two kinds of voice can be superposed and sounded at the same time by this function, The new voice effect will occur to enrich the layers of music. it seems that two kinds of instruments play at the same time. The voice will be first "R1" voice before the dual voice function was started, The choosed voice will be second "R2" after dual voice function had been started.

1. Pressing **【Dual voice】** button to open dual voice function, The "R2" mark lights in LCD, the present dual voice name and No. Display as well at the same time.

2. To choose the dual voice that you want to play by number buttons and **【+】/【-】** buttons.

3. The voice effect that was superposed by two kinds of different voices can be heard when you play the keyboard, it seems that two kinds of instruments are playing at the same time.

4. Press **【Dual voice】** button again, the dual voice effect can be closed, "R2" cursor goes out in LCD, LCD display screen recovers previous state.

Notice:

1. When the music range of keyboard was divided, Only the keyboard in right hand area has dual voice function, the keyboard in left hand area doesn't have this function



## Touch Response

The keyboard of this piano has touch response function, It can help to enrich performance expression. It can reflect the touch that you had used to every notes correctly, It seems that you are playing real instrument. This piano has three pcs touch curves for choosing.

1. Press **【Touch】** button to enter into touch function choosing state. The touch curve no. of present keyboard displays in LCD screen temporarily, The default touch curve is second one in Boot-Up State, there are three pcs touch curves in total (001-003).

2. Choose touch curve

In the state of touch curve that displays in LCD screen temporarily, you can choose different touch curves by press **【Touch】** button continuously.

3. Close touch response

The present touch displays "OFF" in LCD, The relative "Touch" state mark goes out in LCD, it indicates that present keyboard is without touch response state.



## Transpose

To use transpose function, you don't need to change play way, you can adjust the pitch of full keyboard in the unit of semitone.

1. Press down **【Transpose v】** or **【Transpose ^】** button to enter into transpose setting state, The present transpose value "xxx Transpos" displays in LCD temporarily.

2. Adjust tranpose value

When tranpose value "xxx Transpos" displays in LCD screen temporarily, you can press **【Transpose ^/v】** button continuously to adjust keyboard pitch, the largest adjusting scope is  $\pm 12$  pcs semitone.

3. The transpose value will recover to default "000 Transpos" if you press down **【Transpose ^/v】** button at the same time.

Reminder:

If you want to play one G tone music, but you aren't familiar with G tone keyboard, you can set transpose parameter for -05 or 007 at this time, you can use C tone pitch to play to produce G tone real pitch at this time, This parameter adjustment is valid for full keyboard and auto chord accompaniment.



## Piano performance mode

This piano designs this function specially, you can tune out piano tone of full keyboard promptly in other state.

1. Pressing **【Piano】** button, the piano performance mode can be entered into or exited directly.

2. Choosing and starting style in piano performance mode, The accompaniment control can be operated same other mode, but style only play percussion music part, there is no harmony accompaniment part.

Notice:

1. The sound console function and function menu can be entered into in piano performance mode.

2. The chord function will be closed automatically after the piano performance mode was entered into.



## Metronome

If you are afraid that you are't sure about beat when you are practicing music or recording,you can get special metronome reminder by metronome function.

### 1.Open Metronome

Pressing **【Metronome】** button to open metronome function, beat sounds,Pressing **【Metronome】** button again to close metronome function.

### 2.Metronome style setting

Please jump to beat type setting in funtion menu to see setting method.

Notice:

- 1.If the metronome was opened in style playing process,the beat sound will be responded to at the beginning of next beat, the beat point will change followed styles.
- 2.If the metronome was opened fistly,then,play style,this piano will adjust metronome automatically at the same time that the first beat of style sounded to make it match with styles.
- 3.The metronome can be opened in recording,but the sound of metronome wasn't stored as recorded data.



METRONOME



## Playing various kinds of style accompaniments

Using auto accompaniment function,you play piano alone and you can enjoy the accompaniment effect of whole band,moreover, the Orchestra,you only need to start the different styles of accompaniment that you had choosed and use left hand to play suitable chord,the music will go ahead all the time.

This instrument has built in various kinds of auto accompaniment (The detailed information,please see style appendix list),you can choose your favorite accompaniment style and enjoy the pleasure that accompaniments bring to you as much as you can.

## Play auto accompaniment

### (Only play percussion music voice part)

1.Pressing **【Style】**button to enter into style mode, The top-left "STYLE"reminder marking lights in LCD and displays present style name and seria no.at the same time.

### 2.Choose style

You can choose the styles you need by number buttons or **【+】/【-】**buttons.

### 3.Start style

The percussion music part of style can be played immediatly by pressing **【Start/Stop】**button,you also can press**【Sync】**button to make the style to be in sync state.The beat point shines in LCD at the same time, then,play any keys to start style perucussion music performance.



STYLE



## Accompaniment Paragraphs

The auto accompaniment itself of this piano contains many kinds of different accompaniment paragraphs,it is convenient that you arrange your own accompaniments in various kinds of ways.These paragraphs including:Main play(A , B). FILL IN(1 , 2). Intro. Ending.When you play accompaniment,you can make more professional performance effect easily by simple switch of these paragraphs.

### 1. Intro part

Intro is suitable for the beginning of one music, when the intro was played over, the accompaniment will enter into preset main play part. The length of intro will be different based on the difference of choosed style type.

### 2. Main play part

Main play is suitable to the main part of one song, the main play will loop play all the time before you had pressed other style control button.

### 3. FILL IN PART

It can produce various kinds of rich change for songs by FILLING IN paragraph 1 or 2, It enables your performance to be more professional. The accompaniment will switch to relative main play part automatically when FILL IN paragraphes had been played over.

### 4. Ending sound part

Ending sound is suitable to the ending of one song, The song will stop immediately when the ending sound was played over, the length of ending is relative to choosed styles.

Notice:

1. Holding one of **[FILL IN1]**、**[FILL IN2]** button when the accompaniment are going on, the variation will be loop filled in ,untill releasing this button to enter into relative main play part.

2. Pressing FILL IN button will change initial default main play paragraph in the state that the accompaniment has stopped, LCD display screen will display relative marking.

## Play different accompaniment paragraphes

1. Pressing **[STYLE]** button, the styles can be choosed by pressing **[+]**/**[-]** button, numbers buttons at this time.

2. Pressing **[AUTO CHORD]** button to enter into auto bass chord mode.

3. Pressing **[SYNC]** button to open sync start function.

4. Pressing **[FILL IN 1]** to choose main play 1.

5. Pressing **[INTRO/ENDING]** button, FILL IN -"NOR" marking continue to shine in LCD, the style is in play preparation state at this time.

6. The auto accompaniment will start immediately when you pressed one chord in left hand area of keyboard.

The accompaniment will switch to relative main play part when intro part was played over.

7. Pressing **[FILL IN 2]** button, one small paragraph of variation will be filled in the accompaniment that are playing at this time. The accompaniment will switch to relative main play 2 automatically when the variation was played over.

8. Pressing **[INTRO/ENDING]** button, the accompaniment will enter into ending part at this time, the auto accompaniment will be stopped when the ending was played over.



STYLE



## Accompaniment volume control

The accompaniment volume is used for adjusting the overall volume of auto accompaniment. This function can get balance between auto accompaniment part and the volume of keyboard tone.

1. Pressing **[ACCOMPANIMENT VOLUME∇]**/**[ACCOMPANIMENT VOLUME∧]** button, LCD display screen will displays present accompaniment volume size temporarily, the accompaniment volume size can be adjusted by pressing **[ACCOMPANIMENT VOLUME∇]**/**[ACCOMPANIMENT VOLUME∧]** again at this time. Adjustment range: 0~127

2. Pressing **[ACCOMPANIMENT VOLUME∇]** and **[ACCOMPANIMENT VOLUME∧]** buttons at the same time, the accompaniment volume can be closed. LCD display screen displays "Accompaniment volume : OFF". The accompaniment volume can be opened by pressing **[ACCOMPANIMENT VOLUME∇]** and **[ACCOMPANIMENT VOLUME∧]** buttons again at the same time.



## Tempo

Every style has different best tempo value, you can change tempo value based on your hobby and songs requirement.

1. The initial default tempo value can be changed by **[Tempo v]** / **[Tempo ^]** button.
2. The tempo can recover initial default value by pressing **[Tempo v]** / **[Tempo ^]** buttons at the same time.

Notice:

The tempo will be setted for the preset value of present style automatically if you choose style when the styles stopped, The tempo will keep same if you switch style when the style are playing.



## Auto chord

Pressing **[Auto Chord]** button to start auto accompaniment, The left hand will be automatic chord area at this time

## Full rang chord

Pressing **[FULL RANGE CHORD]** button, all keyboard can be played chord sound at this time



## Chord close

Pressing **[CHORD CLOSE]** button, the chord accompaniment sound stops, the style continue to play.

## Chord list

| Original name                | Abbr.             | Normal pronunciation    |
|------------------------------|-------------------|-------------------------|
| MAJOR                        | M                 | 1-3-5                   |
| MAJOR SIXTH                  | M6                | 1-3-5-6                 |
| MAJOR SEVENTH                | M7                | 1-3-(5)-7               |
| MAJOR SEVENTH SHARP ELEVENTH | M7#11             | 1-(2)3#4-(5)-7          |
| MAJOR ADD NINTH              | Madd9             | 1-2-3-5                 |
| MAJOR NINTH                  | M9                | 1-2-3-(5)-7             |
| MAJOR SIXTH ADD NINTH        | 69                | 1-2-3-(5)-6             |
| AUGMENTED                    | aug               | 1-3-#5                  |
| MINOR                        | m                 | 1 <sup>b</sup> 3-5      |
| MINOR SIXTH                  | m6                | 1 <sup>b</sup> 3-5-6    |
| MINOR SEVENTH                | m7                | 1- <sup>b</sup> 3-(5)-7 |
| MINOR SEVENTH FLATTED FIFTH  | m7 <sup>b</sup> 5 | 1-3-5-7                 |
| MINOR ADD NINTH              | madd9             | 1-2-3-5                 |
| MINOR ADD NINTH              | m9                | 1-2-3-5                 |
| MINOR MAJOR ELEVENTH         | m11               | 1-3-(5)-7               |
| MINOR MAJOR SEVENTH          | mM7               | 1- <sup>b</sup> 3-(5)-7 |
| MINOR MAJOR NINTH            | mM9               | 1-2-3-(5)-7             |
| DIMINISHED                   | dim               | 1-3-5                   |
| DIMINISHED SEVENTH           | dim7              | 1-3-5-6                 |
| SEVENTH                      | 7                 | 1-3(5)-7                |
| SEVENTH SUSLEND FOURTH       | 7sus4             | 1-4-5-7                 |
| SEVENTH NINTH                | 79                | 1-2-3-(5)-7             |
| SEVENTH SHARP ELEVENTH       | 7#11              | 1-(2)3-#4-(5)-b7        |
| SEVENTH THIRTEENTH           | 713               | 1-3-(5)-7 / 2-3-5-6-7   |

## Chord list

| Original name              | Abbr.             | Normal pronunciation        |
|----------------------------|-------------------|-----------------------------|
| SEVENTH FLATTED NINTH      | 7 <sup>b</sup> 9  | 1-2-3-(5)-7                 |
| SEVENTH FLATTED THIRTEENTH | 7 <sup>b</sup> 13 | 1-3-5-6-7                   |
| SEVENTH SHARP NINTH        | 7 <sup>#</sup> 9  | (1)- <sup>#</sup> 2-3-(5)-7 |
| MAJOR SEVENTH AUGMENTED    | M7 <sup>aug</sup> | 1-3 <sup>#</sup> -5-7       |
| SEVENTH AUGMENTED          | 7 <sup>aug</sup>  | (1)-3- <sup>#</sup> 5-7     |
| SUSPENED FOURTH            | sus4              | 1-4-5                       |
| ONE PLUS TWO PLUS FIVE     | 1+2+5             | 1-2-5                       |

## Reverb

Pressing **【REVERB】** button, the reverb effect can be opened or closed.

The reverb effect was opened, the reverb cursor will light.  
The reverb effect was closed, the reverb cursor will go out.



REVERB



REVERB

## Chorus

Pressing **【CHORUS】** button, the chorus effect can be opened or closed.

The chorus effect was opened, the chorus cursor will light.  
The chorus effect was closed, the chorus cursor will go out.



CHORUS



CHORUS

## Sound console

The played volume of every tracks can be controlled solely by sound console function.

1. Pressing **【SOUND CONSOLE】** button to enter into sound console function menu, LCD will display corresponding value temporarily. The first time to enter into the sound console menu when the power is on, The first option is "Percussion music track volume" of sound console menu, The option that was entered into again later is same as the option that exited from last time.
2. Pressing **【SOUND CONSOLE】** button again and again to choose the track item that you want to do the setting, then, pressing **【-】 / 【+】** buttons to set parameters.

**Concrete function items and parameters range are as following list:**

| Adjustment content            | LCD display | Adjustment range |
|-------------------------------|-------------|------------------|
| Percussion music track volume | XXX Rhythm  | 0 - 127          |
| Bass track volume             | XXX Bass    | 0 - 127          |
| Hamony track volume           | XXX Chord   | 0 - 127          |
| Phrase track volume           | XXX Phrase  | 0 - 127          |
| left hand track volume        | XXX Lower   | 0 - 127          |
| Right hand track volume       | XXX Upper   | 0 - 127          |

Notice:

If there is no any setting operation in 5 seconds in sound console setting state, the sound console function state will exit automatically.



SOUND CONSOLE

## Function menu

Pressing【FUNCTION MENU】button to enter into function menu, LCD displays present function menu option temporarily, to set the parameters of present menu by pressing 【-】 / 【+】 buttons.



FUNCTION MENU

Concrete function items and parameters range are as following list:

| Serial no. | Adjustment content | LCD Display  | Adjustment range | Presetting value |
|------------|--------------------|--------------|------------------|------------------|
| 1          | Tune               | XXX Tune     | -50 ~ +50        | 000              |
| 2          | Keyboard split     | XXX KeySplit | 1 ~ 88           | 034              |
| 3          | Beat type          | XXX BeatType | 0, 2 ~ 9         | 004              |
| 4          | Metronome volume   | XXX MetroVol | 0~127            | 080              |
| 5          | Reverb depth       | XXX Revb Lev | 0~127            | 050              |
| 6          | Chorus depth       | XXX Chor Lev | 0~127            | 000              |
| 7          | MIDI Receiving     | XXX Midi In  | 1 ~ 16, ALL      | ALL              |
| 8          | MIDI Sending       | XXX Midi Out | 1 ~ 16           | 001              |

Notice:

If there is no any setting operation in 5 seconds in function menu setting state, the function menu state will exit automatically.

## Tune setting

This function is used to adjust pitch detailedly.

1. Pressing 【FUNCTION MENU】button to select tune menu, LCD displays "xxx Tune" temporarily, You can press 【+】/【-】buttons to adjust pitch, the largest adjustment range is  $\pm 50$ , it is to rise or reduce one half-tone.

2. Pressing 【+】 and 【-】 buttons at the same time, the pitch will recover to presetting value: 000. This parameter adjustment is valid for keyboard and styles.

## Keyboard split setting

The position to split auto bass chord area and right hand area in keyboard is called "KEYBOARD SPLIT POINT". The keyboard in left hand area are used for controlling auto bass chord accompaniment generally when auto bass chord function was opened, the keyboard in left hand area also can be used for playing voice.



SPLIT

1. Pressing【FUNCTION MENU】button to choose keyboard split point setting menu, LCD displays "xxx KeySplit" temporarily, You can press 【-】/【+】buttons to set keyboard split point at this time, you also can play keys directly to do prompt setting.

The adjustment range: 1~88.

2. Pressing 【-】 and 【+】 buttons at the same time, the keyboard split point will recover to presetting value: F#3 ( 34 )

## Beat type setting

1. Pressing **[FUNCTION MENU]** button to choose beat type menu, LCD displays "xxx BeatType" temporarily, You can press **[-]/[+]** button to choose beat type at this time, this function supplies 0, 2~9 (total 9 kinds of beats) for your selection.

2. Pressing **[-]** and **[+]** buttons at the same time, beat type will recover to presetting value: 004.

000 BeatType

## Metronome volume setting

1. Pressing **[FUNCTION MENU+]** or **[FUNCTION MENU-]** button to choose metronome volume setting menu, LCD displays "xxx MetroVol" temporarily, You can press **[+]/[-]** button to set metronome volume at this time, range: 0~127.

2. Pressing **[+]** and **[-]** buttons at the same time, metronome volume will recover to presetting value: 080.

000 MetroVol

## Reverb depth setting

1. Pressing **[FUNCTION MENU]** button to choose reverb depth setting menu, LCD displays "xxx ReverbLev" temporarily, You can press **[-]/[+]** button to set reverb depth at this time. Range: 0~127.

2. Pressing **[-]/[+]** buttons at the same time, reverb depth will recover to presetting value: 050.

000 ReverbLev

## Chorus depth setting

1. Pressing **[FUNCTION MENU]** button to choose chorus depth setting menu, LCD displays "xxx ChorusLev" temporarily. You can press **[-]/[+]** button to set chorus depth at this time. Range: 0~127.

2. Pressing **[-]** and **[+]** buttons at the same time, Chorus depth will recover to presetting value: 000.

000 ChorusLev

## MIDI receiving setting

1. Pressing **[FUNCTION MENU]** button to choose MIDI receiving channel setting menu, LCD displays "xxx Midi In" temporarily, You can press **[-]/[+]** button to set MIDI receiving channels at this time. Setting range: 1~16, ALL.

2. Pressing **[-]** and **[+]** buttons at the same time, MIDI channel will recover to presetting value: ALL.

000 Midi In

## MIDI Sending setting

1. Pressing **[FUNCTION MENU]** button to choose MIDI sending channel setting menu, LCD displays "xxx Midi Out" temporarily. You can press **[-]/[+]** button to set MIDI sending channels at this time. Range: 1~16

2. Pressing **[-]** and **[+]** buttons at the same time, MIDI channel will recover to presetting value: 001.

000 Midi Out



## Factory reset

Pressing **[-]** and **[+]** buttons when power is off, then, open the power, the system will recover to factory reset, and delete all users' data in this piano, including: Users' songs, users' registration memory. The LCD will display "Wait..!". The system will be entered into automatically after deletion was finished, then recover to normal open state.

## Panel registration memory setting

This instrument has panel registration memory function, it can be used for saving your most favorite setting as to the setting can be tuned out easily and promptly when you need it, moreover, it can enable your performance to be more efficient. Panel registration memory function can almost store all setting of panel, you only need to press one button simply, the setting can be tuned out immediately.

## Save setting to storage

1. This instrument has 4 pcs registration memory banks, every registration bank includes 2 groups storage memory state (M1~M2) .

2. When you press **[STORE]** button, press one of **[M1]** - **[M2]** button at the same time, present panel can be setted to registration memory. Please notice: This operation will cover previous stored registration memory.

Notice:

Holding **[STORE]** and **[M1]** buttons at the same time, open the power again, all registration memory will all recover to factory reset state at this time.



## Tune out registration memory

Pressing one of **[M1]** - **[M2]** button to tune out one group setting to replace present state.

## Choose memory bank

1. Pressing **[BANK]** button, LCD displays memory bank serial no. temporarily.

2. Pressing **[BANK]** button again and again at this time, you can choose to set memory bank. Range: 1~2

3. The following content can be stored in M1-M2 storage memory state:

Voice parameters: Main voice, Dual voice, Keyboard split point voice, Digital effect, Sound console.

Accompaniment parameters: Style, tempo, Auto bass chord open/close, paragraphs selection.

Function parameters: Touch, partial parameters in function menu.

【START/STOP】button again,the present song will loop play.

4.Pressing 【STYLE】、【RECORD】【VOICE】、【DUAL VOICE】etc function buttons,the song mode can be exited when the song has stopped playing.

## Record your own songs

The record function of this piano can record/replay your performance,you can appreciate your own opus by replaying.You can record many pieces of users'songs in this piano ,every song can record 3pcs tracks at most,it is 1pc accompaniment track and 2pcs melody tracks.

The accompaniment track was used for recording style,it is songs'accompaniment,The melody track was used for recording playing melody.The accompaniment track and melody track can record at the same time,but,it cann't record 2pcs melody tracks at the same time,of course,you also can only record melody or accompaniment separately;The accompaniment track and melody track can replay at the same time.

The users'song has storage function if there is power-fail,the data cann't loss when the power is off.

## Start record

You need to choose one pc user's song that will be used for storing record before the record was starting and set record tracks.

1.Pressing【RECORD】button to enter into users'songs selection interface.The left top of LCD displays serial no. of users'songs,The characters display area displays users' songs name,The default name is "RecSong1".You can choose users'songs that need to store record by 【-】/【+】buttons.

2.Pressing 【RECORD】button to enter into record preparation state,"REC" marking lights in bottom part of LCD,4pcs beat points shine at the same time in beat display area. This piano will choose one melody track that has no data to store your record automatically,The track cursor shines in LCD ,it refers to the present track that stored record.

3.You can choose voice、 style , adjustment tempo etc.that you want to record in record preparation state.You can press 【TRACK1】、【TRACK2】~【TRACK3】button to choose the tracks that you want to record,it means that the track was choosed when cursor shines. The accompaniment track and melody track can record at the same time,but cann't record 2pcs melody tracks at the same time.

4.To press【START/STOP】button or play piano's keys directly to start record after the record tracks were choosed.When the record accompaniment was choosed and the auto bass chord accompaniment function was opened,to play one effective chord in keyboard left hand area,the record can be started as well.

### Notice:

The style data can only be recorded in accompaniment track.

The record track cursor has three kinds of state:Shine,Light,Go out.

Shining,it means that this track has been choosed for record,if this track has already have data, the original data will be covered if you continue to record in this track.Lighting,it means that this track has data,It wil replay recorded data synchronously in record process.Going out,it means that this track has no data or has data,but has been prohibited to replay when the record was going on.The tracks state can be switched by pressing【TRACK1】~【TRACK3】again and again in record preparation state.

This piano will choose one empty melody track to store record automatically (the system will choose automatically in the order of small to large.such as:if track2 has data,then,the system will choose track3 to store this time record)in record preparation state,if two tracks had already have data,then,it will choose track2 to store record.

Track1 : Accompaniment track

Track2/Track3: Melody track



001 RecSong1

001 StGrdPno

notes are correct or wrong, the chords or left hand melody part can sound.

Pressing **[Left]** & **[Right]** buttons at the same time, the left hand and right hand can be learned at the same time, The system will make estimation after the learning was over.

## Stop record

1. Pressing **[Start/Stop]** button can stop record immediately in record process, Pressing **[Style]** or **[Voice]** selection button can enter into other function.

2. If the internal memory is full, the record will stop and store automatically in record process, "Rec\_Full" will display in LCD temporarily to remind that the internal memory has been recorded full.

3. The record will stop automatically after the style had played ending over if you had chosen record accompaniment.



## Replay recorded songs

1. The record will stop and enter into songs state automatically and loop play previous recorded users' songs immediately if **[RECORD]** button was pressed in record process.

2. Pressing **[SONG]** button to enter into song state in standby mode, all songs will loop play automatically. The serial no. of users' songs can be selected directly by pressing **[-]/[+]** buttons, such as: If there is no recorded data in one user's songs, "NoFile!" will display in LCD display screen, reminding that there is no recorded data in present files, moreover, the loop play will stop.

3. Choosing one user's song that has data in the state that songs has stopped, Pressing **[START/STOP]** button to start loop play this song.



## Delete recorded songs

1. Pressing **[RECORD]** and **[SONG]** at the same time when the power is off, then, open the power, all users' songs will be cleared.

2. Pressing **[RECORD]** button for 2 seconds to enter into tracking deleting state in record preparation state, The LCD displays "Delete?". Pressing **[TRACK1]**、**[TRACK2]**、**[TRACK3]** to choose the track you want to delete in deleting state, when the cursor of one certain track lights, it indicates that the data of this track will be deleted, when the cursor of track goes out, it indicates that the data of this track will be kept. If the cursors of all tracks light, the data of complete song will be deleted when the deleting operation was carried out.

3. Pressing **[+]** button to carry out deleting operation after the tracks that you want to delete was choosed, it will return to record preparation state automatically after the operation was finished, Pressing **[-]** button to cancel deleting operation and return to record preparation state.



## Play and control songs

This instrument has presetting many kinds of different types songs. Every song has learning function. (For detailed information, please see songs list)

## Appreciate songs

1. Pressing **[SONG]** button to enter into song mode, LCD lights "SONG" marking, All songs will begin with loop play now.

2. You can choose the songs that you want to appreciate by numbers button or **[-]/[+]** buttons.

3. To press **[START/STOP]** button to stop playing in the state that songs are playing, but doesn't exit song state, pressing



## Song control

### 1.Guiding beat function

The song will have guiding beat instructions before intro was played formally.

### 2.Fast forward, Fast backward, Play/Pause and stop functions of songs.

Pressing down [▶▶] button can speed up to play songs when songs are playing,pressing down [◀◀] button can return back songs,pressing down [▶/■] button can pause to play songs, pressing down [▶/■] button again to continue to play songs, pressing down [■] button can stop playing present songs.

### 3.The fragment loop function of song

Pressing down [↺] button can set starting point and ending point of loop play when the song are playing,pressing this button first time to set loop starting point,pressing this button second time to set loop ending point,when ending point was finished setting,the song will loop play the content between the two points.

Pressing down [↻] button can exit loop and continue to play songs in the state of fragment loop.

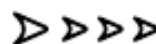

## Song learning mode

The learning function of song are consist of [Lesson]、[Left]、[Right]these three buttons,these three buttons are valid only in song mode.All songs can be learned by three mode:Durationlearning,Pitch learning and play mode. This piano can give score based on your learning situation when the learning was over,it helps you to make progress continuously in learning process.

### 1.Enter into song learning mode

Pressing [Lesson]button to enter into song learning mode in the state of the song had been stopped play.

### 2.Choose left hand or right hand to learn songs

The songs of this instrument can be choosed for three different kinds of way to learn.You can choose the learning part you need by [Left]or [Right]buttons,if you haven't proceed with selection,the system will choose right hand learning for you automatically.

#### Notice:

The content of left hand learning will aslo be different based on different songs type.For style type songs,the left hand will be used for learning chords;For piano songs,the left hand will be used for learning part melody of left hand.The MIDI type songs doesn't support left hand learning function.The staff and chord display area in LCD will display melody or chords of songs when the songs are playing,It is convenient for following learning.



## learning mode1: Duration learning

1.Pressing [Lesson]button to enter into learning mode1 in the state that the songs were stopped playing."Les1 R"will displays in LCD temporarily.The system will estimate the played duration of learner,it doesn't estimate the correctness of notes and chords in learning mode1,the song plays normally.

2.Pressing [Start/Stop]button to begin with songs learning.

If you choose right hand to learn songs,the melody part of right hand will be concealed.The learner only needs to play correct duration,the melody will sound in the process of song playing, it is no need to consider that the played notes are correct or wong.

If you choose left hand to learn songs,the chords of songs or left hand melody part will be concealed,the learner only need to play correct duration,it is no need to consider that the played

## Learning mode2: Pitch learning

1. Pressing **[Learn]** button repeatedly to enter into learning mode2 in the state that song has been stopped play. "Les2 R" reminder marking lights in LCD . The system only estimates the correctness of pitch of notes that learner has played, The song can go ahead backwards when it needs learner to play correct notes. If the pitch of played notes is wrong, the song will be in waiting state until the correct notes was played.
2. Pressing **[Start/Stop]** button to begin to learn song, it will give estimation after the learning was over.

Les2 R

## Learning mode3: Play mode

1. Pressing **[Learn]** button repeatedly to enter into learning mode3 in the state that song has been stopped play. "Les3 R" reminder marking lights in LCD . The system only estimate the correctness of duration and pitch that learner are playing comprehensively. The song plays normally, learner must play correct pitch based on origin alduration of song, then, it can be estimated correct by system
2. Pressing **[Start/Stop]** button to begin to learn song, it wil give estimation after the learning was over.

Les3 R

## MP3 Play

MP3 Jack:MP3 song can play by this jack  
Pressing **[Play/Pause]** button can switch present state of songs  
Pressing **[Song ^]** button ,one song goes backward,pressing **[Volume v]** button for longer time, the volume will reduce small.  
Pressing **[Song v]** button ,one song goes forward,pressing **[Volume ^]** button for longer time, the volume will increase large.

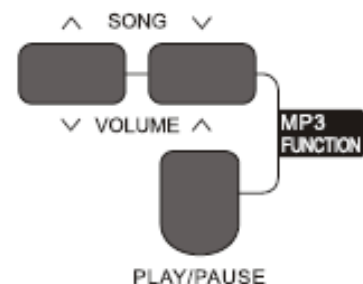

## Voice List

(See attachment list)

## Style List

(See attachment list)

## Song list

(See attachment list)

## Voice List

| Classify             | No. | Full english Name                 | English Abbr |
|----------------------|-----|-----------------------------------|--------------|
| Piano                | 1   | Stereo Grand Piano                | StGrdPno     |
| Piano                | 2   | Acoustic Grand Piano (wide) 1     | GrandPnW     |
| Piano                | 3   | Acoustic Grand Piano (dark)       | GrandPnD     |
| Piano                | 4   | Octave Piano 1                    | OctPno1      |
| Piano                | 5   | Octave Piano 2                    | OctPno2      |
| Piano                | 6   | Piano & Strings                   | Pno&Str      |
| Piano                | 7   | Piano & Choir                     | Pno&Cho      |
| Piano                | 8   | Acoustic Grand Piano              | GrandPno     |
| Piano                | 9   | Stereo Bright Piano               | StBrtPno     |
| Piano                | 10  | Bright Acoustic Piano             | BritePno     |
| Piano                | 11  | Bright Acoustic Piano (wide) 1    | BritePnW     |
| Piano                | 12  | Chorus Piano                      | ChoruPno     |
| Piano                | 13  | Electric Grand Piano              | E. Grand     |
| Piano                | 14  | Electric Grand Piano (wide)       | E. GrandW    |
| Piano                | 15  | Stereo Honk-Tonk                  | StHonkTo     |
| Piano                | 16  | Honky-tonk Piano                  | HnkyTonk     |
| Piano                | 17  | Honky-tonk Piano (wide) 1         | HnyTonkW     |
| Piano                | 18  | Stereo Hard Electric Piano        | StHarEp      |
| Piano                | 19  | Detuned Electric Piano 1          | DetunEP1     |
| Piano                | 20  | Detuned Electric Piano 2          | DetunEP2     |
| Piano                | 21  | Electric Piano 1                  | E. Piano 1   |
| Piano                | 22  | Electric Piano 2                  | E. Piano 2   |
| Piano                | 23  | Electric Piano (wide) 1           | EPnoW1       |
| Piano                | 24  | Electric Piano (wide) 2           | EPnoW2       |
| Piano                | 25  | EP Legend                         | EP Legend    |
| Piano                | 26  | EP Phase                          | EP Phase     |
| Piano                | 27  | 60's Electric Piano               | 60'sEP       |
| Piano                | 28  | Electric Piano 1 (velocity mix)   | E. PnoV1     |
| Piano                | 29  | Electric Piano 2 (velocity mix)   | E. PnoV2     |
| Piano                | 30  | Velocity Crossfade Electric Piano | VeCrosEP     |
| Piano                | 31  | Layered Electric Piano 1          | LayerEP1     |
| Piano                | 32  | Layered Electric Piano 2          | LayerEP2     |
| Piano                | 33  | Nylon Electric Piano              | NylonEP      |
| Piano                | 34  | Warm Electric Piano               | WarmEP       |
| Piano                | 35  | Grand Harpsichord                 | GraHarps     |
| Piano                | 36  | Harpsichord 1                     | Harpsi       |
| Piano                | 37  | Harpsichord 2                     | Harpsi2      |
| Piano                | 38  | Harpsichord (wide)                | HarpsiW      |
| Piano                | 39  | Harpsichord (octave mix) 1        | HarpsiO      |
| Piano                | 40  | Harpsichord Release               | HarpsiR      |
| Piano                | 41  | Harpsichord (with key off)        | HarpsiOf     |
| Piano                | 42  | Clavi 1                           | Clavi        |
| Piano                | 43  | Clavi 2                           | Clavi 2      |
| Piano                | 44  | Clavi (wide) 1                    | ClaviW1      |
| Piano                | 45  | Clavi (wide) 2                    | ClaviW2      |
| Piano                | 46  | Clavi Wah                         | ClaviWa      |
| Piano                | 47  | Pulse Clavi                       | PulseClv     |
| Chromatic Percussion | 48  | Celesta 1                         | Celesta      |
| Chromatic Percussion | 49  | Celesta 2                         | Celesta2     |
| Chromatic Percussion | 50  | Birght Celeasta                   | BirCelea     |
| Chromatic Percussion | 51  | Celesta & Sine                    | Celes&Si     |
| Chromatic Percussion | 52  | Reecho Bell                       | ReechBell    |
| Chromatic Percussion | 53  | Celesta & Music Box               | Celes&MB     |
| Chromatic Percussion | 54  | Glockenspiel 1                    | Glocken      |
| Chromatic Percussion | 55  | Glockenspiel 2                    | Glocken2     |
| Chromatic Percussion | 56  | Music Box 1                       | MusicBox     |
| Chromatic Percussion | 57  | Music Box 2                       | MusicBo2     |
| Chromatic Percussion | 58  | Music Box 3                       | MusicBo3     |
| Chromatic Percussion | 59  | Toy Box                           | ToyBox       |
| Chromatic Percussion | 60  | Music Box & Harp                  | Mbx&Harp     |
| Chromatic Percussion | 61  | Stereo Vibrapho                   | StVibes      |
| Chromatic Percussion | 62  | Rigid Vibraphone                  | RigiVibe     |

## Voice List

| Classify             | No. | Full english Name                 | English Abbr |
|----------------------|-----|-----------------------------------|--------------|
| Chromatic Percussion | 63  | Vibraphone 1                      | Vibra        |
| Chromatic Percussion | 64  | Vibraphone 2                      | Vibra2       |
| Chromatic Percussion | 65  | Vibraphone (wide) 1               | VibraW       |
| Chromatic Percussion | 66  | Vibraphone (wide) 2               | VibraW2      |
| Chromatic Percussion | 67  | Vibraphone & Bell                 | Bell&Vib     |
| Chromatic Percussion | 68  | Marimba 1                         | Marimba      |
| Chromatic Percussion | 69  | Marimba 2                         | Marimba2     |
| Chromatic Percussion | 70  | Marimba (wide)                    | MarimbaW     |
| Chromatic Percussion | 71  | Stereo Marimba                    | StMarim      |
| Chromatic Percussion | 72  | Marimba & Vibraphone              | Mar&Vib      |
| Chromatic Percussion | 73  | Xylophone 1                       | Xylophone    |
| Chromatic Percussion | 74  | Xylophone 2                       | Xylopho2     |
| Chromatic Percussion | 75  | Tubular Bells                     | TubuIBell    |
| Chromatic Percussion | 76  | Church Bell                       | Chu rBell    |
| Chromatic Percussion | 77  | Carillon                          | Carillon     |
| Chromatic Percussion | 78  | Dulcimer                          | Dulcimer     |
| Chromatic Percussion | 79  | Santur                            | Santur       |
| Organ                | 80  | Drawbar Organ 1                   | DrawbOrgan   |
| Organ                | 81  | Drawbar Organ 2                   | DrawbOrgan 2 |
| Organ                | 82  | Soft Stereo Drawbar Organ         | SfDrawOrgan  |
| Organ                | 83  | Mellow Drawbar Organ              | MelIDrOr     |
| Organ                | 84  | Detuned Drawbar Organ 1           | DeDraOr      |
| Organ                | 85  | Detuned Drawbar Organ 2           | DeDraOr2     |
| Organ                | 86  | Italian 60's Organ                | 60'sOrgn     |
| Organ                | 87  | 1970 Percussive Organ             | 1970Pc:Or    |
| Organ                | 88  | Percussive Organ 1                | PercOrgn1    |
| Organ                | 89  | Percussive Organ 2                | PercOrg2     |
| Organ                | 90  | Light Click Organ                 | LClickOr     |
| Organ                | 91  | Detuned Percussive Organ          | DePerOrg     |
| Organ                | 92  | Stereo Rotary Organ               | StRotaOr     |
| Organ                | 93  | Rock Organ                        | RockOrgn     |
| Organ                | 94  | Rotary Organ                      | RotaOrgn     |
| Organ                | 95  | Slow Rotary Organ                 | SloRotOr     |
| Organ                | 96  | Detuned Church Organ              | DeChuOrg     |
| Organ                | 97  | Church Organ 1                    | Chu rOrgn    |
| Organ                | 98  | Church Organ 2                    | Chu rOrg2    |
| Organ                | 99  | Church Organ (octave mix)         | Chu rOrgO    |
| Organ                | 100 | Reed Organ                        | ReedOrgn     |
| Organ                | 101 | Puff Organ                        | PuffOrgn     |
| Organ                | 102 | Accordion 1                       | Accordion    |
| Organ                | 103 | Accordion 2                       | Accordin2    |
| Organ                | 104 | Accordion 3                       | Accordin3    |
| Organ                | 105 | Mustte                            | Mustte       |
| Organ                | 106 | Accord It Solo                    | AccordSo     |
| Organ                | 107 | Sweet Harmonica                   | SwethArm     |
| Organ                | 108 | Harmonica 1                       | Harmonica    |
| Organ                | 109 | Harmonica 2                       | Harmonic2    |
| Organ                | 110 | Tango Accordion                   | TangoAcd     |
| Guitar               | 111 | Acoustic Guitar (nylon) 1         | NylonGtr     |
| Guitar               | 112 | Acoustic Guitar (nylon) 2         | NylonGt2     |
| Guitar               | 113 | Acoustic Guitar (nylon + key off) | NyIGtrOf     |
| Guitar               | 114 | Ukulele                           | Uku lele     |
| Guitar               | 115 | Velocity Nylon Guitar             | NyInGtVe     |
| Guitar               | 116 | Chorus Nylon Guitar               | Cho NyGt     |
| Guitar               | 117 | Bright Nylon Guitar               | BrNyGt       |
| Guitar               | 118 | Acoustic Guitar (steel) 1         | SteelGtr     |
| Guitar               | 119 | Acoustic Guitar (steel) 2         | SteelGt2     |
| Guitar               | 120 | Steel Guitar with Body Sound      | SteelBdy     |
| Guitar               | 121 | Tremolo Steel Guitar              | TremGt       |
| Guitar               | 122 | Mandolin                          | Mandolin     |
| Guitar               | 123 | 12-Strings Guitar                 | 12StrGtr     |
| Guitar               | 124 | Chorus Steel Guitar               | ChoStEGt     |

## Voice List

| Classify                         | No. | Full english Name                   | English Abbr |
|----------------------------------|-----|-------------------------------------|--------------|
| Guitar                           | 125 | Nylon & Steel Guitar                | Ny&SteGt     |
| Guitar                           | 126 | Stereo Steel Guitar                 | StSteGt      |
| Guitar                           | 127 | Steel Guitar Bend                   | GtBend       |
| Guitar                           | 128 | Steel Guitar Harmonics              | GtHarm       |
| Guitar                           | 129 | Velocity Steel Guitar 1             | VelSte1      |
| Guitar                           | 130 | Velocity Steel Guitar 2             | VelSte2      |
| Guitar                           | 131 | Velocity Steel Guitar 3             | VelSte3      |
| Guitar                           | 132 | Electric Guitar (jazz) 1            | JazzGtr      |
| Guitar                           | 133 | Electric Guitar (jazz) 2            | JazzGt2      |
| Guitar                           | 134 | Electric Guitar (pedal steel)       | PedalGtr     |
| Guitar                           | 135 | Mellow Guitar                       | MellGt       |
| Guitar                           | 136 | Velocity Jazz Guitar                | JazzGtVe     |
| Guitar                           | 137 | Jazz Guitar Detuned                 | JazzGtDt     |
| Guitar                           | 138 | Mid Tone Guitar                     | MidTonGt     |
| Guitar                           | 139 | Electric Guitar (clean) 1           | CleanGtr     |
| Guitar                           | 140 | Electric Guitar (clean) 2           | CleanGtr2    |
| Guitar                           | 141 | Stereo Clean Guitar                 | StCleGtr     |
| Guitar                           | 142 | Velocity Clean Guitar               | CleGtVel     |
| Guitar                           | 143 | Electric Guitar (detuned clean)     | DetClnGt     |
| Guitar                           | 144 | Electric Guitar (muted velo -sw)    | MutVelGt     |
| Guitar                           | 145 | Electric Guitar (muted)             | MutedGtr     |
| Guitar                           | 146 | Electric Guitar (funky cutting)     | FunkGt       |
| Guitar                           | 147 | Jazz Man                            | JazzMan      |
| Guitar                           | 148 | Stereo Muted Guitar                 | StMuGt       |
| Guitar                           | 149 | Guitar Pinch                        | GtPinch      |
| Guitar                           | 150 | Overdriven Guitar                   | Overdrive    |
| Guitar                           | 151 | Distortion Guitar 1                 | DistGt       |
| Guitar                           | 152 | Distortion Guitar 2                 | DistGtr2     |
| Guitar                           | 153 | Distortion Guitar (with feedback) 1 | FeedbkGt     |
| Guitar                           | 154 | Distorted Rhythm Guitar             | DistRyth     |
| Guitar                           | 155 | 5th Distortion                      | 5thDist      |
| Guitar                           | 156 | Stereo Distorted Guitar             | StDistor     |
| Guitar                           | 157 | Guitar Feedback                     | GtFdbk       |
| Guitar                           | 158 | Guitar Harmonics                    | GtrHarmo     |
| Bass                             | 159 | Acoustic Bass 1                     | AcoBass      |
| Bass                             | 160 | Acoustic Bass 2                     | AcoBass2     |
| Bass                             | 161 | Jazz Style                          | JazzSty      |
| Bass                             | 162 | A. Bass & Mute G.T.                 | Ba&GtMu      |
| Bass                             | 163 | Resonant Bass                       | ResBass      |
| Bass                             | 164 | Wah Bass 1                          | WahBass1     |
| Bass                             | 165 | Electric Bass (finger) 1            | FngrBass     |
| Bass                             | 166 | Electric Bass (finger) 2            | FngrBas2     |
| Bass                             | 167 | Electric Bass (finger) 3            | FngrBas3     |
| Bass                             | 168 | Finger Slap Bass                    | FngrSlap     |
| Bass                             | 169 | Electric Bass (pick) 1              | PickBass     |
| Bass                             | 170 | Electric Bass (pick) 2              | PickBas2     |
| Bass                             | 171 | Fretless Bass 1                     | Fretless     |
| Bass                             | 172 | Fretless Bass 2                     | Fretless2    |
| Bass                             | 173 | Slap Bass 1                         | SlapBass     |
| Bass                             | 174 | Slap Bass 2                         | SlapBass2    |
| Bass                             | 175 | Synth Bass 1                        | SynBass      |
| Bass                             | 176 | Synth Bass 2                        | SynBass2     |
| Bass                             | 177 | Synth Bass 3 (resonance)            | ResoBass     |
| Bass                             | 178 | Synth Bass 4 (attack)               | Atac kBass   |
| Bass                             | 179 | Synth Bass (warm)                   | WarmBass     |
| Bass                             | 180 | Clavi Bass                          | ClavBass     |
| Bass                             | 181 | Hammer                              | Hammer       |
| Bass                             | 182 | Synth Bass (rubber)                 | RubbBass     |
| Bass                             | 183 | Attack Pulse                        | Atac kPls    |
| Strings & Orchestral Instruments | 184 | The Violin                          | TheVin       |
| Strings & Orchestral Instruments | 185 | Violin 1                            | Violin       |



## Voice List

| <b>Classify</b>                  | <b>No.</b> | <b>Full english Name</b>     | <b>English Abbr</b> |
|----------------------------------|------------|------------------------------|---------------------|
| Strings & Orchestral Instruments | 186        | Violin 2                     | Violin2             |
| Strings & Orchestral Instruments | 187        | Violin (slow attack)         | SIViolin            |
| Strings & Orchestral Instruments | 188        | Soft Violin                  | SoftVin             |
| Strings & Orchestral Instruments | 189        | Viola 1                      | Viola               |
| Strings & Orchestral Instruments | 190        | Viola 2                      | Viola2              |
| Strings & Orchestral Instruments | 191        | Cello 1                      | Cello               |
| Strings & Orchestral Instruments | 192        | Cello 2                      | Cello2              |
| Strings & Orchestral Instruments | 193        | Celloen 16'                  | Celloen             |
| Strings & Orchestral Instruments | 194        | Contrabass 1                 | Contrabs            |
| Strings & Orchestral Instruments | 195        | Contrabass 2                 | Contrabs2           |
| Strings & Orchestral Instruments | 196        | Tremolo Strings 1            | TremStr             |
| Strings & Orchestral Instruments | 197        | Tremolo Strings 2            | TremStr2            |
| Strings & Orchestral Instruments | 198        | Pizzicato Strings 1          | PizzStr             |
| Strings & Orchestral Instruments | 199        | Pizzicato Strings 2          | PizzStr2            |
| Strings & Orchestral Instruments | 200        | Orchestral Harp 1            | Harp                |
| Strings & Orchestral Instruments | 201        | Orchestral Harp 2            | Harp2               |
| Strings & Orchestral Instruments | 202        | Timpani 1                    | Timpani             |
| Strings & Orchestral Instruments | 203        | Timpani 2                    | Timpani2            |
| Ensemble                         | 204        | String Ensembles 1           | Strings1            |
| Ensemble                         | 205        | String Ensembles 2           | Strings2            |
| Ensemble                         | 206        | Synth Strings 1              | SynStrs1            |
| Ensemble                         | 207        | Synth Strings 2              | SynStrs2            |
| Ensemble                         | 208        | Synth Strings 3              | SynStrs3            |
| Ensemble                         | 209        | Synth Strings 4              | SynStrs4            |
| Ensemble                         | 210        | Stereo Slow Strings          | SSlowStr            |
| Ensemble                         | 211        | Strings and Brass            | Str&Bras            |
| Ensemble                         | 212        | Legato Strings               | LegatStr            |
| Ensemble                         | 213        | Orchestra                    | Orchstr             |
| Ensemble                         | 214        | 60's Strings                 | 60'sStr             |
| Ensemble                         | 215        | Solo Strings                 | SoloStr             |
| Ensemble                         | 216        | Choir Aahs 1                 | ChoirAah            |
| Ensemble                         | 217        | Choir Aahs 2                 | ChoirAh2            |
| Ensemble                         | 218        | Humming                      | Humming             |
| Ensemble                         | 219        | Voice Oohs                   | VoiceOoh            |
| Ensemble                         | 220        | Analog Voice                 | AnaVoice            |
| Ensemble                         | 221        | Synth Voice                  | SynVoice            |
| Ensemble                         | 222        | Bass Hit Plus                | BassHit             |
| Ensemble                         | 223        | Orchestra Hit 1              | OrchHit             |
| Ensemble                         | 224        | Orchestra Hit 2              | OrchHi2             |
| Ensemble                         | 225        | Euro Hit                     | Eu roHit            |
| Ensemble                         | 226        | 6th Hit                      | 6thHit              |
| Brass                            | 227        | Trumpet 1                    | Trumpet             |
| Brass                            | 228        | Trumpet 2                    | Trumpet2            |
| Brass                            | 229        | Trumpet 3                    | Trumpet3            |
| Brass                            | 230        | Dark Trumpet Soft            | DarkTrp             |
| Brass                            | 231        | Sweet Trumpet                | SweetTp             |
| Brass                            | 232        | Trombone 1                   | Trombone            |
| Brass                            | 233        | Trombone 2                   | Trmbone2            |
| Brass                            | 234        | Bright Trombone              | BritBone            |
| Brass                            | 235        | Tuba 1                       | Tuba                |
| Brass                            | 236        | Tuba 2                       | Tuba2               |
| Brass                            | 237        | Muted Trumpet 1              | MuteTrp1            |
| Brass                            | 238        | Muted Trumpet 2              | MuteTrp2            |
| Brass                            | 239        | French Horn 1                | FrHorn              |
| Brass                            | 240        | French Horn 2 (warm)         | FrHorn2             |
| Brass                            | 241        | Brass Section 1              | Brass               |
| Brass                            | 242        | Brass Section 2 (octave mix) | Brass2              |
| Brass                            | 243        | Brass Section 3              | Brass3              |
| Brass                            | 244        | Brass Section 4              | Brass4              |
| Brass                            | 245        | Brass Section 5              | Brass5              |
| Brass                            | 246        | Brass Band                   | BrasBand            |

## Voice List

| Classify   | No. | Full english Name          | English Abbr |
|------------|-----|----------------------------|--------------|
| Brass      | 247 | Bright Brass Section       | BrBraSec     |
| Brass      | 248 | Brass & Strings            | Bras&Str     |
| Brass      | 249 | Synth Brass 1              | SynBras1     |
| Brass      | 250 | Synth Brass 2              | SynBras2     |
| Brass      | 251 | Synth Brass 3              | SynBras3     |
| Brass      | 252 | Synth Brass 4              | SynBras4     |
| Brass      | 253 | Analog Synth Brass 1       | AnaBras1     |
| Brass      | 254 | Analog Synth Brass 2       | AnaBras2     |
| Brass      | 255 | Jump Brass                 | JumpBras     |
| Brass      | 256 | Synth Brass & Strings 1    | SyBr&St1     |
| Reed       | 257 | Soprano Sax 1              | SprnoSax     |
| Reed       | 258 | Soprano Sax 2              | SprnSax2     |
| Reed       | 259 | Sweet Soprano Sax          | SweSpSax     |
| Reed       | 260 | Alto Sax                   | AltoSax      |
| Reed       | 261 | Soft Alto Sax              | SoftAlto     |
| Reed       | 262 | Tenor Sax 1                | TenoSax      |
| Reed       | 263 | Tenor Sax 2                | TenoSax2     |
| Reed       | 264 | Baritone Sax               | BariSax      |
| Reed       | 265 | Sweet Oboe                 | SweetOboe    |
| Reed       | 266 | Oboe 1                     | Oboe         |
| Reed       | 267 | English Horn 1             | EngHorn      |
| Reed       | 268 | Bassoon 1                  | Bassoon      |
| Reed       | 269 | Clarinet 1                 | Clarinet     |
| Reed       | 270 | Clarinet 2                 | Clarinet2    |
| Pipe       | 271 | Piccolo                    | Piccolo      |
| Pipe       | 272 | Flute                      | Flute        |
| Pipe       | 273 | Sweet Flute                | SweetFlut    |
| Pipe       | 274 | Recorder                   | Recorder     |
| Pipe       | 275 | Sweet Pan Flute            | SwPanFu      |
| Pipe       | 276 | Pan Flute                  | PanFlute     |
| Pipe       | 277 | Blown Bottle               | Bottle       |
| Pipe       | 278 | Shakuhachi                 | Shakhchi     |
| Pipe       | 279 | Whistle 1                  | Whistle      |
| Pipe       | 280 | Whistle 2                  | Whistle2     |
| Pipe       | 281 | Ocarina                    | Ocarina      |
| Synth Lead | 282 | Lead 1 (square)            | SquareLd     |
| Synth Lead | 283 | Square                     | Square       |
| Synth Lead | 284 | Lead 1b (sine)             | SineLead     |
| Synth Lead | 285 | Square Lead 1              | SquarLd1     |
| Synth Lead | 286 | Lead 1a (square 2)         | SquarLd2     |
| Synth Lead | 287 | Lead 2a (sawtooth 2)       | SawLead2     |
| Synth Lead | 288 | Lead 2d (sequenced analog) | SquAnaLd     |
| Synth Lead | 289 | Lead 2 (sawtooth)          | SawLead1     |
| Synth Lead | 290 | Lead 2b (saw + pulse)      | SawPlsLd     |
| Synth Lead | 291 | Lead 2c (double sawtooth)  | DubSawLd     |
| Synth Lead | 292 | Lead 3 (calliope)          | CalliopLd    |
| Synth Lead | 293 | Lead 4 (chiff)             | ChiffLd      |
| Synth Lead | 294 | Lead 5 (charang)           | CharanLd     |
| Synth Lead | 295 | Lead 5a (wire lead)        | WireLead     |
| Synth Lead | 296 | Lead 6 (voice)             | VoiceLd      |
| Synth Lead | 297 | Lead 7 (fifths)            | FifthsLd     |
| Synth Lead | 298 | Lead 8 (bass + lead)       | BassLead     |
| Synth Lead | 299 | Lead 8a (soft wrl)         | SftWrLd      |
| Synth Pad  | 300 | Pad 1 (new age)            | NewAgePd     |
| Synth Pad  | 301 | New Year Pad               | NewYrPd      |
| Synth Pad  | 302 | Pad 2 (warm)               | WarmPad      |
| Synth Pad  | 303 | Pad 2a (sine pad)          | SinePad      |
| Synth Pad  | 304 | Pad 3 (polysynth) 1        | PolySyPd     |
| Synth Pad  | 305 | Pad 4 (choir)              | ChoirPad     |
| Synth Pad  | 306 | Pad 4a (itopia)            | ItopiaPd     |
| Synth Pad  | 307 | Pad 5 (bowed) 1            | BowedPad     |

## Voice List

| Classify            | No. | Full english Name            | English Abbr |
|---------------------|-----|------------------------------|--------------|
| Synth Pad           | 308 | Pad 6 (metallic) 1           | MetalPad     |
| Synth Pad           | 309 | Pad 7 (halo) 1               | HaloPad      |
| Synth Pad           | 310 | Pad 8 (sweep) 1              | SweepPad     |
| Synth Pad           | 311 | FX 1 (rain)                  | FXRain       |
| Synth Pad           | 312 | FX 2 (soundtrack)            | Soundtrk     |
| Synth Pad           | 313 | FX 3a (synth mallet)         | SynMallet    |
| Synth Pad           | 314 | FX 3 (crystal)               | Crystal      |
| Synth Pad           | 315 | FX 4 (atmosphere)            | Atmosphr     |
| Synth Pad           | 316 | Warm Air                     | WarmAir      |
| Synth Pad           | 317 | FX 5 (brightness)            | Bright       |
| Synth Pad           | 318 | FX 6 (goblins)               | Goblins      |
| Synth Pad           | 319 | FX 7 (echoes) 1              | Echoes       |
| Synth Pad           | 320 | FX 7a (echo bell) 1          | EchoBell     |
| Synth Pad           | 321 | FX 7b (echo pan)             | EchoPan      |
| Synth Pad           | 322 | FX 8 (sci-fi)                | Sci-Fi       |
| Ethnic Misc.        | 323 | Sitar 1                      | Sitar        |
| Ethnic Misc.        | 324 | Sitar 2 (bend)               | Sitar2       |
| Ethnic Misc.        | 325 | Banjo                        | Banjo        |
| Ethnic Misc.        | 326 | Shamisen                     | Shamisen     |
| Ethnic Misc.        | 327 | Koto                         | Koto         |
| Ethnic Misc.        | 328 | Taisho Koto                  | TaishoKt     |
| Ethnic Misc.        | 329 | Kalimba                      | Kalimba      |
| Ethnic Misc.        | 330 | Bag Pipe                     | Bagpipe      |
| Ethnic Misc.        | 331 | Fiddle                       | Fiddle       |
| Ethnic Misc.        | 332 | Shanai                       | Shanai       |
| Percussive          | 333 | Tinkle Bell                  | TnklBell     |
| Percussive          | 334 | Steel Drums                  | SteelDrm     |
| Percussive          | 335 | Woodblock                    | WoodBlok     |
| SFX                 | 336 | Seashore                     | Seashore     |
| SFX                 | 337 | Thunder                      | Thunder      |
| SFX                 | 338 | Telephone Ring 1             | Telephone    |
| SFX                 | 339 | Applause                     | Applause     |
| Combined Voice      | 340 | Stereo Piano & Strings Pad   | StPn&Str     |
| Combined Voice      | 341 | Stereo Piano & Choir         | StPn&Cho     |
| Combined Voice      | 342 | Stereo Piano & Synth Strings | StPn&Syn     |
| Combined Voice      | 343 | Stereo Piano & Warm Pad      | StPn&Pad     |
| Combined Voice      | 344 | Rock Organ & Strings         | RoOr&Str     |
| Combined Voice      | 345 | Steel Guitar & Warm Pad      | StGt&Pad     |
| Combined Voice      | 346 | Orchestra                    | Orchest      |
| Combined Voice      | 347 | Full Strings 1               | FullStr1     |
| Combined Voice      | 348 | Symphonic                    | Symphon      |
| Chinese Instruments | 349 | GuZheng                      | GuZheng      |
| Chinese Instruments | 350 | PiPa                         | PiPa         |
| Chinese Instruments | 351 | ErHu 1                       | ErHu1        |
| Chinese Instruments | 352 | Bandi                        | Bandi        |
| Chinese Instruments | 353 | Hulusi                       | Hulusi       |
| Chinese Instruments | 354 | LuSheng 1                    | LuShen1      |
| Chinese Instruments | 355 | SuoNa                        | SuoNa        |
| Chinese Instruments | 356 | Paixiao                      | Paixiao      |
| Drum Set            | 357 | Standard Set                 | StandSet     |
| Drum Set            | 358 | Room Set                     | RoomSet      |
| Drum Set            | 359 | Power Set                    | PowerSet     |
| Drum Set            | 360 | Jazz Set                     | JazzSet      |

## Style List

| Classify | No. | Full english Name | English Abbr |
|----------|-----|-------------------|--------------|
| 8 BEAT   | 1   | 8Beat Piano       | 8BtPiano     |
| 8 B EAT  | 2   | 8Beat 1           | 8Beat 1      |
| 8 B EAT  | 3   | 8Beat Shuffle     | 8BtShufl     |
| 8 B EAT  | 4   | Guitar Pop 1      | GtPop1       |
| 8 B EAT  | 5   | 8Beat Hip Hop     | 8BtHiHop     |
| 8 B EAT  | 6   | 8Beat R&B         | 8Beat R&B    |
| 8 B EAT  | 7   | 8Beat Pop         | 8BtPop       |
| 8 B EAT  | 8   | Pop Funk 1        | PopFunk1     |
| 8 B EAT  | 9   | Rhythm & Beat 1   | Rhy&Bt 1     |
| 8 B EAT  | 10  | 8Beat Disco 1     | 8BtDisc1     |
| 8 B EAT  | 11  | 8Beat Rock        | 8BtRock      |
| 8 B EAT  | 12  | 8Beat 2           | 8Beat 2      |
| 8 B EAT  | 13  | Sweet Beat        | SweetBt      |
| 8 B EAT  | 14  | 8Beat Dance       | 8BtDance     |
| 8 B EAT  | 15  | 8Beat 3           | 8Beat 3      |
| 8 B EAT  | 16  | 60's 8Beat        | 60's8Bt      |
| 16 BEAT  | 17  | 16Beat 1          | 16Beat 1     |
| 16 BEAT  | 18  | 16Beat Funk 1     | 16BtFuk1     |
| 16 BEAT  | 19  | 16Beat Ballad 1   | 16BtBld1     |
| 16 BEAT  | 20  | 16Beat R&B        | 16BtR&B      |
| 16 BEAT  | 21  | Pop 16Beat 1      | Pop16Bt 1    |
| 16 BEAT  | 22  | 16Beat Dance      | 16BtDanc     |
| 16 BEAT  | 23  | 16Beat 2          | 16Beat 2     |
| 16 BEAT  | 24  | Modern 16Beat     | Modrn16B     |
| 16 BEAT  | 25  | 16Beat Hot        | 16BtHot      |
| 16 BEAT  | 26  | 16Beat Modern     | 16BtModr     |
| 16 BEAT  | 27  | 16Beat 3          | 16Beat 3     |
| 16 BEAT  | 28  | Cool Beat         | CoolBeat     |
| 16 BEAT  | 29  | 16Beat Ballad 2   | 16BtBld2     |
| 16 BEAT  | 30  | 16Beat 4          | 16Beat4      |
| 16 BEAT  | 31  | Pop Shuffle       | PopShufl     |
| POP      | 32  | Pop Rock 1        | PopRock1     |
| POP      | 33  | Pop Dance 1       | PopDanc1     |
| POP      | 34  | Pop Fusion        | PopFusn      |
| POP      | 35  | Analog Night 1    | AnalgNt 1    |
| POP      | 36  | 6/8 Pop           | 6/8Pop       |
| POP      | 37  | Brit. Pop 1       | BritPop1     |
| POP      | 38  | Brit. Pop 2       | BritPop2     |
| POP      | 39  | Pop Hit           | PopHit       |
| POP      | 40  | Fusion Shuffle    | FusShufl     |
| POP      | 41  | Pop Beat          | PopBeat      |
| POP      | 42  | Soft Beat         | SoftBeat     |
| POP      | 43  | 60's Pop          | 60'sPop      |
| POP      | 44  | Sting Latin       | StigLatn     |
| BALLAD   | 45  | R&B Ballad 1      | R&BBad1      |
| BALLAD   | 46  | Guitar Ballad     | GtBallad     |
| BALLAD   | 47  | Ballad Rock       | BalladRk     |
| BALLAD   | 48  | Piano Pop         | PianoPop     |
| BALLAD   | 49  | Soft Ballad       | SoftBald     |
| BALLAD   | 50  | Natural Ballad    | NatuBld      |
| BALLAD   | 51  | Love Ballad       | LoveBld      |
| BALLAD   | 52  | Easy Ballad       | EasyBld      |
| BALLAD   | 53  | Slow Ballad       | SlowBald     |
| BALLAD   | 54  | Folk Ballad       | FolkBld      |
| BALLAD   | 55  | Pop Ballad 1      | PopBld1      |
| BALLAD   | 56  | EP Ballad         | EPBallad     |
| ROCK     | 57  | Rock              | Rock         |
| ROCK     | 58  | New Wave          | NewWave      |
| ROCK     | 59  | Ska               | Ska          |
| ROCK     | 60  | Slow Rock         | SlowRock     |
| ROCK     | 61  | 70's Rock & Roll  | 70'sRock     |
| ROCK     | 62  | Folk Rock         | FolkRock     |

## Style List

| Classify     | No. | Full english Name | English Abbr |
|--------------|-----|-------------------|--------------|
| ROCK         | 63  | Soft Rock         | SoftRock     |
| ROCK         | 64  | Easy Rock         | EasyRock     |
| ROCK         | 65  | New Shuffle       | NewShuffl    |
| ROCK         | 66  | Rock Hip Hop      | RkHipHop     |
| ROCK         | 67  | Rock & Roll 1     | R'N'R1       |
| ROCK         | 68  | Rock & Roll 2     | R'N'R2       |
| BALLROOM     | 69  | Tango 1           | Tango 1      |
| BALLROOM     | 70  | Spain Matador     | Matador      |
| BALLROOM     | 71  | Twist 1           | Twist 1      |
| BALLROOM     | 72  | Big Band Fox      | BandFox      |
| BALLROOM     | 73  | Tango 2           | Tango 2      |
| BALLROOM     | 74  | Slow Fox          | SlowFox      |
| BALLROOM     | 75  | Slow Waltz 1      | SlowWlz1     |
| BALLROOM     | 76  | Swing Fox         | SwingFox     |
| BALLROOM     | 77  | Salsa 1           | Salsa 1      |
| BALLROOM     | 78  | Cha Cha 1         | ChaCha1      |
| BALLROOM     | 79  | Cha Cha 2         | ChaCha2      |
| BALLROOM     | 80  | Beguine 1         | Beguine 1    |
| BALLROOM     | 81  | Beguine 2         | Beguine 2    |
| BALLROOM     | 82  | Rumba 1           | Rumba 1      |
| BALLROOM     | 83  | Samba 1           | Samba 1      |
| BALLROOM     | 84  | Jive              | Jive         |
| BALLROOM     | 85  | Fox Trot          | FoxTrot      |
| DANCE        | 86  | Techno 1          | Techno 1     |
| DANCE        | 87  | Hip Hop 1         | HipHop1      |
| DANCE        | 88  | Dream Dance       | DrnDance     |
| DANCE        | 89  | House             | House        |
| DANCE        | 90  | Down Beat         | Down Beat    |
| DANCE        | 91  | Progressive       | Progress     |
| DANCE        | 92  | Rap 1             | Rap 1        |
| DANCE        | 93  | Disco             | Disco        |
| DANCE        | 94  | Soft Disco        | Soft Disc    |
| DANCE        | 95  | Disco Party       | DscParty     |
| DANCE        | 96  | 70's Disco        | 70'sDisc     |
| DANCE        | 97  | Club Dance        | Club Danc    |
| DANCE        | 98  | Euro Dance        | Euro Danc    |
| DANCE        | 99  | Hip Hop 2         | HipHop2      |
| SOUL & FUNK  | 100 | Funk 1            | Funk 1       |
| SOUL & FUNK  | 101 | Classic Funk      | ClasFunk     |
| SOUL & FUNK  | 102 | Gospel Swing      | Go pSwing    |
| SOUL & FUNK  | 103 | Gospel            | Gospel       |
| SOUL & FUNK  | 104 | Funk 2            | Funk 2       |
| SOUL & FUNK  | 105 | Electric Funk     | ElecFunk     |
| SOUL & FUNK  | 106 | Groove Funk       | GrooveFk     |
| SOUL & FUNK  | 107 | Cool Funky        | Col Funky    |
| SOUL & FUNK  | 108 | Jazz Funk         | JazzFu nk    |
| SOUL & FUNK  | 109 | Groove            | Groove       |
| SOUL & FUNK  | 110 | Soul              | Soul         |
| SOUL & FUNK  | 111 | Hip Hop Beat      | Hip Hop Bt   |
| SOUL & FUNK  | 112 | R&B               | R&B          |
| SOUL & FUNK  | 113 | Soul Beat         | SoulBeat     |
| SWING & JAZZ | 114 | Latin Jazz 1      | LatinJz1     |
| SWING & JAZZ | 115 | Big Band          | BigBand      |
| SWING & JAZZ | 116 | Dixieland 1       | Dixland1     |
| SWING & JAZZ | 117 | Broadway Big Band | BwayBand     |
| SWING & JAZZ | 118 | Swing             | Swing        |
| SWING & JAZZ | 119 | Latin Jazz 2      | LatinJz 2    |
| SWING & JAZZ | 120 | Fusion            | Fusion       |
| SWING & JAZZ | 121 | Acid Jazz         | AcidJazz     |
| SWING & JAZZ | 122 | Cool Jazz Ballad  | CoolJzBd     |
| SWING & JAZZ | 123 | Swing Shuffle     | SwingSfl     |
| SWING & JAZZ | 124 | Big Band Medium   | BandMid      |

## Style List

| Classify            | No. | Full english Name   | English Abbr |
|---------------------|-----|---------------------|--------------|
| COU NTRY            | 125 | Country Pop 1       | CntyPop1     |
| COU NTRY            | 126 | Bluegrass 1         | Bluegrs1     |
| COU NTRY            | 127 | Country 8Beat       | Ct8Beat      |
| COU NTRY            | 128 | Modern Country      | ModernCt     |
| COU NTRY            | 129 | Country Pop 2       | CntyPop2     |
| COU NTRY            | 130 | Bluegrass 2         | Bluegrs2     |
| COU NTRY            | 131 | 2/4 Country         | 2/4Cntry     |
| COU NTRY            | 132 | Country Quick Steps | QuickStp     |
| COU NTRY            | 133 | Country Folk        | CntyFolk     |
| COU NTRY            | 134 | Country Shuffle     | CnyShuffl    |
| Latin & Latin Dance | 135 | Bossa Nova          | BossaNov     |
| Latin & Latin Dance | 136 | Latin               | Latin        |
| Latin & Latin Dance | 137 | Tikitikita          | Tikitkita    |
| Latin & Latin Dance | 138 | Lambada             | Lambada      |
| Latin & Latin Dance | 139 | Pop Cha Cha 1       | PChaCha1     |
| Latin & Latin Dance | 140 | Pop Cha Cha 2       | PChaCha2     |
| Latin & Latin Dance | 141 | Salsa 2             | Salsa2       |
| Waltz & TRADITIONAL | 142 | Waltz               | Waltz        |
| Waltz & TRADITIONAL | 143 | Old Waltz           | OldWaltz     |
| Waltz & TRADITIONAL | 144 | English Waltz       | EngWaltz     |
| Waltz & TRADITIONAL | 145 | German Waltz        | GemWaltz     |
| Waltz & TRADITIONAL | 146 | ViennaWaltz         | VinaWtz      |
| Waltz & TRADITIONAL | 147 | Slow Waltz 2        | SlwWltz2     |
| Waltz & TRADITIONAL | 148 | Jazz Waltz          | JzWaltz      |
| Waltz & TRADITIONAL | 149 | Polka               | Polka        |
| Waltz & TRADITIONAL | 150 | March               | March        |
| CHINESE FOLK        | 151 | Chinese R&B 1       | ChnR&B1      |
| CHINESE FOLK        | 152 | GuangXi Folk        | GuangXi      |
| CHINESE FOLK        | 153 | Chinese Folk 1      | ChnFolk1     |
| CHINESE FOLK        | 154 | NeiMeng Folk        | NeiMFolk     |
| CHINESE FOLK        | 155 | Jiang Nan Folk1     | JangNan1     |
| CHINESE FOLK        | 156 | XinJiang Folk       | XJangFok     |
| CHINESE FOLK        | 157 | YangGe              | YangGe       |
| CHINESE FOLK        | 158 | YunNan              | YunNan       |
| CHINESE FOLK        | 159 | Jubilance           | Jubilanc     |
| CHINESE FOLK        | 160 | GuangDong           | GungDong     |

## Song list

| Classify       | No. | Full english Name  | English Abbr |
|----------------|-----|--|--------------|
| FOLK & COUNTRY | 1   | Jambalaya  | Jambalay     |
| FOLK & COUNTRY | 2   | Ding! Dong! Merrily On High  | DingDong     |
| FOLK & COUNTRY | 3   | Battle Hymne Of The Republic   | Battle       |
| FOLK & COUNTRY | 4   | The Old Gray Mare  | GrayMare     |
| FOLK & COUNTRY | 5   | American Patrol  | USPatrol     |
| FOLK & COUNTRY | 6   | Christmas Is Coming  | IsComing     |
| FOLK & COUNTRY | 7   | Sippin' Gider Through A Straw  | SCTStraw     |
| FOLK & COUNTRY | 8   | Christmas Sound  | Sound        |
| GOLDEN & POP   | 9   | On London Bridge   | LdBridge     |
| GOLDEN & POP   | 10  | Are You Lonesome Tonight   | Lonesome     |
| GOLDEN & POP   | 11  | Der Deitcher's Dog   | DerD Dog     |
| GOLDEN & POP   | 12  | Joy To The World   | JoyWorld     |
| GOLDEN & POP   | 13  | Silent Night   | SltNight     |
| GOLDEN & POP   | 14  | Ave Maria  | AveMaria     |
| GOLDEN & POP   | 15  | Five Hundred Miles   | FHMiles      |
| GOLDEN & POP   | 16  | Happy New Year   | HappyNY      |
| GOLDEN & POP   | 17  | It's Beginning To Look A Lot Like Christmas                            | LikeXmas     |
| GOLDEN & POP   | 18  | Jeanie With The Light Brown Hair                                       | Light Hair   |
| GOLDEN & POP   | 19  | My Bonnie  | MyBonnie     |
| GOLDEN & POP   | 20  | Song Of The Pearlfisher  | SongOfTP     |
| CLASSICAL      | 21  | Swan   | Swan         |
| CLASSICAL      | 22  | Prelude To Act 2 (Swan Lake)   | SwanLak1     |
| CLASSICAL      | 23  | Valse (Swan lake)  | SwanLak2     |
| CLASSICAL      | 24  | The Happy Farmer   | HpFarmer     |
| CLASSICAL      | 25  | The Sleeping Beauty  | SleepBty     |
| CLASSICAL      | 26  | La Traviata  | LaTravia     |
| CLASSICAL      | 27  | Wiegenlied   | Wiegenli     |
| CLASSICAL      | 28  | Mov.2 Adagio Non Troppo Piano Sonata No.9 in D                         | Sonata9      |
| CLASSICAL      | 29  | Mov.1 Andante Grazioso Piano Sonata No.11 In A [Alla Tur Sonata 11 ca] | Sonata11     |
| CLASSICAL      | 30  | Prelude In C   | Prelude      |
| CLASSICAL      | 31  | Chinese Dance  | ChDance      |
| CLASSICAL      | 32  | Emperors Waltz   | EmprWaltz    |
| CLASSICAL      | 33  | March Militaire  | MilMar1      |
| CLASSICAL      | 34  | Symphony No.40   | Symphony     |
| JAZZ & FUSION  | 35  | ShanZhaShu   | ShanZhaS     |
| JAZZ & FUSION  | 36  | You Are My Sunshine  | MySun        |
| JAZZ & FUSION  | 37  | June Samba   | Ju nSamba    |
| JAZZ & FUSION  | 38  | Funk   | Funk         |
| JAZZ & FUSION  | 39  | I Can.....   | I Can...     |
| JAZZ & FUSION  | 40  | Sea Shore  | SeaShore     |

## Song list

| Classify      | No. | Full english Name                        | English Abbr |
|---------------|-----|--|--------------|
| JAZZ & FUSION | 41  | Guitar & Saxphone                        | Gt&Sax       |
| JAZZ & FUSION | 42  | The Hip Hop's Night                      | HipHopNt     |
| JAZZ & FUSION | 43  | Blue Lunch                               | BlueLunch    |
| JAZZ & FUSION | 44  | Cobweb                                   | Cobweb       |
| JAZZ & FUSION | 45  | Wine                                     | Wine         |
| JAZZ & FUSION | 46  | Jazz Old Man                             | JzOldMan     |
| JAZZ & FUSION | 47  | Dark Eyes                                | DarkEyes     |
| JAZZ & FUSION | 48  | Carlos                                   | Carlos       |
| JAZZ & FUSION | 49  | Sad                                      | Sad          |
| JAZZ & FUSION | 50  | The Jazz                                 | TheJazz      |
| PIANO         | 51  | Fur Elise                                | FurElise     |
| PIANO         | 52  | Military March                           | Mmarch       |
| PIANO         | 53  | Habanera                                 | Habanera     |
| PIANO         | 54  | Minuet                                   | Minuet       |
| PIANO         | 55  | Austria Variation                        | Avariati     |
| PIANO         | 56  | Old Macdonald Had A Farm                 | OldAFarm     |
| PIANO         | 57  | Wedding March                            | Wedding      |
| PIANO         | 58  | 2-Part Invention #13 In A Minor.B.W. Iii | Invention    |
| PIANO         | 59  | Minuet In G                              | MinuetG      |
| PIANO         | 60  | Turkish March                            | TurkishM     |
| PIANO         | 61  | Hey Diddle Diddle                        | HeDiddle     |
| PIANO         | 62  | Italian Polka                            | ItaPolka     |
| PIANO         | 63  | Moseta Dance                             | MosetaDn     |
| PIANO         | 64  | Bullie Dance                             | BullieDn     |
| PIANO         | 65  | Waltz in A Flat Op.39 No.15              | Waltz 1      |
| PIANO         | 66  | Wild Rose                                | WildRose     |
| PIANO         | 67  | Away In A Manger                         | AwayInAM     |
| PIANO         | 68  | Jack & Jill                              | JackJill     |
| PIANO         | 69  | Angles We Have Heard On High             | Angles       |
| PIANO         | 70  | Waltz                                    | Waltz        |
| PIANO         | 71  | Did You Ever See A Lassie                | Lassie       |
| PIANO         | 72  | Chopsticks                               | Chopstick    |
| PIANO         | 73  | Four Little Swans                        | FLSwans      |
| PIANO         | 74  | Old France                               | OldFrance    |
| PIANO         | 75  | Jesus Saviour Pilot Me                   | PilotMe      |
| PIANO         | 76  | Eclogue                                  | Eclogue      |
| PIANO         | 77  | Santa Claus Is Coming To Town            | SantaCT      |
| PIANO         | 78  | Brave Cavalier                           | Cavalier     |
| PIANO         | 79  | America The Beautiful                    | USFair       |
| PIANO         | 80  | Music Box Dancer                         | Dancer       |



## WEEE-Declaration / Disposal



Your product is designed and manufactured with materials and components of high quality, which are recyclable and can be reused. The symbol means that your product should be disposed of separately from household waste when it reaches its end of life. Please dispose of this equipment at your local collection point or recycling center. Please help to protect the environment in which we all live.

All specifications and appearances are subject to change without notice. All information was correct at time of printing. Musikhaus Kirstein GmbH does not guarantee for the accuracy or completeness of any description, photograph or statement contained in this manual. Printed colors and specifications may vary slightly from product. Products from Musikhaus Kirstein GmbH are only sold through authorized dealer. Distributors and dealers are not agents of Musikhaus Kirstein GmbH and have no authority to bind Musikhaus Kirstein GmbH legally in any way. This manual is protected by copyright. Any copying or reprint, even in excerpts, is only allowed with written consent of Musikhaus Kirstein GmbH. The same applies to reproduction or copying of images, even in altered form.

### **Musikhaus Kirstein GmbH**

Bernbeurener Strasse 11

86956 Schongau

Telefon: 0049-8861-909494-0

Telefax: 0049-8861-909494-19

[www.kirstein.de](http://www.kirstein.de)

 **KIRSTEIN.de**