

# Classic Cantabile KH-238 Kopfhörer HiFi dynamisch

ArtNr.: 00016331



## Bedienungsanleitung

Version: 10.2024

Vielen Dank, dass Sie sich für dieses Produkt entschieden haben. Um sicherzustellen, dass Sie mit dem Classic Cantabile Kopfhörer voll und ganz zufrieden sind, lesen Sie sorgfältig und verstehen Sie diese Bedienungsanleitung, bevor Sie unser Produkt verwenden. Bewahren Sie diese Bedienungsanleitung an einem sicheren Ort auf. Die Bedienungsanleitung muss an alle nachfolgenden Anwender weitergegeben werden.



Bedienungsanleitung beachten!



**WARNUNG**

Mit dem Signalwort **WARNUNG** sind die Gefahren gekennzeichnet, die ohne Vorsichtsmaßnahmen zu schweren Verletzungen führen können.



**HINWEIS**

Mit dem Signalwort **HINWEIS** sind allgemeine Vorsichtsmaßnahmen gekennzeichnet, die im Umgang mit dem Produkt beachtet werden sollen.



**HINWEIS**

Bilder und Bildschirmdarstellungen in dieser Bedienungsanleitung können vom Erscheinungsbild des tatsächlichen Produkts geringfügig abweichen, solange dies keine negativen Auswirkungen auf die technischen Eigenschaften und Sicherheit des Produkts hat.



**HINWEIS**

Alle personenbezogenen Formulierungen in dieser Bedienungsanleitung sind geschlechtsneutral zu betrachten.

Diese Bedienungsanleitung gilt für Personen, die von einer für ihre Sicherheit verantwortlichen Person beaufsichtigt oder in die Bedienung des Gerätes eingewiesen wurden und nachgewiesen haben mit dem Gerät umgehen zu können.



**WARNUNG**

**Kinder sollten beaufsichtigt werden, um sicherzustellen, dass sie nicht mit dem Kopfhörer spielen.  
Der Kopfhörer ist kein Spielzeug**

Alle Informationen in dieser Bedienungsanleitung wurden nach bestem Wissen und Gewissen kontrolliert. Weder Autor noch Herausgeber können jedoch für Schäden haftbar gemacht werden, die in Zusammenhang mit der Verwendung dieser Bedienungsanleitung stehen.

Sonstige, in diesem Dokument aufgeführte Produkt-, Marken- und Unternehmensbezeichnungen können die Warenzeichen ihrer jeweiligen Eigentümer sein. Die Einhaltung sämtlicher anwendbarer Urheberrechtsgesetze liegt in der Verantwortung des Anwenders dieses Dokuments.

---

**Detaillierte Sicherheitshinweise:****⚠ HINWEIS**

- Lesen Sie diese Anweisungen und bewahren Sie diese Anleitung auf.
- Beachten Sie alle Warnungen. Befolgen Sie alle Anweisungen.
- Verwenden Sie dieses Gerät nicht im Wasser.
- Reinigen Sie das Gerät nur mit einem trockenen Tuch.
- Legen Sie das Gerät nicht in auf Wärmequellen wie Heizkörpern, Öfen oder andere Geräte, die Wärme erzeugen.
- Achten Sie auf die Lautstärke! Hören mit zu hohem Lautstärkepegel kann Ihr Gehör dauerhaft schädigen.
- Wenden Sie sich bezüglich aller Reparatur- /Wartungsarbeiten an qualifiziertes Servicepersonal. Öffnen Sie das Gerät bzw. das Gehäuse nicht eigenmächtig. Eine Wartung ist erforderlich, wenn das Gerät auf irgendeine Weise beschädigt wurde, z. B. wenn das Kabel beschädigt ist, Flüssigkeit verschüttet wurde oder das Gerät Regen oder Feuchtigkeit ausgesetzt war, nicht ordnungsgemäß funktioniert.

**Beschreibung:****Funktion:**

Der Kopfhörer kann mit jedem Abspielgerät (z.B. CD-Player) als auch Instrument (z.B. E-Drumset, Keyboard oder Piano) verbunden werden. Hierbei ist je nach Buchse lediglich auf den Einsatz der korrekten 3,5 mm Klinke oder der 6,3 mm Klinke des Adapters zu achten.(Adapter liegt bei)

**⚠ WARNUNG**

Achten Sie auf die Lautstärke! Hören mit zu hohem Lautstärkepegel kann Ihr Gehör dauerhaft schädigen.

## Wartung

Ihr Gerät erfordert keine besondere Wartung. Wenden Sie sich jedoch im Falle einer Fehlfunktion an ein zugelassenes Servicecenter oder den Hersteller

## Reinigung

Verwenden Sie zur Reinigung ein fusselfreies und nur leicht feuchtes Tuch.

## Technische Spezifikationen:

**System:** dynamische Kopfhörer

**Nennimpedanz:** 32 Ohm

**Lautsprecher:** Stereo

**Frequenzbereich:** 20-20000 Hz

**Empfindlichkeit:** 110dB SPL

### WEEE-Erklärung

(Waste of Electrical and Electronic Equipment)

Ihr Produkt wurde unter Verwendung hochwertiger Materialien und Komponenten entwickelt und hergestellt, die recycelbar und wiederverwendbar sind. Das Symbol bedeutet, dass Ihr Produkt am Ende seiner Lebensdauer vom Hausmüll getrennt entsorgt werden muss.

Entsorgen Sie dieses Gerät bei Ihrer örtlichen Sammelstelle oder Recyclingstelle. Bitte helfen Sie mit, die Umwelt zu schützen, in der wir alle leben.

Alle technischen Daten und Erscheinungsbilder können ohne vorherige Ankündigung geändert werden. Alle Angaben waren zum Zeitpunkt der Drucklegung korrekt. Die Musikhaus Kirstein GmbH übernimmt keine Gewähr für die Richtigkeit oder Vollständigkeit der in diesem Handbuch enthaltenen Beschreibungen, Fotos oder Aussagen. Gedruckte Farben und Spezifikationen können geringfügig vom Produkt abweichen. Produkte der Musikhaus Kirstein GmbH werden nur über autorisierte Händler vertrieben. Distributoren und Händler sind keine Vertreter der Musikhaus Kirstein GmbH und nicht befugt, die Musikhaus Kirstein GmbH in irgendeiner Weise rechtlich zu binden.

Diese Bedienungsanleitung ist urheberrechtlich geschützt. Die Vervielfältigung dieser Bedienungsanleitung, auch auszugsweise, ist nur mit Genehmigung der Musikhaus Kirstein GmbH gestattet. Gleiches gilt für die Vervielfältigung oder das Kopieren von Bildern, auch in geänderter Form.

© 2024

 **KIRSTEIN.de**

**Musikhaus Kirstein GmbH**

**Bernbeurener Str. 11**

**D-86956 Schongau**

**info@kirstein.de**

**www.kirstein.de**

**Telefon/Phone: +49(0)8861 / 90 94 94 -0**



# Classic Cantabile KH-238 Headphones HiFi dynamic

Item number: 00016331



## User Manual

Version: 10.2024

Thank you for choosing this product.

To ensure that you are fully satisfied with the Classic Cantabile headphones, read this manual carefully and understand these instructions before using our product. Keep these operating instructions in a safe place. The operating instructions must be passed on to all subsequent users.



Please carefully follow the instructions!



**WARNING**

The signal word **WARNING** indicates the dangers that can lead to serious injuries without precautionary measures.



**NOTE**

The signal word **NOTE** indicates general precautionary measures that should be observed when handling the product.



**NOTE**

Images and screen shots in this manual may differ slightly from the appearance of the actual product as long as this has no negative effects on the technical properties and safety of the product.



**NOTE**

All personal formulations in these operating instructions are to be considered gender-neutral.

These operating instructions apply to persons who have been supervised by a person responsible for their safety or who have been instructed in the operation of the device and have demonstrated that they can handle the device.



**WARNING**

**Children should be supervised to ensure that they do not play with the device.**

**Do not leave children unattended. The product is not a toy!**

All information in this operating manual has been checked to the best of our knowledge and belief. However, neither the author nor the publisher can be held liable for any damage associated with the use of this manual.

Other product, brand and company names mentioned in this document may be the trademarks of their respective owners. Compliance with all applicable copyright laws is the responsibility of the user of this document.

---

**Detailed safety information:****⚠ NOTE**

- Read these instructions. Keep these instructions.
- Heed all warnings. Follow all instructions.
- Do not use this device near water.
- Only clean the device with a dry cloth.
- Do not block any ventilation openings.
- Do not place the device near heat sources such as radiators, stoves or other devices that generate heat.
- Pay attention to the volume! Hearing at a high-volume level can permanently damage your hearing.
- Contact qualified service personnel for all repair / maintenance work. Do not open the device or the housing yourself. Maintenance is required if the device has been damaged in any way, e.g., if the power cord or plug is damaged, liquid has been spilled or objects have fallen into the device, the device has been exposed to rain or moisture, is not working properly or has been dropped.

**Function:**

The headphones can be connected to every playing device (e.g., CD-players) as well as instrument (e.g., E-drumset, keyboard or piano). It is only important to note which jack plug is required for the used device: the 3.5 mm jack or the 6.3 mm jack of the adapter. (Adapter is included in delivery)

**⚠ WARNING** Pay attention to the volume! Hearing at a high-volume level can permanently damage your hearing.

## Maintenance

Your device does not require any special maintenance. However, in the event of a malfunction, contact an approved service center or the manufacturer

## Cleaning

Use a lint-free and only slightly damp cloth for cleaning.

## Technical specifications:

**System:** dynamic headphones

**Impedance:** 32 Ohm

**Speakers:** Stereo

**Frequency range:** 20-20000 Hz

**Sensitivity:** 110dB SPL

### WEEE declaration (Waste of Electrical and Electronic Equipment)

Your product has been developed and manufactured using high quality materials and components that are recyclable and reusable. The symbol means that your product must be disposed of separately from household waste at the end of its service life.

Dispose of this device at your local collection or recycling centre, please help protect the environment we all live in.

All technical data and appearances are subject to change without notice. All information was correct at the time of printing. Musikhaus Kirstein GmbH assumes no liability for the correctness or completeness of the descriptions, photos or statements contained in this manual. Printed colours and specifications may differ slightly from the product. Musikhaus Kirstein GmbH products are only sold through authorized dealers. Distributors and dealers are not representatives of Musikhaus Kirstein GmbH and are not authorized to bind Musikhaus Kirstein GmbH legally in any way.

This manual is protected by copyright. Reproduction of these operating instructions, in whole or in part, is only permitted with the approval of Musikhaus Kirstein GmbH. The same applies to the duplication or copying of images, even in modified form.

© 2024

 **KIRSTEIN.de**

**Musikhaus Kirstein GmbH**

**Bernbeurener Str. 11**

**D-86956 Schongau**

**info@kirstein.de**

**www.kirstein.de**

**Phone: +49(0)8861 / 90 94 94 -0**





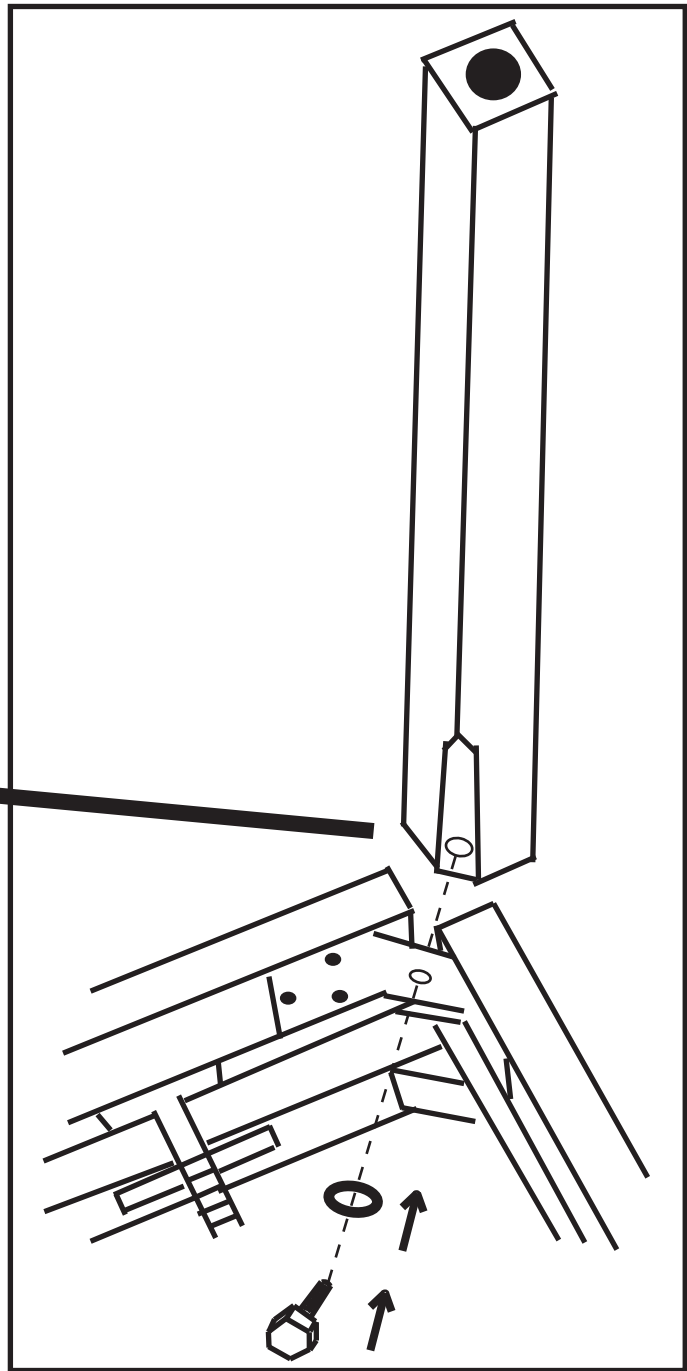
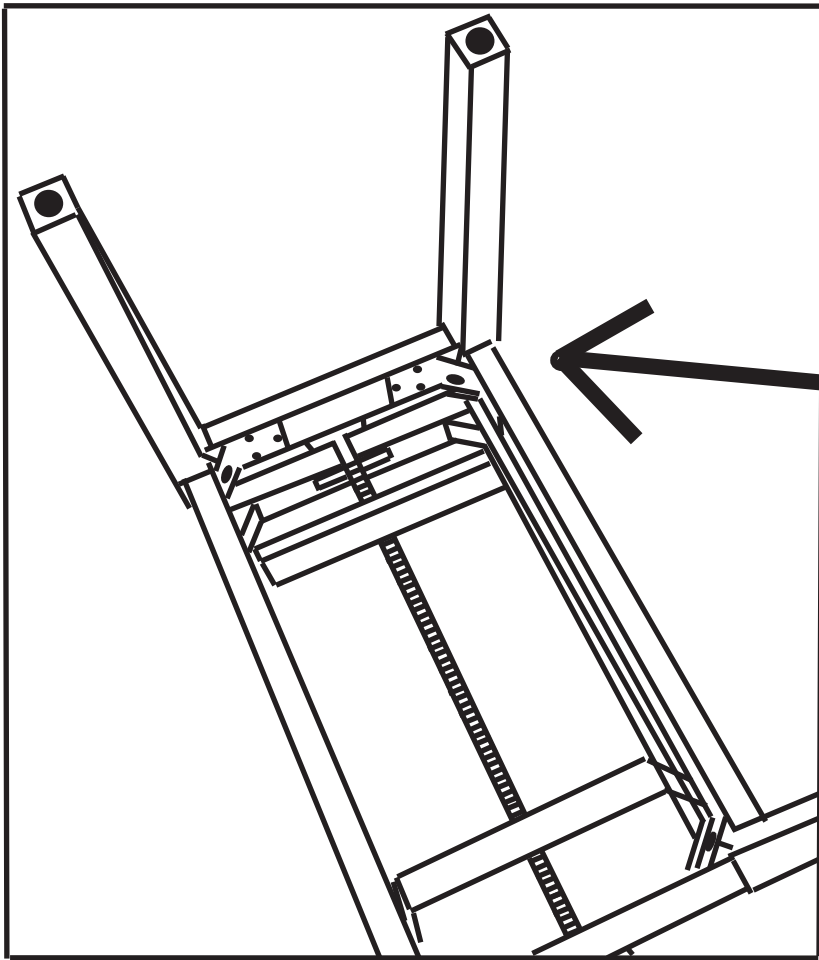

**VORSICHTSMASSNAHMEN (BITTE SORGFÄLTIG DURCHLESEN)** Kinder sollten beaufsichtigt werden, um sicherzustellen, dass sie dieses Produkt nicht als Spielzeug verwenden. Lassen Sie Kinder niemals unbeaufsichtigt mit dem Verpackungsmaterial spielen. **Warnhinweise:** Stellen Sie das Produkt stets auf eine geeignete Oberfläche ab, um ein Wackeln oder Umfallen zu verhindern. **Vorsichtsmaßnahmen:** Um Schäden am Produkt zu vermeiden, stellen Sie es nicht an Plätze mit hohen Temperaturen oder viel Staub, stellen Sie es nicht direkt neben eine Klimaanlage und vermeiden Sie direkte Sonneneinstrahlung. Wenden Sie im Umgang mit dem Produkt keinerlei Gewalt an und stellen Sie keine zu schweren Gegenstände darauf. **Ort:** Setzen Sie das Produkt nicht den folgenden Bedingungen aus, um Verformungen, Verfärbungen oder größere Schäden zu vermeiden: Direktes Sonnenlicht, extreme Temperatur oder Luftfeuchtigkeit, übermäßig staubiger oder schmutziger Ort, starke Vibrationen oder Stöße. **Reinigung:** Reinigen Sie das Produkt nur mit einem weichen, trockenen Tuch. Verwenden Sie keine Farbverdünner, Lösungsmittel, Reinigungsflüssigkeiten oder chemisch imprägnierte Wischtücher. **Handhabung:** Üben Sie keine übermäßige Kraft auf Bedienelemente wie z.B. Schalter, Knöpfe aus. Technische Änderungen und Änderungen im Erscheinungsbild sind vorbehalten. Alle Angaben entsprechen dem Stand bei Drucklegung. Für die Richtigkeit und Vollständigkeit der enthaltenen Beschreibungen, Abbildungen und Angaben übernimmt Musikhaus Kirstein GmbH keinerlei Gewähr. Abgebildete Farben und Spezifikationen können geringfügig vom Produkt abweichen. Musikhaus Kirstein GmbH - Produkte sind nur über autorisierte Händler erhältlich. Distributoren und Händler sind keine Handlungsbevollmächtigten von Musikhaus Kirstein GmbH und haben keinerlei Befugnis, die Musikhaus Kirstein GmbH in irgendeiner Weise, sei es ausdrücklich oder durch schlüssiges Handeln, rechtlich zu binden. Diese Bedienungsanleitung ist urheberrechtlich geschützt. Jede Vervielfältigung, bzw. jeder Nachdruck, auch auszugsweise, und jede Wiedergabe der Abbildungen, auch in verändertem Zustand, ist nur mit schriftlicher Zustimmung der Firma Musikhaus Kirstein GmbH gestattet.

**PRECAUTIONS (PLEASE READ CAREFULLY)** Children should be supervised to ensure that they do not use this product as a toy. Never let children play with the packaging material unsupervised. **Warning:** Always place the product on a suitable surface to prevent it from wobbling or falling over. **Precautions:** To avoid damage to the product, do not place it in places with high temperatures or a lot of dust, do not place it directly next to an air conditioner and avoid direct sunlight. Do not use force when handling the product and do not place objects that are too heavy on it. **Location:** Do not expose the product to the following conditions to avoid warping, discoloration, or major damage: direct sunlight, extreme temperature or humidity, excessively dusty or dirty location, strong vibration or shock. **Cleaning:** Only clean the product with a soft, dry cloth. Do not use paint thinners, solvents, cleaning fluids, or chemically impregnated wipes. **Handling:** Do not exert excessive force on controls such as switches, buttons. Technical changes and changes in appearance are reserved. All information corresponds to the status at the time of printing. Musikhaus Kirstein GmbH assumes no liability for the correctness and completeness of the descriptions, illustrations and information contained. Shown colors and specifications may differ slightly from the product. Musikhaus Kirstein GmbH - Products are only available through authorized dealers. Distributors and dealers are not authorized representatives of Musikhaus Kirstein GmbH and have no authority to bind Musikhaus Kirstein GmbH legally in any way, be it expressly or through coherent action. This manual is protected by copyright. Any duplication or reprint, even in part, and any reproduction of the images, even in a modified state, is only permitted with the written consent of Musikhaus Kirstein GmbH.

# STEINMAYER

DP 321

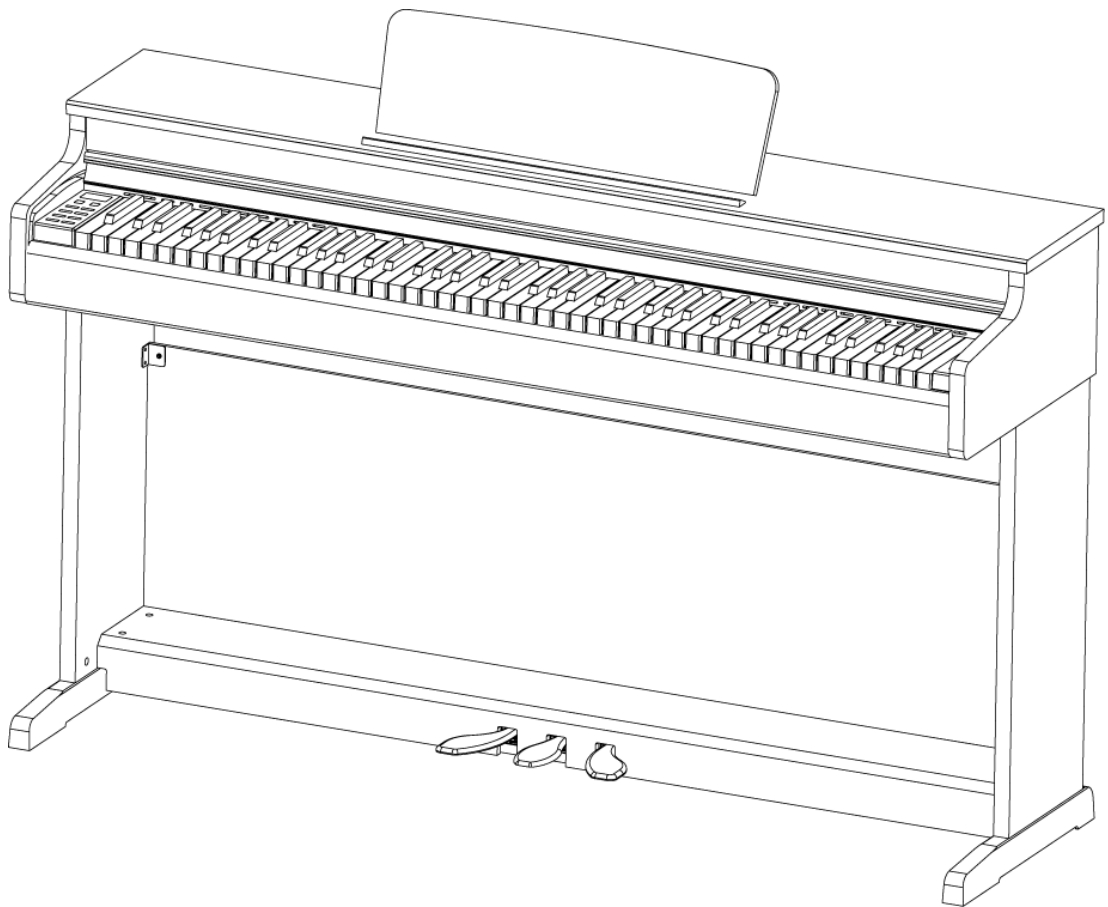

Owner's Manual

Version: 11/2019

© 2019

This manual is protected by copyright. Any copying or reprint, even in excerpts, is only allowed with consent of Musikhaus Kirstein GmbH. The same applies to reproduction or copying of images, even in altered form.

## Contents

<b>Zusammenbau .....</b>	<b>1</b>
Assembly of the pedal bar and side panels .....	2
Attach the Back .....	2
Fitting the piano console .....	3
Connect the pedal cable and power cord .....	3
<b>Basic operation.....</b>	<b>4</b>
Power switch.....	4
Auto Power Off (APO) .....	4
<b>Headphone jacks .....</b>	<b>4</b>
<b>Connections.....</b>	<b>5</b>
<b>Pedals.....</b>	<b>6</b>
Connecting the pedal cable .....	6
How to operate the pedals .....	6
<b>Operating unit .....</b>	<b>7</b>
<b>Bedienung Operation .....</b>	<b>8</b>
Adjusting the volume .....	8
Choosing a Tone (Voice).....	8
Voice-List .....	8
Piano Mode.....	9
Dual .....	9
Layer.....	9
Split.....	9
Move the split point .....	10

# STEINMAYER

---

Twin Piano .....	10
<b>Metronome .....</b>	<b>10</b>
Start / Stop .....	10
Metronome Tempo .....	11
Further Metronome Parameters .....	11
<b>“Piano Assist” Function.....</b>	<b>11</b>
To start Piano Assist .....	11
Selection of the accompaniment rhythm.....	11
List of available drum rhythms.....	12
Piano Assist Tempo .....	12
Piano Player.....	12
Select Accompanying Pattern .....	12
To start the Piano Player Playing Help .....	13
Chord specification for the Piano Player.....	13
Select the Method .....	14
To Move the Split Point for the Chord Input.....	15
<b>“Record” Function.....</b>	<b>15</b>
Recording.....	15
Playback .....	16
To Delete Recordings.....	16
Selection of a Memory Bank.....	17
<b>Music Database.....</b>	<b>17</b>
Selection of a Music Folder .....	17
To Select the Track for Playback.....	17
Adjusting the Tempo .....	18
Further settings .....	18
<b>Bluetooth.....</b>	<b>18</b>
Bluetooth Audio.....	18
Bluetooth-MIDI .....	19

<b>BrainCare .....</b>	<b>19</b>
BrainCare Liste .....	21
<b>Function-menu.....</b>	<b>21</b>
F01 Tune.....	22
F02 Transpose .....	22
F03 Touch.....	22
F04 Touch fixed Volume .....	23
F05 Metronome Time-Signature.....	23
F06 Metronome Volume .....	23
F07 Main Voice Volume .....	23
F08 Layer Voice Volume .....	23
F09 Split Voice Volume .....	23
F10 Split point .....	23
F11 Reverb Type .....	24
F12 Reverb Volume .....	24
F13 Effect Type.....	24
F14 Effect Volume.....	24
F15 String Resonance.....	24
F16 Damper Resonance .....	24
F17 Corpus Resonance .....	25
F18 Half-pedal.....	25
F19 Piano Assist Mode .....	25
F20 Piano Assist Multi-finger.....	25
F21 Piano Assist Volume .....	25
F22 Music Playback Mode .....	25
F23 Music Playback .....	26
F24 Transpose Music Playback .....	26
F25 Bluetooth.....	26
F26 Bluetooth Volume.....	26

# STEINMAYER

---

F27 AUX-In Volume .....	26
F28 MIDI Local.....	26
F29 Auto Power Off.....	26
rSt Reset.....	26
<b>MIDI Chart.....</b>	<b>27</b>
<b>GM-Voice.....</b>	<b>28</b>
<b>Percussion .....</b>	<b>29</b>
<b>Trouble Shooting.....</b>	<b>30</b>
<b>Product Specifications .....</b>	<b>31</b>
<b>WEEE Declaration.....</b>	<b>32</b>

Thank you for choosing this product.

To ensure that you are fully satisfied with this product, carefully read and understand this manual before using this instrument. Keep this manual in a safe place. The operating instructions must be passed on to all subsequent users.



Observe operating instructions!



The WARNING signal word identifies hazards that, without precautions, could result in serious injury.



The signal word NOTE indicates general precautions that should be observed when handling the product.



Images and screen images in this manual may differ slightly from the actual product's appearance, as long as it does not adversely affect the technical characteristics and safety of the product.



All personal phrasing in this manual should be considered gender neutral.

These operating instructions apply to responsible persons and users who have been supervised by a person responsible for their safety or instructed in the operation of the device and who have proven to be able to handle the device.



**Children should be supervised to ensure that they do not use this device as a toy.  
Never allow children to play unattended with the packaging material.**



**Danger of property damage! We are not liable for accidents that occur as a result of non-observance of the safety instructions or due to incorrect handling.**

All information in this manual has been checked to the best of our knowledge and belief. However, neither author nor publisher can be held liable for any damage related to the use of this manual.

Other product, brand and company names mentioned herein may be the trademarks of their respective owners. Compliance with all applicable copyright laws is the responsibility of the user of this document.

 **WARNING**

**Caution**

Please observe the following basic information in order not to endanger yourself or others and to avoid damage to external devices.

 **NOTE**

**Warning**

Do not disassemble the instrument and do not modify it. This could result in electric shock. Entrust a specialist workshop with any necessary service and maintenance or contact your dealer.

If you notice that the power cord is showing signs of wear, the unit shows malfunctions, burns, smells or smokes, unplug the power cord immediately and have a technician repair it.

Before you clean the instrument, you should disconnect it from the mains power. Always place the instrument on a level, stable surface to ensure a secure footing.

Do not use the instrument in a damp or wet environment.

Do not place vessels that are filled with liquids on the instrument, such as vases, glasses or bottles.

Do not place small objects on it that could slip in, such as Hairpins, sewing needles or coins.

Do not place burning candles on the instrument.

 **NOTE**

**Precautions**

To avoid damage to the instrument, do not place it in places with high temperatures or dust, do not place it next to an air conditioner and avoid direct sunlight.

Do not place the instrument near other electrical equipment to avoid interference.

Do not use force when handling the instrument or place heavy objects on it.

Disconnect the instrument from the power if you are not going to use it for a long time. To disconnect the device from the mains, pull the plug, not the cable. Please handle the power cable with care. It should not be near radiators, you should not place heavy objects on it and move it so that people can not step on it or fall over it.

Please note that continuous high volume can permanently damage your hearing.

Adjust the volume carefully.

 **WARNING**

**Power adapter**

Please connect the supplied power adapter to a power outlet with the correct voltage. Do not connect it to mains voltages other than those for which the instrument is intended. Unplug the power cord if you are not going to use the product for a long time or if there is upcoming a thunderstorm.



## Zusammenbau

Please unpack the instrument carefully and make sure all components listed below are in perfect condition.

If any items are missing or damaged, please contact the manufacturer.

**Piano console**

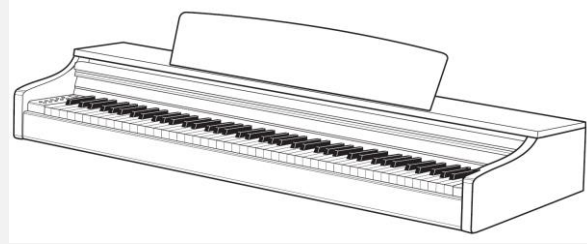

**Operating manual (possibly as download)**

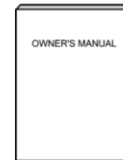

**Left / Right foot (a, b)**

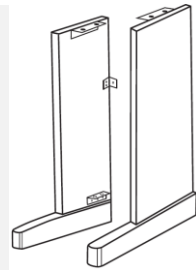

**Pedal unit (c)**

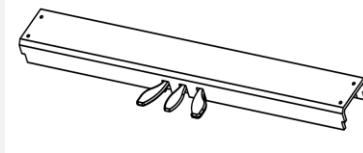

**Back (d)**

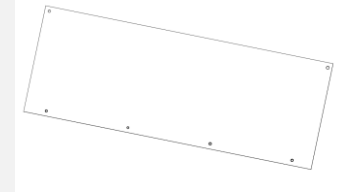

**Screws pedal box**

**(e) 4 pieces M6 x 25**



**Screws for the Back**

**(f) 4 pieces M3,5 x 25**  
**(g) pieces M4 x 13**

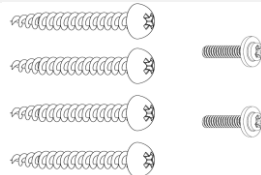

**Screws for the console**

**(h) 4 pieces M6 x 15**

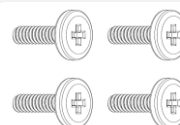

**Power adapter**



► It may be useful to keep the packaging materials in case the instrument needs to be transported to a faraway place.

## Assembly of the pedal bar and side panels

Attach the pedal bar (c) between the two side panels (a, b) using the screws (e)

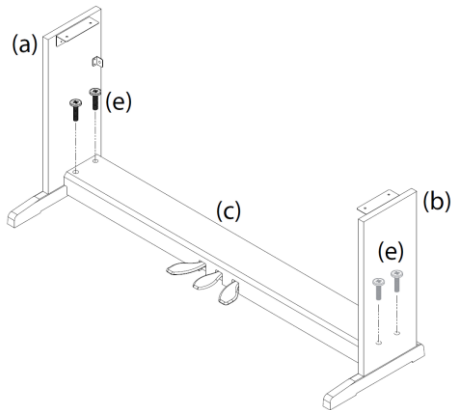

Unscrew the spacer screw under the pedal unit until it makes contact with the ground and the pedal unit can be supported against the pedal pressure towards the ground.

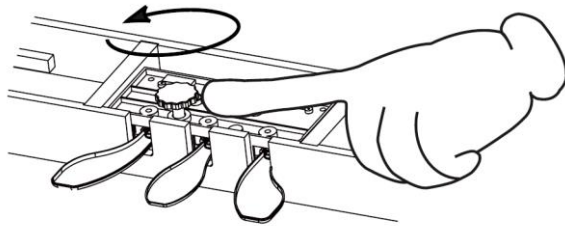

## Attach the Back

Attach the Back to the base from the rear and attach it to the side panels using the screws (g).

Make sure the base is properly aligned and secure the Back to the pedal bar using the screws (f).

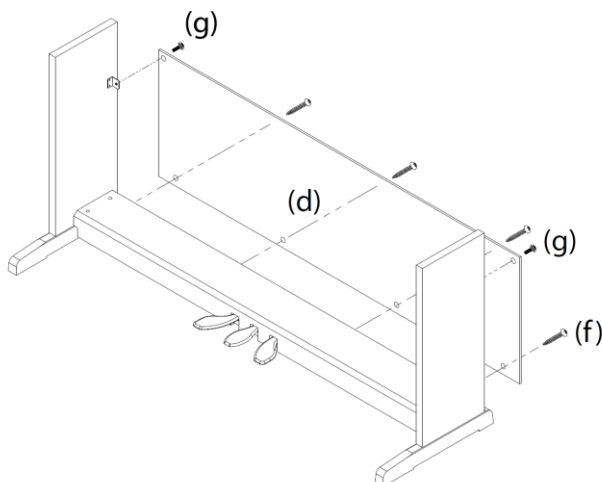

## Fitting the piano console

Carefully place the piano console on the base. Pay attention to your fingers. Connect the two components using the screws (h)

Set up the music stand and hold it at the desired angle with the metal base

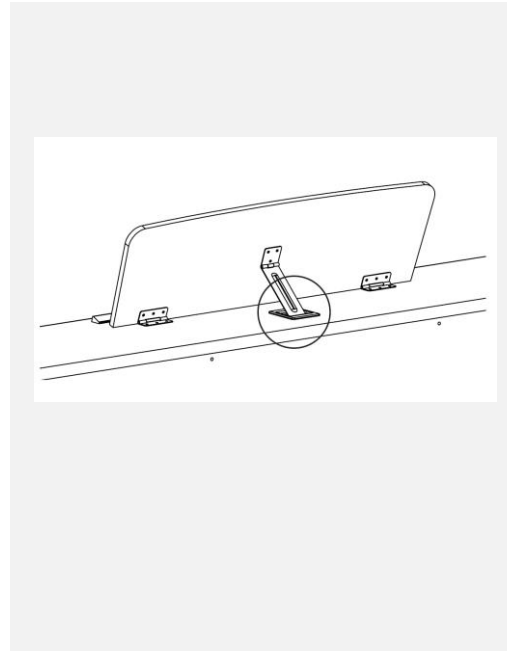
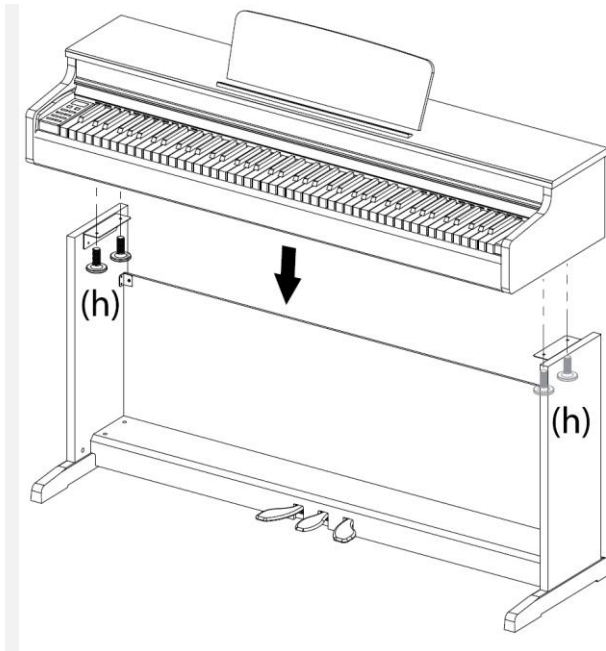

## Connect the pedal cable and power cord

Connect the pedal cable (this is already placed on the underside of the pedal bar) with the matching connection on the underside of the piano console.

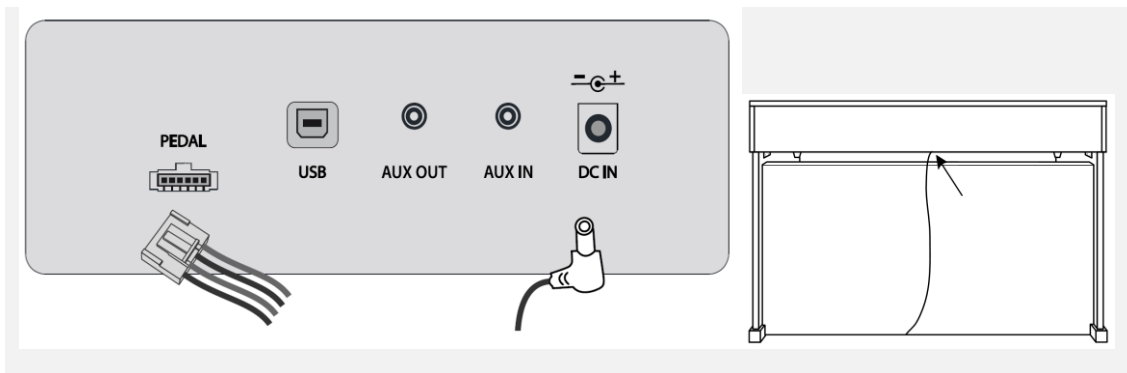

## Basic operation

### Power switch

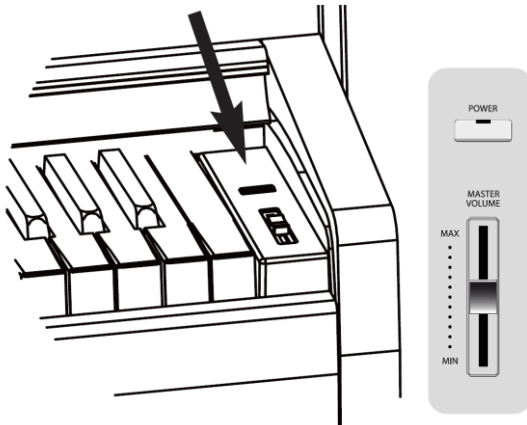

Insert the jack plug of the power supply unit into the socket at the bottom of the console and then plug the power plug into the socket.

Now press the power button to turn on the instrument.

► When switching on for the first time, "German G.Piano" is selected as "Voice".

► Adjust the desired volume with the MASTER VOLUME control.

To turn off the instrument, press and hold the power button. All settings made will be reset to the default value when restarting. Recordings are saved in the memory.

### Auto Power Off (APO)

This instrument automatically shuts off, if it is not used for 30 minutes. This setting can be changed via function-menu.

## Headphone jacks

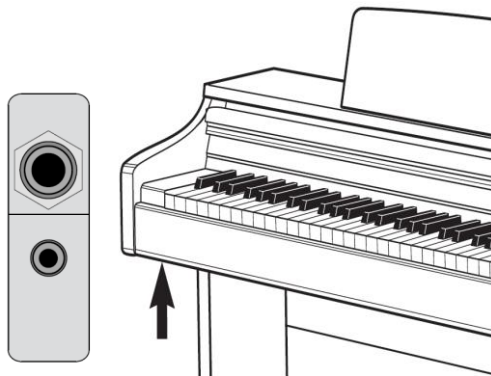

There are two headphone jacks in the connection panel at the bottom left of the piano console

► The loudspeakers of the instrument are automatically deactivated when a headphone is connected

► To allow the connection of both commercially available headphone plug, the instrument has a 6.35 mm and a 3.5 mm headphone jack.

► Both headset connections can be used simultaneously. Thus, two players can practice together through headphones.

## Connections

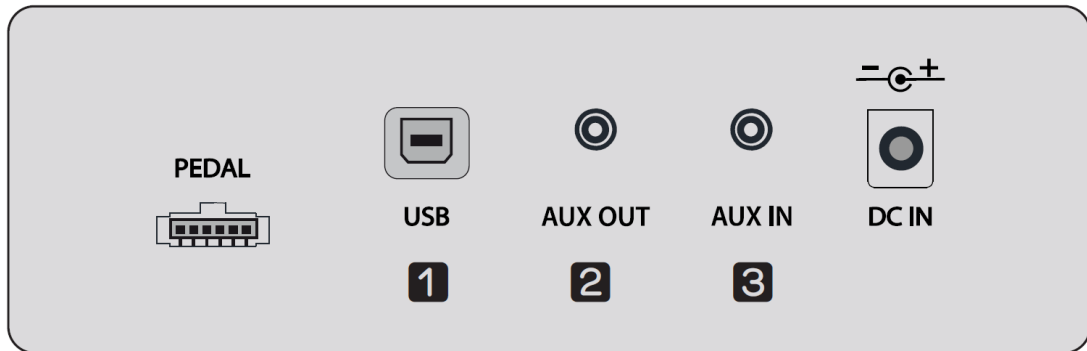

Connection panel at the bottom of the piano console

### **1** USB to HOST - (USB – B)

The USB-to-HOST jack connects to the computer to transmit MIDI or audio data. The connection is made via a USB A to B cable (not included).

To use the piano as a MIDI input device, start MIDI-capable software (not included) on your computer and select the piano as a MIDI device within the application.

To use the piano as an audio source, select the instrument in the audio settings of the computer as the audio device.

**⚠ NOTE**: The instrument uses USB 2.0. It is recommended not to exceed a cable length of 1.2m. The instrument supports Windows XP or higher, Mac OS X and iOS 4.0 and higher. Compatibility with Android Devices may be limited depending on the manufacturer and version. No further drivers are needed. After connecting, to avoid malfunction, wait a few seconds before using the instrument.

### **2** Aux Out – Stereo 3.5mm

The Aux-Out jack can be used to connect external amplifiers or recorders. The music signals sent out via this jack can be played back via an external amplifier or recorded by a recording device. It is recommended to turn off both devices before making a cable connection. Initially, to avoid damage, set the volume / sensitivity of both devices to a low level.

### **3** Aux In – Stereo 3.5mm

The Aux-in jack can be used to connect external audio devices such as Mp3 players. The incoming music signals through this jack are played through the loudspeakers of the piano. It is recommended to turn off both devices before making a cable connection. Initially, to avoid damage, set the volume of both devices to a low level.

## Pedals

The instrument has three pedals. These simulate the pedals of a real concert piano.

### Connecting the pedal cable

Disconnect the pedal cable which is fixed under the pedal box and connect it to the corresponding socket on the underside of the piano console.

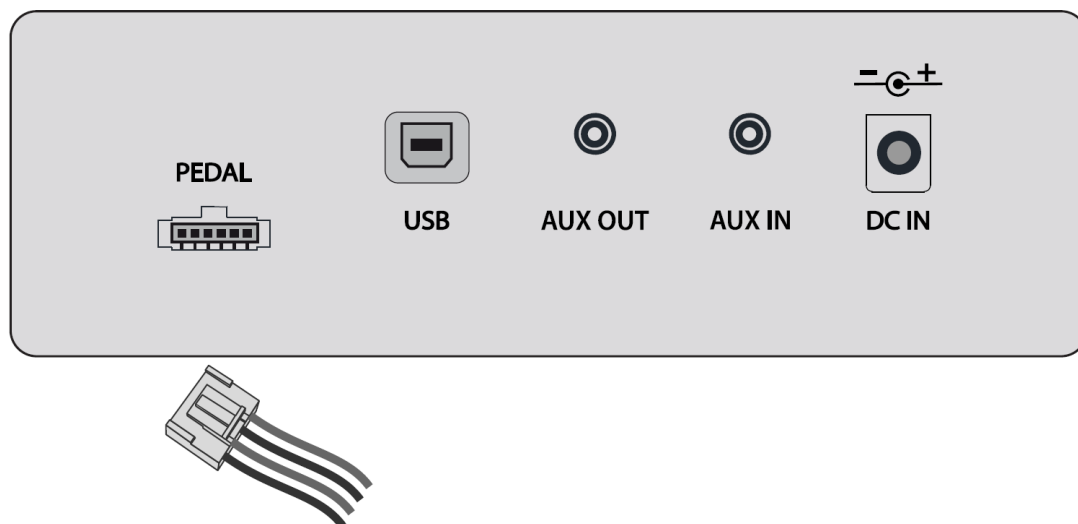

### How to operate the pedals

#### 1 Sustain Pedal (right pedal)

This pedal has the same function as the sustain pedal of an acoustic piano. Notes played while the pedal is pressed continue to sound when the key on the keyboard is released. This pedal also supports the half-pedal-function, which simulates the sound of a piano string slightly touched by the damper while the pedal is lightly pressed.

#### 2 Sostenuto Pedal (middle pedal)

This pedal has the same function as the Sostenuto-Pedal of a concert piano. It behaves similar to the sustain pedal, but only the sounds are retained which are triggered simultaneously with the pedal.

#### 3 Soft Pedal (left pedal)

This pedal has the same function as the Soft Pedal of an acoustic piano. Pressing this pedal softens and thins the sound a bit.

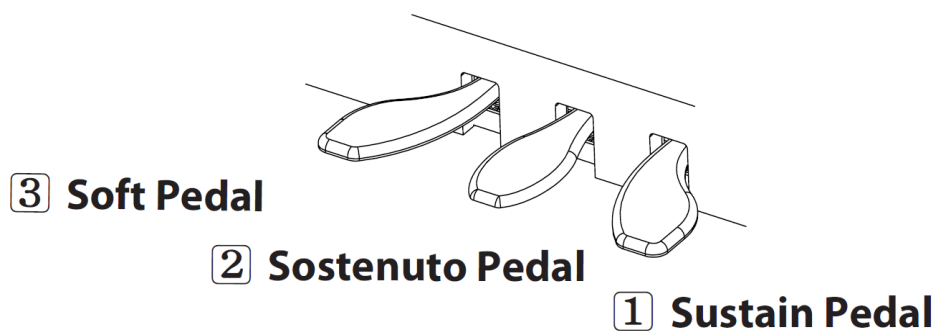

## Operating unit

<p>The diagram shows the control panel of the operating unit. At the top is a rectangular LCD screen labeled 'a'. Below it are two arrow keys labeled 'b' (down) and 'c' (up), with the word 'DATA' between them. Below these are two buttons labeled 'd' (PIANO) and 'e' (DUAL). Below those are two buttons labeled 'f' (REC/DEMO) and 'g' (ENTER). Below those are two buttons labeled 'h' (TRACK 1) and 'i' (TRACK 2). At the bottom are two buttons labeled 'j' (SETUP) and 'k' (PIANO ASSIST). The BrainCare logo is at the very bottom.</p>	<p>a LCD screen</p> <p>b DATA move down</p> <p>c DATA move up</p> <p>d PIANO</p> <p>e DUAL</p> <p>f REC / DEMO</p> <p>g Play-Stop / ENTER</p> <p>h TRACK 1</p> <p>i TRACK 2</p> <p>j SETUP</p> <p>k PIANO / ASSIST</p>	<p>page 9</p> <p>page 9</p> <p>page 15, 17</p> <p>page 15</p> <p>page 15</p> <p>page 21</p> <p>page 10, 11</p>
--	--	--

## Bedienung Operation

### Adjusting the volume

To adjust the overall volume, use the volume slider

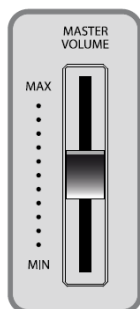

### Choosing a Tone (Voice)

Select the desired tone with the arrow keys DATA ▼▲

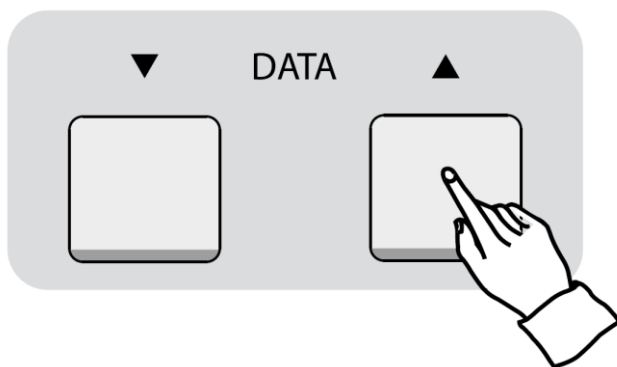

### Voice-List

LED	Voice	LED	Voice	LED	Voice	LED	Voice
G.P1	Grand Piano1	P.Or	Pipe Organ	vcL	Vocal	CLA	Clarinet
G,P2	Grand Piano2	E.O1	Electr Organ1	vln	Violin	br1	Brass Sect1
G.P3	Grand Piano3	E.O2	Electr Organ2	HAP	Harp	br2	Brass Sect2
G.P4	Grand Piano4	Acid	Accordion	Gt1	Nylon Guitar	S.br	Synth Brass
Ht.P	Honky Tonk	St1	Sym. Strings	Gt2	Drive Guitar	A.SP	Alto Sax
E.P1	Electr. Piano1	St2	Synth Strings	A.bS	Acoustic Git	t.SP	Tenor Sax
E.P2	Electr. Piano2	St3	Slow Strings	E.bS	E-Bass	Sqr	Square
HSC	Harpicord	P.St	Pizz Strings	FLt	Flute	dru	Drum
Vbr	Vibraphone	Chr	Choir Aahs	Obo	Oboe	S.EF	Sound Effects



## Piano Mode

Press the PIANO button to enter Piano mode.

The instrument changes to the tone Grand Piano1 (G.P1).

Press DATA ▼▲ again to exit this mode.



The dual function is not available in Piano mode.

## Dual

Press the DUAL button to enter the Dual Mode. In this mode, you can combine multiple timbres in different ways. Pressing the DUAL button repeatedly will enter the different operating modes: Layer, Split and TwinPiano. To exit this function, press the DUAL button again.

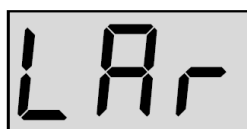

Layer

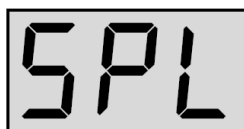

Split



Twin Piano

## Layer

Here two tones per key are played simultaneously.

First select the desired main voice (Main Voice).

Now press the DUAL button. The display shows LAr. Now select the desired second tone (Layer Voice) with the arrow keys DATA ▼▲.

The volume levels of both voices can be adjusted individually. See function-menu.

Press the DUAL button three times to deactivate the mode.

## Split

Here, the keyboard divides into two areas with different timbres. First, select the desired main voice for the right keyboard half.

Now press the DUAL button two times. The display shows SPL. Now select the desired second tone (Split-Voice) with the arrow keys DATA ▼▲.

The volume levels of both voices can be adjusted individually. See function-menu.

Press the DUAL button two times to deactivate the mode.

## Move the split point

The split point defines the boundary between the left and right half of the keyboard. The split point can be chosen individually. See function-menu. The default value for the split point is F # 3 (the third Fis from the left).

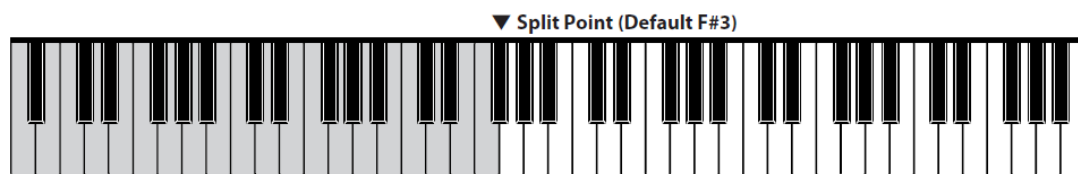

## Twin Piano

This function divides the keyboard into two equal parts. Now two players can play in the same pitch at the same time.

The operation of the pedals is adapted to the split keyboard. The left pedal controls the sustain effect of the left keyboard half and the right pedal controls the sustain effect of the right keyboard half.

First, select the desired main voice for the right keyboard half. Now press the DUAL button several times. The display shows tn. The keyboard is now shared at Eb4.



Press the DUAL button again to deactivate the TWIN Piano mode.

## Metronome

### Start / Stop

Press the PIANO ASSIST button to start the metronome.

Press the PIANO ASSIST button again to stop the metronome.

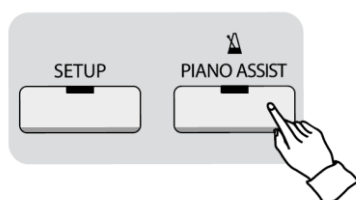

## Metronome Tempo

Use the DATA ▼▲ keys to change the metronome tempo. Hold the DATA ▼▲ keys to quickly change the tempo. Press both DATA ▼▲ keys simultaneously to get to the default value (120).



**Default Tempo**

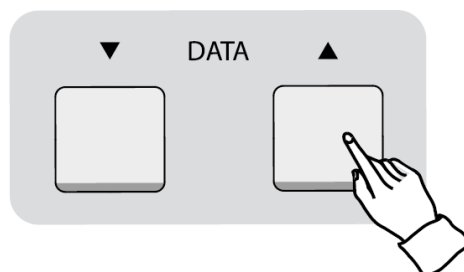

## Further Metronome Parameters

The metronome volume and the tempo (3/4, 4/4, etc.) can be adjusted as further parameters. See function-menu.

## “Piano Assist” Function

In the Piano Assist function two different assistants can be selected. In Drum Player mode, you can be accompanied by a drum rhythm. In Piano Player mode, the instrument plays complicated left-hand chord patterns on its own, making it easier to play challenging piano pieces.

### To start Piano Assist

To start Piano Assist, press and hold the PIANO ASSIST button for about 2-3 seconds.

The display shows r01 and the piano is in the mode for the selection of the accompaniment rhythm.

### Selection of the accompaniment rhythm

Use the DATA ▼▲ keys to select the desired pattern of drum accompaniment.

By holding the DATA ▼▲ keys you can scroll faster in the selection list. Press both DATA ▼▲ keys simultaneously to get to the standard rhythm (r01).



**NOTE**

The sounds of the Piano Assist function cannot be recorded in the recording function.

## List of available drum rhythms

LED	Rhythm	LED	Rhythm	LED	Rhythm	LED	Rhythm	LED	Rhythm
r01	Pop 1	r09	Rhumba	r17	March	P05	Polka	P13	Skate Waltz
r02	Pop 2	r10	Salsa	r18	Polka	P06	March	P14	Jazz Waltz
r03	Ballad	r11	Tango	r19	Country	P07	Blues1	P15	Beguine
r04	Rock	r12	Swing	r20	Chacha	P08	Blues2	P16	Twist
r05	Shuffle	r13	Jazz	P01	Arpeggio 4/4	P09	RocknRoll	P17	Jive
r06	Slow Rock	r14	Bossanova	P02	Arpeggio 3/4	P10	Swing	P18	Obladi
r07	Funk	r15	Waltz 1	P03	Ballad	P11	Boogie	P19	Dixieland
r08	Latin	r16	Waltz 2	P04	Slow Rock	P12	Waltz	P20	Country

Press the ENTER / ►/■ button to start the drum accompaniment. Press the ENTER / ►/■ button again to stop the drum accompaniment.



**NOTE**

The volume of the Piano Assist can be adjusted in the function-menu.

### Piano Assist Tempo

Use the DATA ▼▲ keys to change the metronome tempo. The metronome tempo will change when the display has switched from the rhythm display back to the tempo display (e.g., 120). By holding the DATA ▼▲ keys, the tempo value can be changed quickly. Press both DATA ▼▲ keys simultaneously to get to the default value of the respective rhythm.

### Piano Player

In the Piano Player mode, you can choose between numerous accompanying characters, which facilitate the play of the left hand.

The operation of the Piano Player mode is analogous to the drum player.



**NOTE**

The piano player mode must be activated in the function-menu. See function-menu.

To start Piano Assist, press and hold the PIANO ASSIST button for about 2-3 seconds.

The display shows p01 and the piano is in the selection mode for the Piano Player.

### Select Accompanying Pattern

Use the DATA ▼▲ keys to select the desired pattern of the Piano Player playing help.

## To start the Piano Player Playing Help

The piano player starts as soon as you specify a chord in the left part of the keyboard. The instrument now plays independently the associated chord break of the selected accompanying figure. Press the ENTER / ►/■ button to stop the Piano Player. Press the PIANO ASSIST button to exit this mode.

## Chord specification for the Piano Player

In Piano Player mode, it is necessary to specify the chord of the desired accompaniment character.

For this purpose, two methods can be used with this instrument:

### Single Finger method

With the Single Finger method, chords can be specified with 1-3 fingers. Here, the root of a chord is enough to define a major triad. The keynote and the nearest left black key lead to a minor triad. The root note and the nearest left white key give a dominant seventh chord and the root note and the nearest left white and black keys a minor seventh chord.

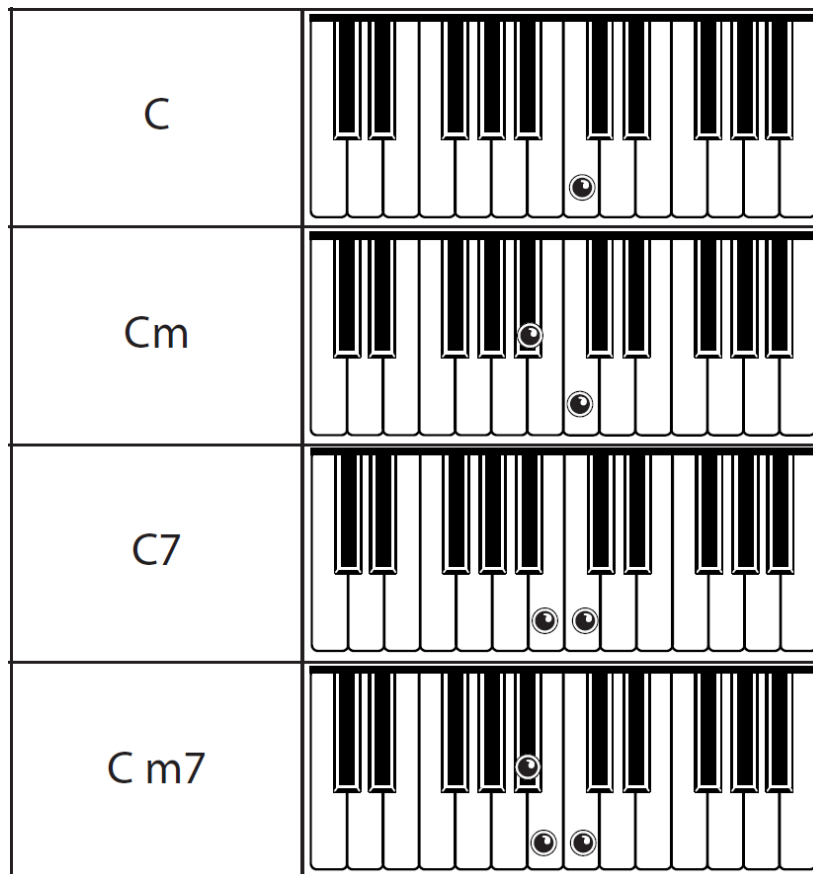

## Fingered method

With the fingered method, it is possible to specify a chord by all chord tones involved. The advanced player can use this method to reproduce more complicated chords.



Major: C

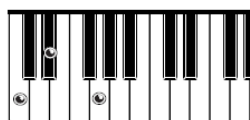

Minor: Cm

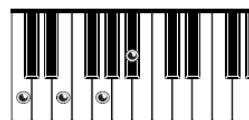

Dominant 7: C7

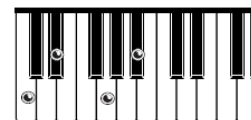

Minor 7th: Cm7

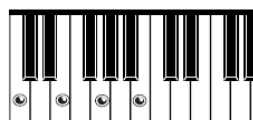

Major 7th: CM7

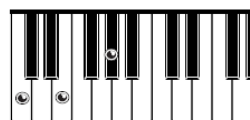

Augmented: Caug

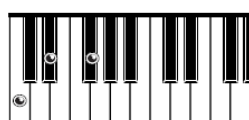

Diminished: Cdim

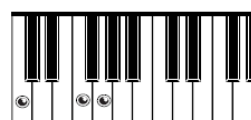

Suspended 4: Csus4

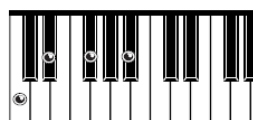

Minor 7b5: Cm7-5

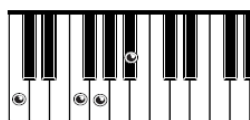

Dominant Sus4: C7sus4

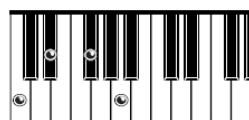

Dominant Diminished: C7dim

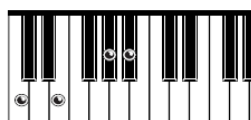

Dominant Augmented: C7aug



Minor Major 7th: CmM7

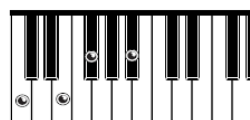

Dominant 7th5: C7-5

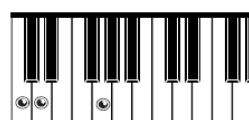

Suspended 2: Csus2

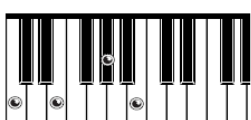

Major 7th Augmented: CM7aug

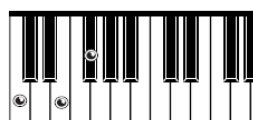

5th: C5

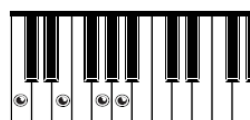

6th: C6

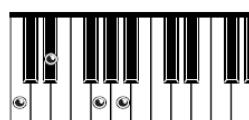

Minor 6th: Cm6

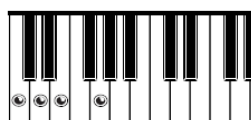

Add 9th : Cadd9



Minor Add 9th: Cmadd9



Minor Major 7th5: CmM7-5

## Select the Method

By default, the piano recognizes both input methods. If you only want to use the Fingered method, you can set this in the function-menu. See function-menu.

## To Move the Split Point for the Chord Input

The split point defines the limit up to which tone of the left hand chords for the piano player can be specified. The split point can be chosen individually. See function-menu. The default value for the split point in Piano Assist mode is Gb3.

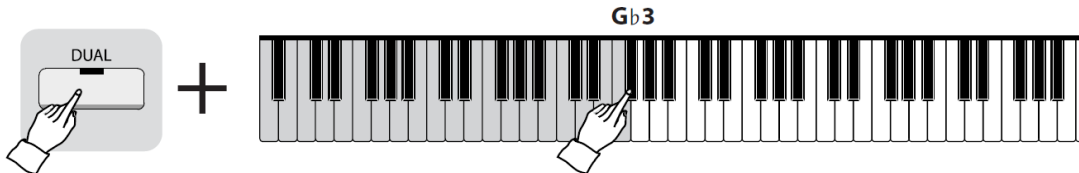

## “Record” Function

### Recording

Press the REC / DEMO button to enter the recording mode.

The TRACK1 button flashes and indicates that your piano is ready for recording.



Press the ENTER / ►/■ button or play the keyboard to start recording.

During recording, the REC / DEMO button flashes.

To stop recording, press the ENTER / ►/■ button. The TRACK1 button now lights permanently to signal stored music data.

To play the recorded track, press the ENTER / ►/■ button again.

To start another recording on TRACK2, press TRACK2 in the recording mode. The TRACK2 button flashes and indicates that your piano is ready for recording.

If a recording is already stored on the TRACK1 storage location, it will be played back simultaneously when recording to TRACK2. If you do not want to hear TRACK1, you can mute it by pressing TRACK1 before recording (TRACK1 backlight goes off).

Press REC / DEMO again to exit the recording mode.

 **NOTE** If no key is pressed for a long time during recording, recording will stop automatically.

The recording capacity per track is 4500 notes. If this number is exceeded, the recording stops automatically.

If you want to use the metronome while recording, start the metronome before recording. The metronome will not be recorded.

A track occupied by a recording cannot be dubbed. If you want to replace this track, first delete the current recording.

The piano has an internal memory. The recorded tracks are not lost when switching off.

## **Playback**

To play saved music data, select the desired track (Track1, Track2 or Track1 + Track2). To select a track, press the respective TRACK button. If music data is stored in this memory location, the button lights up and indicate that the piano is ready to play. To mute a track for playback, press the desired TRACK button again. The button stops lighting and indicates that this memory do not have recording or is muted for playback.

During playback, the ENTER / ►/■ button flashes.

 **NOTE** Track selection cannot be changed while playback is in progress.

## **To Delete Recordings**

To delete recordings, press and hold the desired TRACK button.



## Selection of a Memory Bank

The piano has 3 memory banks (rE1-rE3) for 2 tracks each. To select a memory bank, in the recording mode, while the display is showing rE1, use the DATA ▼▲ buttons to switch to rE2 or rE3.

## Music Database

The instrument contains various music data which can be used for practicing or simply for listening.

Press and hold the REC / DEMO button to enter the corresponding selection-menu.

The REC / DEMO button will light up and the display will show CLS.

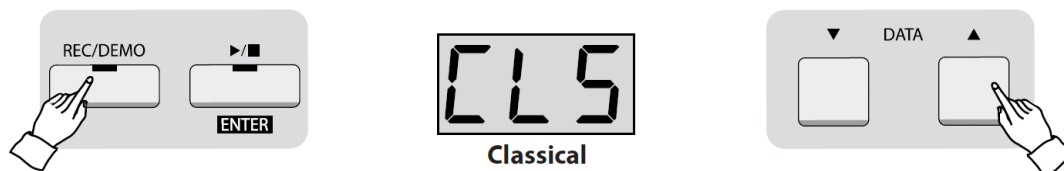

## Selection of a Music Folder

The instrument offers 7 music folders. These are a folder for DEMO songs and 6 more folders for piano etudes.

Use the DATA ▼▲ buttons to select between the different folders and open them by pressing the ENTER / ►/■ button.

<b>Display</b>	CLS	Ed1	Ed2	Ed3	Ed4	Ed5	Ed6
<b>Group</b>	Classical	Beyer	Burgmüller	Czerny100	Czerny30	Czerny40	Sonatine

If you want to leave the folder again, select "-" as the play title (first track of the list).

## To Select the Track for Playback

Use the DATA ▼▲ buttons to select between the different songs and start their playback by pressing the ENTER / ►/■ button.

All songs from Ed1-6 are divided into left (possibly with accompaniment) and right hand. By pressing the TRACK1 or TRACK2 button, left and right hands can be practiced separately.

If the respective TRACK button lights up, it is activated for playback. If the TRACK button does not light, it is muted. By repeatedly pressing the TRACK buttons their status (active / inactive) can be changed.

## Adjusting the Tempo



Each piece is stored at an individual tempo. You can change the tempo by pressing the PIANO ASSIST button during playback. Now you will hear the metronome in the respective speed of the song. The display also shows the tempo. Now use the ▼▲ buttons to adjust the tempo. Simultaneously press the both DATA ▼▲ buttons to reset the tempo to the default value. Press the PIANO ASSIST button again to deactivate the metronome.

## Further settings

In Playback mode, you can change the volume of the song, the playback option (only one song, all the songs in a row) and the key of the played song. See function-menu.

## Bluetooth

This instrument supports Bluetooth audio and Bluetooth MIDI connections.

### Bluetooth Audio

The default is PAIRING ON. Thus, immediate pairing is possible. Activate Bluetooth on the smart device (smartphone, tablet or similar) which you want to connect to the piano. Select the piano from the list of available Bluetooth devices displayed on your smart device. Once pairing is complete, you can hear the music you play on your smart device through the speakers of the piano.

## Bluetooth-MIDI

With the PAIRING-ON status selected, you can also pair your piano with MIDI-enabled applications on your smart device. To do this, select "BLE" as the MIDI device in the MIDI-enabled application.

 **NOTE** If there are connection problems, check in the function-menu whether the pairing status is ON.

Switch off the Bluetooth function of your Smart Device and start it again.

Check if there is already an automatic pairing with another device.

## BrainCare

The instrument has a separate BrainCare mode. To get into this operating state, turn off the instrument. Now press and hold the SETUP button and switch on the instrument. Hold down the SETUP button until the instrument is started in secured BrainCare mode. The display shows brn.

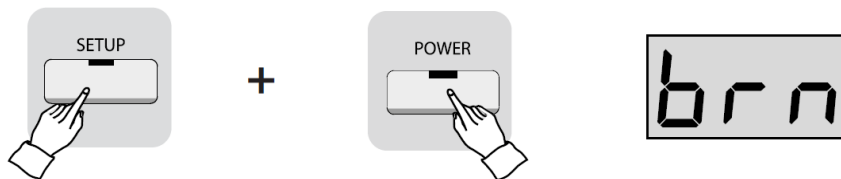

 **NOTE** There are no piano functions available in BrainCare mode.

In this operating mode, you can choose from different categories of background noise atmosphere with timer function. After expiry of the timer, the instrument switches off automatically.

These categories can be combined with each other. For example, as a sleeping aid you can underlay a relaxing piano piece with the sound of the sea.

Each row of the panel controls one level of the BrainCare categories. All three categories can be controlled independently. Only the timer function refers to the entire playback of BrainCare.



## Binaural Beat

Press the DUAL button to start Binaural Beat. By repeatedly pressing DUAL, you can scroll through the different sounds of Binaural Beats. Press the PIANO button to scroll backwards to the OFF status.

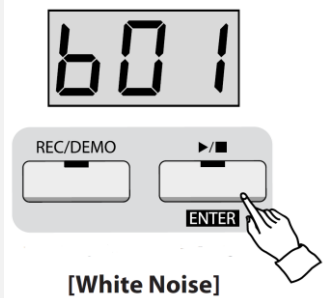

## White Noise

Press the ENTER / ►/■ button to start White Noise. Press ENTER / ►/■ several times to scroll through the different sounds of White Noise. Press the REC / DEMO button to scroll backwards to the OFF state.



## Healing Music

Press the TRACK2 button to start Healing Music. Press TRACK2 several times to scroll through the different sounds of Healing Music. Press the TRACK1 button to scroll backwards to the OFF status.

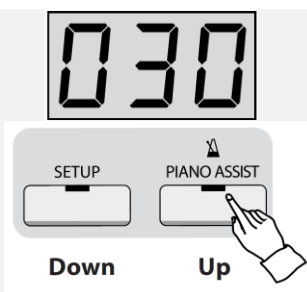

## Timer control

Press the PIANO ASSIST button to set the value for the timer. For example, at the value 30 the playback is stopped after 30min. Pressing the PIANO ASSIST button several times increases the value. Press the SETUP button to decrease the value. You can decrease the value till inactive status (000).

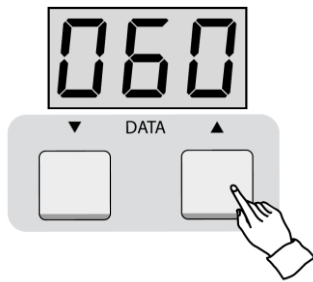

## Volume adjustment

It is possible to adjust the volume of each category of BrainCare individually. The individual categories can be mixed with simultaneous playback. To do this, use the ▼▲ buttons in the respective category to adjust the volume up or down.

To return to standard mode and exit BrainCare mode, turn the instrument off and start it again by pressing the POWER button.

## BrainCare Liste

Binaural Beat			White Noise			Healing Music		
Display	Title	Type	Display	Title	Type	Display	Composer	Title
A01	Alpha	Relax	b01	White Noise	Working	C01	Handel	Largo
A02	Beta	Working	b02	Vacuum Cleaner	Working	C02	Liszt	Liebesträume
A03	Gamma	Working	b03	Fan Noise	Working	C03	Gounod	Ave Maria
A04	Delta	Deep Sleep	b04	Jet Cavin	Working	C04	Chopin	Nocturne Op.9-1
A05	Theta	Meditation	b05	Galaxy Ship	Working	C05	Chopin	Nocturne Op.9-2
			b06	Baby for Sleep	Sleep	C06	Chopin	Nocturne Op.15-2
			b07	Sleep	Sleep	C07	Chopin	Nocturne Op.27-2
			b08	Sea Waves	Meditation	C08	Chopin	Nocturne Op.32-1
			b09	Crickets Night	Meditation	C09	Chopin	Nocturne Op.37-1
			b10	Rain Noise	Meditation	C10	Chopin	Nocturne Op.37-2

## Function-menu

Numerous settings can be made on the instrument with the function-menu.

Press the SETUP key to enter the function-menu.

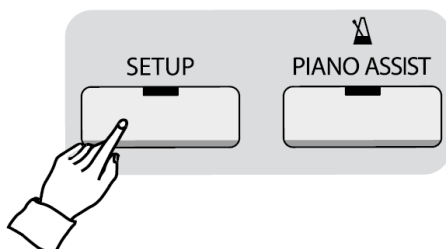

Use the DATA ▼▲ buttons to navigate to the desired function-menu dialog.

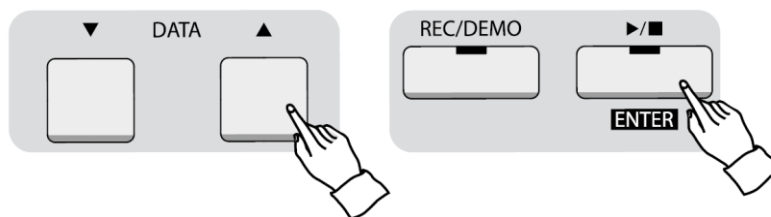

Press the ENTER / ►/■ button to enter the function-menu dialog and change the value with the DATA ▼▲ buttons. By simultaneously pressing the two DATA ▼▲ buttons return to their default value. Confirm with the ENTER / ►/■ button.

 **NOTE** If no entry is made for 10 seconds, the function-menu closes automatically.

## F01 Tune

Here you can adjust the tuning of your instrument to other instruments in Hertz steps up and down. The default is 440Hz.

## F02 Transpose

Here you can transpose the instrument up or down (adjust the pitch in semitones) to make it easier to playback pieces in hard-to-play keys.

## F03 Touch

Here you can adjust the touch sensitivity of the keyboard to your playing style. The following touch sensitivities are available.

Display	Name of the setting	Description
1	Soft 1	Recommended for players with a weak touch. Even with a light touch relatively loud sounds are played.
2	Soft 2	
3	Soft 3	
4	Normal 1	Simulates the touch sensitivity of an acoustic grand piano.
5	Normal 2	
6	Normal 3	
7	Hard 1	Recommended for players with a strong touch. This setting provides another dynamic range.
8	Hard 2	
9	Hard 3	
OFF	Fixed	All notes are played equally loud regardless of the touch

## **F04 Touch fixed Volume**

If F03 Touch Fixed is selected in the menu, the volume of the playback when the touch sensitivity is switched off can be set here.

## **F05 Metronome Time-Signature**

Here the time-signature of the metronome can be set.

The following possibilities are available:

0	no sound
2	2/4
3	3/4
4	4/4
5	5/4
6	6/8
7	7/8
8	8/8
9	9/8
10	10/8
11	11/8
12	12/8

## **F06 Metronome Volume**

Here, the volume of the metronome can be adjusted up or down.

The default is 80.

## **F07 Main Voice Volume**

Here you can adjust the volume of the Main Voice up or down.

## **F08 Layer Voice Volume**

Here you can adjust the volume of the Layer Voice up or down.

## **F09 Split Voice Volume**

Here you can adjust the volume of the Split Voice up or down.

## **F10 Split point**

Here the position of the split point can be moved. The display shows the note name and the octave (for example, Gb3 for the third Ges from the left).

## F11 Reverb Type

Here you can choose from 9 reverb types.

Display	Off	r-1	r-2	r-3	r-4	r-5	r-6	r-7	r-8	r-9
Name	No Reverb	Room 1	Room 2	Room 3	Hall 1	Hall 2	Hall 3	Stage 1	Stage 2	Stage 3

The default is r-3

## F12 Reverb Volume

Here you can adjust the volume of the Reverb up or down.

## F13 Effect Type

Here you can choose from 4 effect types.

Display	OFF	Chr	PhS	trE	rot
Name	No Effect	Chorus	Phase	Tremolo	Rotary

The default is OFF

## F14 Effect Volume

Here you can adjust the volume of the effect up or down.

The default is 80.

## F15 String Resonance

In addition to the sound of each played string, the acoustic piano has a unique string resonance phenomenon caused by sound interference between the piano strings. This function allows you to adjust the strength of the string resonance volume.

The default is 60. This function is only available on Main Voice G.P1-G.P4.

## F16 Damper Resonance

When you play the damper pedal on an acoustic piano, in addition to playing the notes you will hear certain strings of the piano reverberate. This is called damper resonance and is a natural reverberation that occurs in the piano corpus. This function allows you to set the damper resonance volume.

The default is 80. This function is only available with Main Voice G.P1-G.P4.



## F17 Corpus Resonance

In addition to damper and string resonance, an acoustic piano has a corpus resonance. With this function you can activate / deactivate the corpus resonance. Speaker resonances represent the resonances of the strings without damper (G6 C8) and the resonances delivered by the piano frame. When using REVERB, the corpus sound effect is not applied, so REVERB should be off.

This function is only available on Main Voice G.P1-G.P4.

## F18 Half-pedal

Here, the half-pedal function can be activated or deactivated.

The default is ON.

## F19 Piano Assist Mode

Here the mode of the Piano Assist function can be selected. There are two modes available:

<b>Display</b>	rhy	Pno
<b>Mode</b>	Rhythm (Drumbeat)	Piano Player performing aid

## F20 Piano Assist Multi-finger

Here you can select the mode of the chord recognition for the Piano Player performing aid of the Piano Assist function.

<b>Display</b>	ON	OFF
<b>Chord recognition</b>	Multi-finger is activated: The instrument allows chord indication through the fingered and single finger methods	Multi-finger is disabled: The instrument allows Fingered method only

The default is ON

## F21 Piano Assist Volume

Here the volume of the Piano Assist function can be adjusted up or down.

## F22 Music Playback Mode

Here you can select the mode for playing the demo songs and etudes.

<b>Display</b>	ALL	rEP	OFF
<b>Mode</b>	All songs will be played automatically one after the other	The selected song will be repeated continuously	The selected song will be played once and then stopped.

The default is ALL

## F23 Music Playback

Here you can adjust the volume of the played demo music / etudes up or down.

## F24 Transpose Music Playback

Here you can change the tuning of demo music and etudes in semitones up or down. This makes it easier to replay tracks in hard-to-play keys.

## F25 Bluetooth

Here you can enable or disable the piano's Bluetooth features.

The default is ON.

## F26 Bluetooth Volume

Here, the volume of music played using Bluetooth audio can be adjusted up or down.

## F27 AUX-In Volume

Here you can adjust the volume of the music played via AUX-In connection up or down.

## F28 MIDI Local

Here you can find Local-OFF setting for using the piano as a MIDI controller.

## F29 Auto Power Off

If the instrument is not used for a long time, it automatically shuts off to save energy.

Here you can set the value of the Auto Power Off function.

<b>Display</b>	OFF	030	120	240
<b>Shut off time</b>	APO is deactivated	30 Minutes	2 Hours	4 Hours

The default is 030

 **NOTE** This value will be stored when the instrument is switched off and is also valid when switched on again.

## rSt Reset

Resets the instrument to factory settings. Confirm this selection by pressing the ENTER / ►/■ button. Cancel by pressing the SETUP button.

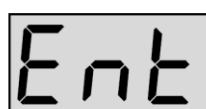

Enter

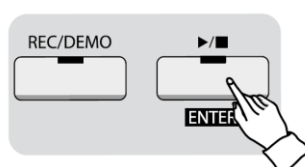

## MIDI Chart

Function		Recognized	Transmitted	Remark
Basic Channel	Default	ALL	1-3	
Mode	Default	OMNI OFF, POLY	OMNI OFF, POLY	
Note ON/OFF	9nH kk w	O	O	#kk:note ON (0-127) #vv:velocity (1-127)
Pitch Bender	EnH bi bh	O	O	Maximum swing +/- 1 tone
Control Change	00 BnH 00H cc	O	X	Bank Select
	01 BnH 01H cc	O	X	Modulation Wheel
	05 BnH 05H cc	O	X	Portamento Time
	06 BnH 06H cc	O	X	Data Entry
	07 BnH 07H cc	O	X	Volume
	10 BnH 0AH cc	O	X	Pan Out
	11 BnH 0BH cc	O	X	Expression
	64 BnH 40H cc	O	O	Damper Pedal
	65 BnH 41H cc	O	X	Portamento ON/OFF
	66 BnH 42H cc	O	O	Sostenuto Pedal
	67 BnH 43H cc	O	O	Soft Pedal
	80 BnH 80H wv	O	X	Reverb Prog.(vv=00H-70H)
	81 BnH 51H wv	O	X	Chorus Prog.
	91 BnH 5BH wv	O	O	Reverb Send Level
	93 BnH 5DH wv	O	O	Chorus Send Level
	120 BnH 78H 00H	O	X	All Sound Off
121 BnH 79H 00H	O	X	Reset All Controller	
123 BnH 7BH 00H	O	X	All Notes Off	
126 BnH 7EH 00H	O	X	Mono On	
127 BnH 7FH 00H	O	X	Poly On	
Program Change	CnH PP	O	O	Sounds/Drum Set List
System Exclusive	General MIDI Reset	X	X	

O:Yes, X:No

# STEINMAYER

## GM-Voice

(only with MIDI connection)

GM #	VOICE	GM #	VOICE
001	Grand Piano 1	065	Soprano Saxophone
002	Grand Piano 2	066	Alto Saxophone
003	Grand Piano 3	067	Tenor Saxophone
004	Honky Tonk	068	Baritone Saxophone
005	Electric Piano 1	069	Oboe
006	Electric Piano 2	070	English Horn
007	Harpsichord	071	Bassoon
008	Clavinet	072	Clarinet
009	Celesta	073	Piccolo
010	Glockenspiel	074	Flute
011	Music Box	075	Recorder
012	Vibraphone	076	Pan Flute
013	Marimba	077	Bottle Blow
014	Xylophone	078	Shakuhachi
015	Tubular Bell	079	Whistle
016	Dulcimer	080	Ocarina
017	Electric Organ 1	081	Square
018	Electric Organ 2	082	Sawtooth
019	Electric Organ 3	083	Calliope
020	Pipe Organ	084	Chiffer
021	Reed Organ	085	Charang
022	Accordion	086	Solo Vox
023	Harmonica	087	Fifths
024	Bandonion	088	Bass Lead
025	Nylon Guitar	089	Fantasia
026	Steel Guitar	090	Warm Pad
027	Jazz Guitar	091	Poly Synth
028	Clean Guitar	092	Space Vox
029	Muted Guitar	093	Bow Glass
030	Drive Guitar	094	Metal Pad
031	Lead Guitar	095	Halo Pad
032	Harmonic Guitar	096	Sweep Pad
033	Acoustic Bass	097	Ice Rain
034	Finger Bass	098	Sound Track
035	Pick Bass	099	Crystal
036	Fretless Bass	100	Atmosphere
037	Slap Bass 1	101	Brightness
038	Slap Bass 2	102	Goblin
039	Synth Bass 1	103	Echo Drop
040	Synth Bass 2	104	Star Theme
041	Violin	105	Sitar
042	Viola	106	Banjo
043	Cello	107	Shamishen
044	Contra Bass	108	Koto
045	Tremolo Strings	109	Kalimba
046	Pizzicato Strings	110	Bagpipe
047	Harp	111	Fiddle
048	Timpani	112	Shanai
049	Strings	113	Tinkle Bell
050	Slow Strings	114	Agogo
051	Synth Strings 1	115	Steel Drum
052	Synth Strings 2	116	Wood Block
053	Choir Aahs	117	Taiko
054	Voice Oohs	118	Melody Tom
055	Synth Voice	119	Synth Drum
056	Orchestra Hit	120	Reversed Cymbal
057	Trumpet	121	Guitar Noise
058	Trombone	122	Breath Noise
059	Tuba	123	Sea Shore
060	Muted Trumpet	124	Birds
061	French Horn	125	Telephone
062	Brass Section	126	Helicopter
063	Synth Brass 1	127	Applause
064	Synth Brass 2	128	Gunshot

## Percussion

(If two different effects are specified, they will react depending on the strength of the touch)

	Prog 59 SFX1 (SFX Set)
21 - A0	Low
22 - A#0	Bass Drum
23 - B0	Snare Drum Left Hand
24 - C1	Snare Drum Right Hand
25 - C#1	Bongo
26 - D1	Guiro
27 - D#1	Conga
28 - E1	Whistle
29 - F1	Sogo
30 - F#1	Cymbal
31 - G1	Castanets
32 - G#1	Triangle
33 - A1	Maracas
34 - A#1	Tambourine
35 - B1	Low/High (Woodblock Low/High)
36 - C2	Double Low C
37 - C#2	Jingle
38 - D2	Rocket Fire
39 - D#2	Jing
40 - E2	One
41 - F2	Two
42 - F#2	Scoundrel's Laugh
43 - G2	Three
44 - G#2	Cricket
45 - A2	Four
46 - A#2	Fairy
47 - B2	Five
48 - C3	Low C
49 - C#3	Samul Janggu L-1
50 - D3	Claps
51 - D#3	Samul Janggu L-2
52 - E3	Claps
53 - F3	Short/Long
54 - F#3	Samul Janggu M
55 - G3	Soft/Loud
56 - G#3	Samul Janggu R-1
57 - A3	Good/Very Good
58 - A#3	Samul Janggu R-2
59 - B3	Table Clock
60 - C4	Middle C
61 - C#4	Cuckoo
62 - D4	Bird
63 - D#4	Whistle Bird
64 - E4	Hen/Cackling

	Prog 59 SFX1 (SFX Set)
65 - F4	Chicks/Rooster
66 - F#4	Duck
67 - G4	Cat
68 - G#4	Dog
69 - A4	Goat
70 - A#4	Pig
71 - B4	Cow
72 - C5	High C
73 - C#5	Small Gong-1
74 - D5	Horse
75 - D#5	Small Gong-2
76 - E5	Horse Running
77 - F5	Frog/Frogs
78 - F#5	Splash
79 - G5	Swan+Bubble
80 - G#5	Comical Sound
81 - A5	Wolf
82 - A#5	Children's Laugh
83 - B5	Tiger
84 - C6	Double High C
85 - C#6	Samul Drum 1
86 - D6	Bear
87 - D#6	Samul Drum 2
88 - E6	Elephant
89 - F6	Bicycle
90 - F#6	Wall Clock+Pendulum
91 - G6	Bell
92 - G#6	Stream
93 - A6	Car
94 - A#6	Sea Waves/Waterfall
95 - B6	Train/Train+Whistle
96 - C7	Rain
97 - C#7	Forest
98 - D7	Wind
99 - D#7	Wind Chime
100 - E7	Thunder
101 - F7	Deep Sea
102 - F#7	The Sea
103 - G7	Bubble
104 - G#7	Fish Bubble
105 - A7	Robot
106 - A#7	Telephone
107 - B7	Helicopter/Siren
108 - C8	High

## Trouble Shooting

If a malfunction occurs, please check the following causes of error:

Error	Cause	Solution
The piano does not turn on	<ol style="list-style-type: none"> <li>1.The power cord is not plugged in</li> <li>2.The instrument is not turned on</li> <li>3.The outlet has no power</li> </ol>	<ol style="list-style-type: none"> <li>1.Plug in the power cord properly</li> <li>2.Turn on the instrument</li> <li>3.Use another outlet</li> </ol>
The piano does not emit sound from the speakers	<ol style="list-style-type: none"> <li>1.The volume is set to the lowest value</li> <li>2.A headphone (adapter) is in the headphone jack</li> <li>3.The power cord is not plugged in</li> </ol>	<ol style="list-style-type: none"> <li>1. Increase the volume setting</li> <li>2.Remove the headphone (adapter) from the headphone jack</li> <li>3.Plug the instrument into an electrical outlet</li> </ol>
The volumes of the different voices are very different	The volume adjustment in the function-menu is changed	Reset the volume levels in the function-menu to the default values
The instrument emits noises	<ol style="list-style-type: none"> <li>1.There are devices with disturbing features (freezer, washing machine or similar) in the immediate vicinity</li> <li>2.Objects on or near the instrument resonate with</li> <li>3.The noise occurs only when using a headphone</li> </ol>	<ol style="list-style-type: none"> <li>1.Remove the piano from the vicinity of other electrical appliances (especially those with motors)</li> <li>2.Remove resonant objects from the surroundings of the piano</li> <li>3.Clean the headphone plug or replace the headphone</li> </ol>
The instrument does not pass any sound through the AUX-OUT connector	<ol style="list-style-type: none"> <li>1.The volume is set to the minimum value</li> <li>2.The connection cable is damaged</li> </ol>	<ol style="list-style-type: none"> <li>1. Increase the volume</li> <li>2.Replace the connection cable</li> </ol>

## Product Specifications

Keyboard	88 touch-sensitive hammer keys
Touch-sensitivity	10 levels (Soft 1/2/3, Normal 1/2/3, Hard 1/2/3, Fixed)
Max. Polyphony	256
Voices	34 + 1 Drum-Set + 1 SFX-Set
Dual	Layer, Split, TwinPiano
DSP	9 Reverb, 4 Effect
Demo	50
Piano Assist	PianoPlayer 20, DrumPlayer 20
Record function	2 tracks in 3 banks (4500 Note/Track)
Bluetooth	Bluetooth-Audio, Bluetooth-MIDI Bluetooth 5.0 Dual Mode, Class2  Frequency spectrum: 2.402 GHz to 2.480 GHz • Receive sensitivity: -90 dBm (2 Mbps EDR) • Output Power - BM62/64 Class 2: +2 dBm typical
BrainCare	5 Binaural Beats, 10 White Noise, 10 Healing Music
Pedals	3 (Soft, Sostenuto, Sustain)
Half-pedal	Yes (right pedal)
Connections	AUX In/Out, USB to Host, 2x headphone (3,5mm+6,35mm), pedal, power supply
Speaker	(16cm x 8cm)x2
Power consumption max.	36W
Supplied accessories	Power supply 18V,2A, + inside

## WEEE Declaration

### (Waste of Electrical and Electronic Equipment)

Your product has been designed and manufactured using high quality materials and components that are recyclable and reusable. This symbol means that electrical and electronic equipment must be disposed of separately from household waste at the end of their service life.

Please dispose of this device at your local municipal collection point or at the recycling center.

Please help protect the environment in which we all live.

All specifications and appearance are subject to change without notice. All information was correct at the time of printing. Musikhaus Kirstein GmbH assumes no responsibility for the accuracy or completeness of the descriptions, photos or statements contained in this manual. Printed colors and specifications may vary slightly from the product. Products of Musikhaus Kirstein GmbH are distributed only through authorized dealers. Distributors and dealers are not representatives of Musikhaus Kirstein GmbH and are not authorized to legally bind Musikhaus Kirstein GmbH in any way, whether expressly or through conclusive action. This manual is protected by copyright. Any duplication, or any reprint, even in extracts, and any reproduction of the illustrations, even in altered condition, is only permitted with the written consent of the company Musikhaus Kirstein GmbH.

#### **SIMPLIFIED EU DECLARATION OF CONFORMITY**

Herewith Musikhaus Kirstein GmbH declares that the radio unit of Model is in compliance with the EU directive 2014/53/EU.

You can download the full EU declaration of conformity for this item under download link:

[http://www.kirstein.de/docs/Konformitaetserklaerung/CE\\_Konformitaetserklaerung\\_00063251.pdf](http://www.kirstein.de/docs/Konformitaetserklaerung/CE_Konformitaetserklaerung_00063251.pdf)



**Musikhaus Kirstein GmbH**

**Bernbeurener Str. 11**

**86956 Schongau – Germany**

**Telefon/Phone: 0049-8861-909494-0**

**Telefax/Fax: 0049-8861-**

