



KH-10

VORSICHTSMASSNAHMEN (BITTE SORGFÄLTIG DURCHLESEN). Kinder sollten beaufsichtigt werden, um sicherzustellen, dass sie dieses Produkt nicht als Spielzeug verwenden. Lassen Sie Kinder niemals unbeaufsichtigt mit dem Verpackungsmaterial spielen. Warnhinweise: Lesen Sie diese Anweisungen und bewahren Sie diese Anleitung auf. Verwenden Sie dieses Gerät nicht im Wasser. Vorsichtsmaßnahmen: Um Schäden am Produkt zu vermeiden, bringen Sie es nicht an Plätze mit hohen Temperaturen oder viel Staub, sehr niedriger oder hoher Luftfeuchtigkeit, legen Sie es nicht direkt neben eine Klimaanlage und vermeiden Sie direkte Sonneneinstrahlung. Wenden Sie im Umgang mit dem Produkt keinerlei Gewalt an. Ort: Setzen Sie das Produkt nicht den folgenden Bedingungen aus, um Verformungen, Verfärbungen oder größere Schäden zu vermeiden: Direktes Sonnenlicht, extreme Temperatur oder Luftfeuchtigkeit, übermäßig staubiger oder schmutziger Ort. Reinigung: Reinigen Sie das Produkt nur mit einem weichen, trockenen Tuch. Verwenden Sie keine Farbverdünner, Lösungsmittel, Reinigungsflüssigkeiten oder chemisch imprägnierte Wischtücher. Technische Änderungen und Änderungen im Erscheinungsbild sind vorbehalten. Alle Angaben entsprechen dem Stand bei Drucklegung. Für die Richtigkeit und Vollständigkeit der enthaltenen Beschreibungen, Abbildungen und Angaben übernimmt Musikhaus Kirstein GmbH keinerlei Gewähr. Abgebildete Farben und Spezifikationen können geringfügig vom Produkt abweichen. Musikhaus Kirstein GmbH - Produkte sind nur über autorisierte Händler erhältlich. Distributoren und Händler sind keine Handlungsbevollmächtigten von Musikhaus Kirstein GmbH und haben keinerlei Befugnis, die Musikhaus Kirstein GmbH in irgendeiner Weise, sei es ausdrücklich oder durch schlüssiges Handeln, rechtlich zu binden. Diese Bedienungsanleitung ist urheberrechtlich geschützt. Jede Vervielfältigung, bzw. jeder Nachdruck, auch auszugsweise, und jede Wiedergabe der Abbildungen, auch in verändertem Zustand, ist nur mit schriftlicher Zustimmung der Firma Musikhaus Kirstein GmbH gestattet.

WARNUNG: Achten Sie auf eine angemessene Lautstärke! Hören mit zu hohem Lautstärkepegel kann Ihr Gehör dauerhaft schädigen!



FUNKTION UND HANDHABUNG Der Kopfhörer kann mit allen handelsüblichen Abspielgeräten, wie CD-Playern, Stereoanlagen, mobilen Musik-Playern verwendet werden, welche über einen Kopfhörerausgang mit 3,5mm Stereo-Klinke verfügen. Sollte Ihre Soundquelle mit einem Kopfhörerausgang mit 6,3mm Stereo-Klinke ausgestattet sein, nutzen Sie den mitgelieferten Adapter (6,3mm zu 3,5mm Stereoklinkenbuchse).

WARTUNG: Ihr Gerät erfordert keine besondere Wartung. Wenden Sie sich im Falle einer Fehlfunktion an ein zugelassenes Servicecenter oder direkt an den Hersteller.

REINIGUNG: Verwenden Sie zur Reinigung ein fusselfreies, trockenes oder nur leicht angefeuchtetes Tuch.

TECHNISCHE DATEN: System: dynamischer Kopfhörer Stereo, Nennimpedanz: 32Ohm +/- 10%, Frequenzbereich: 20-20000Hz, Empfindlichkeit: 103dB S.P.L. bei 1kHz +/- 2%

WEEE-Erklärung (Waste of Electrical and Electronic Equipment) Ihr Produkt wurde unter Verwendung hochwertiger Materialien und Komponenten entwickelt und hergestellt, die recycelbar und wiederverwendbar sind. Dieses Symbol bedeutet, dass elektrische und elektronische Geräte am Ende ihrer Lebensdauer vom Hausmüll getrennt entsorgt werden müssen. Bitte entsorgen Sie dieses Gerät bei Ihrer örtlichen kommunalen Sammelstelle oder im Recycling-Center. Bitte helfen Sie mit, die Umwelt zu schützen, in der wir alle leben.



Musikhaus Kirstein GmbH, Bernbeurener Strasse 11, 86956 Schongau, Germany, [Tel:08861-909494-0](tel:08861-909494-0), info@kirstein.de



KH-10

PRECAUTIONS (PLEASE READ CAREFULLY). Children should be supervised to ensure that they do not use this product as a toy. Never allow children to play with the packaging material unsupervised. Warnings: Read these instructions and keep these instructions in a safe place. Do not use this appliance in water. Precautions: To avoid damage to the product, do not place it in places with high temperatures or a lot of dust, very low or high humidity, do not place it directly next to an air conditioner and avoid direct sunlight. Do not use force when handling the product. Location: Do not expose the product to the following conditions to avoid deformation, discoloration or major damage: Direct sunlight, extreme temperature or humidity, excessively dusty or dirty place. Cleaning: Only clean the product with a soft, dry cloth. Do not use paint thinners, solvents, cleaning fluids or chemically impregnated wiping cloths. We reserve the right to make technical changes and changes in appearance. All information is correct at the time of printing. Musikhaus Kirstein GmbH accepts no liability for the accuracy and completeness of the descriptions, illustrations and information contained herein. Colors and specifications shown may differ slightly from the product. Musikhaus Kirstein GmbH products are only available through authorized dealers. Distributors and dealers are not authorized agents of Musikhaus Kirstein GmbH and have no authority to legally bind Musikhaus Kirstein GmbH in any way, whether expressly or by implication. These operating instructions are protected by copyright. Any duplication or reprinting, even in part, and any reproduction of the illustrations, even in modified form, is only permitted with the written consent of Musikhaus Kirstein GmbH.

WARNING: Ensure an appropriate volume level! Listening at too high a volume level can permanently damage your hearing!



FUNCTION AND HANDLING The headphones can be used with all commercially available playback devices such as CD players, stereo systems and mobile music players that have a headphone output with a 3.5mm stereo jack. If your sound source is equipped with a headphone output with a 6.3 mm stereo jack, use the supplied adapter (6.3 mm to 3.5 mm stereo jack).

MAINTENANCE: Your appliance does not require any special maintenance. In the event of a malfunction, contact an approved service center or the manufacturer directly.

CLEANING: Use a lint-free, dry or slightly damp cloth for cleaning.

TECHNICAL DATA: System: dynamic stereo headphones, nominal impedance: 32Ohm +/- 10%, frequency range: 20-20000Hz, sensitivity: 103dB S.P.L. at 1kHz +/- 2%

WEEE declaration (Waste of Electrical and Electronic Equipment) Your product has been developed and manufactured using high-quality materials and components that are recyclable and reusable. This symbol means that electrical and electronic equipment must be disposed of separately from household waste at the end of its life. Please dispose of this appliance at your local municipal collection point or recycling center. Please help to protect the environment in which we all live.



Classic Cantabile

CPK-403

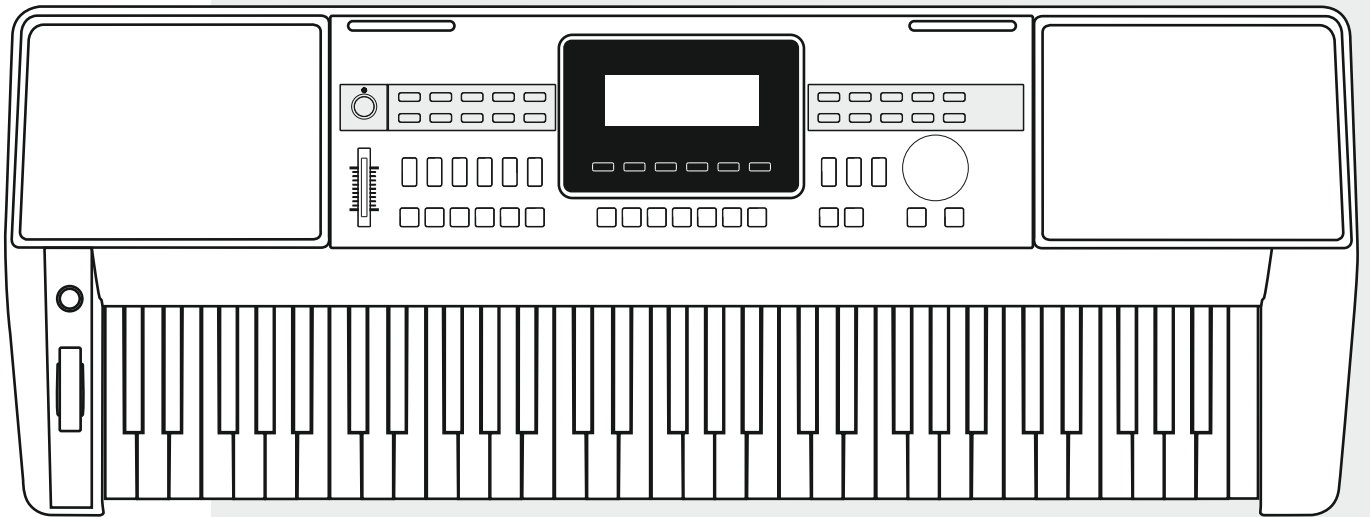

Owner's Manual

Version 07/2019

INFORMATION FOR YOUR SAFETY!

THE FCC REGULATION WARNING (for USA)

This equipment has been tested and found to comply with the limits for a Class B digital device, pursuant to Part 15 of the FCC Rules.

These limits are designed to provide reasonable protection against harmful interference in a residential installation. This equipment generates, uses, and can radiate radio frequency energy and, if not installed and used in accordance with the instructions, may cause harmful interference to radio communications. However, there is no guarantee that interference will not occur in a particular installation. If this equipment does cause harmful interference to radio or television reception, which can be determined by turning the equipment off and on, the user is encouraged to try to correct the interference by one or more of the following measures:

- Reorient or relocate the receiving antenna.
- Increase the separation between the equipment and receiver.
- Connect the equipment into an outlet on a circuit different from that to which the receiver is connected.
- Consult the dealer or an experienced radio/TV technician for help.

Unauthorized changes or modification to this system can void the user's authority to operate this equipment.

CAUTION

The normal function of the product may be disturbed by Strong Electro Magnetic Interference. If so, simply reset the product to resume normal operation by following the owner's manual. In case the function could not resume, please use the product in other location.

PRECAUTIONS

PLEASE READ CAREFULLY BEFORE PROCEEDING

Please keep this manual in a safe place for future reference.

Power Supply

Please connect the designated AC adaptor to an AC outlet of the correct voltage.

Do not connect it to an AC outlet of voltage other than that for which your instrument is intended.

Unplug the AC power adaptor when not using the instrument, or during electrical storms.

Connections

Before connecting the instrument to other devices, turn off the power to all units. This will help prevent malfunction and / or damage to other devices.

Location

Do not expose the instrument to the following conditions to avoid deformation, discoloration, or more serious damage:

- Direct sunlight
- Extreme temperature or humidity
- Excessive dusty or dirty location
- Strong vibrations or shocks
- Close to magnetic fields

Interference with other electrical devices

Radios and televisions placed nearby may experience reception interference. Operate this unit at a suitable distance from radios and televisions.

Cleaning

Clean only with a soft, dry cloth.

Do not use paint thinners, solvents, cleaning fluids, or chemical-impregnated wiping cloths.

Handling

Do not apply excessive force to the switches or controls.

Do not let paper, metallic, or other objects into the instrument. If this happens, unplug the AC adaptor from the wall outlet. Then have the instrument inspected by qualified service personnel.

Disconnect all cables before moving the instrument.

Panel & Display Description

Front Panel

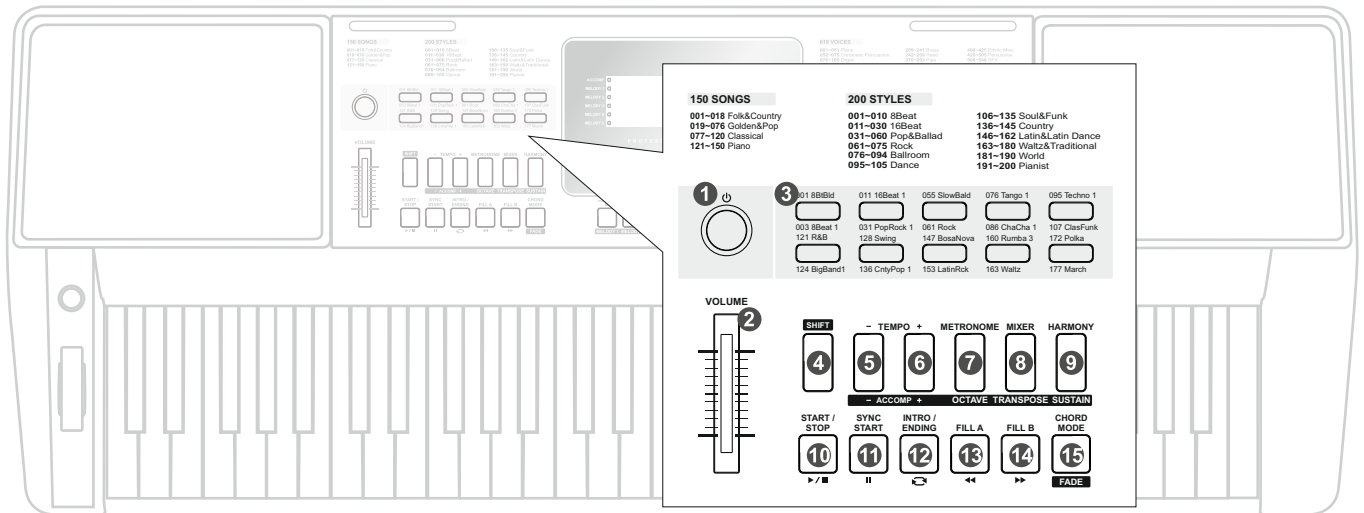

1. POWER SWITCH
Turn the Power on or off.

2. [VOLUME] Slider
Adjust the master Volume.

3. STYLE DIRECT SELECT BUTTON
Select a direct Style.

4. [SHIFT] button
Select the second function of some buttons.

- In Song Mode**
- 10. [▶/■] button**
Start or Stop playing the song.
 - 11. [⏸] button**
Pause or continue playing the song.
 - 12. [↺] button**
Set the beginning and ending location of loop to the current song.
 - 13. [◀◀] button**
Rewind the song.
 - 14. [▶▶] button**
Fast forward the song.

- In Style Mode**
- 10. [START/ STOP] button**
Start or Stop playing the style.
 - 11. [SYNC START] button**
Turn the Sync Start function on or off.
 - 12. [INTRO/ ENDING] button**
Play the Intro or Ending.
 - 13. [FILL A] button**
A Fill-in A plays.
 - 14. [FILL B] button**
A Fill-in B plays.

When the [SHIFT] button released
5~6. [TEMPO +]~ [TEMPO -] button
Adjust the current Tempo.

When the [SHIFT] button pressed
5~6. [ACCOMP +]~ [ACCOMP -] button
Adjust the ACCOMP volume.

7. [METRONOME] button
Turn the metronome on or off.

7. [OCTAVE] button
Enter the Octave setting.

8. [MIXER] button
Enter the Mixer menu.

8. [TRANPOSE] button
Enter the Transpose setting.

9. [HARMONY] button
Turn the Harmony effect on or off.

9. [SUSTAIN] button
Turn the Sustain function on or off.

15. [CHORD MODE] button
Enter the chord mode.

15. [FADE] button
Produce smooth Fade-ins or Fade-outs at the beginning or end of style playback.

Rear Panel

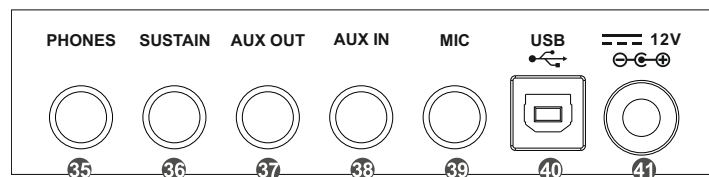

35. PHONE jack
Connect a pair of headphones.

38. AUX IN jack
Connect an external sound source, such as an MP3 or CD player.

40. USB terminal
Connect to a computer.

36. SUSTAIN jack
Connect a sustain pedal.

39. MIC jack
Connect a microphone.

41. DC 12V jack
Connect DC 12V power adaptor.

37. AUX OUT jack
Connect the audio equipment.

Panel & Display Description

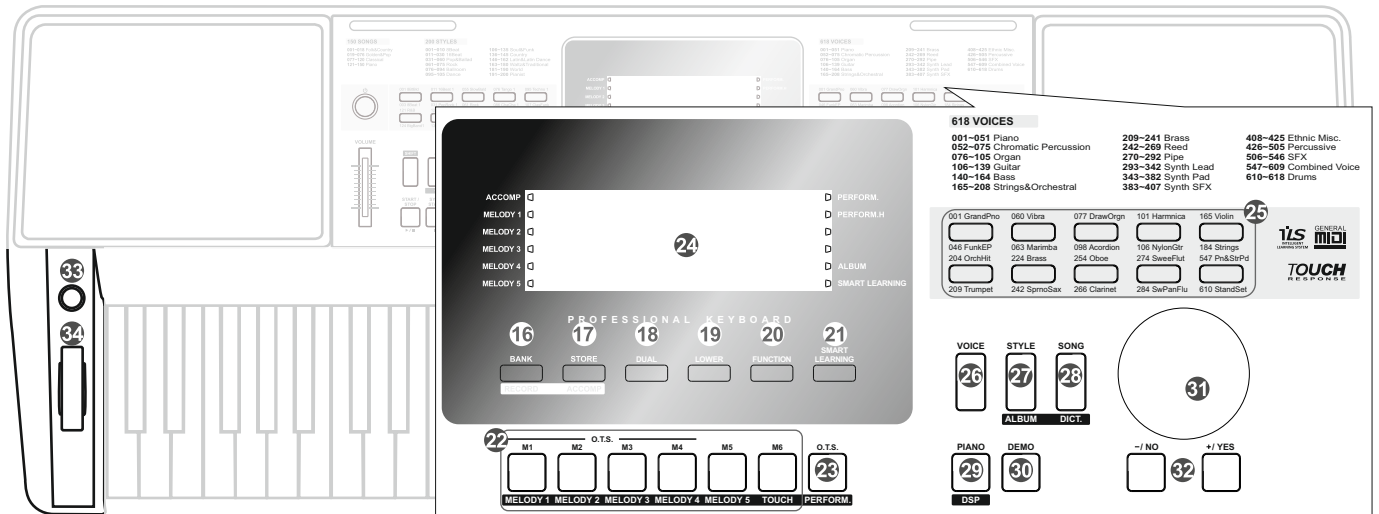

- | | | | |
|--|---|--|---|
| <p>18. [DUAL] button
Turn the Dual function on or off.</p> <p>19. [LOWER] button
Turn the Lower function on or off.</p> <p>20. [FUNCTION] button
Enter the Function Mode.</p> <p>21. [SMART LEARNING] button
Turn the Smart Learning function on or off.</p> <p>24. [LCD]
Display the useful information while using this keyboard.</p> <p>25. VOICE DIRECT SELECT BUTTON
Select a direct Voice.</p> | <p>26. [VOICE] button
Switch to Voice Mode.</p> <p>30. [DEMO] button
Switch to Demo Mode.</p> <p>31. DATA DIAL
Slowly or quickly adjust the parameter value.</p> <p>32. [-/NO]/ [+YES] button
Adjust parameter value.</p> <p>33. [MODULATION] button
Apply a vibrato effect.</p> <p>34. [PITCH BEND] wheel
Bend notes up or down.</p> | <p>When the [SHIFT] button Released</p> <p>16. [BANK] button
Switch between Memories.</p> <p>17. [STORE] button
Register the panel settings.</p> <p>22. [M1] ~ [M6] buttons
Recall the registered panel settings. In O.T.S. mode, only M1-M4 are available.</p> <p>23. [O.T.S.] button
Turn one touch setting on or off.</p> <p>27. [STYLE] button
Switch to Style Mode.</p> <p>28. [SONG] button
Enter the Song Mode.</p> <p>29. [PIANO] button
Enter the Piano Mode.</p> | <p>When the [SHIFT] button Pressed</p> <p>16. [RECORD] button
Enter the Record Mode.</p> <p>17. [ACCOMP] button
Select the accompaniment track when recording.</p> <p>22. [MELODY 1] ~ [MELODY 5] buttons
Select the melody track from melody 1 - melody 5 when recording. [TOUCH] button Turn the Touch Response on or off.</p> <p>23. [PERFORM.] button
Turn the Performance Assistant function on or off.</p> <p>27. [ALBUM] button
Turn the Album function on or off.</p> <p>28. [DICT.] button
Enter the Chord Dictionary.</p> <p>29. [DSP] button
Turn the DSP function on or off.</p> |
|--|---|--|---|

LCD

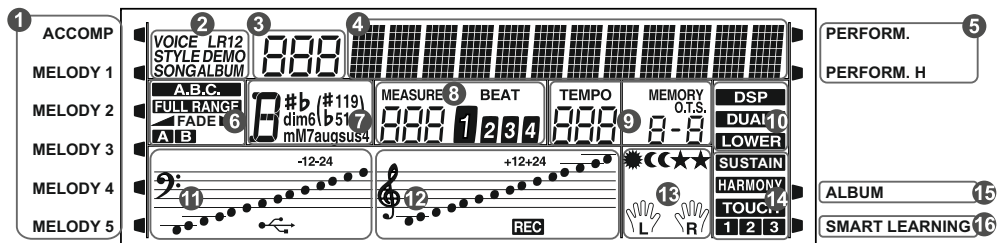

- | | | |
|---|--|---|
| <p>1. ACCOMP/ MELODY 1-5</p> <p>2. VOICE/ STYLE/ DEMO/ SONG/ ALBUM</p> <p>3. NUMBER</p> <p>4. CHARACTER</p> <p>5. PERFORMANCE ASSISTANT/ PERFORMANCE ASSISTANT HIGH</p> | <p>6. A.B.C. / FULL RANGE/ FADE/ ACCOMPANIMENT SECTION</p> <p>7. CHORD</p> <p>8. MEASURE/ BEAT</p> <p>9. TEMPO/ MEMORY/ O.T.S./ BANK</p> <p>10. DSP/ DUAL/ LOWER</p> <p>11. BASE CLEF/ USB</p> | <p>12. TREBLE CLEF/ RECORD</p> <p>13. GRADE LEVEL/LEFT HAND/ RIGHT HAND</p> <p>14. SUSTAIN/ HARMONY/ TOUCH (1-3)</p> <p>15. ALBUM</p> <p>16. SMART LEARNING</p> |
|---|--|---|

Setup

This section contains information about setting up your instrument and preparing to play. Please go through this section carefully before turning the power on.

Power Supply

You can power the instrument either by batteries or by power adaptor. Follow the instructions described below.

Using Batteries

6 pieces of AA (NO.5) or equivalent alkaline batteries must first be installed into the battery compartment.

1. Open the battery compartment cover located on the bottom cabinet of the unit.
2. Insert the batteries; carefully follow the polarity markings on the cabinet.
3. Replace the compartment cover, making sure that it locks firmly in place.

Note:

1. Do not mix old and new batteries.
2. Always use same types of batteries.
3. Always remove the batteries from the unit when it is not being used for an extended period of time.

Using Power Adaptor

1. First, please make sure that POWER ON/OFF switch of the instrument is set to OFF.
2. Connect the AC adaptor to the power supply jack.
3. Plug the AC adaptor into an AC outlet. And when turning the power OFF, simply reverse the procedure please. This will automatically cut off the battery power supply.

Note:

1. In the idle mode, the instrument will automatically shutdown in 30 minutes if you do not take any action on the instrument (Please refer to "Auto Power Off" for details).
2. When the keyboard is not in use or during thunderstorm, please disconnect the power for safety.

Setting a Music Stand

A music stand is supplied with the keyboard. You can easily attach it to the instrument by inserting it into the slots at the rear of the panel.

Using Sustain Pedal

When using a sustain pedal in playing, your performance will remain an elegant sustain with hands out of keys, which makes the performance more expressive and abundant. Plug an optional pedal into this jack and use it to switch sustain on and off.

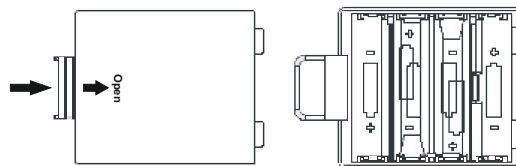

12V

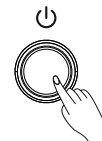
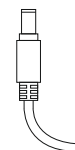

VOLUME

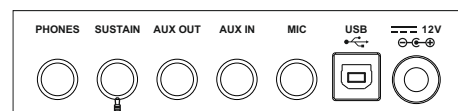
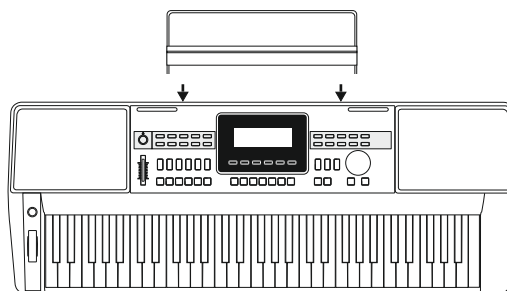
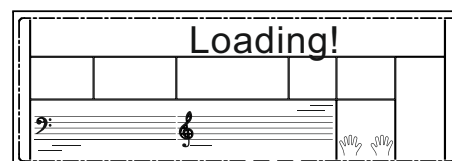
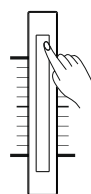

Connecting a pair of Headphones

1. A standard pair of stereo headphones can be connected to the PHONES jack for private practice or late-night playing.
2. The internal stereo speaker system is automatically shut off when a pair of head phones is plugged into this jack.

Note:

To avoid the risk of hearing loss when using headphones, please do not play the piano with a high volume level for a long time.

Connecting an Audio Equipment

The rear-panel AUX.OUT jack delivers the output of the instrument for connection to a keyboard amplifier, stereo sound system, a mixing console, or tape recorder. Use an audio cord to plug into the AUX.OUT jack located on the rear panel then plug the other end of the cord into AUX.IN of the amplifier.

Note:

To avoid damaging the speakers, please ensure that all connected audio equipments are turned off and the volume has been set to the minimum level before connecting the power and other devices.

Connecting an MP3/CD Player

Connect the audio output of an MP3/CD player or other audio source to the stereo AUX IN jack on the rear panel. The input signal is mixed with the instrument signal, allowing you to play along.

Connecting a Computer

The instrument can be connected to a computer by a USB cable. You can store your song playing to computer, or play the MIDI songs from computer.

Using a transverter between the piano MIDI IN /OUT terminal and the computer USB terminal can also transmit MIDI data.

Note:

1. Don't set the USB audio as input and output simultaneously on the computer software, or it may sound overlapped when play a note.
2. We recommend you using a USB 2.0 port to connect with your computer while you are using a USB 3.0 port and the instrument cannot work correctly.

Connecting a Microphone

By connecting a microphone, you can enjoy singing along with your keyboard performance or with Song playback (KARAOKE).

1. Before turning the power on, set the master volume to minor value.
2. Connect a microphone to the [MIC] jack.
3. Turn the power on. Adjust the master volume value while singing into the microphone.

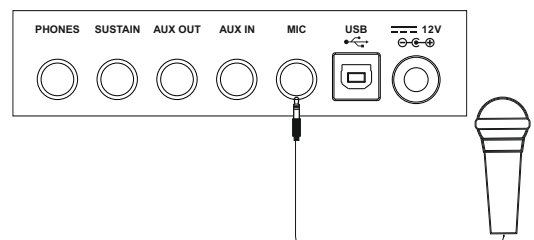
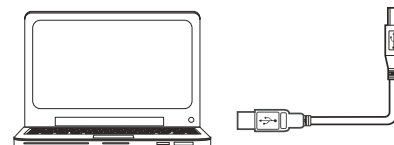
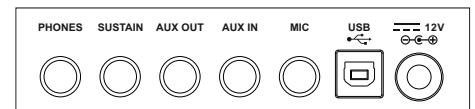
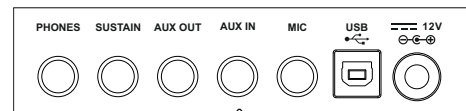
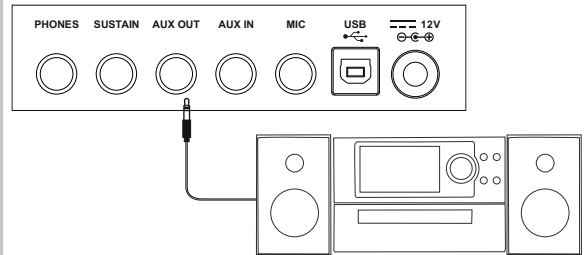
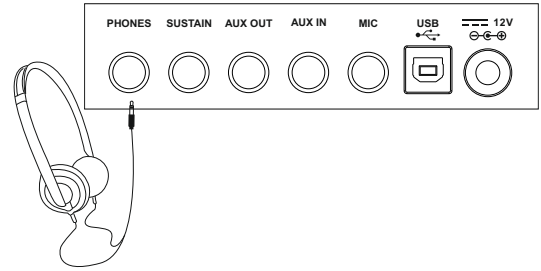

Power Switch and Master Volume

Power Switch

Before you switch your instrument on, please turn down the volume of instrument and the connected audio equipment first.

1. Firstly, please make sure you have correctly completed power connection.
2. Press POWER SWITCH, the LCD screen is lit, and displays "Loading!" on the screen, it indicates the instrument is powered on.

Note:

If the LCD display does not light up after you turned on the keyboard, please check the power supply.

Master Volume

Move the MASTER VOLUME slider upwards/ downwards to increase/ decrease the volume level. Adjust an appropriate value as you like.

Note:

The overall volume is too low, or no sound is heard. The master volume may set too low. Set it to an appropriate level with the [MASTER VOLUME] slider. Another reason could be the headphones are connected, disabling the speak output. Try to unplug the headphones.

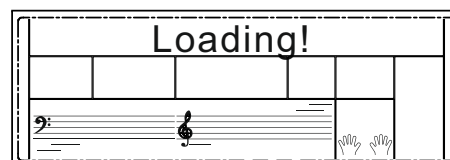

VOLUME

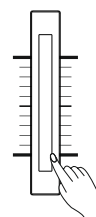

Playing Demo Songs

This instrument features 5 wonderful demos with different characters. (Please refer to Demo List.)

1. Press the [DEMO] button, enter the main interface of demo playing back, The LCD displays current demo number and name, meanwhile, all the demo songs will loop playing.
2. Use the data dial or the [+ /Yes] / [- /No] button to select a demo song.
3. Press the [START/STOP] button to stop playing and exit the demo mode.
Or you can press the [DEMO] button again.

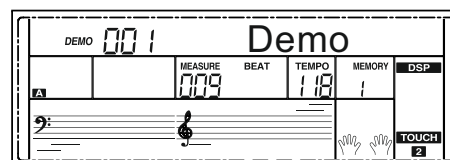

Playing Voices

The keyboard has 618 remarkably realistic built-in voices, including Piano, Woodwind, Saxophone, Drum Kits and many more. Please refer to Voice List.

1. Press the [VOICE] button.
Enter the Voice Mode. The LCD displays the current default voice name and number.
2. Select a Voice.
Use the data dial or the [+ /Yes] / [- /No] button to select the voice you want to play. You can also use the Voice Direct Button to select a voice. 2 direct voices for each button (upper & lower key).
3. Play the Voice.
You can play the keyboard and listen to the wonderful voice.

Note:

While changing a voice, pay attention to the rules. If you press the same button, the voice will be changed between the upper and lower key. When the upper/lower voice is on, and then you press another direct button, the corresponding upper/lower voice will be selected.

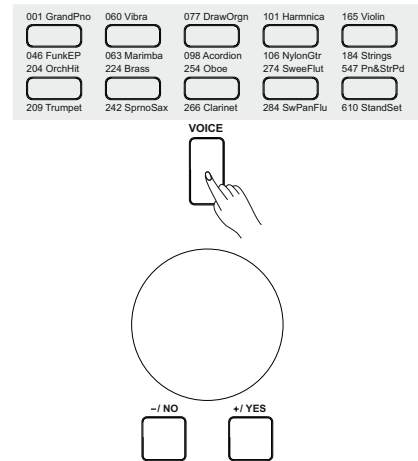

Playing Styles

The instrument features 200 styles in a variety of different musical genres. Try selecting some of the different styles (Please refer to the Style List) and playing with the auto accompaniment.

1. Press the [STYLE] button.
Enter the Style Mode. The LCD displays the current default style name and number.
2. Select a Style.
Use the data dial or the [+ /Yes] / [- /No] button to select the style you want to play. You can also use the Style Direct Button to select a style. 2 direct styles for each button (upper & lower key).
3. Play the Style.
Press the [START/STOP] button, directly start a rhythm playing.

Note:

While changing a style, please pay attention to the rules. If you press the same button, the style will be changed between the upper and lower key. When the upper/lower style is on, and then you press another direct button, the corresponding upper/lower style will be selected.

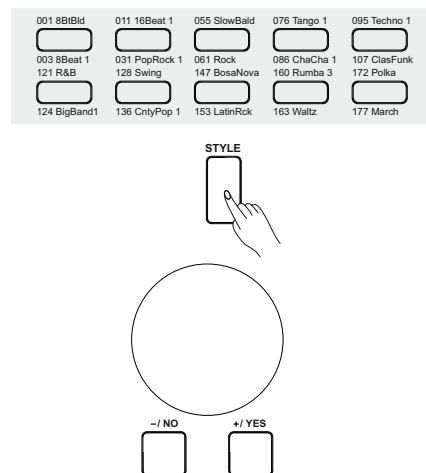

Playing Songs

This instrument has featured 150 preset songs, and each song can be practiced in Smart Learning mode.

1. Press the [SONG] button.
Enter the song selection mode. It will play all songs circularly.
2. Select a song.
Use the data dial or the [+ / YES] / [- / NO] button to select the song you want to play.
3. Press the [START / STOP] button.
Once you start playing a song, it will play current song repeatedly.
4. While stop playing a song, press any of [STYLE] or [VOICE] button, you can exiting the song mode.

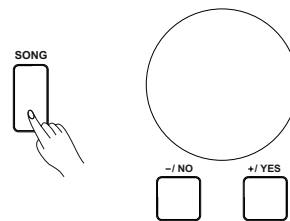

Record

You can record your performance and the accompaniment; this instrument can record up to 5 user songs.

1. Press and hold the [SHIFT] button, and then press the [BANK / RECORD] button.
Enter the song mode, you can use the data dial or the [+ / YES] / [- / NO] button to select a user song to be saved.
2. Press and hold the [SHIFT] button, and then press the [BANK / RECORD] button.
Enter the record standby mode, and you can select voice, style or other parameters to prepare for recording.
3. Press the [START / STOP] button or play a key on the keyboard to start recording.
4. When recording is in process, holding down [SHIFT] button and then press the [RECORD] button, it will stop recording and enter the Song play mode, and the current recorded song will play automatically in circle.

Note:

Press the [SONG] button to enter the song mode and it will play all songs circularly. Use the data dial, [+ / YES] or [- / NO] button can select a user songs (151~155). If there is no data in the selected user song, it will display "NoFile!" and stop playing.

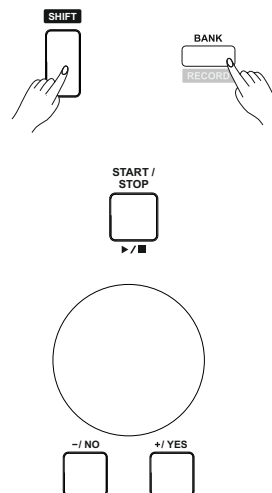

Playing Voices

The instrument features 618 build-in voices (Please refer to Voice List). In order to offer you a better performance experience, we programmed many useful effects which can be inserted while playing voices.

Selecting a Voice

1. Press the [VOICE] button or Voice Direct Button.
Enter the VOICE mode. LCD shows "VOICE R1" and the current voice name and voice number.
2. Select a voice.
Use the data dial, the [+ / YES] button, the [- / NO] button to select the voice you want to play. You can also use the Voice Direct Button to select a voice.
3. Play the voice.
You can play the keyboard and listen to the wonderful voice.

Note:

1. While changing a voice, pay attention to the rules: If you press the same button, the voice will be changed between the upper and lower key. When the upper/lower voice is on, and then you press another direct button, the corresponding upper/lower voice will be selected.
2. When the DUAL and LOWER function is on, you can press [VOICE] button repeatedly to choose the voice source. The corresponding LCD indicate will highlight between R1, R2, and L.

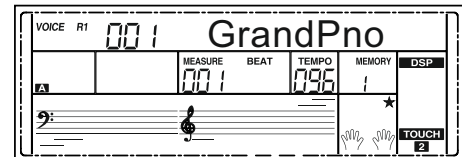
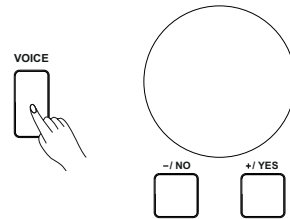

Playing two voices simultaneously-DUAL

This instrument has a dual voice function. This function is capable to enhance the delicacy of your music by playing two voices of musical instruments simultaneously; new combinations of voices and music could be created then. When the dual function is off, the voice indicated is VOICE 1, when the dual function is on; the voice indicated is VOICE 2.

1. In idle mode, press the [DUAL] button to turn dual function on. The LCD displays the current voice name and number, and the indicate "VOICE R 2" and "DUAL".
2. You can use the data dial or [+ / YES] / [- / NO] button to select the dual voice you want to play. You can also use the Voice Direct Button to select a voice.
3. Play the keyboard, and then you will hear two different voices are sounded simultaneously in a layer. It seems like two different instruments playing at the same time.
4. Press the [DUAL] button again to turn the dual function off.

Note:

When the keyboard has been split, only the right hand area will respond the dual voice, the left hand will not respond to it.

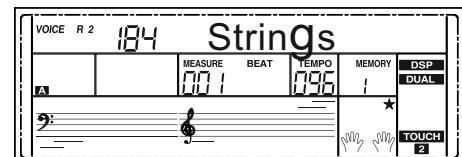
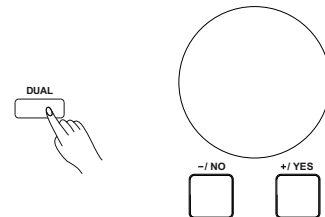

Playing Different Voices with Both hands-LOWER

The lower function splits the keyboard into right and left areas to create two different voices. The left section voice is lower voice. You can set the split point position as you like.

1. In idle mode, press the [LOWER] button to turn the lower function on.
The keyboard is split into two independent sections, and each section has its voice. The LCD displays the left hand voice name and number, and the indicate "VOICE L" and "LOWER".
2. You can use the data dial or the [+ / YES] / [- / NO] button to select the lower voice you want to play. You can also use the Voice Direct Button to select a voice.
3. Play the keyboard in different sections, and you will hear two different voices.
4. Press the [LOWER] button again to turn lower function off.

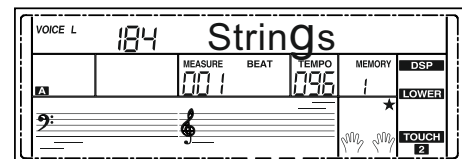
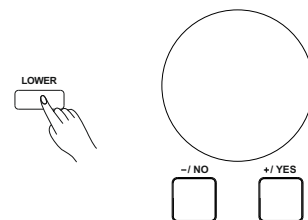

Split Point

The Point on the keyboard that separates voice L and voice R1/R2 is called the "split point". The split point is set to F#3(34) at the factory setting. However you can set this to any key you want. Refer to setting the split point.

Playing Voices

Touch

The instrument is equipped with a touch response feature that lets you dynamically and expressively controls the level of the voice with your playing strength just as on an acoustic instrument. The piano has 3 touch types to choose.

1. Holding down [SHIFT] button and then press [TOUCH] button to enter touch settings. The LCD displays the touch setting number. The default number is 2.
2. Choose a touch type. When the LCD displays touch setting, using [+ / YES] / [- / NO] or data dial or holding down [SHIFT] button, and then pressing [TOUCH] button can change touch type. Pressing [+ / YES] and [- / NO] buttons simultaneously will set touch value to default setting: 2(normal).
3. Turn the touch function off. If the value is set to OFF, that means no touch response to keyboard.

Sustain

1. Press and hold the [SHIFT] button and then press the [SUSTAIN] button to start sustain function. All notes will sustain even after releasing the keys.
2. To stop the sustain function, press the [SUSTAIN] button again.

Note:

If you want a better sustain effect, we recommend you using a sustain pedal. (Refer to pedal function for more details.)

Pitch Bend

Use the pitch bend wheel to bend notes up (roll the wheel away from you) or down (roll the wheel toward you) while playing the keyboard. The pitch bend wheel is self-centering and will automatically return to normal pitch when released. You can use the pitch bend wheel to imitate the guitar, violin, saxophone, urheen, suona and other instruments pitch bend effect, make your performance more vivid.

Modulation

The Modulation function applies a vibrato effect to notes played on the keyboard. This is applied to all the keyboard parts. Pressing the [MODULATION] button to add modulation effect and releasing [MODULATION] button to stop modulation effect. This modulation effect is very important to those performances with urheen, guitar, and violin these string instruments, make your performance more vivid.

Transpose

Transpose function allows the overall pitch of the instrument to be transposed up or down by a maximum of one octave in semitone increments.

1. Holding down [SHIFT] button, and then press [TRANPOSE] button to enter transpose settings. LCD displays the current transpose: xxx Transpos.
2. When LCD displays the current transpose, use [+ / YES] / [- / NO] or data dial to change transpose value. The max transposes is ± 12 semitones.
3. Press [+ / YES] and [- / NO] simultaneously will set the transpose value to its default setting: 000 Transpos.

Note:

1. If you want to play song in G key, you can set the transpose to -05 or 007, and then you can play the G scale using C scale keys.
2. Transpose setting is applied to all part of the music and keyboard.

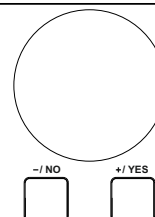
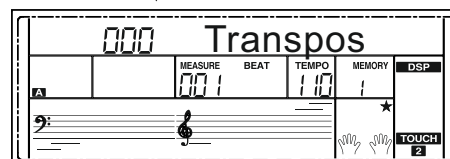
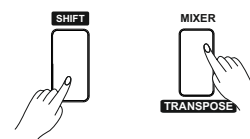
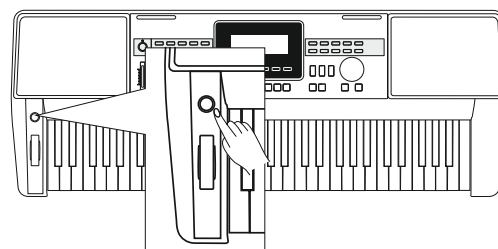
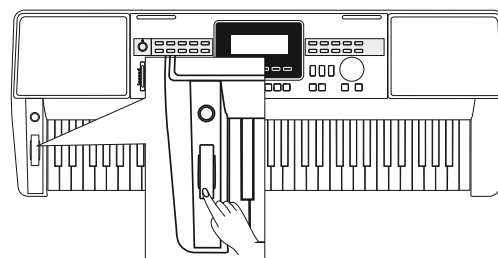
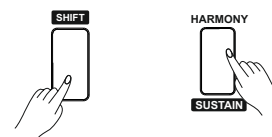
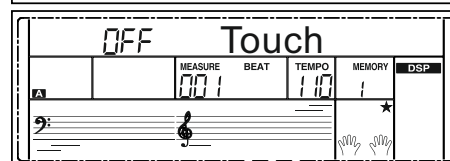
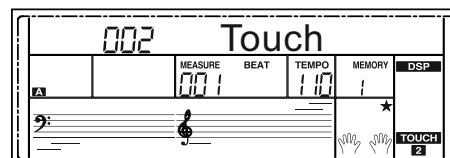
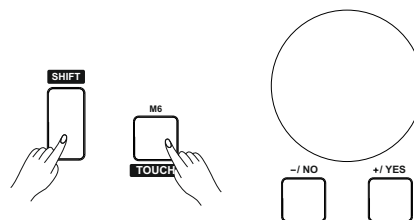

Octave

Octave function determines the relative octave setting for the keyboard-played voice R1, R2 and L.

1. Press and hold the [SHIFT] button and then press the [OCTAVE] button to select octave function menu. The LCD displays “xxx Octave”.
2. When LCD displays the current octave, use [+ / YES] / [- / NO] button or data dial to change octave value, adjustable range is: -1 ~ +1.
3. Press the [+ / YES] and [- / NO] buttons simultaneously to restore default setting: 000.

Note:

1. Some voices have a pitch limit which highest and lowest notes do not sound.
2. You can individually set the octave value of master voice, dual voice and lower voice. For example, in dual mode, allow the pitch of the keyboard to be shifted down or up in octave steps.

Piano mode

This function is to set the voice of the whole keyboard to piano instantly.

1. Press [PIANO] button can enter or exit piano mode.
2. In piano mode, the accompaniment control is the same to other mode. The accompaniment only plays the rhythm part.

Note:

In piano mode, the A.B.C. is automatically turned off.

Metronome

The metronome provides a click sound, giving you an accurate tempo guide when you practice, or letting you hear and check how a specific tempo sounds.

1. Press [METRONOME] button to start the metronome.
2. To stop the metronome, press the [METRONOME] button again. (The metronome type can be set in the function menu.)

Note:

1. The metronome and style can be started at the same time. If you start the metronome after the style stop playing, the beat type will be changed as metronome setting; if you start the metronome while the style is playing, the beat type will be changed as style setting.
2. You can record your performance while playing back the metronome. However, the metronome sound is not recorded.

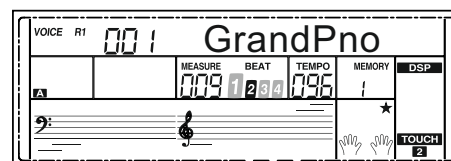
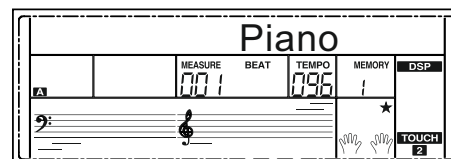
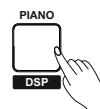
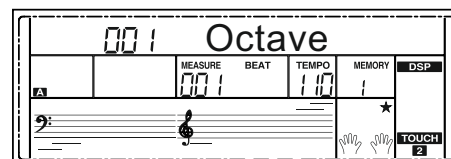

Auto Accompaniment

The auto accompaniment feature puts a full backing band at your fingertips. To use it, all you have to do is to play the chords with your left hand using your selected accompaniment style, and then the accompaniment will automatically play along, instantly following the chords you play. With auto accompaniment, even a solo performer can enjoy playing with the backing of an entire band or orchestra. This keyboard features 200 styles in a variety of musical genres. Try to select some of the different styles (refer to Style List) and enjoy the auto accompaniment feature.

Play Auto Accompaniment (rhythm track only)

1. Press [STYLE] button.
Enter the style mode. The "STYLE" icon on the left-top of the LCD will light up. The LCD displays the name and number of the current style.
2. Select a style.
Use the data dial or the [+ / YES] / [- / NO] button to select a style you want to play. Or you can use the Style Direct Button to make a quick selection.
3. Start playing a style.
Press the [START/STOP] button to start the rhythm tracks of the auto accompaniment. Also you can press [SYNC START] and then play any key to start the rhythm tracks of the auto accompaniment.
4. If you are ready to stop playing style, press the [START/STOP] again.

Note:

While changing a style, pay attention to the rules. If the same button has been pressed twice, the style will be swapped from one to another. When the upper/lower style is on, and you then press another direct button, the corresponding upper/lower style will be selected.

Play Auto Accompaniment(all tracks)

1. Turn the auto accompaniment on.
In style mode, you can press the [CHORD MODE] button to enter the "auto bass chord" (A.B.C.) mode. The keyboard is split into two sections. Left hand section is chord detect section. The "A.B.C." icon will light up. Now pressing any key in chord detect section(Sync Start status)you will hear the fantastic accompaniment.
Press [CHORD MODE] button again to enter "full range" mode. The "FULL RANGE" icon will light up. The whole keyboard is chord detect section.
2. Start the auto accompaniment.
You can press [SYNC START] button and then play a chord in chord detect section to start auto accompaniment of all tracks. When you change a chord, the accompaniment automatically changes.
You can also press [START/STOP] button to start auto accompaniment of rhythm track, then play a chord in chord detect section. It will start auto accompaniment of all tracks.

Note:

The instrument can save 10 user styles. To use your styles, you should use an optional Software to convert the style, and then use the USB cable to save the styles to the instrument.

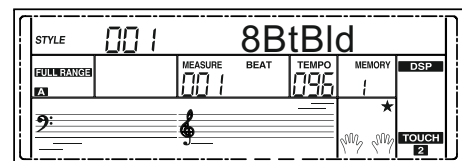
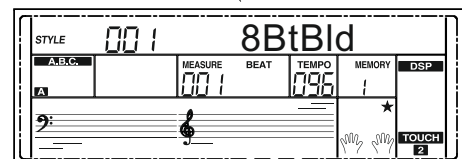
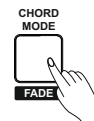
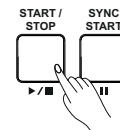
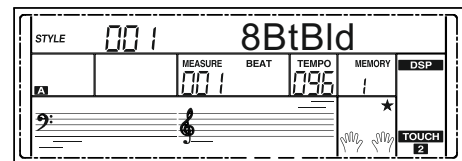
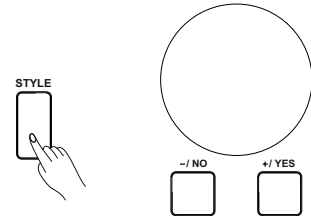

Accompaniment Sections

There are various types of Auto Accompaniment sections that allow you to vary the arrangement of the accompaniment to match the song you are playing. They are: Intro, Main (A, B), Fill (A, B), and Ending. By switching among them during your performance you can easily produce the dynamic elements of a professional sounding arrangement in your performance.

1. INTRO Section

The intro is an opening section of the song.

Each preset style features two different patterns. When the intro pattern finished, the system will automatically shift to the main section.

2. MAIN Section

The main is an important section of the song. And it plays an accompaniment pattern and repeat infinitely until another section's button is pressed.

3. FILL IN Section

Auto fill in function automatically adds a fill to your performance. When the fill-in is finished, accompaniment shifts to the Main section (A,B).

4. ENDING Section

Ending is used for the ending of the song. When the ending is finished, accompaniment automatically stops. The length of the ending differs depending on the selected style.

Note:

1. Holding down the [FILL A]/ [FILL B] button when the style is playing, the selected fill-in pattern repeats continuously until button is released.
2. Press [FILL A]/ [FILL B] button when style stops, it will change to the normal section.

Playing Different Accompaniment Sections

1. Press the [STYLE] button. Press the Style Direct Button, data dial or [+ / YES] / [- / NO] button to select a style.
2. Press [CHORD MODE] button to enter A.B.C. (auto bass chord) mode.
3. Press [SYNC START] button.
4. Press the [FILL A] button, select the Main A section.
5. Press the [INTRO/ENDING] button. Now the "A" indicate on LCD, and the style is ready to play.
6. It will start the accompaniment as soon as you start playing in Chord section. When the playback of the intro is finished, it automatically leads into Main A section.
7. Press the [FILL B] button. A fill-in plays, automatically followed by the Main B section.
8. Press the [INTRO/ENDING] button again, and it will enter the Ending Section. When the ending is finished, the auto accompaniment automatically stops.

Fade

1. Fade In

Starting the style with fade in produces a smooth beginning, the volume increases from low to high. Press and hold the [SHIFT] button and then press the [FADE] button when Style playback is stopped. The "▲FADE" icon will be lighting up, and then flashing with style playing.

2. Fade Out

Stopping the style with fade out produces a smooth ending, the volume increases from high to low. Press and hold the [SHIFT] button and then press the [FADE] button during Style playback. The "FADE ▾" icon will be lighting up, and then flashing with style playing.

3. Fade In/ Out Time

The default time value is 10 seconds.

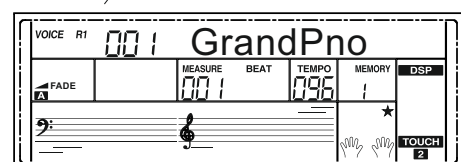
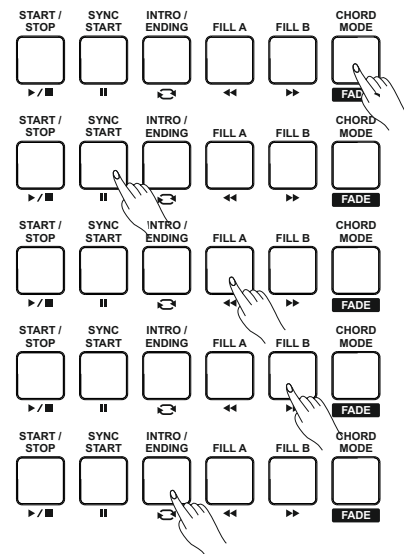
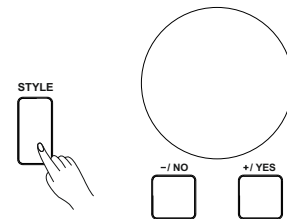
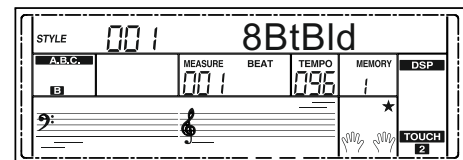
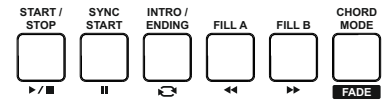

Auto Accompaniment

Accompaniment Volume Control

Adjust the master accompaniment volume; you can use this function to balance auto accompaniment part volume and keyboard voice volume.

1. Press and hold the [SHIFT] button, and then use the [ACCOMP +]/[ACCOMP -] button to set accompaniment volume, adjustable range: 0~127, the LCD displays current accompaniment volume value.
2. Press and hold the [SHIFT] button and then press the [ACCOMP +]/[ACCOMP -] for a while you can quickly adjust the volume value.
3. Press and hold the [SHIFT] button, at the accomp volume temporarily showed on the LCD, press the [ACCOMP +]/[ACCOMP -] button simultaneously to turn the accompaniment volume off. The LCD displays "OFF Accomp". Keep the [SHIFT] button pressed and then press the [ACCOMP +]/[ACCOMP -] button again to turn the accompaniment volume on.

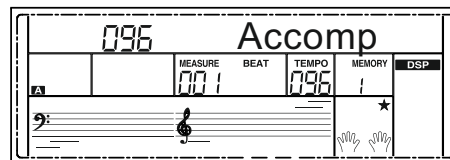
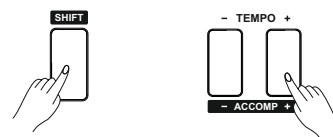

Chord Fingering

How the chords are played or indicated with your left hand (in the auto accompaniment section of the keyboard) is referred to as "fingering". There are 2 types of fingerings as described below.

Chord Basics

A chord, in music, is any harmonic set of three or more notes that is heard as if sounding simultaneously. The most frequently encountered chords are triads. A triad is a set of three notes that can be stacked in thirds. When stacked in thirds, the triad's members, from lowest pitched tone to highest, are called: the Root, the Third, and the Fifth.

Triad Type

There are following basic triad types:

Major Triad	A root with a major third added above and a perfect fifth will consist as a "Major Triad".
Minor Triad	A root with a minor third added above and a perfect fifth will consist as a "Minor Triad".
Augmented Triad	A root with a major third added above and an augmented fifth will consist as an "Augmented Triad".
Diminished Triad	A root with a minor third added above and a diminished fifth will consist as a "Diminished Triad".

Chord Inversion

We define this chord its root is not in the bass (i.e., is not the lowest note) as an inversion chord. When the root is in the bass, we call the chord: root-position chord. If we put the Third and Fifth in the root position, then it forms "Inversion", we call this chord "Inversion Chord". See the following major triad and its inverted chord.

Chord Name

The chord name contains two parts content: Chord root and Chord type.

Single Finger

Single finger type not only can detect single finger but also can detect multi finger. And the single finger makes it easily to play chords through only one, two or three keys. Including major, minor, seventh, and minor seventh chord. Refer to relevant picture on the right for details.

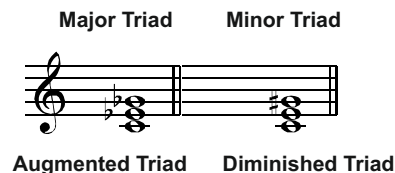
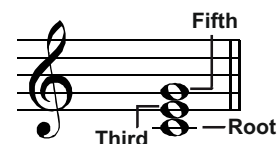

Root Position First Inversion Second Inversion

Cm

Chord Root Chord Type

C		★ Major Triad Only press the root note on the keyboard.
Cm		★ Minor Triad Press the root note and the nearest left black key simultaneously.
C7		★ Seventh chord Press the root note and the nearest left white key simultaneously.
Cm7		★ Minor seventh chord Press the root note and the nearest left white and black keys simultaneously.

Multi Finger

Multi finger type only can recognize those chords have listed in the chord list, and also can be found in the dictionary function.

Note:

In full range mode, the entire keyboard will only recognize chords played in normal fingering.

0 C	1 C ₆	2 C _{M7}	3 C _{M7} (#11)	4 C _M (9)	5 C _{M7} (⁹)
6 C ₆ (⁹)	7 C _{aug}	8 C _m	9 C _m ₆	10 C _{m7}	11 C _{m7} (^{b5})
12 C _m (⁹)	13 C _{m7} (⁹)	14 C _{m7} (¹¹)	15 C _m ₇	16 C _m ₇ (⁹)	17 C _{dim}
18 C _{dim} ₇	19 C ₇	20 C ₇ _{sus4}	21 C ₇ (^{b5})	22 C ₇ (⁹)	23 C ₇ (^{#11})
24 C ₇ (¹³)	25 C ₇ (^{b9})	26 C ₇ (^{b13})	27 C ₇ (^{#9})	28 C _{M7} _{aug}	29 C ₇ _{aug}
30 C _{sus4}	31 C ₁₊₂₊₅	Notes enclosed in parentheses are optional; the chords could be recognized without them.			

Tempo

Each style of the instrument has been set with a default or standard tempo; however, this can be changed by using the [TEMPO +]/[TEMPO -] button.

1. Use the [TEMPO +]/[TEMPO -] button to change the tempo. While the tempo data is flashing, use the data dial can also change the tempo.

2. Press the [TEMPO+] and [TEMPO-] buttons simultaneously to restore the default tempo setting.

Note:

The tempo will change when changing the style not playing the accompaniment. The tempo will not change when changing the style playing the accompaniment.

One Touch Setting

Sometimes it is difficult to pick up an appropriate voice to playing a song, but One Touch Setting Function can make it easy to get a perfect choice. When One Touch Setting is switched on, you can instantly recall all auto accompaniment related settings including voices selection and digital effects simply with a single touch of a button.

1. Press the [O.T.S.] button to turn on the One Touch Setting for current style. The LCD displays "O.T.S. ".

2. Press one of the One Touch Setting buttons [M1]-[M4]. Various panel settings (such as voice, effect, etc.) that match the selected style can be instantly recalled with just a single button press.

One Touch Setting parameter list:

Part ON/OFF (VOICER1, R2, L)
 Voice Change (VOICER1, R2, L)
 Voice Volume (VOICER1, R2, L)
 Voice Reverb Level (VOICER1, R2, L)
 Voice Chorus Level (VOICER1, R2, L)

Note:

1. The O.T.S. automatically turned off when you enter the song mode.
2. In O.T.S. mode, the memory cannot be registered.

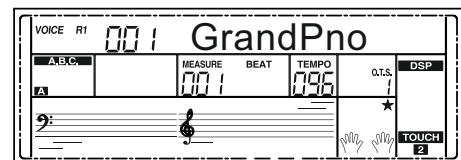
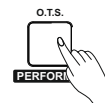
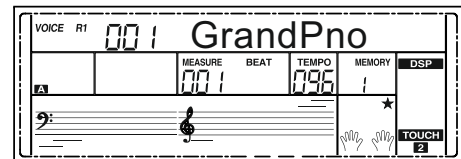
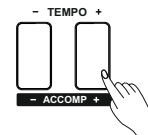

Harmony

The harmony function can add harmony effect to the main voice. If you turn the harmony on, the harmony function will automatically add harmony notes to the notes played in the right-hand section, which gives you a rich and harmonic expression.

Harmony Switch

1. Press [HARMONY] button. The LCD displays "OFF", which indicates the harmony effects turned off now.
2. When the LCD displays "OFF", repeat the previous operation. The LCD now displays "Hrm Duet", which indicates the harmony effect is open, and the type is Duet.
3. To choose a different harmony type, please refer to the harmony setting in function menu.

Play with harmony effect

Open the A.B.C., first play a chord, and then play notes in right hand section, the notes played in main voice will be added with the harmony effect.

Note:

The harmony types of 1+5, Octave 1~2, Echo 1~4, Tremolo 1~4 and Trill 1~4 will respond whether the A.B.C. is open or not. Other types of harmony will respond only when the A.B.C. is open.

HARMONY

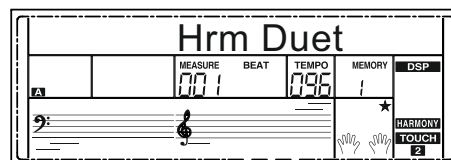
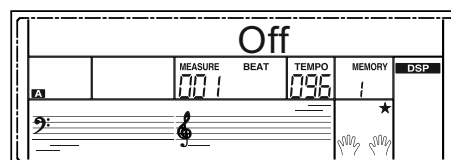

Performance Assistant

There are 2 voices you can select to perform in performance assistant mode: Guitar and Piano.

What's the performance assistant?

Performance assistant is an easy-to-use function. With this function you will find playing to be more interesting. Even if you are not a keyboard player, the performance assistant will help you to play your familiar instrument voice on the keyboard. If you're a pianist, you can easier to achieve many hard perform skills on the keyboard with the help of this function. Performance assistant will provided many wonderful phrases. Just use several keys and you will perform your own wonderful music.

Enter the Performance Assistant

1. Holding down [SHIFT] button, and then press [PERFORM] button you can enter the performance assistant mode. The default setting is Guitar Mode and the LCD will display Guitar's voice name.
2. You can use the Data Dial, [+ / YES] or [- / NO] button to change the voice you want to perform.
3. In the measure field in LCD, the "4-4" will be displayed. It means the default beat value is the 4/4 and you can change the beat value you want in function menu. Please refer to Performance Beat setting in function menu.
4. You can choose the beat between 2/4, 3/4, 4/4, and 6/8 beat.
5. In Performance Assistant mode, use [TEMPO+] or [TEMPO-] to change the tempo.

Guitar Mode

Guitar key map

The Guitar Mode makes you perform a guitar voice with keyboard just like you're playing a real guitar. In this mode you can use some perform skills like strum (5), broken chord (5), echoism (5) and also 2 endings.

Chord part

C2 to B3 is the chord part area. Play a chord in this area.

Sub Area 1

C4 to B4 (only white keys) is the sub area 1. 5 types of broken chord are provided in this area.

Sub Area 2

The 6 keys: C5 to A5 (only white keys) is just like real guitar's 6 strings. Play a free solo in this area.

Rhythm Area

C6 to G6 (only white keys) is the rhythm area. Wonderful styles and strums are provided in this area. Use A6 to B6 to play an ending.

Position Change

Press C7, the LCD highlight the performance assistant high cursor, repeatedly press the C7 key change the guitar voice between a high and a low position.

Note:

The keys above C7 don't respond in this mode.

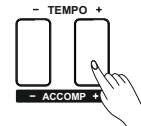
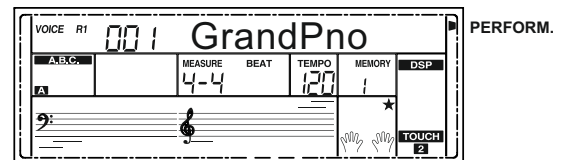

Guitar mode key map

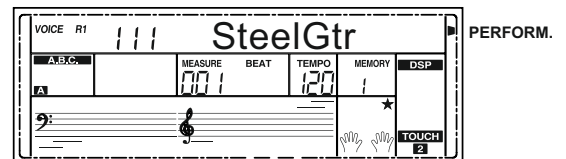
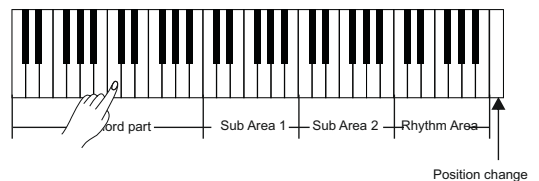

Playing in Guitar Mode

Play a chord in the chord part.

A chord type will be displayed on the LCD and the guitar root note will be sounded.

Play a broken chord in the sub area 1.

When the chord type displayed, press a white key in the sub area 1, a wonderful broken chord phrase will start. Try to change the white key and you will hear some different type of phrase. Change the chord with your left hand; you will hear the broken chord phrase has a little bit change.

Play a free solo in the sub area 2.

When the chord type displayed, press a white key in the sub area 2 you can play guitar free solo, sounds like you're playing a real one. Try to change the chord with your left hand, and play your free solo. The last white key B5 is invalid.

Play a strum rhythm in the rhythm area.

When the chord type displayed, press a white key in the rhythm area you can play the magic strum rhythm. Try to change the chord with your left hand, and play your strums.

End the guitar performing.

Press the A6 or B6 to end your guitar performs. When the ending is finished, the phrase stops automatically.

Play the echoism.

All of black keys on Sub area 1, Sub area 2 and Rhythm area are echoism keys. There are 5 kinds of echoism to arrange on the C#, D#, F#, G#, A# circularly.

Change the position

Press the C7, the PERFORM.H icon will be lightened on the LCD. It means that the guitar position has been changed to the High position. Try to play the white keys in sub area 1, Sub area 2 and Rhythm area, listen to the phrase you are performing now.

Guitar mode key map

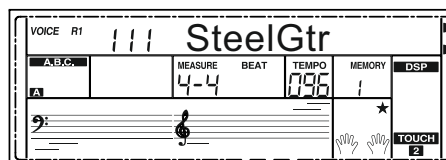
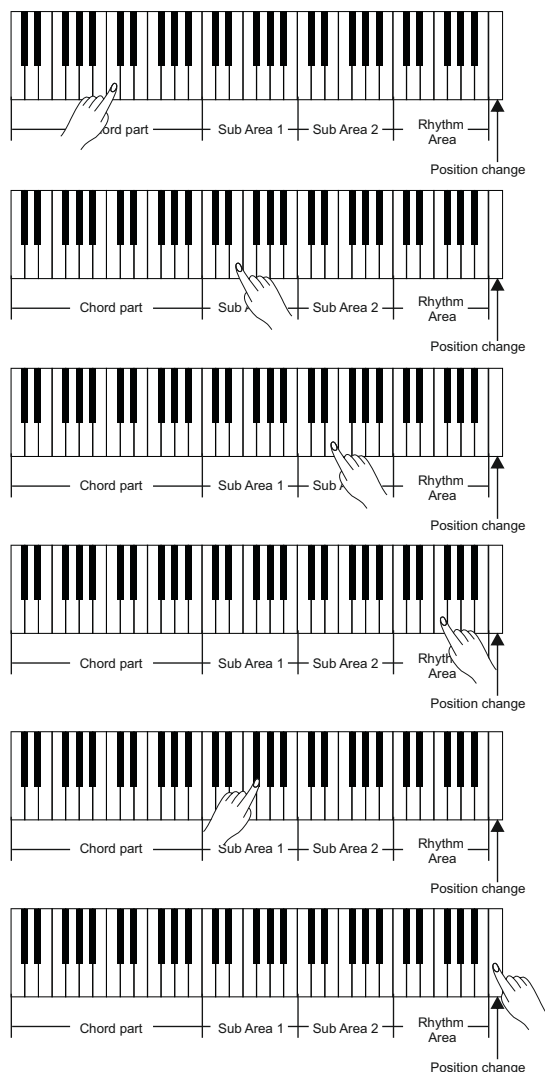

PERFORM.
PERFORM. H

Piano Mode

Piano Key Map

In Piano Mode, you can easily to achieve many hard piano perform skills just like playing the acoustic one. In this mode you can use some perform skills like piano rhythm (5), broken chord (5) and also 3 endings.

The piano key map is similar with the guitar key map. Press A6 to C7 (white keys) will start an ending. All the black keys above C4 are invalid.

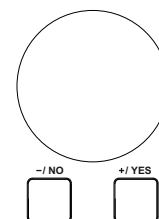

Playing in Piano Mode

1. Select Piano Mode.
In performance assistant mode, use data dial, [+ / YES] or [- / NO] button to select Piano Mode.
2. Play a chord in chord part. Play some phrases in Sub area and Rhythm area.
3. Press the A6, B6 or C7 to ending your piano perform. When the ending is finished, the phrase stops automatically.

Exit the Performance Assistant

When the phrase stops, press the [VOICE], [STYLE], [SONG], [DEMO], [SHIFT] + [PERFORM] to exit the Performance Assistant mode.

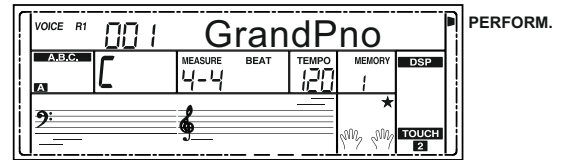
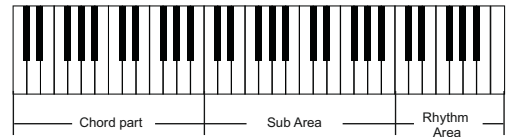

DSP

The DSP is a simulate sounds of sound localization technology in the real environment. Since each sound should be produced in a certain space, so when you at home, in cinema or in the wilderness, even play the same violin you can hear different sounds, the difference sounds are caused by different atmosphere. The DSP effect is set to ON and the icon on the LCD is lighten when keyboard is power on. Holding down [SHIFT] button and then press the [DSP] button to turn the DSP effect on or off. Refer to Function Menu for further editing effect type and depth.

Note:

It may cause a break or a noise while switching on/off the DSP when style and song playing. This is normal and need not panic.

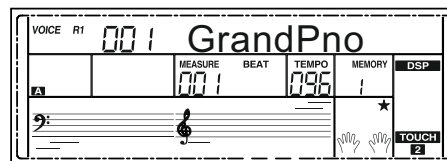

Mixer

Mixer function can control the volume of different tracks. It just likes a mini type mixing controller, separately control the left/right hand track volume, bass track volume, and rhythm track volume and so on.

1. Press the [MIXER] button to enter the mixer function menu, the LCD displays current rhythm volume value for the first time when powered on; after then it will keep your last options every time.
2. Repeatedly press the [MIXER] button to select one that you want to set.
Use [+ / YES] / [- / NO] button or data dial to change parameters.

The option and parameters are as follows:

Content	LCD Display	Range
Adjust the Percussion track volume.	XXX Rhythm_s	0 - 127
Adjust the Rhythm track volume.	XXX Rhythm_m	0 - 127
Adjust the Bass track volume.	XXX Bass	0 - 127
Adjust the Chord 1 track volume.	XXX Chord1	0 - 127
Adjust the Chord 2 track volume.	XXX Chord2	0 - 127
Adjust the Chord 3 track volume.	XXX Chord3	0 - 127
Adjust the Phrase 1 track volume.	XXX Phrase1	0 - 127
Adjust the Phrase 2 track volume.	XXX Phrase2	0 - 127
Adjust the Upper 1 track volume.	XXX Upper 1	0 - 127
Adjust the Upper 2 track volume.	XXX Upper 2	0 - 127
Adjust the Lower track volume.	XXX Lower	0 - 127

Note:

The function menu status will exit if no operation is done within 5 seconds.

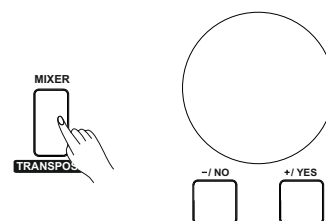

Pedal Function

Using pedal function can makes your performance more naturally and with greater expressiveness.

You can refer to Pedal Type chapter for details.

1. Sustain Pedal

This pedal function performs the same function as the damper pedal on an acoustic piano, letting you sustain the sound of voices even after releasing the keys.

Step and press on the pedal to turn the sustain effect on.

Release the pedal to turn the sustain effect on.

2. Soft Pedal

When the soft pedal is selected, pressing this pedal and makes them (the notes you play) sound softer.

3. Style Start/Stop Pedal

When the style start/stop pedal is selected, pressing this pedal to start/stop accompaniment.

4. Memory Pedal

When the memory pedal is selected, pressing this pedal at the first time to call up register memory: M1, and then you can call up register memory M2, M3...by pressing this pedal step by step (There are 48 memories).

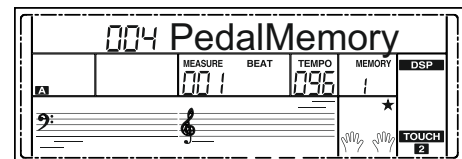
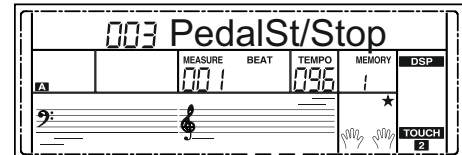
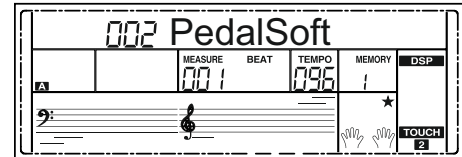
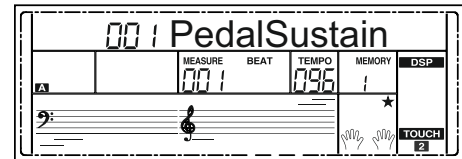

Function Menu

Press the [FUNCTION] button to enter function menu. The LCD displays the current function menu option. Use [+ /YES] / [- /NO] button or data dial to set parameter of the current menu.

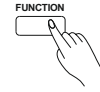

The option and parameters are as follows:

NO.	Content	LCD display	Range	Default
1	Tune	xxx Tune	-50 ~ +50	000
2	Key Split	xxx KeySplit	1~61	019
3	Beat Type	xxx BeatType	0, 2 ~ 9	004
4	Metronome Volume	xxx MetroVol	0~127	80
5	Pedal Type	xxx Pedal xxxx	Sustain, Soft, St/Stop, Memory	Sustain
6	EQ Type	xxx EQ xxx	Pop, Rock, Class, Jazz, Dance, Reset	Reset
7	Reverb Type	xxx Rev xxxxx	Room1, Room2, Room3, Hall1, Hall2, Hall3, Church1, Church2, Delay, PanDelay	RevHall1
8	Reverb Level	xxx ReverbVol	0 ~ 127	70
9	Chorus Type	xxx Chr xxxxx	Chorus1, Chorus2, GM Chorus1, GM Chorus2, Flanger1, Flanger2, Rotary1, Rotary2	GMChorus2
10	Chorus Level	xxx Hrm xxxxx	0 ~ 127	0
11	Harmony Types		Duet, StandardTrio, Full Chord, Rock Duet, Country Duet, Country Trio, Block, 4 Close 1, 4 Close 2, 4 Open, 1+5, Octave1, Octave2, Strum, Echo1, Echo2, Echo3, Echo4, Tremolo1, Tremolo2, Tremolo3, Tremolo4, Trill1, Trill2, Trill3, Trill4	HrmDuet
12	MIDI Receive	xxx Midi In	1 ~ 16, ALL	ALL
13	MIDI Transmit	xxx Midi Out	1 ~ 16	001
14	Auto Power Off	xxx PowerOff	OFF, 30, 60	030
15	Performance Beat	xxx Perform Beat	4-4, 3-4, 2-4, 6-8	4-4

Note:

The function menu status will exit if no operation is done within 5 seconds.

Tune

This function sets the pitch of entire keyboard by steps of cents.

1. Repeatedly press the [FUNCTION] button to select the tune menu. The LCD displays "xxx Tune". Use [+ /YES] / [- /NO] button or data dial to change tune value. Its range is from -50 to 50 cents.

2. Press [+ /YES] and [- /NO] buttons simultaneously will set the tune value to its default setting: 000. The setting is applied to both accompaniment and the voice.

Key Split

The Point on the keyboard that separates voice L and voice R1/R2 is called the "split point". Left hand section controls the auto bass chord accompaniment when the A.B.C. function is on, or it can be used to play the lower voices when the A.B.C. function is off.

1. Repeatedly press the [FUNCTION] button to select split point menu. The LCD displays "xxx KeySplit" currently. Use [+ /YES] / [- /NO] button or data dial to change Split Point. The range of Split Point is: 1~61, press the [+ /YES] and [- /NO] buttons to restore its default setting.
2. Press [+ /YES] and [- /NO] buttons simultaneously will set the split point value to its default setting: F#3 (19).

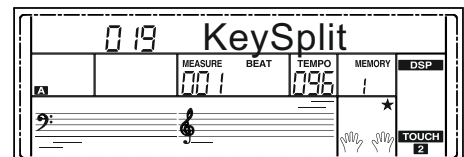
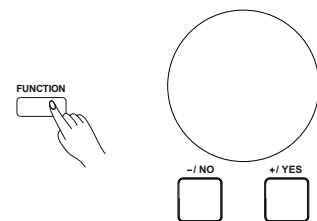
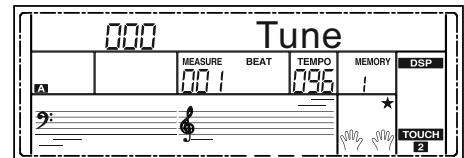
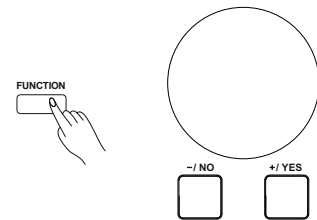

Beat Type

1. Repeatedly press the [FUNCTION] button to select beat type menu. The LCD displays “xxx BeatType”. Use [+ /YES] / [- /NO] button or data dial to change beat type. The range of beat type: 0, 2~9.
2. Press [+ /YES] and [- /NO] buttons simultaneously will set the beat type value to its default setting: 004.

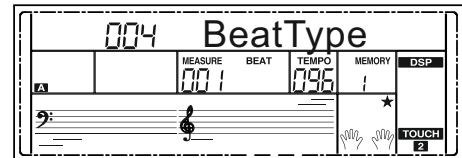
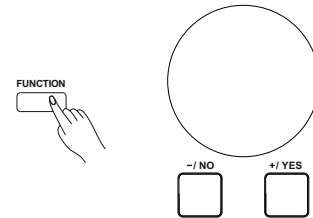

Metronome Volume

1. Repeatedly press the [FUNCTION] button to select metronome volume menu. The LCD displays “xxx MetroVol”. Use [+ /YES] / [- /NO] button or data dial to adjust metronome volume value. The range of metronome value is: 0 ~ 127.
2. Press [+ /YES] and [- /NO] buttons simultaneously will set the metronome volume value to its default setting: 080.

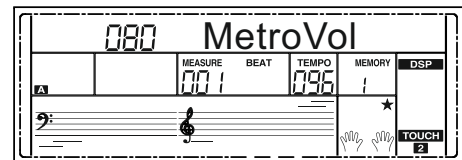
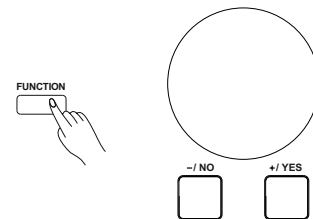

Pedal Type

1. Repeatedly press the [FUNCTION] button to select pedal type menu. The LCD displays “00x Pedal xxxx”. Use [+ /YES] / [- /NO] button or data dial to change pedal type. There are 4 types of pedal are available.
2. Press [+] and [-] buttons simultaneously will set the pedal type to its default setting: 001 PedalSustain. The pedal types are as follows:

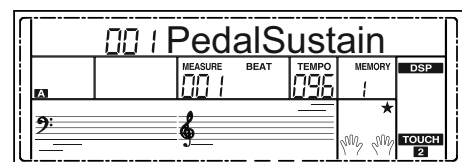
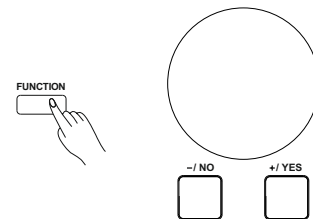

No.	LCD	Pedal Function
1	PedalSustain	Sustain Pedal
2	PedalSoft	Soft Pedal
3	PedalSt/Stop	Start/Stop Pedal
4	PedalMemory	Memory Switch Pedal

EQ Type

Equalizer is a sound processor that can be used to adjust gain value of each frequency band of sound, different gain value setting can make a different sound field effect. You can select one of the 6 preset EQ settings in the EQ display.

1. Repeatedly press the [FUNCTION] button to select the EQ type menu. The LCD displays “006 EQ Reset”. Use [+ /YES] / [- /NO] button or data dial to change EQ type.
2. Press [+] and [-] buttons simultaneously will set the EQ type to its default setting: 006 EQ Reset.

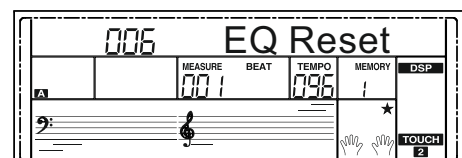
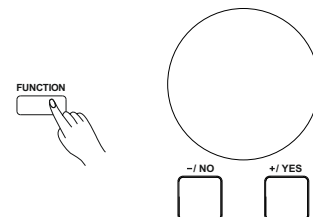

Function Menu

The EQ types are as follows:

No.	LCD	EQ Type
1	EQ Pop	Pop
2	EQ Rock	Rock
3	EQ Class	Classical
4	EQ Jazz	Jazz
5	EQ Dance	Dance
6	EQ Reset	Reset

Reverb Type

1. Repeatedly press the [FUNCTION] button to select reverb type menu. The LCD displays "004 Rev Hall1". Use [+ /YES] / [- /NO] button or data dial to change reverb type.
2. Press [+] and [-] buttons simultaneously will set the reverb type to its default setting: 004 Rev Hall1.

The reverb types are as follows:

No.	LCD	Reverb Type
1	Rev Room1	Room 1
2	Rev Room2	Room 2
3	Rev Room3	Room 3
4	Rev Hall1	Hall 1
5	Rev Hall2	Hall 2
6	Rev Hall3	Hall 3
7	Rev Church1	Church 1
8	Rev Church2	Church 2
9	Rev Delay	Delay
10	Rev PanDelay	Pan Delay

Reverb Level

1. Repeatedly press the [FUNCTION] button to select reverb level. The LCD displays "xxx Reverb Vol". Use the [+ /YES] / [- /NO] button or data dial to change reverb level, adjustable range is: 0-127
2. Press the [+ /YES] and [- /NO] buttons simultaneously to restore its default setting: 070

Chorus Type

1. Repeatedly press the [FUNCTION] button to select chorus type menu. The LCD displays "004 GM Chorus2". Use [+ /YES] / [- /NO] button or data dial to change chorus type.
2. Press the [+ /YES] and [- /NO] buttons simultaneously to restore its default setting: 004 GM Chorus2.

The chorus types are as follows:

No.	LCD	Chorus Type
1	Chr Chorus1	Chorus 1
2	Chr Chorus2	Chorus 2
3	GM Chorus1	GM Chorus 1
4	GM Chorus2	GM Chorus 2
5	Chr Flanger1	Flanger 1
6	Chr Flanger2	Flanger 2
7	Chr Rotary1	Rotary 1
8	Chr Rotary2	Rotary 2

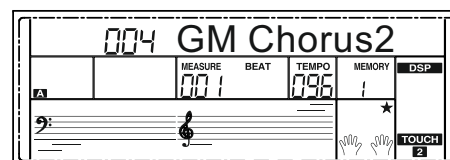
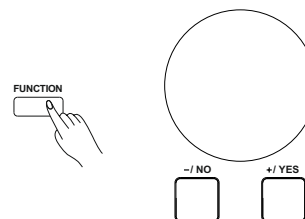
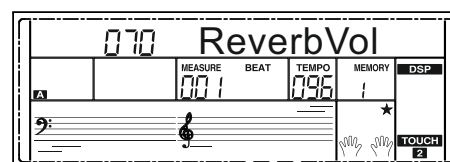
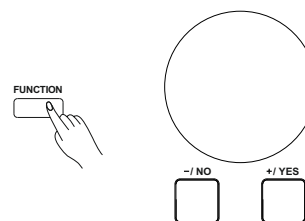
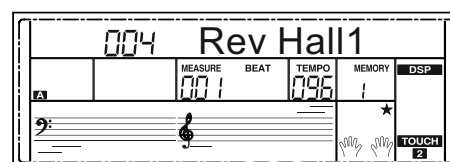
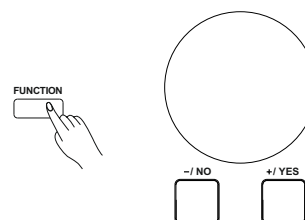

Chorus Level

1. Repeatedly press the [FUNCTION] button to select chorus level menu. The LCD displays "xxx ChorusVol". Use the [+ / YES] / [- / NO] button or data dial to change chorus level, adjustable range: 0-127.
2. Press the [+ / YES] and [- / NO] buttons simultaneously to restore its default setting: 000

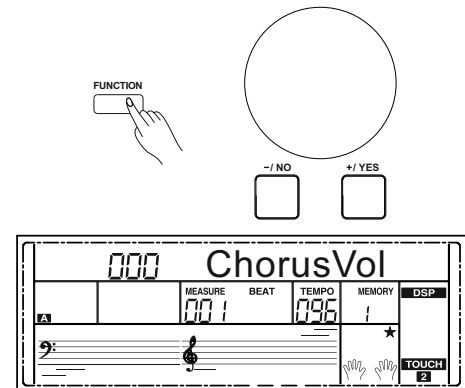

Harmony Type

1. Repeatedly press the [FUNCTION] button to select harmony type menu. The LCD displays "001 Hrm Duet". Use [+ / YES] / [- / NO] button or data dial to change harmony type.
2. Press the [+ / YES] and [- / NO] buttons simultaneously to restore its default setting: 001 Hrm Duet.

The harmony types are as follows:

No.	LCD	Harmony Type
1	Hrm Duet	Duet
2	Hrm StdTrio	StandardTrio
3	Hrm FulChord	Full Chord
4	Hrm RockDuet	Rock Duet
5	Hrm CtryDuet	Country Duet
6	Hrm CtryTrio	Country Trio
7	Hrm Block	Block
8	Hrm 4Close1	4 Close 1
9	Hrm 4Close2	4 Close 2
10	Hrm 4Open	4 Open
11	Hrm 1+5	1+5
12	Hrm Octave1	Octave 1
13	Hrm Octave2	Octave 2
14	Hrm Strum	Arpeggio
15	Hrm Echo1	Echo1
16	Hrm Echo2	Echo2
17	Hrm Echo3	Echo3
18	Hrm Echo4	Echo4
19	Hrm Tremolo1	Tremolo1
20	Hrm Tremolo2	Tremolo2
21	Hrm Tremolo3	Tremolo3
22	Hrm Tremolo4	Tremolo4
23	Hrm Trill1	Trill1
24	Hrm Trill2	Trill2
25	Hrm Trill3	Trill3
26	Hrm Trill4	Trill4

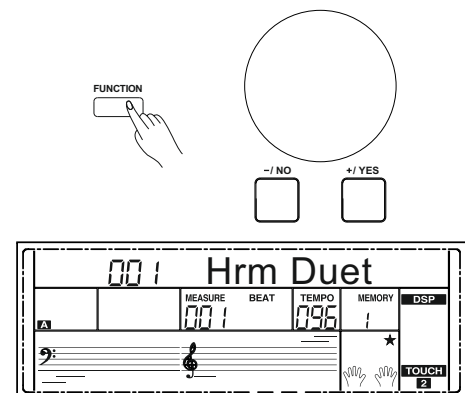

Function Menu

MIDI IN

1. Repeatedly press the [FUNCTION] button to select MIDI in menu. The LCD displays “xxx Midi In”. Use [+ /YES] / [- /NO] button or data dial to change MIDI in channel: 1~16, ALL.
2. Press [+ /YES] and [- /NO] buttons simultaneously to restore MIDI in channel to its default setting: ALL.

MIDI OUT

1. Repeatedly press the [FUNCTION] button to select MIDI out menu. The LCD displays “xxx Midi Out”. Use [+ /YES] / [- /NO] button or data dial to change MIDI out channel: 1~16.
2. Press [+ /YES] and [- /NO] buttons simultaneously to restore MIDI out channel to its default setting: 001.

Auto Power Off

This function is used to set the auto power off time.

1. Repeatedly press the [FUNCTION] button to select auto power off menu. The LCD displays “xxx Power Off”. Use [+ /YES] / [- /NO] button or data dial to change auto power off time: 30 minutes, 60 minutes or OFF.
2. Press [+ /YES] and [- /NO] buttons simultaneously will set the default setting is: 030 (30 minutes).

Performance Beat

This function is used to set the performance assistant beat type.

1. Repeatedly press [FUNCTION] button to select Perform Beat menu. The LCD displays “xxx Perform Beat”. Use [+ /YES] / [- /NO] or data dial to change performance beat: 4-4, 3-4, 2-4, 6-8.
2. Press [+ /YES] and [- /NO] buttons simultaneously will set performance beat channel to its default setting: 4-4.

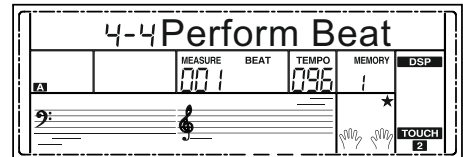
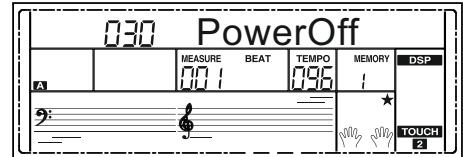
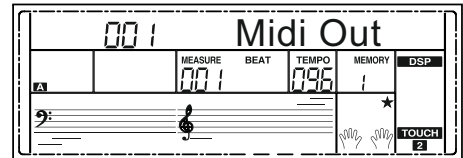
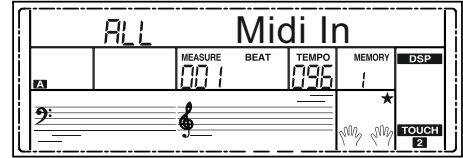
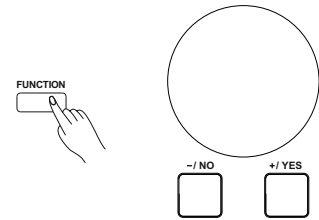

Restore Factory Setting

Pressing and holding [+ /YES] and [- /NO] button together and then turn the power on, the instrument would be restored to factory setting. It will delete all the user data: user styles, user songs and registered memory. The LCD will display “Loading!”. After the restore completed, the instrument will start normally.

Register Memory

The Registration Memory feature can make your performance more easily and efficiently. It allows you to save virtually all panel settings to a Registration Memory setting, and you can instantly recall custom panel settings by pressing a single button.

Registering the Panel Setting

1. There are 8 memory banks, and each bank has 6 memories (M1-M6).
2. Holding down the [STORE] button press one of the registration memory buttons: [M1] - [M6]. Notice that the new settings will replace the previous memory data.

Note:

Press [STORE] and [M1] button then power on, the registration memory will be set to default.

Recalling the Registered Panel Settings

Press one of the registration memory buttons: [M1] - [M6]. In this example, the panel settings stored in the memory 2 of bank 1 are recalled.

Note:

Registration data cannot be recalled when the One Touch Setting function is on.

Selecting a Registration Bank

1. Press the [BANK] button. The LCD will display the number of memory.
2. There are 8 banks in all and each bank has 6 memories (M1-M6). Repeatedly press the [BANK] button to select bank settings.
3. You can save following parameters into M1-M6 registered memory:
 - Voice Parameter:** including voice, dual, lower, DSP, mixer.
 - Accompaniment Parameter:** including style, tempo, and accompaniment no/off.
 - Function Parameter:** including velocity, part parameters in function menu.

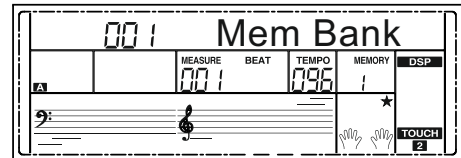
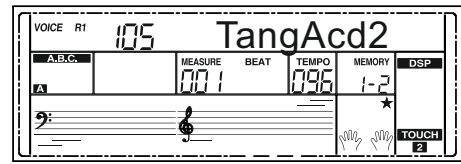
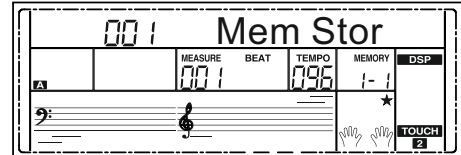
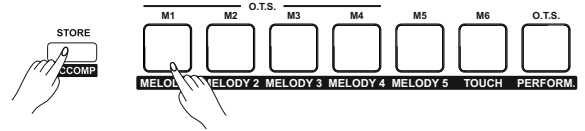

Song Album

The instrument has Song Album function. It presets 310 album songs parameter, which includes style type, tempo, and voice. You can play the preset song using song album function using the parameter in accordance with that song. Please refer to appendix for album list.

1. Holding down [SHIFT] button and then press the [ALBUM] button can turn the album function on or off.
2. When the album function is on, LCD displays the name of album song and the indicate of album. Now use the data dial, [+ / YES] or [- / NO] button can select the song to play. The instrument will adjust the accompaniment parameters to fit that song.
3. Press voice direct button or style direct button can exit the album function.

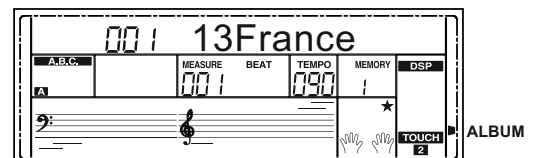
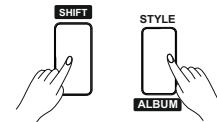

Record

With the easy-to-use song recording features, you can record your own keyboard performances as a user song. 5 user songs can be recorded with 6 tracks (1 ACCOMP track, 5 MELODY tracks) each.

Start Recording

Before you start recording, you need to select a user song to keep the recording song.

1. Holding down [SHIFT] button and then press the [RECORD] button to enter user song selection mode. The LCD displays "RecSong1" and sequence number. 5 user songs can be recorded. Use the data dial, [+ / YES] or [- / NO] button select the user song you want to record.
2. Holding down [SHIFT] button and then press the [RECORD] button again to enter record preparation mode. LCD lightens the "REC" flag, and LCD will flash beat indicate. The instrument will automatically select an empty track to record your performance. The LCD indicates in the left which flashes shows the record track.
3. In the recording preparation status, you can adjust parameters such as the voice, style and tempo. When recording a new song, it will automatically select "Melody 1" as the recorded track. Holding down [SHIFT] button and then press "ACCOMP" (or "MELODY1" to "MELODY 5") to make your own selection. The ACCOMP track and one of MELODY track can be recorded at the same time, but it cannot record two MOLODY track simultaneously.
4. Press [START/STOP] button or play the keyboard to start recording. When choosing the ACCOMP tack and A.B.C. is open, play an effective chord in left hand section or press [START/STOP] button would start recording.

Select a Track

The recording track LCD indicates has three states: Blinking, Light, and Go out.

Blinking: It means the track was chosen for recording. If the track has recorded data, the original data will be replaced.

Light: It means this track have data, the recording process will record data with playback the recorded track at the same time.

Go out: There are two cases, one is that this track has data and cannot playback when recording, the other one is that this track has no data and you can select "ACCOMP" track (or "MELODY 1" or "MELODY 2"), repeatedly press buttons which corresponding to each track, shift track state between blinking, light and go out.

Note:

1. Record style with accompaniment track, and record melody with melody track.
2. In the recording preparation status, you can repeatedly press the [ACCOMP], [MELODY 1] ~ [MELODY 5] button to shift track state. When recording an existing song, the keyboard will automatically select the empty track next to the occupied track. For example, if "Melody 1" is occupied, then "Melody 2" will be selected as the record track. When all 6 tracks have been recorded, select the "melody 1" track to save recordings.

Stop Recording

1. When recording is in process, holding down [SHIFT] button and then press the [RECORD] button to stop recording.

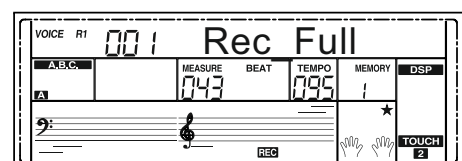
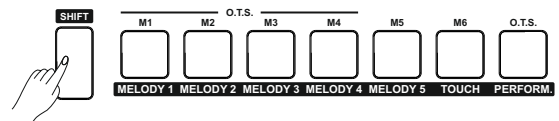
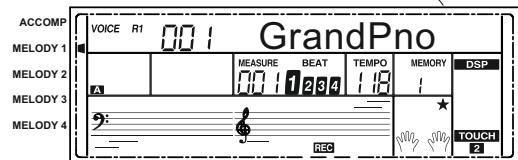
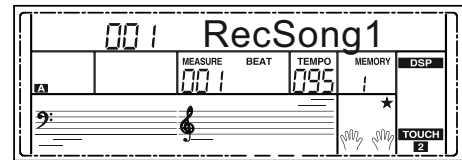

- When recording is in process, if the memory is full, the recording will stop and save automatically, and the LCD displays "Rec_Full".
- If you choose the accomp recording, the recording will stop automatically when the ending of the rhythm finishes.

Playback Recording

- When recording is in process, holding down [SHIFT] button and then press the [RECORD] button, it will stop recording and enter the song play mode, the LCD displays default name "UserSong" and number of user song, the current recorded song will play automatically in circle.
- Press the [SONG] button to enter the song mode and it will play all songs circularly. Use the data dial, [+ /YES] or [- /NO] button to select a song, there are 155 songs in all, including 5 user songs (151~155). If there is no data in the selected user song, it will display "NoFile!" and stop playing.
- You can select one user song in song stop playing mode, press [START/STOP] button, this user song will play circularly.

Note:

- All user songs won't be erased even turn the instrument off.
- In user song selection mode, just easily press the corresponding track button to choke track, the prompt icon goes out at the same time and the tracks you have selected will not be sounded while playing back it.

Delete User Song

- Pressing and holding [RECORD] and [STORE] button together and turn power on simultaneously, all user songs will be erased.
- In the recording preparation status, holding down [SHIFT] button and then press the [RECORD] button for two seconds, the LCD will display "Delete?" Now you can press [ACCOMP] (or [MELODY 1] to [MELODY 5]) button to select the track you want to delete. When some track indicate is lightened, it indicates that the track data you want to delete, otherwise, it indicate that the track data you want to keep. If all the track indicates are lightened, the whole user song will be erased after confirmation.
- Choose the track you want to delete, press [+ /YES] to confirm and the recorded data in this track will be erased. Press [- /NO] to quit this step, and go back to the recording preparation status.

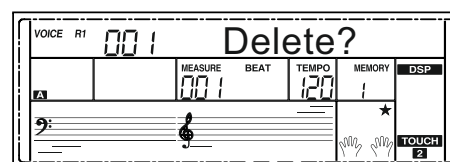
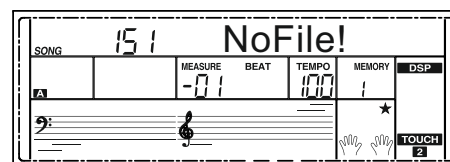

Song

The instrument has 150 songs in all, and each song has equipped with smart learning mode.

Listen to the songs

1. Press the [SONG] button to enter the song mode. The LCD shows "SONG" indicate and it will play all songs circularly.
2. Use the data dial, [+ / YES] or [- / NO] button to select a song.
3. Once you start playing a song by pressing [▶/■] button, it will play current song repeatedly.
4. When the song is stopped, press the [STYLE], [RECORD], [VOICE], [DUAL] OR [LOWER] button and so on will exit the song mode.

Song Control

1. **Introductory Beat**
Before song start playing, it has the introductory beat; the measure starts from negative value. It begins to play song when the measure goes to 1.
2. **REW, FF and PAUSE**
When the song is playing:
Press the [▶▶] button to fast forward the song.
Press the [◀◀] button to rewind the song (base on the measure).
Press the [⏸] button to pause the playing song, press again to continue playing.
3. **Song Repeat**
When playing the song, press the [↺] to set the loop begin and press it again to set the loop end. When in loop status, press [↺] again to quit the loop playing status.

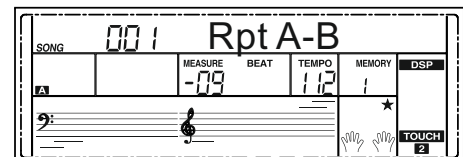
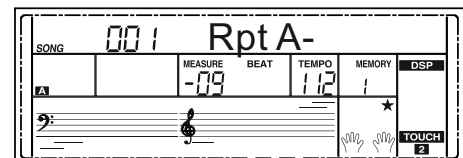
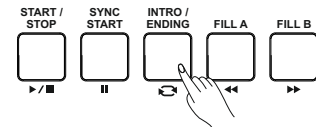
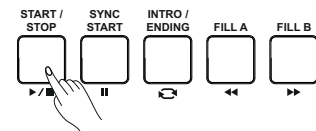
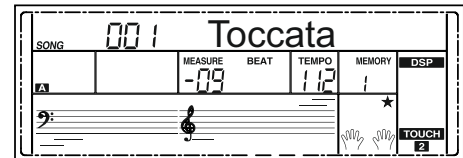

Smart Learning System

This built-in smart learning mode provides many different ways in which to help you learning a new song faster and better. It's function mainly includes: Intelligently and reasonably arrange your learning lessons; Arrange songs specific exercises for your study; Record your learning progress; the more your learning level have progressed, the more starts you will get.

Smart Learning

How to start the smart learning mode?

Press the [SMART LEARNING] button, the information of name and number of song you want to learn will scrolling on the LCD screen, and then Temporarily display the lesson you are going to learn, then enter the song learning mode.

Note:

- As scrolling the name of song, the LCD displays difficult level of song learning in the Grade Level area, as the picture of LCD on the right, the current grade level is a sun, one sun equals to three starts, and that is to say it is a very hard difficulty level. You can refer to level details on the right.
- Use the data dial, [+ / YES] or [- / NO] button conveniently select a song from easy to difficult levels.
- In the process of learning, the LCD displays the highest score of previous challenge learning. The default score is 0.

What is period and phrase?

The fastest way to learning a new song is divide the song into several parts, and individually practice each part. While you have a good command of each part, it may become very easy to learning a complete song.

A musical phrase is a unit of musical meter that has a complete musical sense of its own. Just like a complete sentence in an article. In music, a period is a group of phrases consisting usually of at least one phrase, a common combination is two or four phrases, but three, five or more phrases still exist.

Refer to the relationship of song, period and phrase on the right picture.

How to practicing with smart learning?

In order to help you learning songs faster and easier, 8 lessons have pre-programmed in this instrument, step learning of pitch, timing, left hand, right hand, period, phrase and so on, try to learning a new song in an enjoyable way. The contents of each lesson are referring to the following list:

NO.	LCD	Content of Lesson
1	LESSON 1	Learn right hand pitch of period/phrase.
2	LESSON 2	Learn right hand pitch and timing of period/phrase.
3	LESSON 3	Learn left hand pitch of period/phrase.
4	LESSON 4	Learn left hand pitch and timing of period/phrase.
5	LESSON 5	Learn both hands pitch of period/phrase.
6	LESSON 6	Learn both hands pitch and timing of period/phrase.
7	LESSON 7	Learn both hands pitch and timing of complete song.
8	LESSON 8	High score challenge.

The system auto start lesson 7 (complete song learning) after you have finished lessons from 1 to 6.

During the learning of lesson 7, the system will automatically call up the period which you have played with most mistakes, individually practice this period, until you can expertly play this song.

After finished above lessons, the system will automatically turn into the lesson 8 (High score challenge), you can challenge the highest score, and the score will be permanently recorded.

As picture shows on the right, you can find the typical process of intelligent learning.

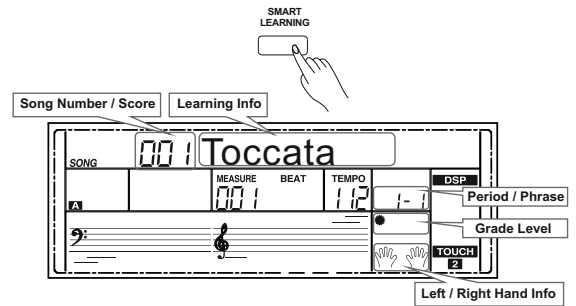

LCD Display	Grade Level
☀️ ☾ ☽ ☆ ★	Very Easy
☀️ ☾ ☽ ★ ★	Easy
☀️ ☾ ☽ ☆ ☆	Medium
☀️ ☾ ☽ ☆ ☆	Hard
☀️ ☾ ☽ ☆ ☆	Very Hard

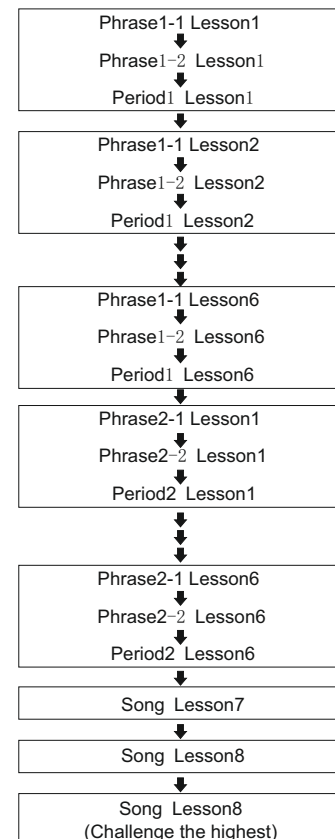
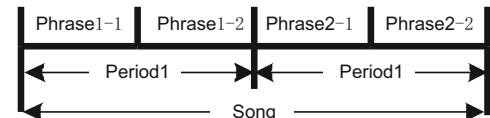

Smart Learning System

Prompt Message

LCD	Description
Lesson 1	Prepare for the next lesson.
Play A	preview the phrase which you ready to learn
Try A	Prompt the phrase which you are learning.
Go Ahead	You have passed the current period/ phrase, please prepare for the next period / phrase.
Try Again	You haven't passed the current period/ phrase, please try again.
Play A-H	preview the period you ready to learning
Try A-H	Prompt the period you are learning.
Complete !	You are going to lesson 7 (Complete song learning).
Challenge!	You are going to lesson 8 (High score learning).
Score: 85	Your learning score.
Retry ?	Prompt if you want to play again when you finish this challenge learning.

Lesson 1/3/5 (Pitch)

With lesson 1/3/5, you can learn how to currently play melody pitch and accompaniment chords of songs. These three lessons are played in a same method. We are going to introduce the lesson 1 as an example.

1. Press [SMART LEARNING] button, start the smart learning. Use data dial or [+ / YES] / [- / NO] button to select a song you want to learn.
2. The LCD currently displays name and number of song and, a litter while, display the name of lesson "Lesson 1". Now, it begins to play phrase, the LCD display "Play A", at the same time, listening carefully and watching each note of staff.
3. While introduce phrase stop playing, lesson 1 will be started. The LCD displays "Try A", and you can play the right key according to the staff.
Note:
Unless you press the right note on the keyboard, the song will continue playing normally. If you don't play the keys, the lesson mode will keeps waiting until you play a correct note.
4. After you have finished this phrase the LCD will display your current learning score "SCORE: XX". If you have got a score of 80 or more points, congratulations, you have passed this lesson, and you can enter the next phrase learning. The LCD displays "Go Ahead". If you have got a score less than 80 points, the LCD displays "Try Again", it means you have to repeat this phrase again.

Note:

If you still cannot get 80 points after repeat this phrase 3 times, the system will replay the current phrase again to help you be familiar with it. Repeatedly practice, until you play these phrases.

Lesson 2/4/6 (Pitch and Timing)

With lesson 1/3/5, you can learn how to currently play melody pitch and accompaniment chords of songs, and then practice with lesson 2/4/6 you can further control the timing better. That is to say, play songs with correct timing, pitch or chord.

These three lessons are played in a same method. We are going to introduce lesson 2 as an example.

1. The system automatically enters the lesson 2 after you have passed the lesson 1; The LCD displays "Lesson 2".
2. In lesson 2 mode, the system will preview the period /phrase you want to play, and then restart the lesson 2 learning. The LCD displays "Try A".

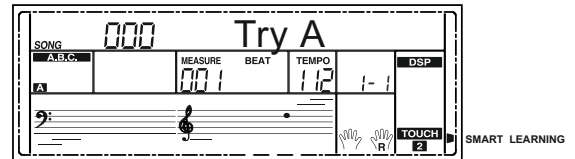
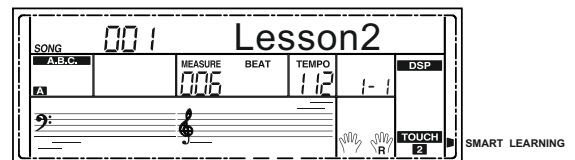
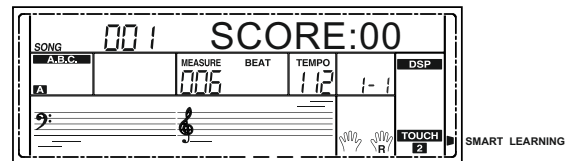
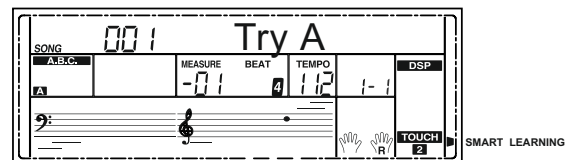
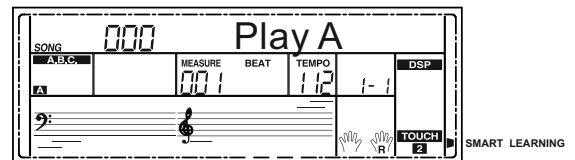
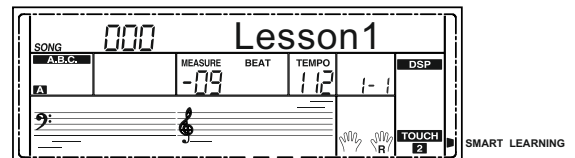
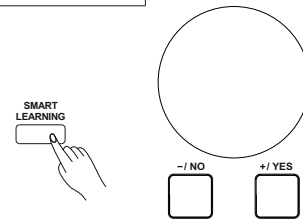

- The LCD currently displays your learning score: "SCORE: XX". If your score is or more than 80 points, you can prepare for the next lesson, the LCD will display "Go Ahead", or the LCD will display "Try Again", repeat practicing current phrase.
- The tempo will decrease about 10%, if the period/phrase still cannot pass after 3 times practicing (For example, the original tempo is 100, and will down to 90); you can practice with the new tempo.
If your score reach 80 points, the tempo will automatically recover 10%, repeatedly practice period/phrase until you can play songs smoothly at the original tempo.

Note:

The tempo value will decrease about 50% at most. In addition, you can press [TEMPO +] and [TEMPO -] buttons simultaneously to reset its original default value.

Lesson 7 (Complete Song Learning)

- Normally, you can start lesson 7 after finished lesson 1~6. Of course, you can directly enter lesson 7 by pressing [▶▶] button. The LCD displays "Complete!" means you are preparing to learn lesson 7.
- In lesson 7 mode, the instrument will completely play back a song for once, and then start pitch and timing practicing. After that, the system will pick up phrases which played with most mistakes. Focus on these phrases learning.
After phrases learning, the system restarts complete song learning. Repeatedly practice until you can play the song smoothly.

Lesson 8 (High Score Challenge)

Finish above lessons, you can automatically enter the lesson 8 learning, the high score learning. The LCD displays "Challenge!" and your score of last challenge.
Surely, if you want to directly challenge a song, you can press [▶▶] button, and switch to lesson 8 quickly. After you finish this lesson, the LCD will display your score and corresponding prompt sound. As the list below:

Score	Prompt Sound
<60	Try Again
60~69	Ok
70~79	Good
80~89	Very Good
90~100	Excellent

If the final score is more than the highest score of this song records, then congratulations! This indicates that you have challenged successfully and your study score will be permanently recorded.

Select a Lesson

Except follow the principle learning procedure, you can also press the [◀◀] or [▶▶] button to freely select a lesson.

You can select a lesson from lesson 1 to lesson 8; the LCD will display relevant information of lesson.

Pause the Lesson

Press the [⏸] button during lesson learning. Press the [⏸] button again and the lesson will resume from the current position.

Note:

The [⏸] button cannot be used to pause lesson learning in lesson 1/3/5.

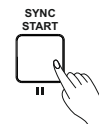
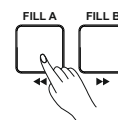
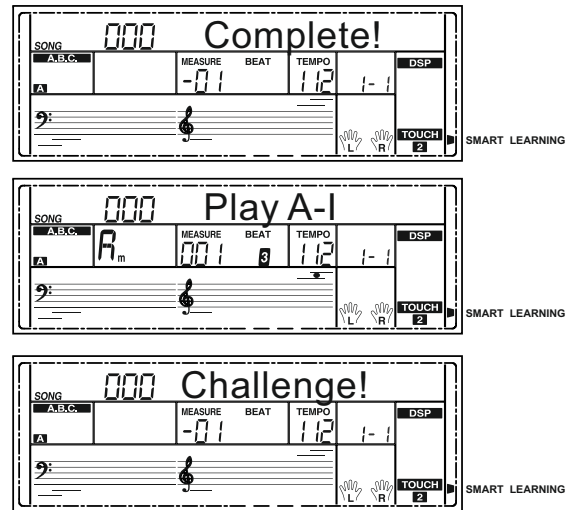

Stop/Start the Lesson

In the process of learning you can press the [start/stop] button to stop or start to learn, if in the process of learning to press the [start/stop] button will stop and return to you for what you have learn the current courses.



The Records of Lesson Learning Process

Your lesson learning process will be recorded even turn the power off; in other words, the system will automatically skip into the last position you exit, when you enter the smart learning next time.

Note:

The recorded learning position will be lost if you turn the power to the instrument off without executing the save operation. For example, un-normal power off and suddenly electronic cut off.

Metronome Introductory Learning

The introductory metronome provides a click sound, giving you an accurate tempo guide when you practice, or letting you easily start the lesson learning.

Note:

Cause only two tracks in a piano song, in lesson 6/7/8, there is no any accompaniment music, so, in the mean time, the system will automatically start metronome to help your lesson learning.

Gold Star

This instrument has equipped the gold star list, which can be used to mark your learning steps from a rookie level to a master level. It just likes your loyal music partner; record every progress you have made. As the time you have practiced and high score challenge you have passed, you can get more gold stars.

The LCD will display the star level when you power on, it indicates your instrument level. There are 17 levels in all, please refer to the list below:

Rank	Display	Rank	Display
1	☀️ ☾☾ ☆★	10	☀️ ☾☾ ☆★
2	☀️ ☾☾ ★★	11	☀️ ☾☾ ★★
3	☀️ ☾☾ ☆☆	12	☀️ ☾☾ ☆☆
4	☀️ ☾☾ ☆★	13	☀️ ☾☾ ☆★
5	☀️ ☾☾ ★★	14	☀️ ☾☾ ★★
6	☀️ ☾☾ ☆☆	15	☀️ ☾☾ ☆☆
7	☀️ ☾☾ ☆★	16	☀️ ☾☾ ☆★
8	☀️ ☾☾ ★★	17	☀️ ☾☾ ★★
9	☀️ ☾☾ ★★		☀️ ☾☾ ★★
	☀️ ☾☾ ☆☆		

Note:

1. The ☾ equals three ★, and the ☀️ equals nine ★.
2. The level of gold star list depends on the score of song learning and the time you have practiced.

If you know the name of a chord but don't know how to play it, you can use the Chord Dictionary function. You can learn the chord and test in this features.

DICT 1 (Chord Learning Mode)

Press and hold the [SHIFT] button, and then press the [DICT.] button to enter the DICT 1 mode, the LCD displays "Dict.1" and the A.B.C. automatically turned on. In DICT 1 mode, the keys C4~B5 are used to assign the Chord Type, the keys C6~B6 are used to assign the Chord Root. When the Chord Type and Chord Root are confirmed, the LCD will display the Chord and its keyboard position. For example, if you want to play a CM7 Chord, press the C6 key to specify C as the chord root. The root note you set will be shown on the LCD but the note doesn't sound. Refer to the picture on the right for assigning the Chord Root.

Press the E4 key to specify M7 as chord type. The notes you should play for the specified chord (root and chord type) are shown in the LCD as the notation and also in the keyboard diagram. When the Chord Type and Chord Root are confirmed, the LCD will display the chord and its keyboard position. A prompt sound will be heard when you play it correctly.

DICT 2 (Chord Examining Mode)

Press and hold the [SHIFT] button, and then press the [DICT.] button to enter the DICT 2 mode. This is an Examining mode. The chord area on the LCD will display a random chord while the keyboard position doesn't display anything on LCD. When you play the correct chord within 3 seconds, the next chord (random) will be displayed on LCD to wait for the correct chord playing. If not, LCD will display the corresponding keyboard position automatically. In DICT 2 mode, press and hold the [SHIFT] button, and then press the [DICT.] button again to turn off chord dictionary.

24 Chords will be displayed in the dictionary mode as follows:

Note	Chord Root	Note	Chord Root	Note	Chord Root
C6	C	C4	M	C5	7(b9)
C#6	C#/Db	C#4	M(9)	C#5	7(9)
D6	D	D4	6	D5	7(#9)
Eb6	Eb/D#	Eb4	mM7	Eb5	7(b13)
E6	E	E4	M7	E5	7(13)
F6	F	F4	M	F5	7(#11)
F#6	F#/Gb	F#4	M(9)	F#5	dim7
G6	G	G4	M6	G5	dim
Ab6	Ab/G#	Ab4	M7(9)	Ab5	7aug
A6	A	A4	M7	A5	aug
Bb6	Bb/A#	Bb4	M7b5	Bb5	7sus4
B6	B	B4	7	B5	sus4

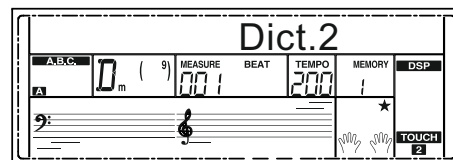
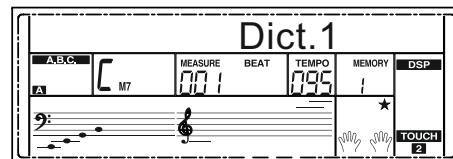
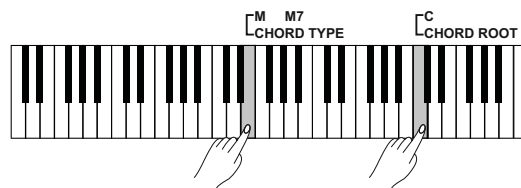
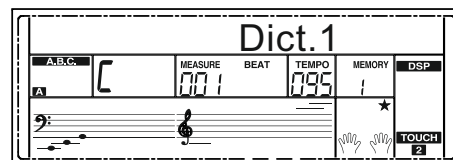
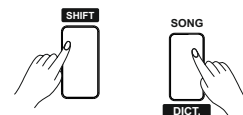

MIDI

With the MIDI functions you can expand your musical possibilities. This section will let you know what MIDI is, and what it can do, as well as how you can use MIDI on your instrument.

What's MIDI?

1. MIDI (short for Musical Instrument Digital Interface) allows a wide variety of electronic musical instruments, computers and other related devices to connect and communicate with one another. MIDI carries event messages that specify notation, pitch and velocity, control signals for parameters such as volume, vibrato, audio panning, and program change information to change the voice selections.
2. The instrument can output the real-time playback information via MIDI and control external MIDI devices. The instrument can also accept incoming MIDI messages and generate sound accordingly.

Note:

This instrument has a USB(DEVICE) terminal, which can be connected to a PC as an MIDI input or MIDI output. This can not be connected with another instrument, unless other USB host device with an USB terminal.

Upload/Download Data from the Computer

1. Connect a standard USB cable between the rear-panel USB jack on the instrument and the USB jack on your computer.
2. Power on the instrument first, and then open the PCSUITE software in your computer. If the LCD displays "PCLink.." it indicates the piano connects the PC successfully.
3. You can download 5 MIDI files to the keyboard as user songs or upload the user songs to PC.
4. You can upload user styles to the computer as a backup or download them to the keyboard. You can upload memory files to the computer as a backup or download them to the keyboard.
5. Please refer to software operation instructions for detail operating methods.

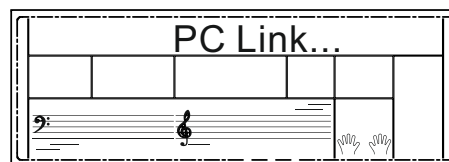
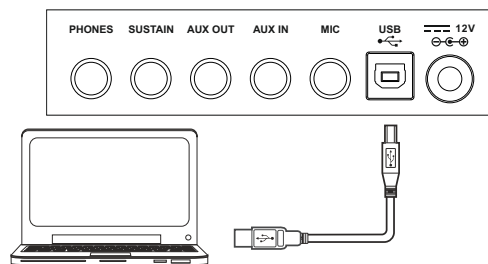

Problem	Possible Cause and Solution
The speakers produce a pop sound whenever the power is turned ON or OFF.	This is normal and is no cause for alarm.
No sound when the keyboard is played.	The R1/R2/L voice volume (Mixer) settings could be set too low. Make sure the voice volumes are set at appropriate levels.
When using a mobile phone, noise is produced.	Using a mobile phone in close proximity to the instrument may produce interference. To prevent this, turn off the mobile phone or use it further away from the instrument.
The auto accompaniment does not play back even Sync is in standby condition and a key is pressed.	You may be trying to start accompaniment by playing a key in the right-hand range of the keyboard. To start the accompaniment with Sync Start, make sure to play a key in the left-hand range of the keyboard.
Certain notes sound at wrong pitch.	Make sure that the tuning value is set to 0. Press and hold the [+ / YES] and [- / NO] buttons at the same time, then turning the power on will set INSTRUMENT to default.
The Harmony function does not operate.	And Harmony cannot be turned on when a drum kit is selected for the voice R1.

Notice:

If you notice any abnormality cannot handle, please connect the provider or specified repair station, and have the instrument inspected by qualified service personnel.

Specifications

LCD Display

Multi-functional LCD

Keys

61 Keys with Touch Response

Polyphony

128

Voices

618

Songs

150 Preset Songs and 5 User Songs

Styles

200 Preset Songs and 10 User Styles

Demos

5

Album

310

Tempo

30 – 280

Panel Memory

48

DSP

With DSP function, you can make your performance to be broader and fuller expression.

Chord Mode

Both single-finger mode and multi-finger mode.

Chord Dictionary

It is convenient for chord learning.

Accompaniment/Song Control

Start/Stop, Sync Start (Pause), Intro/Ending (Repeat A/B), Fill A (REW), Fill B (FF), Chord Mode, Fade.

Record

Record, Start/ Stop, Accomp Track, Melody Track 1~5

Control button

Power Switch, Volume Slider, Modulation Button, Pitch Bend, Style Direct Button 1~10, Shift, Tempo +/- (ACCMP +/-), Metronome (Octave), Mixer (Transpose), Harmony (Sustain), Start/ Stop, Sync Start (Pause), Intro/ Ending (Repeat), Fill A (REW), Fill B (FF), Chord (Fade), Bank (Record), Store (ACCOMP), Dual, Lower, Function, Smart Learning, M1~5(Melody1~5), M6 (Touch), O.T.S. (Perform.), Voice Direct Button 1~10, Voice, Style (Album), Song (Dict.), Piano (DSP), Demo, -/NO, +/Yes, Data Dial.

Connectors

PHONES, SUSTAIN, AUX OUT, AUX IN, MIC, USB, DC IN.

Power Supply

DC IN 12V/2000mA

Speaker

4 ohm 15Wx2

8 ohm 20Wx2

Dimensions

970(L) x370(W) x142(H) mm

Weight

6.75 KG

* All specifications and appearances are subject to change without notice.

Voice List

No.	English Name	LCD Display
Piano		
1	Acoustic Grand Piano	GrandPno
2	Acoustic Grand Piano 2	GrandPn2
3	Acoustic Grand Piano (wide)	GrandPnW
4	Acoustic Grand Piano (dark)	GrandPnD
5	Bright Acoustic Piano	BritePno
6	Bright Acoustic Piano 2	BritePn2
7	Bright Acoustic Piano (wide)	BritePnW
8	Electric Grand Piano	E.Grand
9	Electric Grand Piano 2	E.Grand2
10	Electric Grand Piano (wide)	E.GrandW
11	Electric Grand Piano (dark)	E.GrandD
12	Honky Tonk Piano	HnkyTonk
13	Honky Tonk Piano 2	HnyTonk2
14	Honky Tonk Piano (wide)	HnyTonkW
15	Honky Tonk Piano (dark)	HnyTonkD
16	Harpsichord	Harpsi
17	Harpsichord 2	Harpsi2
18	Harpsichord (octave mix)	HarpsiO
19	Harpsichord (wide)	HarpsiW
20	Harpsichord (with key off)	HarpsiOf
21	Octave Grand Piano	OctPno
22	Octave Grand Piano 2	OctPno2
23	Piano & Strings	Pno&Str
24	Piano & Pad	Pno&Pad
25	Piano & Choir	Pno&Cho
26	Piano & EP	Pno&EP
27	Piano & Vibraphone	Pno&Vib
28	Detuned Electric Piano	DetunEP
29	Detuned Electric Piano 2	DetunEP2
30	Electric Piano	E.Piano
31	Electric Piano 2	E.Piano2
32	Electric Piano 3	E.Piano3
33	Electric Piano 4	E.Piano4
34	Electric Piano 1 (velocity mix)	E.PnoV1
35	Electric Piano 2 (velocity mix)	E.PnoV2
36	60's Electric Piano	60'sEP
37	EP Legend	EPLegend
38	Phase EP	PhaseEP
39	Clavi	Clavi
40	Clavi 2	Clavi2
41	Phase Clavi	PhaseClv
42	Wah Clavi	WahClv
43	Pulse Clavi	PluseClv
44	Dream EP	DreamEP
45	Tremolo EP	TremoEP
46	Funk EP	FunkEP
47	Warm EP	WarmEP
48	Choir EP	ChoriEP
49	Wah EP	WahEP
50	Modern EP	ModernEP
51	EP Pad	EPPad
Chromatic Percussion		
52	Celesta	Celesta
53	Celesta 2	Celesta2

54	Celesta 3	Celesta3
55	Glockenspiel	Glocken
56	Glockenspiel 2	Glocken2
57	Music Box	MusicBox
58	Music Box 2	MuscBox2
59	Music Box 3	MuscBox3
60	Vibraphone	Vibra
61	Vibraphone 2	Vibra2
62	Vibraphone (wide)	VibraW
63	Marimba	Marimba
64	Marimba 2	Marimba2
65	Marimba (wide)	MarimbaW
66	Xylophone	Xylophon
67	Xylophone 2	Xylopho2
68	Xylophone 3	Xylopho3
69	Tubular Bells	TubulBel
70	Tubular Bells 2	TubulBe2
71	Church Bell	ChurBell
72	Carillon	Carillon
73	Dulcimer	Dulcimer
74	Dulcimer 2	Dulcime2
75	Santur	Santur
Organ		
76	Italian 60's Organ	60'sOrgn
77	Drawbar Organ	DrawOrgn
78	Drawbar Organ 2	DrawOrg2
79	Detuned Drawbar Organ	DeDraOrg
80	Drawbar Organ 3	DrawOrg3
81	Detuned Percussive Organ	DePerOrg
82	Percussive Organ	PercOrgn
83	Percussive Organ 2	PercOrg2
84	70's Percussive Organ	70'sPcOr
85	Percussive Organ 3	PercOrg3
86	Rock Organ	RockOrgn
87	Rock Organ 2	RockOrg2
88	Rock Organ 3	RockOrg3
89	Church Organ	ChurOrgn
90	Church Organ 2	ChurOrg2
91	Church Organ 3	ChurOrg3
92	Church Organ (octave mix)	ChurOrgO
93	Detuned Church Organ	DeChuOrg
94	Reed Organ	ReedOrgn
95	Reed Organ 2	ReedOrg2
96	Rotary Organ	RotyOrgn
97	Puff Organ	PuffOrgn
98	Accordion	Acordion
99	Accordion 2	Acordin2
100	Accordion 3	Acordin3
101	Harmonica	Harmnica
102	Harmonica 2	Harmnic2
103	Harmonica 3	Harmnic3
104	Tango Accordion	TangoAcCd
105	Tango Accordion 2	TangAcCd2
Guitar		
106	Acoustic Guitar (nylon)	NylonGtr
107	Acoustic Guitar (nylon) 2	NylonGt2

Voice List

108	Acoustic Guitar (nylon) 3	NylonGt3
109	Acoustic Guitar (nylon + key off)	NylGtrOf
110	Ukulele	Ukulele
111	Acoustic Guitar (steel)	SteelGtr
112	Acoustic Guitar (steel) 2	SteelGt2
113	12-Strings Guitar	12StrGtr
114	Mandolin	Mandolin
115	Mandolin 2	Mandoli2
116	Steel Guitar with Body Sound	SteelBdy
117	Electric Guitar (jazz)	JazzGtr
118	Electric Guitar (jazz) 2	JazzGtr2
119	Electric Guitar (pedal steel)	PedalGtr
120	Electric Guitar (clean)	CleanGtr
121	Electric Guitar (clean) 2	CleanGt2
122	Electric Guitar (detuned clean)	DetClnGt
123	Mid Tone Guitar	MidTonGt
124	Electric Guitar (muted)	MutedGtr
125	Electric Guitar (muted) 2	MutedGt2
126	Electric Guitar (funky cutting)	FunkGt
127	Electric Guitar (muted velo-sw)	MutVelGt
128	Jazz Man	JazzMan
129	Overdriven Guitar	Ovrdrive
130	Overdriven Guitar 2	Ovrdriv2
131	Guitar Pinch	GtPinch
132	Distortion Guitar	DistGtr
133	Distortion Guitar 2	DistGtr2
134	Distortion Guitar (with feedback)	FeedbkGt
135	Guitar Feedback	GtrFdbk
136	Distorted Rhythm Guitar	DistRyth
137	Guitar Harmonics	GtrHarmo
138	Guitar Harmonics 2	GtHarmo2
139	Velocity Nylon Guitar	NyInGtVe
Bass		
140	Acoustic Bass	AcoBass
141	Acoustic Bass 2	AcoBass2
142	Wah Bass	WahBass
143	Electric Bass (finger)	FngrBass
144	Finger Slap Bass	FngrSlap
145	Electric Bass (pick)	PickBass
146	Electric Bass (pick) 2	PickBas2
147	Fretless Bass	Fretless
148	Fretless Bass 2	Fretles2
149	Slap Bass	SlapBass
150	Slap Bass 2	SlapBas2
151	Slap Bass 3	SlapBas3
152	Slap Bass 4	SlapBas4
153	Synth Bass	SynBass
154	Synth Bass 2	SynBass2
155	Synth Bass 3	SynBass3
156	Synth Bass 4	SynBass4
157	Warm Synth Bass	WarmBass
158	Rsonance SynBass	ResoBass
159	Clavi Bass	ClavBass
160	Hammer	Hammer
161	Attack Bass	AtackBas
162	Synth Bass (rubber)	RubbBass

163	Synth Bass (rubber) 2	RubbBas2
164	Attack Pulse	AtackPls
Strings & Orchestral		
165	Violin	Violin
166	Violin 2	Violin2
167	Violin (slow attack)	SIViolin
168	Viola	Viola
169	Viola 2	Viola2
170	Cello	Cello
171	Cello 2	Cello2
172	Contrabass	Contrabs
173	Contrabass 2	Contrbs2
174	Tremolo Strings	TremStr
175	Tremolo Strings 2	TremStr2
176	Tremolo Strings 3	TremStr3
177	Pizzicato Strings	PizzStr
178	Pizzicato Strings 2	PizzStr2
179	Orchestral Harp	Harp
180	Orchestral Harp 2	Harp2
181	Yang Chin	YangChin
182	Timpani	Timpani
183	Timpani 2	Timpani2
184	String Ensembles	Strings
185	String Ensembles 2	Strings2
186	String Ensembles 3	Strings3
187	String Ensembles 4	Strings4
188	Strings & Brass	Str&Bras
189	60's Strings	60'sStr
190	Synth Strings	SynStrs
191	Synth Strings 2	SynStrs2
192	Synth Strings 3	SynStrs3
193	Synth Strings 4	SynStrs4
194	Synth Strings 5	SynStrs5
195	Choir Aahs	ChoirAah
196	Choir Aahs 2	ChorAah2
197	Choir Aahs 3	ChorAah3
198	Voice Oohs	VoiceOoh
199	Voice Oohs 2	VoicOoh2
200	Humming	Humming
201	Anlong Voice	AnlVoice
202	Synth Voice	SynVoice
203	Synth Voice 2	SynVoic2
204	Orchestra Hit	OrchHit
205	Orchestra Hit 2	OrchHit2
206	Bass Hit Plus	BassHit
207	6th Hit	6thHit
208	Euro Hit	EuroHit
Brass		
209	Trumpet	Trumpet
210	Trumpet 2	Trumpet2
211	Dark Trumpet	DarkTrp
212	Trombone	Trombone
213	Trombone 2	Trmbone2
214	Trombone 3	Trmbone3
215	Bright Trombone	BritBone
216	Tuba	Tuba

217	Tuba 2	Tuba2
218	Muted Trumpet	MuteTrp
219	Muted Trumpet 2	MuteTrp2
220	Muted Trumpet 3	MuteTrp3
221	French Horn	FrHorn
222	French Horn 2	FrHorn2
223	French Horn 3	FrHorn3
224	Brass Section	Brass
225	Brass Section 2	Brass2
226	Brass Section 3	Brass3
227	Synth Brass	SynBrass
228	Synth Brass 2	SynBras2
229	Synth Brass 3	SynBras3
230	Synth Brass 4	SynBras4
231	Synth Brass 5	SynBras5
232	Synth Brass 6	SynBras6
233	Synth Brass 7	SynBras7
234	Synth Brass 8	SynBras8
235	Analog Synth Brass	AnaBrass
236	Analog Synth Brass 2	AnaBras2
237	Analog Synth Brass 3	AnaBras3
238	Jump Brass	JumpBras
239	Jump Brass 2	JumpBrs2
240	Funny	Funny
241	Funny 2	Funny2
Reed		
242	Soprano Sax	SprnoSax
243	Soprano Sax 2	SprnSax2
244	Soprano Sax 3	SprnSax3
245	Alto Sax	AltoSax
246	Alto Sax 2	AltoSax2
247	Alto Sax 3	AltoSax3
248	Tenor Sax	TenorSax
249	Tenor Sax 2	TenoSax2
250	Tenor Sax 3	TenoSax3
251	Baritone Sax	BariSax
252	Baritone Sax 2	BariSax2
253	Baritone Sax 3	BariSax3
254	Oboe	Oboe
255	Oboe 2	Oboe2
256	Oboe 3	Oboe3
257	2 Oboes	2Oboes
258	English Horn	EngHorn
259	English Horn 2	EngHorn2
260	English Horn 3	EngHorn3
261	2 English Horns	2EngHons
262	Bassoon	Bassoon
263	Bassoon 2	Bassoon2
264	Bassoon 3	Bassoon3
265	2 Bassoons	2Bassoons
266	Clarinet	Clarinet
267	Clarinet 2	Clarinet2
268	Clarinet 3	Clarinet3
269	2 Clarinets	2Clarinets
Pipe		
270	Piccolo	Piccolo

271	Piccolo 2	Piccolo2
272	Piccolo 3	Piccolo3
273	2 Piccolos	2Piccolos
274	Sweet Flute	SweeFlut
275	Flute	Flute
276	Flute 2	Flute2
277	Flute 3	Flute3
278	2 Flutes	2Flutes
279	Recorder	Recorder
280	Recorder 2	Recorde2
281	2 Recorders	2Records
282	Pan Flute	PanFlute
283	Pan Flute 2	PanFlut2
284	Sweet Pan Flute	SwPanFlu
285	Blown Bottle	Bottle
286	Blown Bottle 2	Bottle2
287	Shakuhachi	Shakhchi
288	Shakuhachi 2	Shakhch2
289	Whistle	Whistle
290	Whistle 2	Whistle2
291	Ocarina	Ocarina
292	Ocarina 2	Ocarina2
Synth Lead		
293	Lead 1 (square)	SquareLd
294	Lead 1a (square) 2	SquarLd2
295	Lead 1 (square) 3	SquarLd3
296	Lead 1b (sine)	SineLead
297	Lead 2 (sawtooth)	SawLead
298	Lead 2a (sawtooth) 2	SawLead2
299	Lead 2 (sawtooth) 3	SawLead3
300	Lead 2b (saw + pulse)	SawPlsLd
301	Lead 2c (double sawtooth)	DubSawLd
302	Lead 2d (sequenced analog)	SquAnaLd
303	Lead 2d (sequenced analog) 2	SqAnaLd2
304	Wavy Sawtooth	WavySaw
305	Bauble Lead	BaubleLd
306	Super Analog	SuperAna
307	Lead 3 (calliope)	CalliopLd
308	Lead 3 (calliope) 2	CalipLd2
309	Lead 4 (chiff)	ChiffLd
310	Lead 4 (chiff) 2	ChiffLd2
311	Lead 4 (chiff) 3	ChiffLd3
312	Lead 5 (charang)	CharanLd
313	Lead 5 (charang) 2	CharaLd2
314	Lead 5 (charang) 3	CharaLd3
315	Lead 5 (charang) 4	CharaLd4
316	Lead 5a (wire lead)	WireLead
317	Lead 5a (wire lead) 2	WireLd2
318	Lead 6 (voice)	VoiceLd
319	Lead 6 (voice) 2	VoiceLd2
320	Lead 7 (fifths)	FifthsLd
321	Lead 7 (fifths) 2	FifthLd2
322	Lead 8 (bass + lead)	BassLead
323	Lead 8 (bass + lead) 2	BasLead2
324	Lead 8 (bass + lead) 3	BasLead3
325	Lead 8a (soft wrl)	SftWrLd

Voice List

326	Massiness	Massin
327	Square	Square
328	Slow Square Lead	SlwSquLd
329	Sine Solo	SineSolo
330	Square Lead 4	SquarLd4
331	Thick Square	ThickSqu
332	2Oscillators Lead	2OscLd
333	Wavy Sawtooth 2	WavySaw2
334	Analog Lead	AnaLead
335	Big Lead	BigLead
336	Fat Lead	FatLead
337	PWM 4th	Rezz4th
338	Delayed Lead	DelyLead
339	Delayed Lead 2	DlyLead2
340	Fifth Lead	FifLead
341	Corrie	Corrie
342	Quint	Quint
Synth Pad		
343	Pad 1 (new age)	NewAge
344	Pad 1 (new age) 2	NewAge2
345	Pad 2 (warm)	WarmPad
346	Pad 2 (warm) 2	WarmPad2
347	Pad 2a (sine pad)	SinePad
348	Pad 3 (polysynth)	PolySyn
349	Pad 3 (polysynth) 2	PolySyn2
350	Pad 3 (polysynth) 3	PolySyn3
351	Pad 3 (polysynth) 4	PolySyn4
352	Pad 4 (choir)	ChoirPad
353	Pad 4 (choir) 2	ChoirPd2
354	Pad 4a (itopia)	ItopiaPd
355	Pad 5 (bowed)	BowedPad
356	Pad 5 (bowed) 2	BowedPd2
357	Pad 6 (metallic)	MetalPad
358	Pad 6 (metallic) 2	MetalPd2
359	Pad 7 (halo)	HaloPad
360	Pad 7 (halo) 2	HaloPad2
361	Pad 8 (sweep)	SweepPad
362	Pad 8 (sweep) 2	SweepPd2
363	Pad 8 (sweep) 3	SweepPd3
364	Pan Pad	PanPad
365	Pan Pad 2	PanPad2
366	Dipolar Pad	DipolPad
367	PWM Pad	PWMPad
368	Warmly Pad	WarmlyPd
369	Horn Pad	HornPad
370	Click Pad	ClickPad
371	Analog Pad	AnalogPd
372	80's Poly Pad	80'sPoly
373	PWM 4th Soft	PWM4thSf
374	Synth Calliope Soft	SynCalSf
375	Soft Vox	SoftVox
376	5th SawWave	5thSaw
377	5th Lead Soft	5thLdSf
378	Slow Square	SISquare
379	New Year Pad	NewYear
380	Space Voice	SpcVoice

381	Rising	Rising
382	Congregate	Congrega
Synth SFX		
383	FX 1 (rain)	FXRain
384	FX 1 (rain) 2	FXRain2
385	FX 2 (soundtrack)	Soundtrk
386	FX 2 (soundtrack) 2	Sondtrk2
387	Prelude	Prelude
388	FX 3 (crystal)	Crystal
389	FX 3 (crystal) 2	Crystal2
390	FX 3a (synth mallet)	SynMalet
391	FX 4 (atmosphere)	Atmosphr
392	FX 4 (atmosphere) 2	Atmosph2
393	Warm Air	WarmAir
394	FX 5 (brightness)	Bright
395	Smog	Smog
396	FX 6 (goblins)	Goblins
397	FX 6 (goblins) 2	Goblins2
398	Choir Bell	ChorBell
399	Choir Bell 2	ChorBel2
400	FX 7 (echoes)	Echoes
401	FX 7 (echoes) 2	Echoes2
402	FX 7b (echo pan)	EchoPan
403	FX 7a (echo bell)	EchoBell
404	FX 7a (echo bell) 2	EchoBel2
405	FX 7a (echo bell) 3	EchoBel3
406	FX 8 (sci-fi)	Sci-Fi
407	FX 8 (sci-fi) 2	Sci-Fi2
Ethnic Misc.		
408	Sitar	Sitar
409	Sitar 2	Sitar2
410	Banjo	Banjo
411	Banjo 2	Banjo2
412	Shamisen	Shamisen
413	Shamisen 2	Shamise2
414	Koto	Koto
415	Koto 2	Koto2
416	Taisho Koto	TaishoKt
417	Kalimba	Kalimba
418	Kalimba 2	Kalimba2
419	Bag Pipe	BagPipe
420	Bag Pipe 2	BagPipe2
421	Fiddle	Fiddle
422	Fiddle 2	Fiddle2
423	Fiddle 3	Fiddle3
424	Shanai	Shanai
425	Shanai 2	Shanai2
Percussive		
426	Tinkle Bell	TnkIBell
427	Agogo	Agogo
428	Agogo 2	Agogo2
429	Agogo 3	Agogo3
430	Steel Drums	SteelDrm
431	Steel Drums 2	StelDrm2
432	Woodblock	WoodBlok
433	Woodblock 2	WodBlok2

434	Castanets	Castanet
435	Castanets 2	Castant2
436	Taiko Drum	TaikoDrm
437	Taiko Drum 2	TaikDrm2
438	Taiko Drum 3	TaikDrm3
439	Concert Bass Drum	ConBasDm
440	Concert Bass Drum 2	ConBsDm2
441	Acoustic Bass Drum	BassDrum
442	Room Kick	RoomKick
443	Power Kick	PowrKick
444	Electric Bass Drum	EIBsDrum
445	Analog Bass Drum	AnBsDrum
446	Jazz Kick	JazzKick
447	Side Stick	SidStick
448	Analog Rim Shot	AnRiShot
449	Acoustic Snare	A.Snare
450	Room Snare	RomSnare
451	Power Snare	PowSnare
452	Electric Snare	E.Snare
453	Analog Snare	AnaSnare
454	Jazz Snare	JazSnare
455	Brush Tap	BrushTap
456	Concert SD	ConcetSD
457	Hand Clap	HandClap
458	Tom	Tom
459	Room Tom	RoomTom
460	Power Tom	PowerTom
461	Electric Tom	ElecTom
462	Analog Tom	AnaTom
463	Brush Tom	BrushTom
464	Closed Hi-hat	ClosedHH
465	Analog Closed Hi-hat	AnCloHH
466	Pedal Hi-hat	PedalHH
467	Open Hi-hat	OpenHH
468	Crash Cymbal	CrashCym
469	Analog Cymbal	AnaCym
470	Ride Cymbal	RideCym
471	China Cymbal	ChinaCym
472	Ride Bell	RideBell
473	Tambourine	Tambouri
474	Splash Cymbal	SplashCy
475	Cowbell	Cowbell
476	Analog Cowbell	AnaCowbl
477	High Bongo	HiBongo
478	Low Bongo	LoBongo
479	Mute Hi Conga	MuHiCnga
480	Open Hi Conga	OpHiCnga
481	Low Conga	LowConga
482	Analog Hi Conga	AnHiCnga
483	Analog Mid Conga	AnMiCnga
484	Analog Low Conga	AnLoCnga
485	High Timbale	HiTimbal
486	Low Timbale	LoTimbal
487	Cabasa	Cabasa
488	Maracas	Maracas

489	Analog Maracas	AnMaraca
490	Short Guiro	ShGuiro
491	Long Guiro	LoGuiro
492	Claves	Claves
493	Mute Cuica	MuCuica
494	Open Cuica	OpCuica
495	Mute Triangle	MuTrgle
496	Open Triangle	OpTrgle
497	Shaker	Shaker
498	Mute Surdo	MuSurdo
499	Open Surdo	OpSurdo
500	Melodic Tom	MeloTom
501	Melodic Tom 2	MeloTom2
502	Synth Drum	SynDrum
503	Rhythm Box Tom	RhythBox
504	Electric Drum	ElecDrum
505	Reverse Cymbal	RevCymb1
SFX		
506	Guitar Fret Noise	FretNoiz
507	Guitar Cutting Noise	GtCtNoiz
508	Acoustic Bass String Slap	BsStSlap
509	Breath Noise	BrthNoiz
510	Flute Key Click	FlKeyClk
511	Seashore	Seashore
512	Rain	Rain
513	Thunder	Thunder
514	Wind	Wind
515	Stream	Stream
516	Bubble	Bubble
517	Bird Tweet	Tweet
518	Bird Tweet 2	Tweet2
519	Dog	Dog
520	Horse Gallop	HouseGlp
521	Telephone Ring	Telephone
522	Telephone Ring 2	Telphon2
523	Door Creaking	DoorCrek
524	Door	Door
525	Scratch	Scratch
526	Wind Chime	WindChim
527	Helicopter	Helicptr
528	Car Engine	CarEngin
529	Car Stop	CarStop
530	Car Pass	CarPass
531	Car Crash	CarCrash
532	Siren	Siren
533	Train	Train
534	Jetplane	Jetplane
535	Starship	Starship
536	Burst Noise	BurtNois
537	Applause	Applause
538	Laughing	Laughing
539	Screaming	Scream
540	Punch	Punch
541	Heart Beat	HeartBet
542	Footsteps	Footstep
543	Gunshot	Gunshot

Voice List

544	Machine Gun	MachnGun
545	Lasergun	Lasergun
546	Explosion	Explosio
Combined Voice		
547	Stereo Piano & Strings Pad	Pn&StrPd
548	Stereo Piano & Choir	Pn&Choir
549	Stereo Piano & Synth Strings	Pn&SyStr
550	Stereo Piano & Warm Pad	Pn&WrmPd
551	Stereo Piano & Soft EP	Pn&SfEP
552	FM Electric Piano	FMEP
553	Digital Piano	DigitlPn
554	E.Piano & Strings	EP&Str
555	E.Piano & Acoustic Guitar	EP&Gtr
556	E.Piano & Vibraphone	EP&Vibra
557	E.Piano 2 & Pad	EP2&Pad
558	E.Piano 2 & Strings	EP2&Str
559	Harpsichord & Stereo Strings	Hrps&Str
560	Music Box & Stereo Strings	MBox&Str
561	Vibraphone & Stereo Strings	Vib&Str
562	Vibraphone Octave	VibraOct
563	Vibraphone & Marimba & Kalimba	Vib&M&K
564	Marimba & Kalimba	Mar&Kal
565	Marimba Delay	MarDelay
566	Xylophone Octave	XylopOct
567	Organ & Stereo Strings	Orgn&Str
568	Stereo Organ & Piano	Orgn&Pno
569	Rock Organ & Strings	RkOr&Str
570	Church Organ & Choir	ChOr&Cho
571	Church Organ & Strings	ChOr&Str
572	Acoustic Guitar & Flute	Gtr&Flut
573	Acoustic Guitar & Clavi	Gtr&Clav
574	24 String Guitar	24StrGtr
575	Steel Guitar & Warm Pad	StGt&Pad
576	Stereo Strings & Horn	Str&Horn
577	Orchestra	Orchestr
578	Full Strings	FullStr
579	Full Strings 2	FullStr2
580	Symphonic	Symphon
581	Stereo Choir & Strings	Cho&Str
582	Stereo Choir & Steel Guitar	Cho&Gtr
583	3 Trumpet Loose	3Trumpet
584	Trombone & Stereo Strings	Tomb&Str
585	3 Trombones Loose	3Trmbone
586	3 Muted Trumpets Loose	3MuTrump
587	Club Brass	ClubBras
588	Brass & Woodwinds	Brs&Wood
589	Woodwinds & Strings	Wood&Str
590	Section Woods Small	WoodSmal
591	Pan Flute & Strings Pad	PnFl&Str
592	Koto & Shamisen	Kto&Sham
593	Flute & Clarinet	Flu&Clar
594	Flute & Oboe	Flu&Oboe
595	Flute & Bassoon	Flu&Bn
596	Flute & Oboe & Clarinet	Fl&Ob&Cl
597	Flute & Clarinet & Bassoon	Fl&Cl&Bn

598	Flute & Oboe & Bassoon	Fl&Ob&Bn
599	Flute Octave	FluteOct
600	Flute & Oboe Octave	Fl&ObOct
601	Flute & Clarinet Octave	Fl&ClOct
602	Oboe & Bassoon	Oboe&Bn
603	Oboe & Clarinet	Ob&Cl
604	Oboe & Clarinet & Bassoon	Ob&Cl&Bn
605	Oboe Octave	OboeOct
606	Oboe & Clarinet Octave	Ob&ClOct
607	Oboe & Bassoon Octave	Ob&BnOct
608	Clarinet & Bassoon	Cl&Bn
609	Clarinet & Oboe Octave	Cl&ObOct
Drums		
610	Standard Set	StandSet
611	Room Set	RoomSet
612	Power Set	PowerSet
613	Electronic Set	ElectSet
614	Analog Set	AnalgSet
615	Jazz Set	JazzSet
616	Brush Set	BrushSet
617	Orchestra Set	OrcheSet
618	SFX Set	SFXSet

Style List

No.	English Name	LCD Display
8BEAT		
1	8Beat Ballad	8BtBld
2	8Beat Piano	8BtPiano
3	8Beat 1	8Beat1
4	Guitar Pop 1	GtPop1
5	8Beat Hip Hop	8BtHiHop
6	8Beat Blues Rock	8BtBluRk
7	8Beat 2	8Beat2
8	Sweet Beat	SweetBt
9	8Beat 3	8Beat3
10	Rhythm&Beat 2	Rhy&Bt2
16BEAT		
11	16Beat 1	16Beat1
12	16Beat Funk 1	16BtFuk1
13	16Beat Ballad 1	16BtBld1
14	16Beat R&B	16BtR&B
15	Pop 16Beat 1	Pop16Bt1
16	16Beat Funk 2	16BtFuk2
17	16Beat Dance	16BtDanc
18	Pop 16Beat 2	Pop16Bt2
19	16Beat 2	16Beat2
20	Pop 16Beat 3	Pop16Bt3
21	Pop 16Beat 4	Pop16Bt4
22	Modern 16Beat	Modr16Bt
23	16Beat Hot	16BtHot
24	16Beat Modern	16BtModr
25	16Beat Funk 3	16BtFuk3
26	16Beat 3	16Beat3
27	Cool Beat	CoolBeat
28	16Beat Ballad 2	16BtBld2
29	16Beat 4	16Beat4
30	Pop Shuffle	PopShfl
POP & BALLAD		
31	Pop Rock 1	PopRock1
32	Pop Dance 1	PopDanc1
33	Pop Fusion	PopFusn
34	Analog Night 1	AnalgNt1
35	6/8 Pop	6/8Pop
36	Brit. Pop 1	BritPop1
37	Brit. Pop 2	BritPop2
38	Pop Hit	PopHit
39	Fusion Shuffle	FusShfl
40	Analog Night 2	AnalgNt2
41	Guitar Pop 3	GtPop3
42	Pop Beat	PopBeat
43	Soft Beat	SoftBeat
44	60's Pop	60'sPop
45	Sting Latin	StigLatn
46	R&B Ballad 1	R&BBld1
47	Guitar Ballad	GtBallad
48	Ballad Rock	BaldRock
49	Piano Pop	PianoPop
50	Soft Ballad	SoftBald

51	Natural Ballad	NatuIBld
52	Love Ballad	LoveBald
53	Easy Ballad	EasyBald
54	Miami Folk	MiamiBld
55	Slow Ballad	SlowBald
56	Folk Ballad	FolkBald
57	Pop Ballad 1	PopBald1
58	Pop Ballad 2	PopBald2
59	EP Ballad	EPBallad
60	New R&B Ballad	NewRBBld
ROCK		
61	Rock	Rock
62	New Wave	NewWave
63	Ska	Ska
64	Pop Rock 2	PopRock2
65	Slow Rock	SlowRock
66	70's Rock&Roll	70'sRock
67	Folk Rock	FolkRock
68	Soft Rock	SoftRock
69	Old Rock	OldRock
70	Easy Rock	EasyRock
71	New Shuffle	NewShfl
72	Rock Hip Hop	RkHipHop
73	Rock&Roll 1	R'N'R1
74	Rock Shuffle	RockShfl
75	Rock&Roll 2	R'N'R2
BALLROOM		
76	Tango 1	Tango1
77	Spain Matador	Matador
78	Twist 1	Twist1
79	Twist 2	Twist2
80	Big Band Fox	BandFox
81	Tango 2	Tango2
82	Slow Fox	SlowFox
83	Slow Waltz 1	SlowWlz1
84	Swing Fox	SwingFox
85	Salsa 1	Salsa1
86	Cha Cha 1	ChaCha1
87	Cha Cha 2	ChaCha2
88	Beguine 1	Beguine1
89	Beguine 2	Beguine2
90	Rumba 1	Rumba1
91	Samba 1	Samba1
92	Samba 2	Samba2
93	Jive	Jive
94	Fox Trot	FoxTrot
DANCE		
95	Techno 1	Techno1
96	Hip Hop 1	HipHop1
97	House 1	House1
98	Down Beat	DownBeat
99	Progressive	Progress
100	Rap 1	Rap1
101	Disco	Disco

Style List

102	70's Disco	70'sDisc
103	Club Dance	ClubDanc
104	Euro Dance	EuroDanc
105	Garage	Garage
SOUL & FUNK		
106	Funk 1	Funk1
107	Classic Funk	ClasFunk
108	Jay R&B	JayR&B
109	Gospel Swing	GopSwing
110	Gospel	Gospel
111	Funk 2	Funk2
112	Electric Funk	ElecFunk
113	Groove Funk	GrooveFk
114	Rubber Funk	RubberFk
115	Cool Funky	ColFunky
116	Jazz Funk	JazzFunk
117	Groove	Groove
118	Soul	Soul
119	Hip Hop Soul	HipHopSl
120	Hip Hop Beat	HipHopBt
121	R&B	R&B
122	British Soul Pop	BritSoul
123	Latin Jazz 1	LatinJz1
124	Big Band 1	BigBand1
125	Dixieland 1	Dixland1
126	Guitar Swing 1	GtSwing1
127	Broadway Big Band	BwayBand
128	Swing	Swing
129	Latin Jazz 2	LatinJz2
130	Fusion	Fusion
131	Acid Jazz	AcidJazz
132	Cool Jazz Ballad	CoolJzBd
133	Swing Shuffle	SwingSfl
134	Big Band Medium	BandMid
135	Ragtime	Ragtime
COUNTRY		
136	Country Pop 1	CntyPop1
137	Bluegrass 1	Blugras1
138	8Beat Country	8BtCnty
139	Modern Country	ModrCnty
140	Country Pop 2	CntyPop2
141	Bluegrass 2	Blugras2
142	2/4 Country	2/4Cntry
143	Country Quick Steps	QuickStp
144	Country Folk	CntyFolk
145	Country Shuffle	CnyShuff
LATIN & LATIN DANCE		
146	Samba 3	Samba3
147	Bossa Nova	BosaNova
148	Latin	Latin
149	New Reggae	NewRegga
150	Reggae Dance	DanRegga
151	Paso Doble	Pasodobl
152	Lite Bossa	LteBossa

153	Latin Rock	LatinRck
154	Beguine 3	Beguine3
155	Slow Bolero	SlBolero
156	Disco Samba	DscSamba
157	Mambo	Mambo
158	Meneito	Meneito
159	Rumba 2	Rumba2
160	Rumba 3	Rumba3
161	Lambada	Lambada
162	Pop Cha Cha 1	PChaCha1
WALTZ & TRADITIONAL		
163	Waltz	Waltz
164	Old Waltz	OldWaltz
165	English Waltz	EngWaltz
166	German Waltz	GemWaltz
167	Italian Mazurka	ItaMazuk
168	Mexico Waltz	MexWaltz
169	Vienna Waltz	VinaWltz
170	Slow Waltz 2	SlwWltz2
171	Jazz Waltz	JazzWltz
172	Polka	Polka
173	6/8 March	6/8March
174	German Polka	GemPolka
175	Party Polka	PtyPolka
176	Army March	ArmMarch
177	March	March
178	US March	USMarch
179	French Musette	FMusette
180	Mazurka	Mazurka
WORLD		
181	Enka Ballad	EnkaBald
182	Laendler	Laendler
183	Hawaiian	Hawaiian
184	Sirtake	Sirtake
185	Dangdut	Dangdut
186	6/8 Flipper	6/8Flipp
187	New Age	NewAge
188	Tarantella	Tarantel
189	Scottish	Scottish
190	Norteno	Norteno
PIANIST		
191	Pianist 1	Pianist1
192	Pianist 2	Pianist2
193	Pianist 3	Pianist3
194	Piano Rock	PianoRk
195	Pop Bossa	PopBossa
196	Piano Beat	PianoBt
197	Piano Bar	PianoBar
198	Blues	Blues
199	Pop Waltz	PopWaltz
200	6/8 Ballad	6/8Bald

Song List

No.	English Name	LCD Display
FOLK & COUNTRY		
1	Toccata	Toccata
2	Carry Me Back To Old Virginy	Virginy
3	El Condor Pasa	ElCondor
4	Wedding March	Wedding
5	Traumerei	Traumere
6	Greensleeves	Sleeves
7	Home Sweet Home	SwetHome
8	Aloha Oe	AlohaOe
9	Long Long Ago	LongAgo
10	Heidenroslein	Heidenro
11	Die Lorelei	Lorelei
12	My Darling Clementine	Clemtine
13	Over The Waves	OverWave
14	Gwine To Run All Night	Gwine
15	Oh! Susanna	Susanna
16	Symphony No.6 "Pathetic"	Sympony6
17	Prelude Op.28 No.15	Prelude
18	The House Of The Rising Sun	RiseSun
GOLDEN & POP		
19	Valse Des Fleurs	Fleurs
20	Fruhlingsstimmen	Fruhling
21	Frohlicher Landmann	Landmann
22	Are You Lonesome Tonight?	Lonesome
23	Toy Symphony	ToySymph
24	Auld Lang Syne	LangSyne
25	Ave Maria	AveMaria
26	Tales Of Hoffman	Hoffman
27	La Donne Mobile	DoneMble
28	Serenata	Serenata
29	Bridal March	Bridal
30	Can'T Help Fallin' In Love	InLove
31	Chanson Du Toreador	Toreador
32	Danny Boy	DannyBoy
33	Ich Liebe Dich	LieDich
34	Wiegenlied 2	Wieglied2
35	Spanish Serenade	Serenade
36	Piano Concerto	Concerto
37	Piano Concerto 2	Concrto2
38	Madame Butterfly	Madame
39	Invitation To The Dance	ToDance
40	Wiegenlied 3	Wieglied3
41	Jingle Bells	JingBell
42	Joy To The World	JoyWorld
43	La Paloma	LaPaloma
44	My Bonnie	MyBonnie
45	La Reine De Saba	Saba
46	La Cucaracha	Cucarach
47	Little Brown Jug	BrownJug
48	Battle Hymne Of The Republic	BatlHyme
49	Yellow Rose Of Texas	YellRose
50	The Wabash Cannon Ball	CannBall

No.	English Name	LCD Display
51	Annie Laurie	AnnieLa
52	Turkish March	Turkish
53	An Die Musik	Musik
54	Lieder Ohne Worte Op.62 No.6	Lieder
55	Red River Valley	RedRiver
56	Die Forelle	Forelle
57	Symphony No. 94 "Suprise"	No. 94
58	Polonaise	Polonais
59	Rondeau	Rondeau
60	Moments Musicaux	Musicaux
61	Silent Night	SltNight
62	Moldau	Moldau
63	Summertime	Summer
64	Dreaming Of Home And Mother	Dreaming
65	Ring Ring De Banjo	DeBanjo
66	Der Lindenbaum	DerLinde
67	Zigeunerweisen	Zigeuner
68	The Maiden's Prayer	Prayer
69	Fur Elise	FurElise
70	Der Freischutz	DerFreis
71	Maria! Mari!	Maria!
72	Heidenroslein	Heidenro
73	Symphony No.5	Symphony
74	Anitra's Dance	Anitra
75	Sadko-Chanson Indoue	Chanson
76	Orpheus	Orpheus
CLASSICAL		
77	William Tell Overture	Overture
78	A Lover's Concerto	Concerto
79	Air For The G-String	G-String
80	An Der Shonen Blauen Donau	Donau
81	Auf Flugeln Des Gesanges	Gesanges
82	Beautiful Dreamer	Dreamer
83	Dance Des Mirlitons	Mirliton
84	Etude Op. 10 No. 3	Etude3
85	Gavotte	Gavotte
86	Hungarian Dances No. 5	Hungaian
87	From The New World	NewWorld
88	Serenata Rimpiant	Serenata
89	Triumphal March	Trimphal
90	The Skaters Waltz	Skaters
91	O Sole Mio	OSoleMio
92	Waves Of The Danube	Danube
93	Santa Lucia	SantaLuc
94	Solveig's Song	Solveig
95	Piano Sonatan No. 8 In C Minor (Pathetique)	Patheque
96	Brahms Waltz	BrmsWltz
97	Aida	Aida
98	Carmen-Prelude	Carmen
99	L'Arlesienne	L'Arlesi
100	Ungarische Tanz	Ungaris
101	Mazurka	Mazurka

Song List

No.	English Name	LCD Display
102	Pizzicato Polka	Polka
103	Menuett	Menuett
104	Rigoletto	Rigoletto
105	Serenade	Serenade
106	Song Without Words	SongNoWd
107	Swan	Swan
108	The Dying Swan	DyingSwn
109	Swan Lake Valse	SwnWalse
110	The Happy Farmer	HpFarmer
111	The Sleeping Beauty	SleepBty
112	La Traviata	LaTravia
113	Wiegenlied	Wiegenli
114	Mov. 2 Adagio Non Troppo Piano Sonata No. 9 In D	Sonata9
115	Piano Sonata No. 11 In A	Sonata11
116	Prelude In C	Prelude
117	Chinese Dance	ChDance
118	Emperor Waltz	Emperor
119	March Militaire	Militair
120	Symphony No. 40	Symphony
PIANO		
121	Hanon Piano Fingering 1	Hanon1
122	Hanon Piano Fingering 2	Hanon2
123	Hanon Piano Fingering 3	Hanon3
124	Hanon Piano Fingering 4	Hanon4
125	Hanon Piano Fingering 5	Hanon5

No.	English Name	LCD Display
126	Basic Tutorial Beyer Piano 12	Beyer12
127	Basic Tutorial Beyer Piano 13	Beyer13
128	Basic Tutorial Beyer Piano 14	Beyer14
129	Basic Tutorial Beyer Piano 15	Beyer15
130	Basic Tutorial Beyer Piano 18	Beyer18
131	Cuckoo	Cuckoo
132	Basic Tutorial Beyer Piano 21	Beyer21
133	Basic Tutorial Beyer Piano 29	Beyer29
134	Butterfly	Buterfly
135	Basic Tutorial Beyer Piano 45	Beyer45
136	Christmas Eve	XmasEve
137	Basic Tutorial Beyer Piano 50	Beyer50
138	Basic Tutorial Beyer Piano 52	Beyer52
139	Basic Tutorial Beyer Piano 55	Beyer55
140	Basic Tutorial Beyer Piano 59	Beyer59
141	Beyer Eight Degrees Jump Etude	BeyrJump
142	Basic Tutorial Beyer Piano The Scale Of C Major	BeyerC
143	Basic Tutorial Beyer Piano 65	Beyer65
144	Basic Tutorial Beyer Piano 66	Beyer66
145	Old Folks At Home (Piano)	OldFolk2
146	Basic Tutorial Beyer Piano The Scale Of G Major	BeyerG
147	Basic Tutorial Beyer Piano 70	Beyer70
148	Basic Tutorial Beyer Piano 72	Beyer72
149	Basic Tutorial Beyer Piano 73	Beyer73
150	Basic Tutorial Beyer Piano 74	Beyer74

Demo List

No.	English Name	LCD Display
1	Demo	Demo
2	Bossa Nova	BosaNova
3	Fusion	Fusion
4	Jazz	Jazz
5	Funk	Funk

Album List

No.	English Name	LCD Display
1	13 Jours en france	13France
2	A lover's concerto	Concerto
3	A time for us	Timeus
4	A whiter shade of pale	WhtShade
5	Adios	Adios
6	After you've gone	U'veGone
7	Again	Again
8	Agua de beber	AguaBebr
9	Air for the G-string	G-String
10	All alone am I	AloneAml
11	All his children	Children
12	All shook up	ShookUp
13	Aloha oe	AlohaOe
14	Always in my heart	MyHeart
15	Amapola	Amapola
16	Amazing grace	AmzGrace
17	Amor	Amor
18	An der shonen blauen donau	Donau
19	Anastasia	Anastasi
20	Angel	Angel
21	Angustia	Angustia
22	Annie laurie	AnnieLa
23	Are you lonesome tonight?	Lonesome
24	Arirang	Arirang
25	Around the world	AroWorld
26	Auf flugeln des gesanges	Gesanges
27	Auld lang syne	LangSyne
28	Ave maria	AveMaria
29	Bad moon rising	BadMoon
30	Battle hymne of the republic	BatlHyme
31	Beautiful dreamer	Dreamer
32	Besame mucho	Besame
33	Beyond the reef	BeyndRef
34	Bibbidi bobbidi boo	Bibbidi
35	Bittersweet samba	Bitsweet
36	Blue christmas	BlueXmas
37	Blue tango	BluTango
38	Blueberry hill	Blueberry
39	Born free	BornFree
40	Brazil	Brazil
41	Breaking up is hard to do	BreakUp
42	Bridal march	Bridal
43	Bridge over troubled water	Bridge
44	Bus stop	BusStop
45	Buttons and bows	BottnBow
46	Cachito	Cachito
47	Canadian sunset	CaSunset
48	Can't help fallin' in love	InLove
49	Carry me back to old virginny	Virginny
50	Chanson D'amour	Chanson
51	Chanson du toreador	Toreador
52	Charade	Charade

No.	English Name	LCD Display
53	Chattanooga shoe shine boy	ShoeBoy
54	Clelito lindo	CleLindo
55	Close to you	CloseYou
56	Constantly	Constant
57	Cryin' in the chapel	CryChapl
58	Dance des mirlitons	Mirliton
59	Danny boy	DannyBoy
60	Dark eyes	DarkEyes
61	Diana	Diana
62	Die lorelei	Lorelei
63	Do re mi	DoReMi
64	Dominique	Dominiqu
65	Dream	Dream
66	Dream tango	DremTngo
67	Ebb tide	EbbTide
68	Edelweiss	Edelweis
69	El bimbo	ElBimbo
70	El condor pasa	ElCondor
71	Eso es el amor	EsAmor
72	Esperanza	Esperanz
73	Etude op.10 no.3	Etude3
74	Fascination	Fascina
75	Feelings	Feelings
76	Five hundred miles	500Miles
77	Five minutes more	FiveMore
78	Fly me to the moon	FlyMoon
79	For ever we konw	WeKnow
80	For the good times	GoodTime
81	Frohlicher landmann	Landmann
82	Fruhlingsstimmen	Fruhling
83	Gavotte	Gavotte
84	Green fields	Fields
85	Green, green grass of home	GreenGrS
86	Greensleeves	Sleeves
87	Gwine to run all night	Gwine
88	Gypsy moon	GypsMoom
89	Happy birthday to you	Birthday
90	Harbour light	Harbour
91	Harlem nocturne	Harlem
92	Hasta manana	HasMana
93	Heidenroslein	Heidenro
94	Her bright smile haunts me still	HerSmile
95	Hernando's hideaway	Hideaway
96	Hey jude	HeyJude
97	Historia de un amor	Historia
98	Home on the range	HomeRnge
99	Home sweet home	SwetHome
100	Hound dog	HoundDog
101	How deep is your love	DeepLove
102	Hungarian dances no.5	Hungaian
103	Hurry sundown	Sundown
104	Hymne a l'amour	L'amour

Album List

No.	English Name	LCD Display
105	I don't hurt any more	HurtMore
106	I kiss your little hand, madame	kissyour
107	I love you much too much	LoveYou
108	I need you now	INeedYou
109	I really don't want to know	DontKnow
110	I went to your wedding	UrWeding
111	If	If
112	If I can dream	IfDream
113	If I give my heart to you	HeartYou
114	In the mood	InMood
115	It's almost tomorrow	Tomorrow
116	It's been a long, long time	LongTime
117	Jambalaya	Jambalay
118	Jazz'n' samba	JazSamba
119	Jeanie with the light brown hair	Jeanie
120	Jingle bells	JingBell
121	Johnny B. Goode	B.Goode
122	Joy to the world	JoyWorld
123	Jungle drums	JungleDm
124	Kaiser walzer	Kaiser
125	Keep searchin'	Searchin
126	Killing me softly with his song	HisSong
127	Kiss	Kiss
128	Kiss of fire	KissFire
129	La chanson D'orpee	D'Orpee
130	La contessa scalza	Scalza
131	La cucaracha	Cucarach
132	La donne mobile	DoneMble
133	La mer	LaMer
134	La novia	LaNovia
135	La paloma	LaPaloma
136	La playa	LaPlaya
137	La ragazza di bube	Bube
138	La reine de saba	Saba
139	L'amour est blue	L'amour
140	Lara's theme from "Doctor zhivago"	Zhivago
141	Last waltz	LastWltz
142	Les feuilles mortes	Feuilles
143	Let's get together	Together
144	Little brown jug	BrownJug
145	Long, long ago	LongAgo
146	Love is a many-splendored thing	SplndLov
147	Love me with all your heart	AllHeart
148	Love story	LovStory
149	Lullaby of birdland	Birdland
150	Mama inez	Mamalnez
151	Mambo No. 5	MamboNo5
152	Mambo No. 8	MamboNo8
153	March militaire	Militair
154	Maria elena	MriaElna
155	Maria, my own	Maria
156	Massachusetts	Maschuse

No.	English Name	LCD Display
157	Menuet	Menuet
158	Miami beach rumba	MamiRmba
159	Misty	Misty
160	Mockin'bird hill	BirdHill
161	Moliendo Coffee	Coffee
162	Moody river	ModyRivr
163	Moon river	MoonRivr
164	Moonlight serenade	Moonligt
165	More	More
166	Moscow nights	Moscow
167	Moulin rouge	MoulinRg
168	Mr.lonely	MrLonely
169	My bonnie	MyBonnie
170	My darling clementine	Clementine
171	My old kentucky home	Kentucky
172	My shawl	MyShawl
173	My way	MyWay
174	Nature boy	NaturBoy
175	Never on sunday	NeverSun
176	New world	NewWorld
177	Night fall	NigtFall
178	Nobody knows the trouble I've seen	Nobody
179	Noche de tokyo	Tokyo
180	Nocturne	Nocturne
181	O sole mio	OSoleMio
182	Oh! Carol	Oh!Carol
183	Oh! Susanna	Susanna
184	Oh, bury me not on the lone prairie	Prairie
185	Oh, what a beautiful morning	OMorning
186	Old black joe	BlackJoe
187	Old dog tray	DogTray
188	Old folks at home	OldFolks
189	On a little bamboo bridge	BambooBg
190	On a tropic night	TrpicNgt
191	On london bridge	OnBridge
192	On the beach at bali-bali	BaliBali
193	One way ticket to the blues	OWTickets
194	Only you	OnlyYou
195	Over the rainbow	Rainbow
196	Over the waves	OverWave
197	Par un beau matin d'ete	BeauMatn
198	Patricia	Patricia
199	Penelope	Penelope
200	Perfidia	Perfidia
201	Petite fleur	Fleur
202	Piacer d'amor	Piacer
203	Pizzicato polka	PizzPoka
204	Pretend	Pretend
205	Proud mary	ProdMary
206	Quien sera	QuieSera
207	Quizas, Quizas, Quizas	Quizas
208	Raindrops keep fallin' on my head	Raindrop

No.	English Name	LCD Display
209	Ramona	Ramona
210	Red river valley	RedRiver
211	Rhythm of the rain	RhymRain
212	Rock around the clock	Rock
213	Romance de l'amour	Romance
214	Royal garden blues	RoyalBlu
215	Sail along silv'ry moon	SilyMoon
216	Sailing	Sailing
217	San Francisco	Francico
218	Sans toi mamie	ToiMami
219	Santa claus is comin' to town	SantClau
220	Santa lucia	SantaLuc
221	Scarborough fair	Scarboro
222	Sealed with a kiss	Sealed
223	Sentimental journey	Journey
224	Serenade	Serenade
225	Serenata rimpiant	Serenata
226	Siboney	Siboney
227	Silent night	SitNight
228	Singin' in the rain	SingRain
229	Sleepy Lagoon	Lagoon
230	Sloop John B	JohnB
231	Smoke gets in your eyes	SmokeEye
232	So nice	SoNice
233	Solamente una ves	Salament
234	Somebody bad stole de wedding bell	StoleBel
235	Songs of spring	SngSprig
236	Speak softly love	SoftLove
237	ST. Louis blues	ST.Louis
238	Stranger in paradise	Paradise
239	Strangers in the night	Stranger
240	Summer holiday	Holiday
241	Summertime	Summer
242	Summertime in venice	Venice
243	Sunrise, sunset	Sunrise
244	Superstar	Superstr
245	Sweet and gentle	SwetGtle
246	Taboo	Taboo
247	Take me home, country roads	CntyRoad
248	Tales of hoffman	Hoffman
249	Tammy	Tammy
250	Tango notturno	TangoNot
251	Tennessee waltz	Tennesse
252	The blue-bells of scotland	BlueBell
253	The breeze and I	Breeze&I
254	The dying swan	DyingSwn
255	The end of the world	EndWorld
256	The exodus song	Exodus
257	The eyes of love	EyesLove
258	The girl from ipanema	Ipanema
259	The great pretender	Pretend
260	The house of the rising sun	RiseSun

No.	English Name	LCD Display
261	The impossible dream	ImDream
262	The loco-motion	TheLoco
263	The longest day	Longest
264	The peanut vendor	Vendor
265	The river of no return	NoReturn
266	The shadow of your smile	UrSmile
267	The skaters waltz	Skaters
268	The sound of silence	Silence
269	The wabash cannon ball	CannBall
270	The way we were	TheWay
271	This land is your land	YourLand
272	Those were the days	TheDays
273	Three coins in the fountain	Fountain
274	Tico-tico	TicoTico
275	Tie a yellow ribbon'round the ole oak tree	YeRibbon
276	To love again	LovAgain
277	Toccata	Toccata
278	Tom dooley	TomDoley
279	Tombe la neige	LaNeige
280	Top of the world	TopWorld
281	Toy symphony	ToySymph
282	Traumerei	Traumere
283	Triumphal march	Trimphal
284	Tu ne sais pas aimer	TuAimer
285	Turkey in the straw	TukyStaw
286	Un buco nella sabbia	Sabbia
287	Una lacrima sul viso	Lacrima
288	Unchained melody	Melody
289	Valse des fleurs	Fleurs
290	Vaya con dios	VayaDios
291	Venus	Venus
292	Washington square	Washnton
293	Waves of the danube	Danube
294	Wedding march	Wedding
295	When you and I were young, maggie	YoungMag
296	Where the boys are	WhereBoy
297	Whispering hope	Whisper
298	Wiegenlied	Wieglied
299	Wiegenlied 2	Wieglid2
300	Without you	WithoutU
301	Wonderland by night	WonNight
302	Words	Words
303	Y.M.C.A.	Y.M.C.A.
304	Yellow rose of texas	YellRose
305	Yesterday	Yestday
306	Yesterday once more	OnceMore
307	You always hurt the one you love	HurtLove
308	You are my sunshine	Sunshine
309	You mean everything to me	MeanToMe
310	Your love is mine	LoveMine

Chord List

Chord Name (Abbreviation)	Normal Voicing	Chord	Display
Major [M]	1-3-5	C	C
Major sixth [6]	1-(3)-5-6	C6	C6
Major seventh [M7]	1-3-(5)-7	CM7	CM7
Major seventh sharp eleventh [M7#11]	1-(2)-3-#4-(5)-7	CM7#11	CM7#11
Major add ninth [Madd9]	1-2-3-5	Cmadd9	CM(9)
Major ninth [M9]	1-2-3-(5)-7	CM9	CM7(9)
Major sixth add ninth [6 9]	1-2-3-(5)-6	C6 9	C6(9)
Augmented [aug]	1-3-#5	Caug	Caug
Minor [m]	1-b3-5	Cm	Cm
Minor sixth [m6]	1-b3-5-6	Cm6	Cm6
Minor seventh [m7]	1-b3-(5)-b7	Cm7	Cm7
Minor seventh flatted fifth [m7b5]	1-b3-b5-b7	Cm7b5	Cm7b5
Minor add ninth [madd9]	1-2-b3-5	Cmadd9	Cm(9)
Minor ninth [m9]	1-2-b3-(5)-b7	Cm9	Cm7(9)
Minor eleventh [m11]	1-(2)-b3-4-5-(b7)	Cm11	Cm7(11)
Minor major ninth [mM7]	1-b3-(5)-7	CmM7	CmM7
Minor major ninth [mM9]	1-2-b3-(5)-7	CmM9	CmM7(9)
Diminished [dim]	1-b3-b5	Cdim	Cdim
Diminished seventh [dim7]	1-b3-b5-6	Cdim7	Cdim7
Seventh [7]	1-3-(5)-b7	C7	C7
Seventh suspended fourth [7sus4]	1-4-5-b7	C7sus4	C7sus4
Seventh flatted fifth [7b5]	1-3-b5-b7	C7b5	C7b5
Seventh ninth [7 9]	1-2-3-(5)-b7	C7 9	C7(9)
Seventh sharp evelenth [7#11]	1-2-3-#4-(5)-b7 or 1-(2)-3-#4-5-b7	C7#11	C7(#11)
Seventh thirteenth [7 13]	1- 3-(5)-6-b7 or 2- 3-5-6-b7	C7 13	C7(13)
Seventh flatted ninth [7b9]	1-b2-3-(5)-b7	C7b9	C7(b9)
Seventh flatted thirteenth [7b13]	1-3-5-b6-b7	C7b13	C7(b13)
Seventh sharp ninth [7#9]	(1)-#2-3-(5)-b7	C7#9	C7(#9)
Major seventh augmented [M7aug]	1-3-#5-7	CM7aug	CM7aug
Seventh augmented [7aug]	(1)-3-#5-b7	C7aug	C7aug
Suspended fourth [sus4]	1-4-5	Csus4	Csus4
One plus two plus five [1+2+5]	1-2-5	C1+2+5	C

MIDI Implementation Chart

Function		Transmitted	Recognized	Remarks
Basic Channel	Default	1ch	1-16ch	
	Changed	1-16ch	1-16ch	
Mode	Default	x	3	
	Messages	x	x	
	Altered	*****	x	
Note Number	Note	0—127	0—127	
	:True voice	*****	0—127	
Velocity	Note on	o 9nH,V=1-127	o 9nH,V=1-127	
	Note off	x (9nH,V=0)	o(9nH,V=0; 8nH,V=0-127)	
After Touch	key's	x	x	
	Ch's	x	x	
Pitch Bend		x	o	
Control Change	0	o	o	Bank Select
	1	o	o	Modulation
	5	x	o	Portamento Time
	6	o	o	Data Entry
	7	o	o	Volume
	10	x	o	Pan
	11	x	o	Expression
	64	o	o	Sustain Pedal
	65	x	o	Portamento ON/OFF
	66	o	o	Sostenuto Pedal
	67	o	o	Soft Pedal
	80	x	o	Reverb Program
	81	x	o	Chorus Program
	91	o	o	Reverb Level
	93	o	o	Chorus Level
	120	o	o	All Sound Off
	121	x	x	Reset All Controllers
123	o	o	All Notes Off	
Program Change	:true	*****	0—127	
System Exclusive		x	o	
System Common	:SongPosition	x	x	
	:Song Select	x	x	
	:Tune	x	x	
System Real Time	:Clock	o	x	
	:Commands	x *1	x	
Aux Messages	:LOCAL ON/OFF	x	x	
	:Active sense	x	o	
	:Reset	x	x	
Notes: *1 When the accompaniment is started, an FAH message is transmitted. When accompaniment is stopped, an FCH message is transmitted.				

- Mode 1: OMNI ON, POLY
- Mode 2: OMNI ON, MONO

- Mode 3: OMNI OFF, POLY
- Mode 4: OMNI OFF, MONO

- x: NO
- o: YES



We love music!

WEEE-Declaration

Your product is designed and manufactured with materials and components of high quality, which are recyclable and can be reused.

The symbol means that your product should be disposed of separately from household waste when it reaches its end of life.

Please dispose of this equipment at your local collection point or recycling center.

Please help to protect the environment in which we all live.

Intellectual property /Copyright

All specifications and appearances are subject to change without notice.

All information was correct at time of printing. Musikhaus Kirstein GmbH does not guarantee for the accuracy or completeness of any description, photograph or statement contained in this manual.

Printed colours and specifications may vary slightly from product. Products from Musikhaus Kirstein GmbH products are only sold through authorized dealers. Distributors and dealers are not agents of

Musikhaus Kirstein GmbH and have no authority to bind Musikhaus Kirstein GmbH legally in any way.

This manual is protected by copyright. Any copying or reprint, even in excerpts, is only allowed with written consent of Musikhaus Kirstein GmbH.

The same applies to reproduction or copying of images, even in altered form.



Musikhaus Kirstein GmbH
Bernbeurener-Str.11
D-86956 Schongau
Tel.0049-8861-909494-0
Fax:0049-8861-909494-19
www.kirstein.de



X-Keyboardständer einstrebig

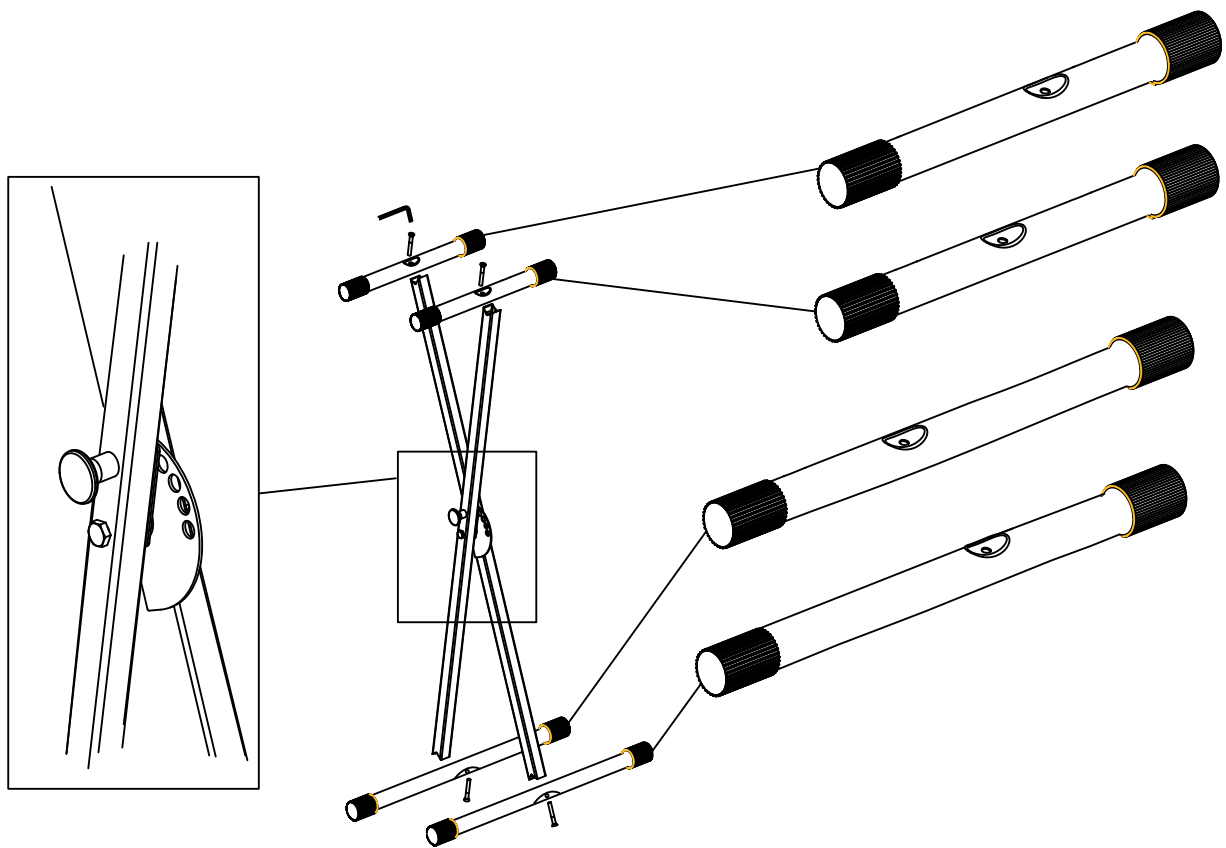

 **KIRSTEIN.de**
We love music!

Musikhaus Kirstein GmbH
Bernbeurener Str. 11
86956 Schongau
www.kirstein.de

Art. 00009812 /00062730
Version 10/2019