

00016122 Version 8/2019

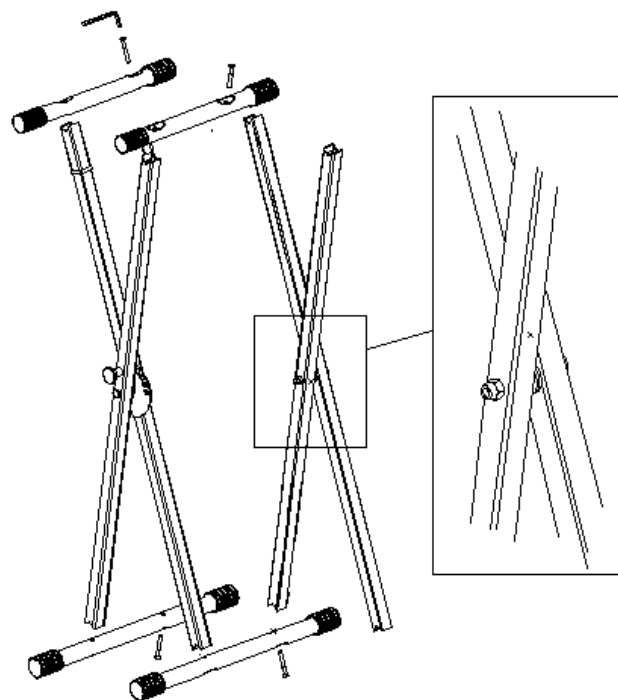

Classic Cantabile KH-238 Kopfhörer HiFi dynamisch

ArtNr.: 00016331

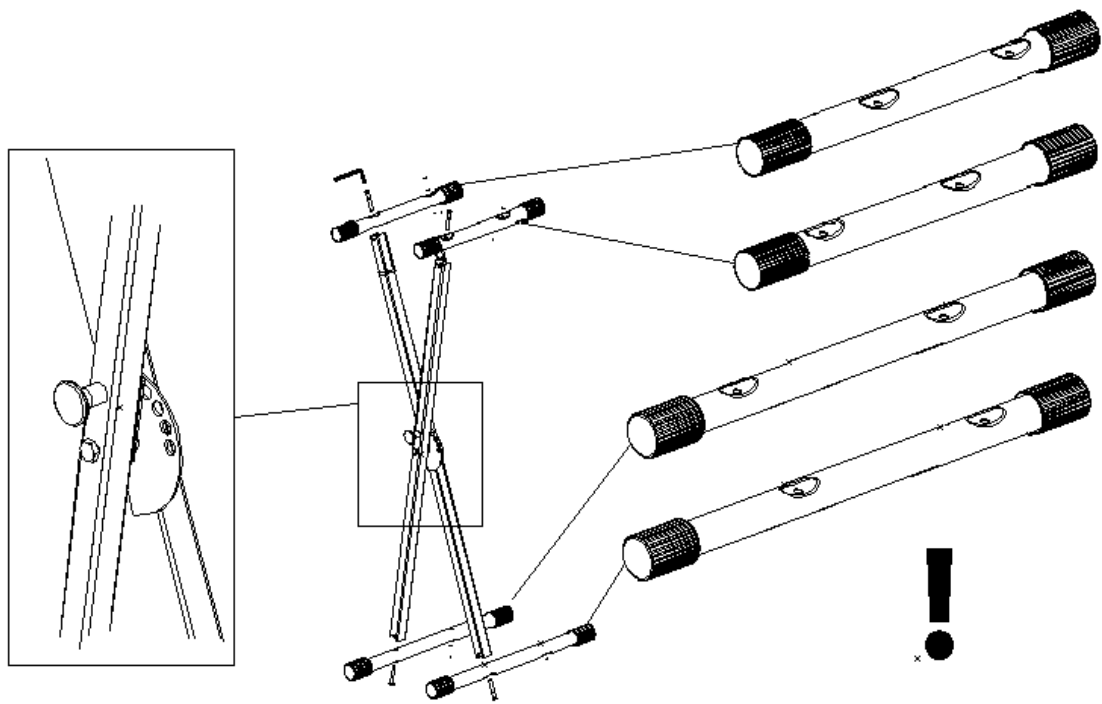

Bedienungsanleitung

Version: 10.2024

Vielen Dank, dass Sie sich für dieses Produkt entschieden haben. Um sicherzustellen, dass Sie mit dem Classic Cantabile Kopfhörer voll und ganz zufrieden sind, lesen Sie sorgfältig und verstehen Sie diese Bedienungsanleitung, bevor Sie unser Produkt verwenden. Bewahren Sie diese Bedienungsanleitung an einem sicheren Ort auf. Die Bedienungsanleitung muss an alle nachfolgenden Anwender weitergegeben werden.



Bedienungsanleitung beachten!



WARNUNG

Mit dem Signalwort **WARNUNG** sind die Gefahren gekennzeichnet, die ohne Vorsichtsmaßnahmen zu schweren Verletzungen führen können.



HINWEIS

Mit dem Signalwort **HINWEIS** sind allgemeine Vorsichtsmaßnahmen gekennzeichnet, die im Umgang mit dem Produkt beachtet werden sollen.



HINWEIS

Bilder und Bildschirmdarstellungen in dieser Bedienungsanleitung können vom Erscheinungsbild des tatsächlichen Produkts geringfügig abweichen, solange dies keine negativen Auswirkungen auf die technischen Eigenschaften und Sicherheit des Produkts hat.



HINWEIS

Alle personenbezogenen Formulierungen in dieser Bedienungsanleitung sind geschlechtsneutral zu betrachten.

Diese Bedienungsanleitung gilt für Personen, die von einer für ihre Sicherheit verantwortlichen Person beaufsichtigt oder in die Bedienung des Gerätes eingewiesen wurden und nachgewiesen haben mit dem Gerät umgehen zu können.



WARNUNG

**Kinder sollten beaufsichtigt werden, um sicherzustellen, dass sie nicht mit dem Kopfhörer spielen.
Der Kopfhörer ist kein Spielzeug**

Alle Informationen in dieser Bedienungsanleitung wurden nach bestem Wissen und Gewissen kontrolliert. Weder Autor noch Herausgeber können jedoch für Schäden haftbar gemacht werden, die in Zusammenhang mit der Verwendung dieser Bedienungsanleitung stehen.

Sonstige, in diesem Dokument aufgeführte Produkt-, Marken- und Unternehmensbezeichnungen können die Warenzeichen ihrer jeweiligen Eigentümer sein. Die Einhaltung sämtlicher anwendbarer Urheberrechtsgesetze liegt in der Verantwortung des Anwenders dieses Dokuments.

Detaillierte Sicherheitshinweise:

HINWEIS

- Lesen Sie diese Anweisungen und bewahren Sie diese Anleitung auf.
- Beachten Sie alle Warnungen. Befolgen Sie alle Anweisungen.
- Verwenden Sie dieses Gerät nicht im Wasser.
- Reinigen Sie das Gerät nur mit einem trockenen Tuch.
- Legen Sie das Gerät nicht in auf Wärmequellen wie Heizkörpern, Öfen oder andere Geräte, die Wärme erzeugen.
- Achten Sie auf die Lautstärke! Hören mit zu hohem Lautstärkepegel kann Ihr Gehör dauerhaft schädigen.
- Wenden Sie sich bezüglich aller Reparatur- /Wartungsarbeiten an qualifiziertes Servicepersonal. Öffnen Sie das Gerät bzw. das Gehäuse nicht eigenmächtig. Eine Wartung ist erforderlich, wenn das Gerät auf irgendeine Weise beschädigt wurde, z. B. wenn das Kabel beschädigt ist, Flüssigkeit verschüttet wurde oder das Gerät Regen oder Feuchtigkeit ausgesetzt war, nicht ordnungsgemäß funktioniert.



Beschreibung:

Funktion:

Der Kopfhörer kann mit jedem Abspielgerät (z.B. CD-Player) als auch Instrument (z.B. E-Drumset, Keyboard oder Piano) verbunden werden. Hierbei ist je nach Buchse lediglich auf den Einsatz der korrekten 3,5 mm Klinke oder der 6,3 mm Klinke des Adapters zu achten.(Adapter liegt bei)

WARNUNG

Achten Sie auf die Lautstärke! Hören mit zu hohem Lautstärkepegel kann Ihr Gehör dauerhaft schädigen.

Wartung

Ihr Gerät erfordert keine besondere Wartung. Wenden Sie sich jedoch im Falle einer Fehlfunktion an ein zugelassenes Servicecenter oder den Hersteller

Reinigung

Verwenden Sie zur Reinigung ein fusselreies und nur leicht feuchtes Tuch.

Technische Spezifikationen:

System: dynamische Kopfhörer

Nennimpedanz: 32 Ohm

Lautsprecher: Stereo

Frequenzbereich: 20-20000 Hz

Empfindlichkeit: 110dB SPL

WEEE-Erklärung

(Waste of Electrical and Electronic Equipment)

Ihr Produkt wurde unter Verwendung hochwertiger Materialien und Komponenten entwickelt und hergestellt, die recycelbar und wiederverwendbar sind. Das Symbol bedeutet, dass Ihr Produkt am Ende seiner Lebensdauer vom Hausmüll getrennt entsorgt werden muss.

Entsorgen Sie dieses Gerät bei Ihrer örtlichen Sammelstelle oder Recyclingstelle. Bitte helfen Sie mit, die Umwelt zu schützen, in der wir alle leben.

Alle technischen Daten und Erscheinungsbilder können ohne vorherige Ankündigung geändert werden. Alle Angaben waren zum Zeitpunkt der Drucklegung korrekt. Die Musikhaus Kirstein GmbH übernimmt keine Gewähr für die Richtigkeit oder Vollständigkeit der in diesem Handbuch enthaltenen Beschreibungen, Fotos oder Aussagen. Gedruckte Farben und Spezifikationen können geringfügig vom Produkt abweichen. Produkte der Musikhaus Kirstein GmbH werden nur über autorisierte Händler vertrieben. Distributoren und Händler sind keine Vertreter der Musikhaus Kirstein GmbH und nicht befugt, die Musikhaus Kirstein GmbH in irgendeiner Weise rechtlich zu binden.

Diese Bedienungsanleitung ist urheberrechtlich geschützt. Die Vervielfältigung dieser Bedienungsanleitung, auch auszugsweise, ist nur mit Genehmigung der Musikhaus Kirstein GmbH gestattet. Gleiches gilt für die Vervielfältigung oder das Kopieren von Bildern, auch in geänderter Form.

© 2024

 **KIRSTEIN.de**

Musikhaus Kirstein GmbH

Bernbeurener Str. 11

D-86956 Schongau

info@kirstein.de

www.kirstein.de

Telefon/Phone: +49(0)8861 / 90 94 94 -0



Classic Cantabile KH-238 Headphones HiFi dynamic

Item number: 00016331



User Manual

Version: 10.2024

Thank you for choosing this product.

To ensure that you are fully satisfied with the Classic Cantabile headphones, read this manual carefully and understand these instructions before using our product. Keep these operating instructions in a safe place. The operating instructions must be passed on to all subsequent users.



Please carefully follow the instructions!



WARNING

The signal word **WARNING** indicates the dangers that can lead to serious injuries without precautionary measures.

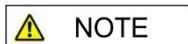

NOTE

The signal word **NOTE** indicates general precautionary measures that should be observed when handling the product.



NOTE

Images and screen shots in this manual may differ slightly from the appearance of the actual product as long as this has no negative effects on the technical properties and safety of the product.

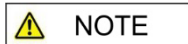

NOTE

All personal formulations in these operating instructions are to be considered gender-neutral.

These operating instructions apply to persons who have been supervised by a person responsible for their safety or who have been instructed in the operation of the device and have demonstrated that they can handle the device.



WARNING

Children should be supervised to ensure that they do not play with the device.

Do not leave children unattended. The product is not a toy!

All information in this operating manual has been checked to the best of our knowledge and belief. However, neither the author nor the publisher can be held liable for any damage associated with the use of this manual.

Other product, brand and company names mentioned in this document may be the trademarks of their respective owners. Compliance with all applicable copyright laws is the responsibility of the user of this document.

Detailed safety information:**⚠ NOTE**

- Read these instructions. Keep these instructions.
- Heed all warnings. Follow all instructions.
- Do not use this device near water.
- Only clean the device with a dry cloth.
- Do not block any ventilation openings.
- Do not place the device near heat sources such as radiators, stoves or other devices that generate heat.
- Pay attention to the volume! Hearing at a high-volume level can permanently damage your hearing.
- Contact qualified service personnel for all repair / maintenance work. Do not open the device or the housing yourself. Maintenance is required if the device has been damaged in any way, e.g., if the power cord or plug is damaged, liquid has been spilled or objects have fallen into the device, the device has been exposed to rain or moisture, is not working properly or has been dropped.

**Function:**

The headphones can be connected to every playing device (e.g., CD-players) as well as instrument (e.g., E-drumset, keyboard or piano). It is only important to note which jack plug is required for the used device: the 3.5 mm jack or the 6.3 mm jack of the adapter. (Adapter is included in delivery)

⚠ WARNING Pay attention to the volume! Hearing at a high-volume level can permanently damage your hearing.

Maintenance

Your device does not require any special maintenance. However, in the event of a malfunction, contact an approved service center or the manufacturer

Cleaning

Use a lint-free and only slightly damp cloth for cleaning.

Technical specifications:

System: dynamic headphones

Impedance: 32 Ohm

Speakers: Stereo

Frequency range: 20-20000 Hz

Sensitivity: 110dB SPL

WEEE declaration (Waste of Electrical and Electronic Equipment)

Your product has been developed and manufactured using high quality materials and components that are recyclable and reusable. The symbol means that your product must be disposed of separately from household waste at the end of its service life.

Dispose of this device at your local collection or recycling centre, please help protect the environment we all live in.

All technical data and appearances are subject to change without notice. All information was correct at the time of printing. Musikhaus Kirstein GmbH assumes no liability for the correctness or completeness of the descriptions, photos or statements contained in this manual. Printed colours and specifications may differ slightly from the product. Musikhaus Kirstein GmbH products are only sold through authorized dealers. Distributors and dealers are not representatives of Musikhaus Kirstein GmbH and are not authorized to bind Musikhaus Kirstein GmbH legally in any way.

This manual is protected by copyright. Reproduction of these operating instructions, in whole or in part, is only permitted with the approval of Musikhaus Kirstein GmbH. The same applies to the duplication or copying of images, even in modified form.

© 2024

 **KIRSTEIN.de**

Musikhaus Kirstein GmbH

Bernbeurener Str. 11

D-86956 Schongau

info@kirstein.de

www.kirstein.de

Phone: +49(0)8861 / 90 94 94 -0



STEINMAYER

P-60 Stagepiano

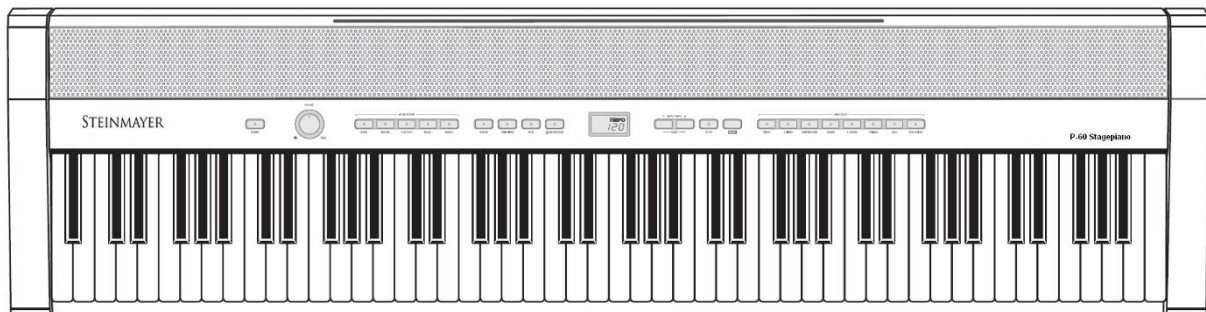

Bedienungsanleitung / Users manual

ArtNr 00055299, 00055300
Version 08/2018

Einleitung

Herzlichen Dank, dass Sie sich für das **Steinmayer P-60 Stagepiano** entschieden haben.

Wir wünschen Ihnen viel Spaß und Freude mit Ihrem neuen Steinmayer P-60 Stagepiano.

Bitte lesen Sie diese Anleitung aufmerksam, um die praktischen Funktionen des **Steinmayer P-60 Stagepianos** voll nutzen zu können.

Außerdem empfehlen wir Ihnen, dieses Handbuch an einem sicheren und leicht zugänglichen Ort aufzubewahren, um später darin nachschlagen zu können.

Achtung!

Vor dem ersten Einschalten und der Inbetriebnahme des Geräts lesen Sie auf Jeden Fall die Sicherheitsanweisungen durch um Verletzungen sowie Beschädigungen des Geräts zu vermeiden.

Bedienungsanleitung (deutsch) ab Seite 2

Introduction

Thank you for your purchase of the **Steinmayer P-60 Stage piano**.

We hope that you will enjoy the use of the Steinmayer P-60 Stage piano.

Please read through this manual carefully before beginning to use, so that you will be able to take full advantage of the **Steinmayer P-60 Stage piano** features and enjoy trouble-free operation for years to come.

Please keep this manual at a safe and dry place where you easily can access it.

Caution !

Before switching on the instrument or device read carefully the safety instructions to avoid serious injuries or damage of the product.

Operators manual (english) -> start from page 24

Inhaltsverzeichnis

Sicherheitsanweisungen	2	Main/Split/Layer Oktaveneinstellung	13
Aufbau Ihres Pianos	4	Stimmung	14
Bedienung und Steuerung	7	Transpose-Funktion	14
Kopfhöreranschluss	7	Reverb Lautstärke	14
Anschluss eines externen Geräts	7	Reverb Typ	14
Kontrolleinheit	8	Effektlautstärke	14
Standard Funktionen	9	Effekt Typ	14
Lautstärkeregelung	9	Equalizer	14
Auswahl der Stimme	9	Automatische Ausschaltung	14
Layer-Funktion	10	Lokale Midi Kontrolle	14
Split-Funktion	10	Zurücksetzung auf den Werkszustand	14
Veränderung des Split-Punktes	10	Aufnahme	15
Reverb-Funktion	11	Demo Musik	15
Nutzung des Metronoms	11	Klassische Demo Musik	15
Twin-Piano-Funktion	12	Klassische Demo Musikliste	16
Funktionen	12	Lern Demo Musik	17
Grundsätzliche Einstellung	13	Sonatine Demo Musik	18
Main/Split/Layer/Musiklautstärke	13	Schlagzeug- und Soundeffektabelle	19
Touch	13	MIDI Tabelle	20
		Problembehandlung	21
		Spezifikationen	22

Sicherheitsanweisungen

Bitte lesen Sie den folgenden Abschnitt sorgfältig durch, bevor Sie das Instrument in Gebrauch nehmen! Bitte bewahren Sie diese Bedienungsanleitung sorgfältig auf.

Stromversorgung

Bitte schließen Sie das mitgelieferte Netzteil an einer Steckdose mit korrekter Spannung an. Verbinden Sie das Gerät nicht mit einer Steckdose, deren Spannung für das Gerät nicht geeignet ist. Trennen Sie das Netzteil vom Strom, wenn Sie das Instrument nicht benutzen oder während eines Gewitters.

Anschlüsse

Bevor Sie das Instrument mit anderen Geräten verbinden, schalten Sie bitte alle Geräte zuerst aus. Das bewahrt die Geräte vor Schäden und hilft, Fehlfunktionen zu vermeiden.

Umgebung

Setzen Sie das Gerät den folgenden Bedingungen bitte nicht aus, um Verformungen, Verfärbungen oder ernsthaftere Schäden zu vermeiden:

- direktem Sonnenlicht
- extremen Temperaturen
- extremer Feuchtigkeit
- Staub oder Schmutz
- starken Vibrationen oder Erschütterungen - magnetischen Feldern.

Interferenzen

Sind Radio- oder Fernsehgeräte in der Nähe des Instruments aufgestellt, kann es zu Interferenzen kommen. Sollte, dass der Fall sein, stellen Sie die Geräte bitte weiter auseinander.

Reinigung

Bitte reinigen Sie das Instrument ausschließlich mit einem weichen, trockenen Tuch. Benutzen Sie bitte keine Farbverdünner, Lösungsmittel, Reinigungsflüssigkeiten oder chemisch imprägnierte Reinigungstücher.

Handhabung

Wenden Sie bitte keine übermäßige Gewalt beim Umgang mit Knöpfen und Schaltern an und sorgen Sie dafür, dass kein Papier, Metall oder sonstige Objekte in das Instrument gelangen können. Sollte es doch passieren, trennen Sie das Gerät bitte sofort vom Stromkreis und bringen Sie es zum Fachhändler zur Überprüfung.

Entfernen Sie bitte stets alle Kabelverbindungen, bevor Sie das Instrument bewegen!

Aufbau Ihres Stagepianos

Kartoninhalt

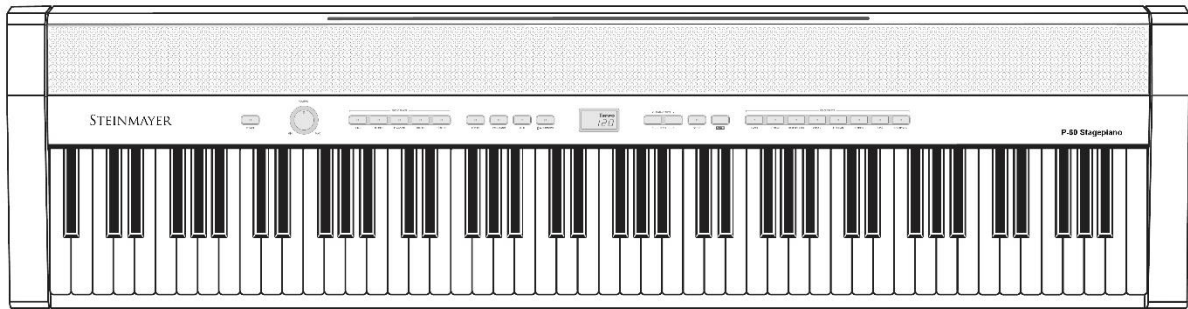

Stagepiano P-60

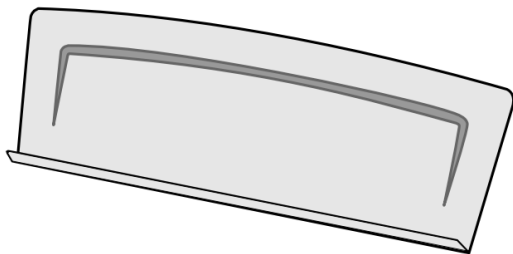

Notenhalter

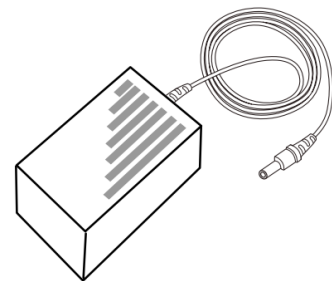

Netzteil

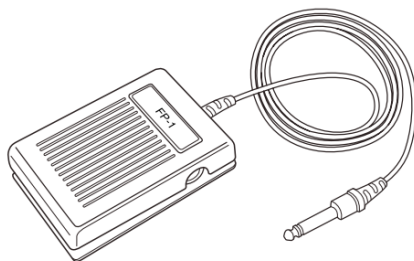

Pedal FP-1

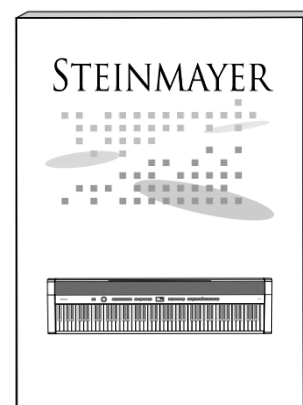

Bedienungsanleitung

Bevor Sie anfangen, das Instrument aufzubauen, vergewissern Sie sich, dass alle unten aufgeführten Teile im Paket enthalten sind. Falls eines der Teile beschädigt sein sollte wenden Sie sich bitte an unseren Kundendienst.

Aufbau Ihres Pianos

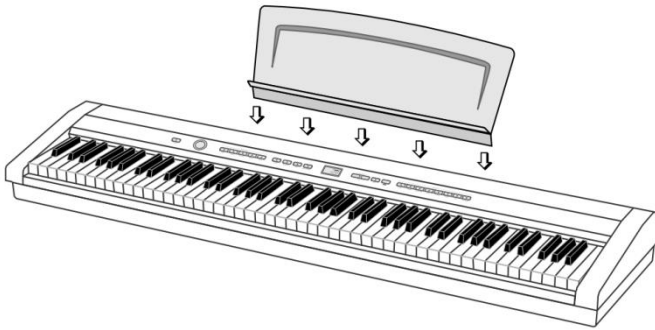

Stecken Sie den Notenhalter in die dafür vorgesehenen Ausschnitte.

Versorgung mit Strom

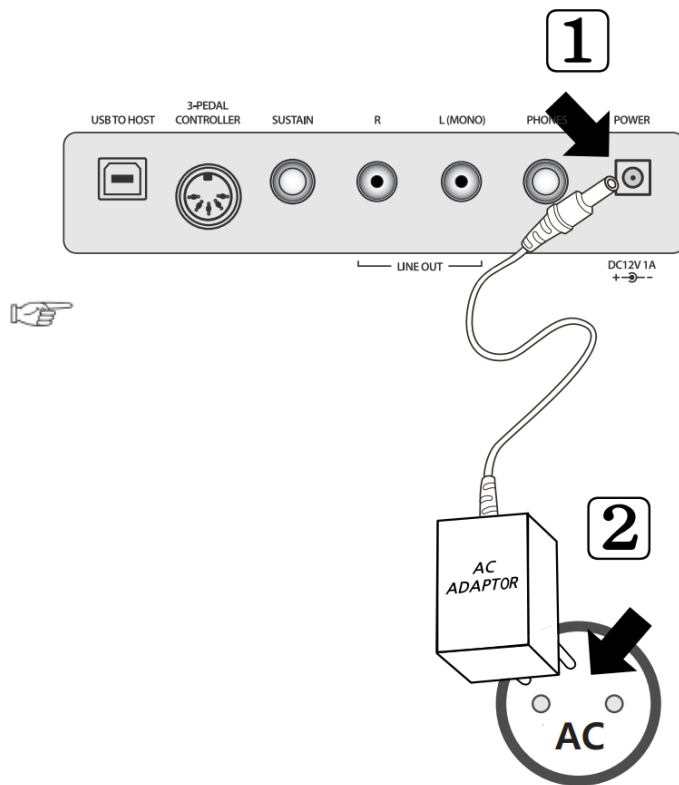

1. Stecken Sie das Netzteil in die Anschlussbuche am Piano und in Ihre Steckdose.

2. Schalten Sie das Piano mit Hilfe des POWER Knopfes an.

Nutzen Sie nur das mitgelieferte Netzteil, da es ansonsten zu Schäden aufgrund von Spannungsunterschieden kommen kann.

Benutzung des Fußpedals FP-1

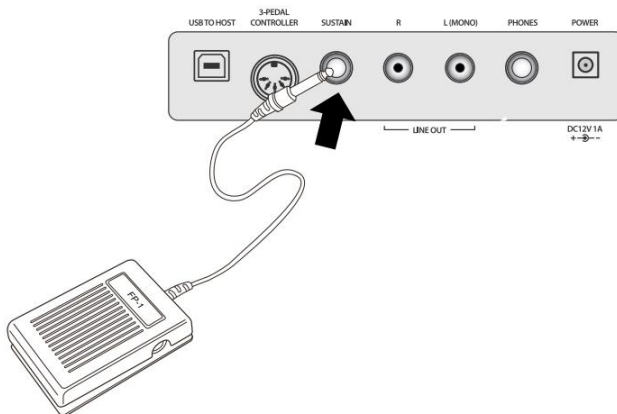

Die SUSTAIN Buchse wird für das mitgelieferte Fußpedal verwendet, welches wie ein Dämpfer an einem akustischem Piano funktioniert.

- Bitte benutzen Sie das Pedal nicht während dem Startvorgang, da dies sonst seine Polung ändert und dadurch umgekehrt funktioniert.
- Verbinden Sie das Pedal nur wenn Ihr Piano ausgeschaltet ist.

Verwendung der 3-Pedal Buchse

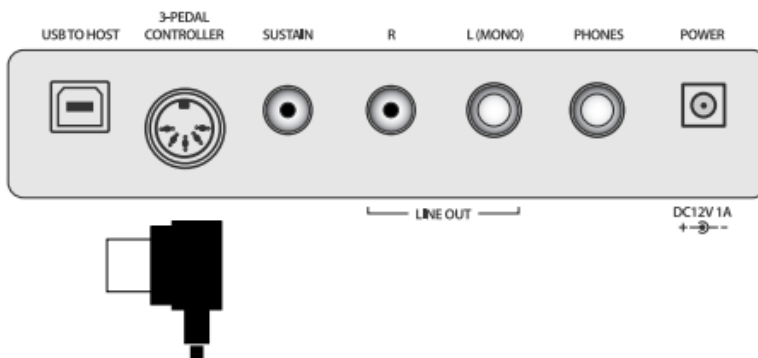

An dieser Buchse kann ein optional erhältlicher Controller mit drei Pedalen angeschlossen werden.

1. Sustain Pedal (rechtes Pedal)

Das Betätigen dieses Pedals lässt die Noten auch dann klingen, wenn Sie diese gar nicht mehr drücken.

2. Sostenuto Pedal (mittleres Pedal)

Wenn Sie auf das Sostenutopedal treten, während Sie Tasten gedrückt halten, werden die Töne so lange ausgehalten, wie Sie das Pedal loslassen. Die anschließend gespielten Töne werden nicht ausgehalten, sondern normal wiedergegeben. So können Sie beispielsweise einen Akkord mit Sustain versehen und andere Noten staccato spielen.

3. Soft Pedal (linkes Pedal)

Dieses Pedal reduziert die Lautstärke und ändert leicht das Timbre der gespielten Noten.

Bedienung und Steuerung

Kopfhöreranschluss

Hier kann ein Stereo Kopfhörer angeschlossen werden. Wenn diese Buchse verwendet wird, schalten sich die internen Lautsprecher automatisch ab.

Anschluss eines externen Geräts

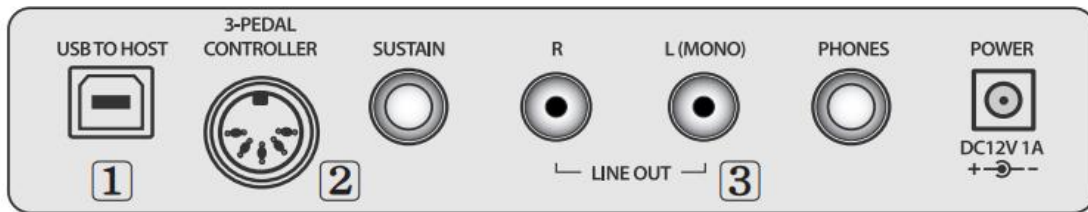

1. Mit einem Computer verbinden (via USB Terminal)

Das Stagepiano verfügt über einen USB Anschluss mit dem es direkt an einen PC angeschlossen werden kann und dadurch MIDI Signale austauschen kann.

1. Verbinden Sie das Piano mit dem Computer.
2. Um das Piano als MIDI Gerät nutzen zu können müssen Sie die MIDI Software auf Ihrem Computer starten und den input/output auf das USB Gerät festlegen.
3. Um das Piano als Audiogerät zu verwenden, verbinden Sie das Piano mit dem PC und stellen Sie anschließend das Audiogerät des Computers auf das Piano um.
2. An dieser Buchse kann ein optional erhältlicher Controller mit drei Pedalen angeschlossen werden.
3. Audio Output (AUX OUT)

Dieser Anschluss wird verwendet, wenn Sie eine stärkere externe Audioquelle anschließen wollen (z.B. Verstärker). Nutzen Sie ein Audiokabel und verbinden Sie es mit dem AUX OUT Anschluss des Pianos und dem „Input“-Anschluss des externen Gerätes.

Kontrolleinheit

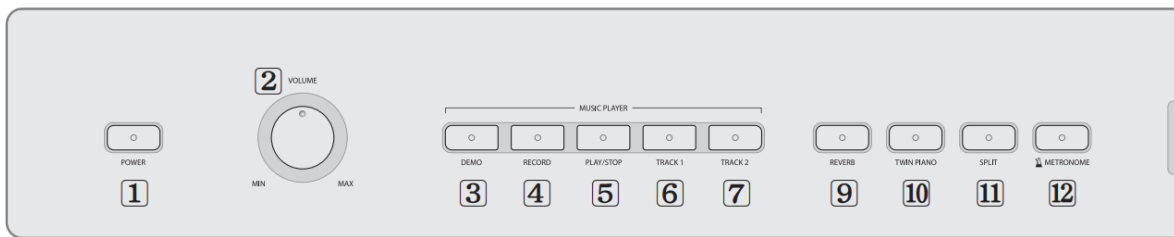

Stromversorgung

1. An-/Aus-Schalter

Lautstärke

2. Lautstärke

Aufnahme & Demo

3. Demo
4. Aufnahme
5. Play/Stop
6. Track 1
7. Track 2

Funktionen

8. Stimmen
9. Reverb
10. Twin Piano
11. Split
12. Metronom

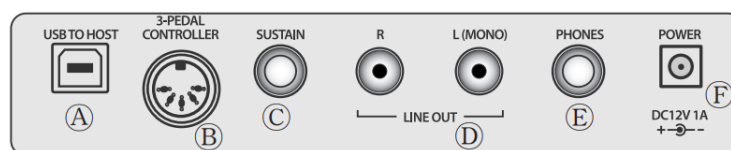
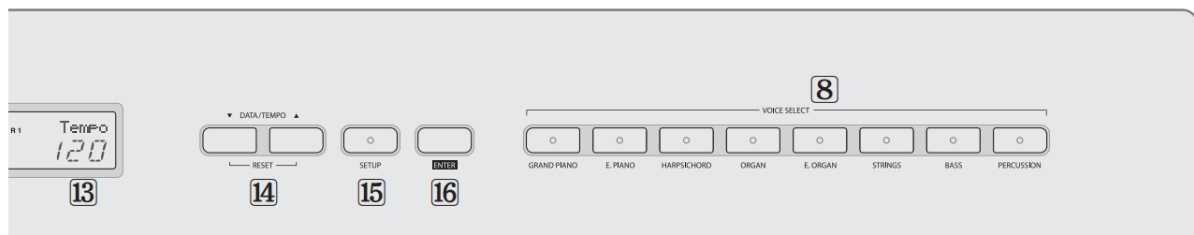

Einstellungen

13. LCD Monitor
14. DATA/Tempo
15. Setup
16. ENTER

Anschlüsse

- A) USB TO HOST
- B) 3-Pedal-Controller
- C) SUSTAIN
- D) LINE OUT R/L/MONO
- E) Kopfhörer
- F) Stromanschluss

Standard Funktionen

Anpassung der Lautstärke

Nutzen Sie den „Master Volume“ Regler um die Lautstärke anzupassen

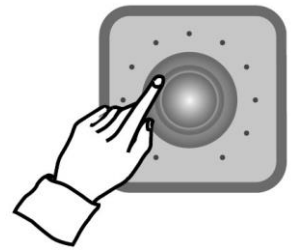

Auswahl der Stimme

Dieses Piano verfügt über die Fähigkeit, wie akustische, hochwertige Pianos/Flügel zu klingen und gleichzeitig wie andere Instrumente wie z.B. Schlagzeug zu klingen.

- 14 Sounds
- 1 Percussion Kit
- 1 Sound Effekt Set

Auswahl der gewünschten Stimme

Drücken Sie den Knopf, welcher die gewünschte Stimme beinhaltet.

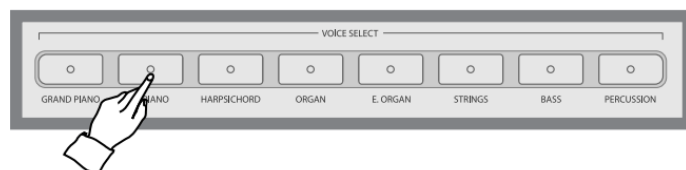
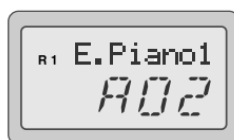

- Das Piano verfügt über 8 Stimmentasten welche jeweils mit zwei Stimmen belegt sind
- Nach der Auswahl wird die Stimme am Monitor angezeigt
- Um die zweite Stimme einer Stimmentaste zu wählen drücken Sie diese erneut

Liste der Stimmen

Grand Piano	E.Piano	Harpsichord	Organ	E.Organ	Strings	Bass	Percussion
Button 1	Button 2	Button 3	Button 4	Button 5	Button 6	Button 7	Button 8
G. Piano 1 G. Piano 2	E.Piano 1 E.Piano 2	Harpsichord Vibraphone	Organ 1 Organ 2	E. Organ 1 E. Organ 2	Strings 1 Strings 2	Acoust Bass Elec. Bass	Drum Set Sound FX

Layer-Funktion

Die Layer-Einstellungen ermöglicht es Ihnen ein breiteres Soundspektrum zu kreieren.

1. Drücken und halten sie Ihre Hauptstimm Taste und anschließend die zweite Stimme welche Sie über Ihre Hauptstimme legen wollen.

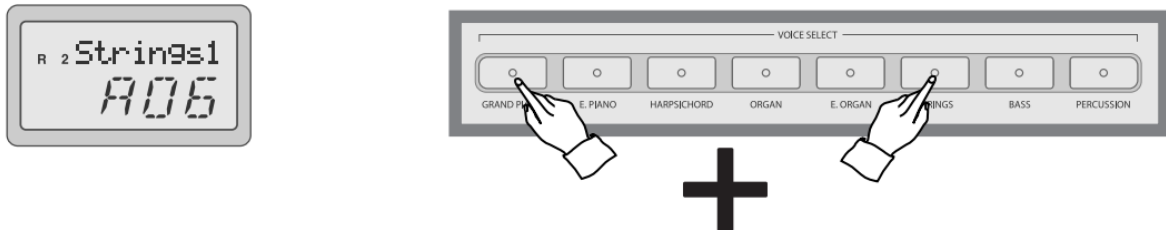

2. Drücken Sie eine beliebige Stimmentaste um die Funktion zu deaktivieren.

Split-Funktion

1. Auswahl einer Stimme (siehe Oben)
2. Um den Split-Modus zu aktivieren drücken Sie die SPLIT Taste und anschließend wird die LED aufleuchten.



3. Auswahl der Split-Stimme

Wählen Sie die gewünschte Stimme während die LED aufleuchtet.

Änderung des Split-Punktes

Sie können den Punkt an dem das Piano in den linken und rechten Teil aufgeteilt wird beliebig wählen indem Sie den SPLIT Knopf drücken und halten und gleichzeitig den gewünschten Split-Punkt wählen. Anschließend wird Ihre Auswahl am LCD Display angezeigt.

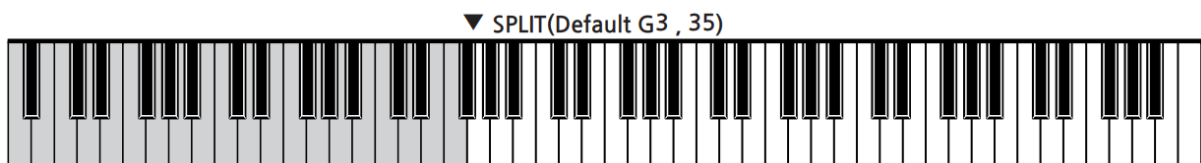

Reverb-Funktion

Bei dieser Funktion wird dem Sound ein Hall hinzugefügt, der das besondere Ambiente eines Konzertsaaes erahnen lässt.

Reverb Ein-/Ausschalten

Um die Funktion einzuschalten drücken Sie den REVERB Knopf. Die LED geht daraufhin an um anzuzeigen, dass die Funktion aktiviert ist. Um die Funktion auszuschalten drücken Sie den Knopf erneut.

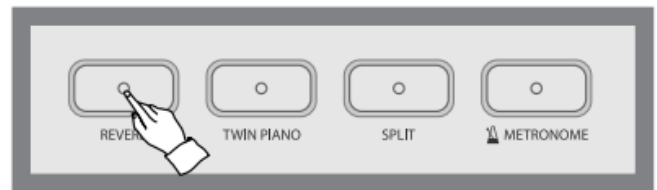

Nutzung des Metronoms

Starten/Stoppen des Metronoms

Drücken Sie hierzu den METRONOM Knopf.

Anpassung des Tempos

Das Metronom kann im Bereich zwischen 20 und 280 Schlägen pro Minute (BPM) eingestellt werden indem Sie die DATA/TEMPO Knöpfe verwenden.

- UP/DOWN halten für anhaltende Verlangsamung/Beschleunigung
- UP und DOWN gleichzeitig stellt das Standardtempo von 120 wieder her

Auswahl des Takts

Es steht Ihnen eine gewisse Auswahl an verschiedenen Beats zur Auswahl welche Sie verwenden können.

Drücken Sie hierzu den METRONOM Knopf für zwei Sekunden während das Metronom aktiviert ist. Nun sollte der LCD Monitor das derzeitige Metronom anzeigen. Nutzen Sie DATA UP / DOWN um das gewünschte Metronom auszuwählen.



- UP und DOWN gleichzeitig stellt das Standardmetronom her (1/4 Takt)
- **Metronom Takte: 1/4,2/4,3/4,4/4,5/4,6/8,9/8,C/8(12/8)**

Twin-Piano-Funktion

Diese Funktion teilt Ihr Piano in zwei kleinere Pianos mit identischer Oktavenreichweite um ein gemeinsames spielen zu ermöglichen.

1. Auswahl einer Stimme.
2. Drücken Sie den TWIN-PIANO Knopf.

Nun ist das Piano in zwei Bereiche aufgeteilt.

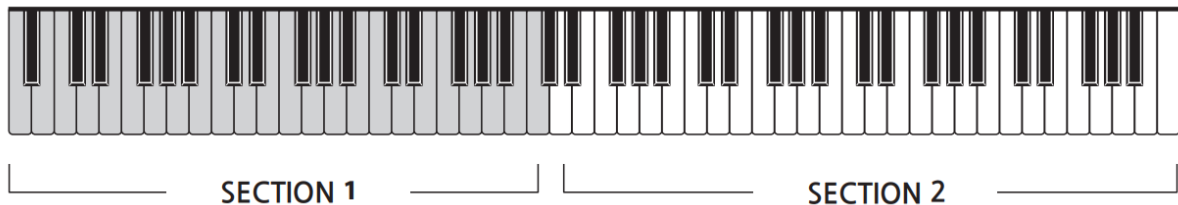

3. Um den Modus zu verlassen drücken Sie erneut den TWIN-PIANO Knopf.

Funktionen

Grundsätzliche Funktionen (Setup Modus)

1. **Aktivieren des Setup Modus.**
Drücken Sie hierzu den SETUP Knopf. Der LCD Monitor wird nun das Setup Menü anzeigen.
2. **Auswahl der gewünschten Funktion**
Nutzen Sie die DATA UP/DOWN Knöpfe um die gewünschte Funktion auszuwählen.
3. **Anpassung des Werts der ausgewählten Funktion**
Drücken Sie die ENTER Taste und ändern Sie den Wert mit DATA UP/DOWN.
 - Um den Setup-Modus zu verlassen drücken Sie die SETUP Taste.
 - DATA UP und DOWN gleichzeitig stellen die Werkseinstellungen wieder her.

Liste der Funktionen

DISPLAY	FUNCTION	DESCRIPTION	RANGE(DEFAULT)
Main Vol	Main Volume	Adjust the main voice volume	00 ~ 127(127)
SplitVol	Split Volume	Adjust the split voice volume	00 ~ 127(127)
LayerVol	Layer Volume	Adjust the layered voice volume	00 ~ 127(85)
MusicVol	Demo/Metronome Vol.	Adjust the music and the metronome volume	00 ~ 127(75)
Touch	Touch	Type of the Touch : OFF,SOFT,NORMAL,HARD	Off/SFT/NOR/HRD(NOR)
Main Oct	Main Octave	Set the main voice octave	-02 ~ 00 ~ +02(00)
SplitOct	Split Octave	Set the split voice octave	-02 ~ 00 ~ +02(00)
LayerOct	Layer Octave	Set the layered voice octave	-02 ~ 00 ~ +02(00)
Transpos	Key Transpose	Adjust the key transpose	-12 ~ 00 ~ +12(00)
Tune	Master Tune	Adjust the master tune	-64 ~ 00 ~ +63(00)
Rev. Vol	Reverb Volume	Adjust the reverb volume	00 ~ 127(45)
Rev. Type	Reverb Type	Set the reverb type 00(Off), 01(Room 1), 02(Room 2), 03(Room 3), 04(Hall 1), 05(Hall 2), 06(Plate), 07(Short Delay), 08(Long Delay)	00 ~ 08(03)
Eft. Vol	Effect Volume	Adjust the effect volume	00 ~ 127(80)
Eft. Type	Effect Type	Set the effect type 00(Off), 01(Chorus 1), 02(Chorus 2), 03(Chorus 3), 04(Chorus 4), 05(Chorus 5), 06(Delay 1), 07(Delay 2), 08(Delay 3)	00 ~ 08(00)
EQ. Bass	Bass EQ	Adjust Bass EQ	-12 ~ 00 ~ +12(06)
EQ. High	High EQ	Adjust High EQ	-12 ~ 00 ~ +12(01)
AutoPowr	Auto Power Off	Auto Power Off : ON/OFF	ON/OFF(ON)
L. Contrl	MIDI Local Control	MIDI Local control : ON/OFF	ON/OFF(ON)
Reset	Reset	Reset Piano	Enter to reset

Main/Split/Layer/Musiklautstärke

Alle Stimmen können hiermit individuell angepasst werden.

Touch

Diese Funktion bestimmt, in wie weit Ihre Anschlagskraft die Lautstärke des Sounds beeinflusst. Es stehen vier Einstellungsmöglichkeiten zur Verfügung, so dass Sie die Anschlagstärke der Art des Sounds, dem Song oder Ihren eigenen Vorlieben anpassen können.

Off: In dieser Einstellung klingen alle Töne gleich laut, egal wie fest oder zart Sie die Taste spielen.

Soft: Die Sounds klingen relativ laut, auch wenn Sie sanft spielen.

Normal: In dieser Einstellung klingt das Piano wie ein normales Klavier.

Hard: Sie müssen sehr kräftig spielen, um ein Maximum an Lautstärke zu erreichen.

Main/Split/Layer Oktaven

Mit dieser Funktion können Sie die verschiedenen Oktavenreichweite verändern.

Stimmung

Diese Einstellung erlaubt Ihnen die Feinstimmung Ihres Pianos. Wenn Sie z.B. mit anderen akustischen Instrumenten zusammenspielen die ein präzises Tuning benötigen.

Transpose-Funktion

Mit dieser Funktion können Sie die Tonhöhe des Pianos in Halbtonschritten verändern um sie an anderen Instrumenten oder Sängern anzupassen. Sie können so ganz einfach die Tonart wechseln ohne Ihren Fingersatz anpassen zu müssen. Wenn z.B. Transpose F gewählt ist, ertönt ein F, wenn Sie ein C spielen. In anderen Worten: Sie können das Stück in C-Dur spielen und hören es transponiert auf F-Dur.

- DATA UP und DOWN gleichzeitig stellen die Werkseinstellungen wieder her.

Reverb Lautstärke

Die Lautstärke kann angepasst werden.

Reverb Typ

Es gibt 8 verschiedene Arten der Reverb-Funktion

☞ 00(Off), 01(Chorus 1), 02(Chorus 2), 03(Chorus 3), 04(Chorus 4), 05(Chorus 5), 06(Delay 1), 07(Delay 2), 08(Delay 3)

Equalizer

Das Piano verfügt über einen 2 Band Equalizer welcher hier angepasst werden kann (Höhen und Tiefen).

Automatische Ausschaltung

Das Piano schaltet sich standardmäßig nach einer Inaktivität von 30 Minuten aus, um Energie zu sparen.

Nach dem Ausschalten der APO-Funktion wird das Piano nicht automatisch ausgeschaltet.

Lokale Midi Kontrolle

Local Control bezieht sich auf die Kontrolle, die die Klaviertastatur auf dem internen Soundsystem hat. Wenn Local Control auf ON gestellt ist, gehört das Soundsystem zur Klaviertastatur und das, was auf der Tastatur gespielt wird, wird über die Piano-Lautsprecher wiedergegeben.

Wenn Sie diese Funktion auf OFF schalten, können Sie die Verbindung zwischen der Tastatur und dem Soundsystem trennen. Wenn es ausgeschaltet ist, werden beim Spielen der Tastatur die Lautsprecher des Klaviers nicht aktiviert, um Töne zu erzeugen. Die Spieldaten werden weiterhin an jedes externe MIDI-Gerät übertragen, welches mit dem Piano verbunden ist. So können Sie das externe MIDI-Gerät mit der Klaviertastatur steuern, ohne, dass die internen Lautsprecher des Pianos erklingen.

Zurücksetzung auf den Werkszustand

Hiermit werden sämtliche Einstellungen zurückgesetzt und alle aufgenommenen Songs gelöscht.

- Wenn Sie im Reset-Menü die Enter-Taste drücken, beginnt das Piano zu resetten.
- Dieser Vorgang dauert ca. 5 Sekunden.
- Trennen Sie niemals die Stromversorgung während des Vorgangs.
- Nach dem Zurücksetzen zeigt das Display ‚TEMPO‘ an

Aufnahme

Mithilfe dieser Funktion können Sie eigene Songs aufnehmen und jederzeit abspielen. Das Piano verfügt über zwei Tracks und es können in einem Track ca. 9000 Noten gespeichert werden.

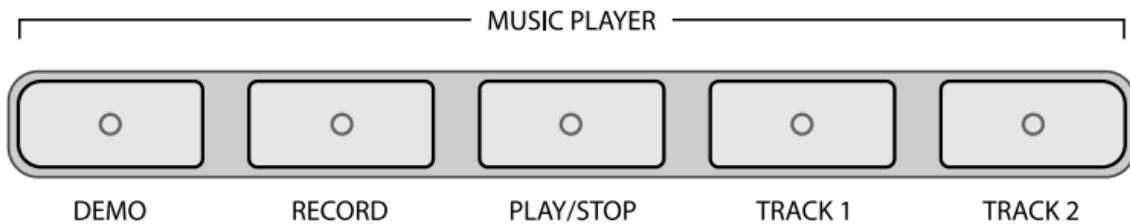

1. Vorbereitungen vor der Aufnahme

Wählen Sie die von Ihnen gewünschte Stimme und drücken Sie RECORD und TRACK 1 bzw. 2. Der Aufnahme Knopf leuchtet nun und der gewählte Track blinkt nun.

2. Aufnahme auf Track 1 bzw. 2

Spielen Sie nun Ihr Stück. Beide Knöpfe blinken nun.

3. Aufnahme stoppen

Drücken Sie TRACK 1 bzw. 2 oder den RECORD Knopf um die Aufnahme zu stoppen. Wenn Sie Ihr Lied nun hören möchten können Sie den PLAY/STOP Knopf nutzen.

- Um eine Aufnahme zu löschen drücken Sie entweder RECORD und PLAY/STOP gleichzeitig oder starten Sie einfach eine neue Aufnahme auf dem bereits beschriebenen Track.

Demo Musik

Klassische Demo Musik

Das Piano verfügt über 50 Demo Songs.

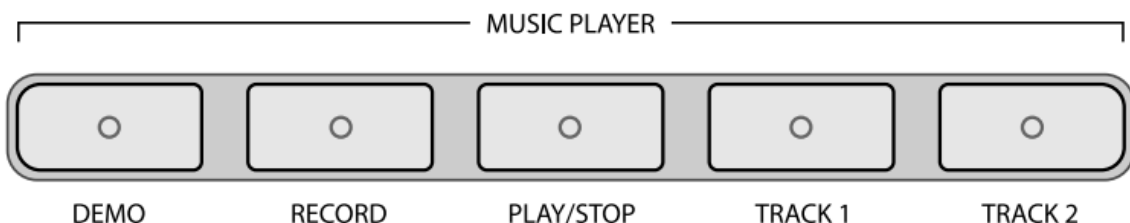

1. Demo Musik Modus starten

Drücken Sie den DEMO Knopf. Der Monitor zeigt nun „Classic“ an.

2. Abspielen eines Demo Songs

Drücken Sie ENTER und wählen Sie mithilfe der DATA UP/DOWN Knöpfe ihren Song aus und spielen diesen mit dem PLAY Knopf ab. Drücken Sie PLAY erneut um das Abspielen zu unterbrechen.

Liste der klassischen Demo Musik

DISPLAY	TITLE	COMPOSER
01	Etude op.10 no.1	Chopin, Fryderyk Franciszek
02	Etude op.10 no.4	
03	Etude op.10 no.5	
04	Etude op.25 no.9	
05	Nocturne op.9 no.1	
06	Nocturne op.9 no.2	
07	Nocturne op.27 no.2	
08	Nocturne op.32 no.1	
09	Nocturne op.72 no.1	
10	Sonata op.3 no.4	
11	Mazurka op.7 no.1	
12	Mazurka op.30 no.2	
13	Mazurka op.67 no.3	
14	Polonaise op.40 no.1	
15	Waltz op.34 no.1	
16	Waltz op.64 no.1	
17	Waltz op.64 no.2	
18	Waltz op.69 no.2	
19	Impromptu No. 4 c sharp minor(Fantasie-Impromptu) Op.66	
20	Ballade op.23 no.1 in g minor	
21	Ballade op.47 no.3 in A flat Major	
22	Prelude op.28 no.1 in C Major- Agitato	
23	Prelude op.28 no.16 in b-flat minor- Presto con fuoco	
24	Piano Sonata no.10 in C major, KV330 I. Allegro moderato	Mozart, Wolfgang Amadeus
25	Piano Sonata no.11 in A major, KV331 I. Alla turca : Allegretto	
26	Piano Sonata no.14 in c minor, KV457 I. Adagio	
27	Piano Sonata no.14 in c minor, KV457 III. Assai allegro	
28	Variations "Ah! Vous dirai-je, Maman"	
29	Rondo in D major, KV485	
30	Sonate no.8 in c minor, op.13 'Pathetique' Grave - Allegro molto e con brio	Beethoven, Ludwig van
31	Sonate no.8 in c minor, op.13 'Pathetique' II. Adagio cantabile	
32	Sonate no.8 in c minor, op.13 'Pathetique' III. Allegro	
33	Arabesque No.1 in E major	Debussy, Claude Achille
34	Suite bergamesque 1. Prelude	
35	Suite bergamesque 3. Clair de lune	
36	Petite Suite, for piano 4-hands 2. Cortege	
37	Scenes from Childhood op.15 From foreign lands and peoples in G major	Schumann, Robert Alexander
38	*12 Etudes d'execution transcendante(Transcendental Etudes), S 139 Etude Transcendante in d minor, Mazeppa	Liszt, Franz
39	The flight of the bumble bee(by S. Rachmaninov)	Rimsky, Korsakov
40	Trois Gymnopedies 1. Lent et douloureux	Satie, Erik
41	12 Fantasia per clavicembalo(TWV 33) - Harpsichord music - 1. Fantasia	Telemann, Georq Philipp
42	12 Fantasia per clavicembalo(TWV 33) - Harpsichord music - 3. Fantasia	
43	12 Fantasia per clavicembalo(TWV 33) - Harpsichord music - 5. Fantasia	
44	12 Fantasia per clavicembalo(TWV 33) - Harpsichord music - 6. Fantasia	
45	12 Fantasia per clavicembalo(TWV 33) - Harpsichord music - 12. Fantasia	
46	Children's Album, Op.39 No.4 Mama	Tchaikovsky, Pyotr Ilyich
47	Prelude in C major, BWV933	Bach, Johann Sebastian
48	Praludium und Fuge in B BWV560 -Pipe Organ music -	
49	Wohltemperiertes Klavier-Pledudio 1	
50	Wohltemperiertes Klavier-Fuga 1	

Lernmusik

Die Lernmusik ermöglicht es dem Benutzer, das Klavier mit einer Auswahl von eingebauten Klavierunterrichtsmusik zu üben.

Linke und rechte Hand können getrennt geübt werden, während das Tempo angepasst wird, um schwierige Passagen zu meistern.

1. Demo Musik Modus starten

Drücken Sie den DEMO Knopf. Der Monitor zeigt nun „Classic“ an. Dies ist die erste von sechs Musikgruppen welche Ihnen zur Verfügung stehen. Es gibt 5 Lernmusikgruppen und 1 klassische Musikgruppe in diesem Modus.

Display	Buyer	Czerny 100	Czerny 30	Czerny 40	Sonatine
Tune	106	100	30	40	45

2. Abspielen eines Demo Songs

Drücken Sie ENTER und wählen Sie mithilfe der DATA UP/DOWN Knöpfe ihren Song aus und spielen diesen mit dem PLAY Knopf ab. Drücken Sie PLAY erneut um das Abspielen zu unterbrechen.

Wählen Sie eine gewünschte Melodienummer in der ausgewählten Musikgruppe mit der DATA UP- oder DOWN-Tastengruppe.

- Wenn Sie vier Sekunden lang keine Musik auswählen, wird die erste Melodie automatisch eingestellt
- Wenn eine Melodie ausgewählt ist, leuchten die linke und die rechte Taste und Sie können die rechte oder die linke Hand durch Drücken der Taste 1 oder 2 stummschalten.

3. Wiedergabe der ausgewählten Musik

Drücken Sie die Wiedergabetaste (Play Taste). Die ausgewählte Musik beginnt zu spielen.

- Mit dieser Funktion können Sie den linken und rechten Teil der ausgewählten Übungsmelodie aktivieren oder deaktivieren und den Benutzer durch Drücken der linken und rechten Taste zum Üben jedes Teils veranlassen.
- Automatisches Starten des nächsten Titels nach dem Beenden der Wiedergabe.
- Die Lautstärke kann eingestellt werden (siehe Setup-Modus auf Seite 15, 16)
- Wenn Sie die Demo-Taste drücken, wechselt das Piano in den Performance-Modus.
- Wenn Sie die Daten auf (oder ab) Taste drücken, stoppt die Musik und die nächste (oder vorher) Melodie wird ausgewählt.

4. Musik stoppen

Drücken Sie PLAY um Playback zu stoppen.

5. Verlassen des Demo Modus

Drücken Sie den DEMO Knopf um dem Modus zu verlassen.

- Das Piano wechselt in den Performance-Modus.
- Um in den Musikauswahlmodus zu gelangen, drücken Sie die Eingabetaste im Demo-Modus.

Sonatine Demo Musik

DISPLAY	TITLE	COMPOSER
011	Sonatine op.20 no.1 1movement	F. Kuhlau
012	Sonatine op.20 no.1 2movement	
013	Sonatine op.20 no.1 3movement	
021	Sonatine op.20 no.2 1movement	
022	Sonatine op.20 no.2 2movement	
023	Sonatine op.20 no.2 3movement	
031	Sonatine op.20 no.3 1movement	
032	Sonatine op.20 no.3 2movement	
033	Sonatine op.20 no.3 3movement	
041	Sonatine op.55 no.1 1movement	
042	Sonatine op.55 no.1 2movement	
051	Sonatine op.55 no.2 1movement	
052	Sonatine op.55 no.2 2movement	
053	Sonatine op.55 no.2 3movement	
061	Sonatine op.55 no.3 1movement	M. Clementi
062	Sonatine op.55 no.3 2movement	
071	Sonatine op.36 no.1 1movement	
072	Sonatine op.36 no.1 2movement	
073	Sonatine op.36 no.1 3movement	
081	Sonatine op.36 no.2 1movement	
082	Sonatine op.36 no.2 2movement	
083	Sonatine op.36 no.2 3movement	
091	Sonatine op.36 no.3 1movement	
092	Sonatine op.36 no.3 2movement	
093	Sonatine op.36 no.3 3movement	
101	Sonatine op.36 no.4 1movement	
102	Sonatine op.36 no.4 2movement	
103	Sonatine op.36 no.4 3movement	
111	Sonatine op.36 no.5 1movement	
112	Sonatine op.36 no.5 2movement	
113	Sonatine op.36 no.5 3movement	
121	Sonatine op.36 no.5 1movement	J. Haydn
122	Sonatine op.36 no.5 2movement	
131	Sonatine Hob.16-35 1movement	
132	Sonatine Hob.16-35 2movement	W.A.Mozart
133	Sonatine Hob.16-35 3movement	
141	Sonatine K. 545 1movement	
142	Sonatine K. 545 2movement	L.V.Beethoven
143	Sonatine K. 545 3movement	
151	Sonatine op.49 no.2 1movement	
152	Sonatine op.49 no.2 2movement	J.L.Dusseck
161	Sonatine op.49 no.1 1movement	
162	Sonatine op.49 no.1 2movement	
171	Sonatine op.20 no.1 1movement	J.L.Dusseck
172	Sonatine op.20 no.1 2movement	

Schlagzeug- und Soundeffekttabelle

	Prog 1 Standard Drum	Prog 57 Sound FX
39 - D#2	High Q	Jing
40 - E2	Slap	Samul Drum 1
41 - F2	Scratch Push	Samul Drum 2
42 - F#2	Scratch Pull	Samul Cymbal 1
43 - G2	Sticks	Soft/Loud
44 - G#2	Square Click	Samul Cymbal 2
45 - A2	Metronome Click	Long/Short
46 - A#2	Metronome Bell	Samul Tong
47 - B2	Kick drum2/Jazz BD2	Low
48 - C2	Kick drum1/Jazz BD1	High
49 - C#3	Side Stick	Sogo
50 - D3	Snare Drum1	Good/Very Good
51 - D#3	Hand Clap	High Q
52 - E3	Snare Drum 2	Slap
53 - F3	Low Floor Tom	Scratch Push
54 - F#3	Closed Hi Hat [EXC1]	Scratch Pull
55 - G3	High Floor Tom	Sticks
56 - G#3	Pedal Hi-Hat [EXC1]	Square Click
57 - A3	Low Tom	Metronome Click
58 - A#3	Open Hi-Hat [EXC1]	Metronome Bell
59 - B3	Low-Mid Tom	Guitar Slide
60 - C4	Hi Mid Tom	Gt Cut Noise 1
61 - C#4	Crash Cymbal 1	Gt Cut Noise 2
62 - D4	High Tom	Double Bass Slap
63 - D#4	Ride Cymbal 1	Key Click
64 - E4	Chinese Cymbal	Laughing
65 - F4	Ride Bell	Screaming
66 - F#4	Tambourine	Punch
67 - G4	Splash Cymbal	Heart Beat
68 - G#4	Cowbell	Footsteps 1
69 - A4	Crash Cymbal2	Footsteps 2
70 - A#4	Vibraslap	Applause
71 - B4	Ride Cymbal2	Door Creaking
72 - C5	Hi Bongo	Door Closing
73 - C#5	Low Bongo	Scratch
74 - D5	Mute Hi Conga	Wind Chime
75 - D#5	Open Hi Conga	Car Engine Start
76 - E5	Low Conga	Car Breaking
77 - F5	High Timbale	Car Pass
78 - F#5	Low Timbale	Car Crash
79 - G5	High Timbale	Police Siren
80 - G#5	Low Agogo	Train
81 - A5	Cabasa	Jet Take-off
82 - A#5	Maracas	Helicopter
83 - B5	Short Whistle[EXC2]	Starship
84 - C6	Long Whistle[EXC2]	Gun Shot
85 - C#6	Short Guiro[EXC3]	Machinegun
86 - D6	Long Guiro[EXC3]	Lasergun
87 - D#6	Claves	Explosion
88 - E6	Hi Wood Block	Dog
89 - F6	Low Wood Block	Horse Gallop
90 - F#6	Mute Cuica[EXC4]	Birds
91 - G6	Open Cuica[EXC4]	Rain
92 - G#6	Mute Triangle[EXC5]	Thunder
93 - A6	Open Triangle[EXC5]	Wind
94 - A#6	Shaker	Sea Shore
95 - B6	Jingle Bell	Stream
96 - C7	Belltree	Bubble
97 - C#7	Castanets	Birds in Forest
98 - D7	Mute Surdo[EXC6]	Cricket
99 - D#7	Open Surdo[EXC6]	Bush Warbler
100 - E7		

MIDI-Tabelle

Function		Recognized	Transmitted	Remark
Basic Channel	Default	ALL	1-3	
Mode	Default	OMNI OFF, POLY	OMNI OFF, POLY	
Note ON/OFF	9nH kk w	O	O	#kk:note ON (0-127) #w:velocity (1-127)
Pitch Bender	EnH bi bh	O	O	Maximum swing +/- 1 tone
Control Change	00 BnH 00H cc	O	X	Bank Select
	01 BnH 01H cc	O	X	Modulation Wheel
	05 BnH 05H cc	O	X	Portamento Time
	06 BnH 06H cc	O	X	Data Entry
	07 BnH 07H cc	O	X	Volume
	10 BnH 0AH cc	O	X	Pan Out
	11 BnH 0BH cc	O	X	Expression
	64 BnH 40H cc	O	O	Sustain (Damper) Pedal
	65 BnH 41H cc	O	X	Portamento ON/OFF
	66 BnH 42H cc	O	O	Sostenuto Pedal
	67 BnH 43H cc	O	O	Soft Pedal
	80 BnH 80H w	O	X	Reverb Prog. (w=00H-70H)
	81 BnH 51H w	O	X	Chorus Prog.
	91 BnH 5BH w	O	O	Reverb Send Level
	93 BnH 5DH w	O	O	Chorus Send Level
	120 BnH 78H 00H	O	X	All Sound Off
121 BnH 79H 00H	O	X	Reset All Controller	
123 BnH 7BH 00H	O	X	All Notes Off	
126 BnH 7EH 00H	O	X	Mono On	
127 BnH 7FH 00H	O	X	Poly On	
Program Change	CnH PP	O	O	Sounds/Drum Set List
System Exclusive	General MIDI Reset	X	X	

O : Yes, X : No

Problembehandlung

Problem	Ursache	Lösung
Kein Sound	Problem mit der Stromversorgung	Überprüfen Sie das Stromkabel und seine Stecker.
	Lautstärke zu gering	Passen Sie die Lautstärke an.
	Kopfhörer sind angeschlossen.	Stecken Sie sie aus.
Gelegentliche Interferenzen	Kühlschrank, Waschmaschine oder ähnliche Geräte verursachen Interferenzen.	Stellen Sie das Piano so weit wie möglich von solchen Geräten weg.
Kein Sound bei Anschluss an externe Verstärker	Lautstärke zu niedrig eingestellt	Passen Sie die Lautstärke an.
	Defektes Kabel	Ersetzen Sie das Kabel.

Spezifikationen

Produkt	Steinmayer P-60 Stagepiano (00055299 schwarz; 00055300 weiß)
Tastatur	88 Tasten (Standard), 7 ¼ Oktaven
Anschlagempfindlichkeit	Aus, weich, normal, hart
Max. Polyphonie	128 Noten
Sounds	14 Sounds, 1 Drumkit, 1 Sound Effekt Set
Funktionen	Layer, Split, Twin Piano, Tune, Transpose, MIDI local, Pedal
Digitale Signalbearbeitung	8 Effekte, 8 Reverbs
Metronom	Ja
Display	LCD
Demo Musik	Klassische 50 Melodien 321 Lernmelodien: Buyer; Czerny 100, 30, 40; Sonatine
Aufnahme	Echtzeitaufnahme, 2 Spuren, ca. 18.000 Noten (9.000 Noten/Spur)
Lautstärkenregelung	Hauptsound, Layer, Split, Demo, Metronom, Low EQ Gain, Reverb, Effekt
Anschlüsse	USB IN, Pedal In, 3-Pedal Controller, Stereo Line Out, Kopfhörer
Lautsprecher	2 x 15W Stereo
Stromversorgung	DC IN 12V

WEEE-Erklärung / Entsorgung



Ihr Produkt wurde mit hochwertigen Materialien und Komponenten entworfen und hergestellt, die recycelbar sind und wiederverwendet werden können. Dieses Symbol bedeutet, dass elektrische und elektronische Geräte am Ende ihrer Nutzungsdauer vom Hausmüll getrennt entsorgt werden müssen. Bitte entsorgen Sie dieses Gerät bei Ihrer örtlichen kommunalen Sammelstelle oder im Recycling Center. Bitte helfen Sie mit, die Umwelt, in der wir leben, zu erhalten.

Technische Änderungen und Änderungen im Erscheinungsbild vorbehalten. Alle Angaben entsprechen dem Stand bei Drucklegung. Für die Richtigkeit und Vollständigkeit der enthaltenen Beschreibungen, Abbildungen und Angaben übernimmt Musikhaus Kirstein GmbH keinerlei Gewähr. Abgebildete Farben und Spezifikationen können geringfügig vom Produkt abweichen. Musikhaus Kirstein GmbH - Produkte sind nur über autorisierte Händler erhältlich. Distributoren und Händler sind keine Handlungsbevollmächtigten von Musikhaus Kirstein GmbH und haben keinerlei Befugnis, die Musikhaus Kirstein GmbH in irgendeiner Weise, sei es ausdrücklich oder durch schlüssiges Handeln, rechtlich zu binden. Diese Bedienungsanleitung ist urheberrechtlich geschützt. Jede Vervielfältigung, bzw. jeder Nachdruck, auch auszugsweise, und jede Wiedergabe der Abbildungen, auch in verändertem Zustand, ist nur mit schriftlicher Zustimmung der Firma Musikhaus Kirstein GmbH gestattet.

Herstellerangaben

Musikhaus Kirstein GmbH

Bernbeurener Strasse 11

86956 Schongau

Telefon: 0049-8861-909494-0

Telefax: 0049-8861-909494-19

www.kirstein.de

 **KIRSTEIN.de**

PRECAUTIONS

PLEASE READ CAREFULLY BEFORE PROCEEDING.

Please keep this manual in a safe and handy place for future reference.

For AC adaptor



WARNING

- This AC adaptor is designed for use with only the digital piano. Do not use for any other purpose.
- Indoor use only. Do not use in any wet environments.



CAUTION

- When setting up, make sure that the AC outlet is easily accessible. If some trouble or malfunction occurs, immediately turn off the power switch of the instrument and disconnect the AC adaptor from the outlet. When the AC adaptor is connected to the AC outlet, keep in mind that electricity is flowing at the minimum level, even if the power switch is turned off. When you are not using the instrument for a long time, make sure to unplug the power cord from the wall AC outlet.

For Piano



WARNING

Always follow the basic precautions listed below to avoid the possibility of serious injury or even death from electrical shock, short-circuiting, damages, fire or other hazards. These precautions include, but are not limited to, the following:

- Do not place the power cord near heat sources such as heaters or radiators. Also, do not excessively bend or otherwise damage the cord, or place heavy objects on it.
- Only use the voltage specified as correct for the instrument. The required voltage is printed on the name plate of the instrument.
- Use the specified adaptor (page 5) only. Using the wrong adaptor can result in damage to the instrument or overheating.
- Check the electric plug periodically and remove any dirt or dust which may have accumulated on it.
- This instrument contains no user-serviceable parts. Do not open the instrument or attempt to disassemble or modify the internal components in any way. If it should appear to be malfunctioning, discontinue use immediately and have it inspected by qualified service personnel.
- Do not expose the instrument to rain, use it near water or in damp or wet conditions, or place on it any containers (such as vases, bottles or glasses) containing liquids which might spill into any openings. If any liquid such as water seeps into the instrument, turn off the power immediately and unplug the power cord from the AC outlet. Then have the instrument inspected by qualified service personnel.
- Never insert or remove an electric plug with wet hands.
- Do not put burning items, such as candles, on the unit. A burning item may fall over and cause a fire.
- When one of the following problems occur, immediately turn off the power switch and disconnect the electric plug from the outlet. Then have the device inspected by service personnel.
 - The power cord or plug becomes frayed or damaged.
 - It emits unusual smells or smoke.
 - Some object has been dropped into the instrument.
 - There is a sudden loss of sound during use of the instrument.



CAUTION

Always follow the basic precautions listed below to avoid the possibility of physical injury to you or others, or damage to the instrument or other property. These precautions include, but are not limited to, the following:

- Do not connect the instrument to an electrical outlet using a multiple-connector. Doing so can result in lower sound quality, or possibly cause overheating in the outlet.
- When removing the electric plug from the instrument or an outlet, always hold the plug itself and not the cord. Pulling by the cord can damage it.
- Remove the electric plug from the outlet when the instrument is not to be used for extended periods of time, or during electrical storms.
- Do not place the instrument in an unstable position where it might accidentally fall over.
- Before moving the instrument, remove all connected cables, to prevent damage to the cables or injury to anyone who might trip over them.
- When setting up the product, make sure that the AC outlet you are using is easily accessible. If some trouble or malfunction occurs, immediately turn off the power switch and disconnect the plug from the outlet. Even when the power switch is turned off, electricity is still flowing to the product at the minimum level. When you are not using the product for a long time, make sure to unplug the power cord from the wall AC outlet.
- Use only the stand specified for the instrument. When attaching it, use the provided screws only. Failure to do so could cause damage to the internal components or result in the instrument falling over.
- Before connecting the instrument to other electronic components, turn off the power for all components. Before turning the power on or off for all components, set all volume levels to minimum.
- Be sure to set the volumes of all components at their minimum levels and gradually raise the volume controls while playing the instrument to set the desired listening level.
- Do not insert a finger or hand in any gaps on the instrument.
- Never insert or drop paper, metallic, or other objects into the gaps on the panel or keyboard. This could cause physical injury to you or others, damage to the instrument or other property, or operational failure.
- Do not rest your weight on, or place heavy objects on the instrument, and do not use excessive force on the buttons, switches or connectors.
- Do not use the instrument/device or headphones for a long period of time at a high or uncomfortable volume level, since this can cause permanent hearing loss. If you experience any hearing loss or ringing in the ears, consult a physician.

- ☒ Always turn the power off when the instrument is not in use.
- ☒ Even when the [POWER] switch is in standby status (power lamp is off), electricity is still flowing to the instrument at the minimum level. When you are not using the instrument for a long time, make sure you unplug the power cord from the wall AC outlet.

NOTICE

To avoid the possibility of malfunction/ damage to the product, damage to data, or damage to other property, follow the notices below.

- Do not use the instrument in the vicinity of a TV, radio, stereo equipment, mobile phone, or other electric devices. Otherwise, the instrument, TV, or radio may generate noise. When you use the instrument along with an application on your iPad, iPhone or iPod touch, we recommend that you set " Airplane Mode" to " ON" on that device in order to avoid noise caused by communication.
- Do not expose the instrument to excessive dust or vibrations, or extreme cold or heat (such as in direct sunlight, near a heater, or in a car during the day) to prevent the possibility of panel disfiguration, damage to the internal components or unstable operation. (Verified operating temperature range: 5° – 40° C, or 41° – 104° F.)
- Do not place vinyl, plastic or rubber objects on the instrument, since this might discolor the panel or keyboard.
- When cleaning the instrument, use a soft cloth. Do not use paint thinners, alcohol, solvents, cleaning fluids, or chemical-impregnated wiping cloths.
- Some types of data will be stored in internal memory, and maintained even if the power is turned off. However, the data could be lost due to malfunction or incorrect operation. Save important data to a computer.



Welcome

Thank you and congratulations on your purchase of the digital piano.

Your new digital piano is a state-of-the-art musical instrument which incorporates the latest electronics technology to make its operation as easy as possible.

In addition to the many features usually found on digital pianos, this contains a variety of educational resources that can be used for the learning of musical concepts and piano skills.

Your versatile digital piano is ideal for both beginners and experienced musicians alike.

The piano's compact size will allow it to fit into many places where a traditional or large-sized digital piano can't.

Its slim stylish design will match most home interiors.

In order to enjoy and utilize the features and functions of this unit to their fullest, be sure to carefully read this manual and follow the instructions contained herein.

Table of Contents

PRECAUTIONS	1	Main/ Split/ Layer/ Music Volume	16
For AC adaptor	1	Touch	16
For Piano	1	Main/ Split/ Layer Octave	16
Welcome	3	Tune	16
Table of Contents	3	Transpose	16
		Reverb Volume	17
Unpacking	4	Reverb Type	17
Setting Up Your Piano	5	Effect Volume	17
		Effect Type	17
Controls and Terminals	7	EQ	17
Turning ON the Power	7	Auto Power Off	17
Headphone	7	MIDI Local Control	17
Connecting to the External Device	8	Reset	17
Control Panel	9		
Basic Operation	11	Recording	18
Adjusting the Volume	11	Recording and Playback	18
Selecting Voices	11	Demo Music	19
Layer	12	Classic Demo Music	19
Split	12	Classic Demo Music List	20
Changing the Split Point	13	Educational Demo Music	21
Reverb	13	Sonatine Demo Music List	22
Using the Metronome	14	Drum and SFX Table	23
Twin Piano	14	MIDI Implementation Chart	24
Function	15	Troubleshooting	25
Setup mode	15	Specifications	26



Unpacking

Carefully take out the digital piano and its accessories from the packing box.
The digital piano set consists of the following items.

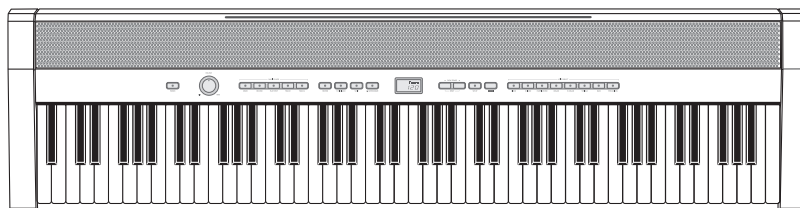

Digital Piano

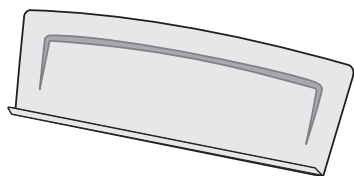

Music Rest

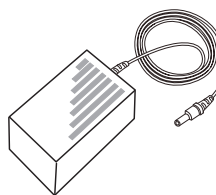

AC Adaptor

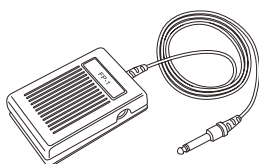

Pedal FP-1

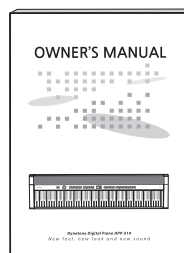

Owner's Manual

- ☒ Inspect each item carefully to make sure that it is in a good condition. If you find any item missing or damaged, immediately contact the place of purchase for replacement

Setting Up Your Piano

Music Rest

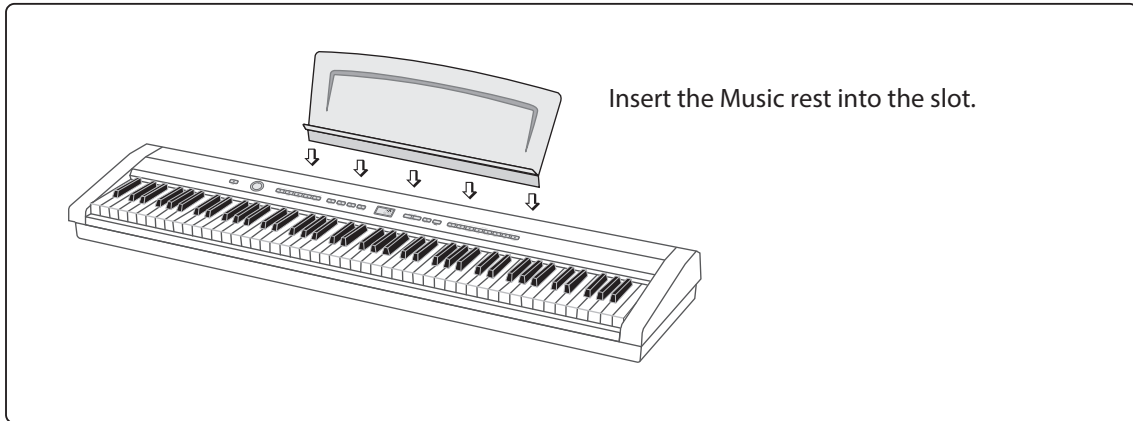

Power Requirements

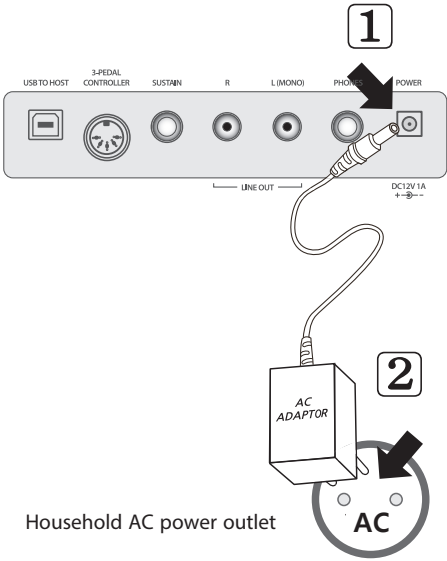

1 Connect the AC POWER ADAPTOR. Insert the DC plug of the AC adaptor into the piano and the AC plug into a household AC power outlet.

2 Turn on POWER by pressing the POWER button.

- ☒ Use the specified adaptor only. Using the wrong adaptor can result in damage to the instrument or overheating.
- ☒ When setting up the product, make sure that the AC outlet you are using is easily accessible. If some trouble or malfunction occurs, immediately turn off the power switch and disconnect the plug from the outlet.

Household AC power outlet

USING BATTERY
This Piano can be powered by batteries instead of the AC power adaptor.

- ☒ D size 6 batteries required. The battery life is approximate 4 hours.
- ☒ Always make sure you turn the piano off whenever your not using.

Using the Foot Pedal (FP-1)

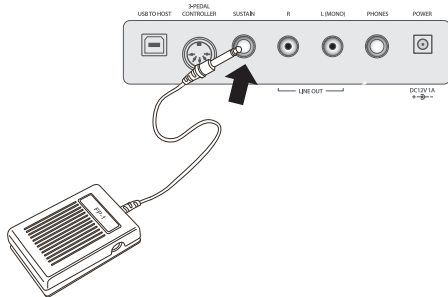

The SUSTAIN jack is for connecting the included foot pedal FP-1, which works in the same way as a damper pedal on an acoustic piano.

- Do not press the footswitch when turning the power on. Doing this changes the recognized polarity of the footswitch, resulting in reversed footswitch operation.
- Make sure that power is OFF when connecting or disconnecting the footswitch or pedal.

Using the Optional 3-Pedal Controller

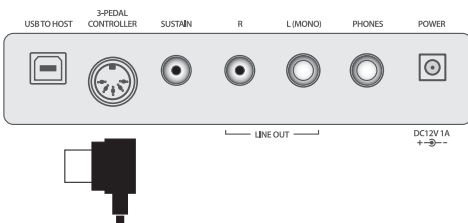

The 3-PEDAL CONTROLLER jack is for connecting an optional 3-pedal controller. When connecting the pedal unit, make sure to also assemble the unit on an optional keyboard stand.

- ☑ RIGHT PEDAL (Damper Pedal)
When the voice is set to any of the piano variants, the right pedal performs the same role as the damper pedal of acoustic pianos. With organ voices, the pedal causes notes to be sustained indefinitely until its release.
- ☑ CENTER PEDAL (Sostenuto Pedal)
The sostenuto pedal, like the damper pedal, causes the affected notes to be sustained until the release of the pedal, but only the notes that are being played at the moment the pedal is depressed are affected. All subsequent notes played while the pedal is being held down are not affected.
- ☑ LEFT PEDAL (Soft Pedal)
Depressing the pedal softens the sound of the notes being played.

Controls and Terminals

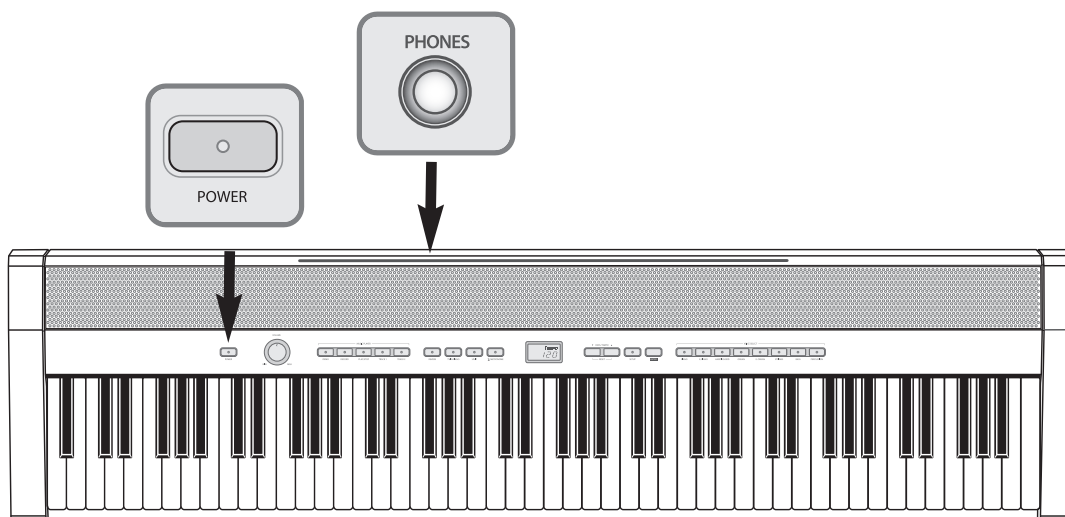

Turning ON the Power

1 Connect the AC POWER ADAPTER.

Insert the DC plug of the AC adapter into the piano and the AC plug into a household AC power outlet.

- See ' Power requirements ' on page 5.

2 Turn on POWER

Press the POWER button to turn on the piano. The LCD screen will show the initial screen.

- The voice is initially set to Grand Piano.
- Adjust the volume by using MASTER VOLUME .
- Auto Power Off

Following 30 minutes of inactivity, the piano will be turned off automatically to preserve energy.

To disable the auto power-off system, turn off the APO option on the setup menu, see Setup mode on page 15.

3 Turn off POWER

Press the POWER button. All lights and the LCD screen will be turned off.

- Backing Up the recorded song

The recorded music will be preserved even if the power is turned off and then on again.

Headphone

Connect a set of stereo headphones(optional) to the PHONES jack(standard 1/4").

Insert the headphone plug into the PHONES jack on the back of the main unit.

When headphones are connected, the internal speaker system is automatically shut off.

Connecting to the External Devices

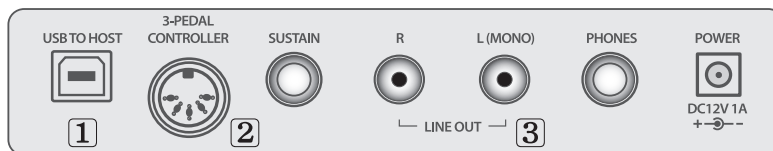

Terminals

① USB to HOST(Connecting to a Computer)

By connecting a computer to the USB, you can transfer MIDI and audio data between the instrument and the computer and take advantage of sophisticated computer music programs.

When connecting to a computer, the digital piano can be used as an audio device of your computer.

When you connect the digital piano to a computer, the device driver required to send and receive data will be installed on the computer.

The below instructions explain how to connect and use the terminals.

☒ CAUTION - Precautions when using the USB terminal.

When connecting the computer to the USB terminal, make sure to observe the following points. Failing to do so risks freezing the computer and corrupting or losing data. If the computer or the instrument freezes, turn the power of the instrument off and restart the computer.

② 3-Pedal controller(Connecting to the optional 3-Pedal)

The 3-PEDAL CONTROLLER jack is for connecting an optional 3-pedal controller. When connecting the pedal unit, make sure to also assemble the unit on an optional keyboard stand.

③ Line Out(Connecting to an External AMP)

Connect the instrument's LINE OUT jack and the input jacks of a pair of powered speakers using appropriate stereo audio cable.

Control Panel

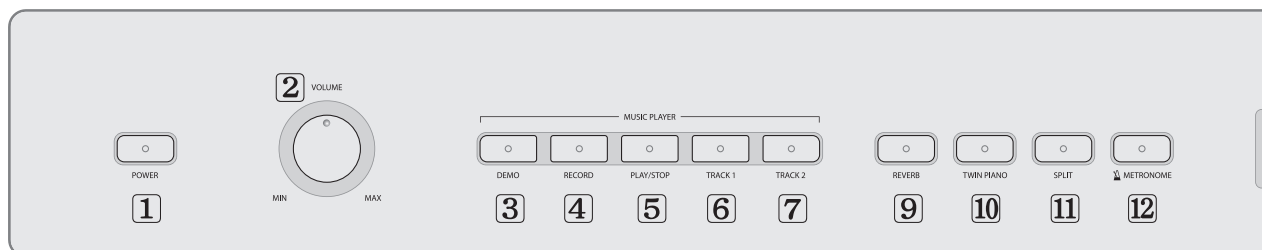

POWER

1 POWER Switch Page 7

VOLUME

2 MASTER VOLUME Page 11

RECORD & DEMO

- 3 DEMO Page 19,21
- 4 RECORD Page 19
- 5 PLAY/STOP Page 18,19,21
- 6 TRACK1 Page 18,21
- 7 TRACK2 Page 18,21

PERFORMANCE

- 8 VOICE Buttons Page 11
- 9 REVERB Page 13
- 10 TWIN PIANO Page 14
- 11 SPLIT Page 12
- 12 METRONOME Page 14

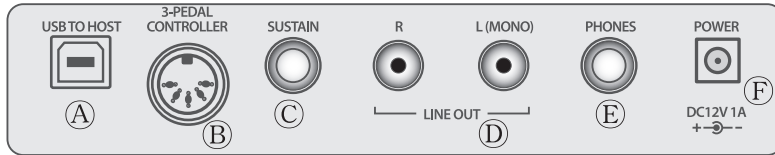
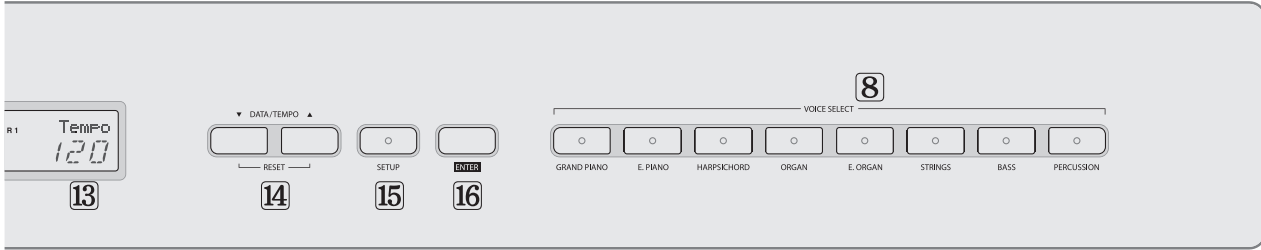

SETUP

- 13 LCD screen
- 14 DATA/TEMPO
- 15 SETUP Page 15
- 16 ENTER Page 15

TERMINALS

- A USB TO HOST Page 8
- B 3-PEDAL CONTROLLER Page 6,8
- C SUSTAIN Page 6
- D LINE OUT R,L/MONO Page 8
- E PHONES Page 7
- F DC IN Page 5

Basic Operation

Adjusting the Volume

The piano has one volume knob on the panel for adjusting the volume.

MASTER VOLUME

This determines the entire volume of the piano.

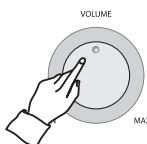

- This also determines the volume level of the HEADPHONE(s) .

Selecting Voices

The piano features a wealth of rich, authentic voices, including piano, organ, elec. piano, strings and other instruments. It also features a keyboard percussion function that lets you play realistic drum, percussion sounds, and various effect sounds directly from the keyboard.

- Voice Types
- 14 Sounds
 - 1 Drum kit
 - 1 Sound Effect set

1 Select a Voice.

Select the desired voice by pressing the appropriate VOICE button.

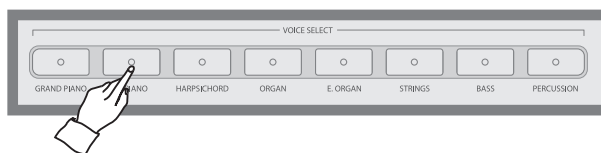
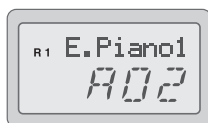

- The digital piano has 8 voice buttons and each voice button has two assigned voices.
- When a voice button is pressed, the assigned voice will be shown on the display.
- To select the other voice assigned to the current button, press the button again.

Voice List

Grand Piano	E.Piano	Harpichord	Organ	E.Organ	Strings	Bass	Percussion
Button 1	Button 2	Button 3	Button 4	Button 5	Button 6	Button 7	Button 8
G. Piano 1 G. Piano 2	E.Piano 1 E.Piano 2	Harpichord Vibraphone	Organ 1 Organ 2	E. Organ 1 E. Organ 2	Strings 1 Strings 2	Acoust Bass Elec. Bass	Drum Set Sound FX

2 Play the selected voice.

Adjust the volume by using **MASTER VOLUME** and play the piano with the selected voice.

Layer

The Layer mode of the piano allows you to select and play two different voices simultaneously in a layer. This makes it easy to create exceptionally rich and thick tonal textures. The volume balance can be set individually for each of the two voices.

1 Press and hold down the button corresponding to your desired main voice, then press the button of your desired layer voice.

Select a voice in the normal way. (See the **SELECTING VOICE** section on page 11.)

- With the Layer mode active, playing keys will result in both main and layered voice sounding.
- Volume of the layered voice can be adjusted independently in the setup mode. (See the **SETUP** section on page 15,16.)

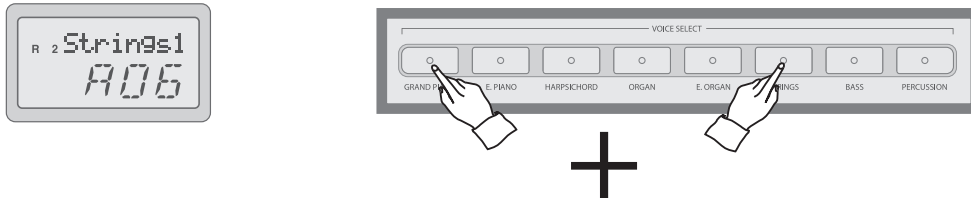

2 Press a voice button to deactivate the layer.

Split

The split mode allows you to assign different voices of each of the left and right parts of the keyboard. For example, you may play the bass on the left while still playing in piano voice on the right.

PLAYING WITH SPLIT VOICE

1 Select a main voice.

Select a voice in the normal way. (See the **SELECTING VOICE** section on page 11.)

2 Call up the Split mode.

To call up the split mode, press the **SPLIT** button. The lamp will begin flashing; the LCD screen will display the number of current split voice.

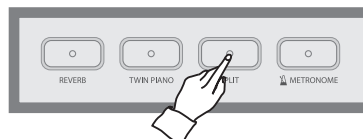

- ☑ The default voice is 'A 07' ACOUSTIC BASS in the split mode.

3 Select the split voice.

Select the voice while the split button is flashing.

- ☑ Volume of the split voice can be adjusted independently in the setup mode. (See the **SETUP** section on page 16.)

Changing the Split Point

You can set the point dividing the right and left parts of the keyboard at any desired key position.

Hold down the **SPLIT** button and press the desired key to assign it as the new split point. The LCD screen will display the corresponding number of the chosen key.

- ☑ SPLIT(Default G 3 , 35)



- ☑ Key number of the lowest note is '01'.

Reverb

Reverb is an effect that recreates the decaying reflections of a sound in a performance space, and reproduces the special ambience of a concert hall.

REVERB ON/OFF

To turn on the reverb, press the **REVERB** button. The lamp will be lighted to indicate that the reverb is now active.



To turn off the reverb, press the **REVERB** button again. The lamp will be off, indicating that the reverb is no more active.

- ☑ Reverb is set ON by default.
- ☑ The type and volume of reverb may be adjusted in the setup mode.(See the **SETUP** section on page 15,17.)

Using the Metronome

The piano features a convenient metronome that is ideal for practice.

START/STOP THE METRONOME

To start the metronome, simply press the **METRONOME** button. Press the **METRONOME** button again to stop the metronome sound.

ADJUSTING THE TEMPO OF THE METRONOME

You can set the tempo to a range of 20 ~ 280 beats per minute by using the **DATA/TEMPO** buttons.

- ☒ Hold the button for continuous decrementing or incrementing.
- ☒ Pressing the **UP** and **DOWN** buttons simultaneously will instantly restore the default tempo(120).
- ☒ Metronome volume can be adjusted in the setup mode.(See the **SETUP** section on page 19.)

SELECTING THE BEAT

The metronome may be set for a specific meter, causing it to make a distinguished beep sound to indicate every first beat of each measure.

Press and hold the **METRONOME** button for 2 seconds while the metronome is active. The LCD screen will display the current meter of the metronome. Use **DATA UP** or **DOWN** button to set the metronome to your desired meter.

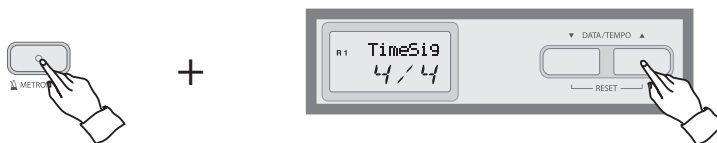

- ☒ Pressing both **DATA UP** and **DOWN** buttons simultaneously will instantly restore the default metronome meter(1/4).
- ☒ **METRONOME BEAT :** 1/4, 2/4, 3/4, 4/4, 5/4, 6/8, 9/8, C/ 8(12/8)

Twin Piano

The twin piano is a tool that divides the piano into two smaller pianos with identical octave range. This feature allows two people to play the piano in the same octave range simultaneously.

1 Select a Voice.

Select a voice in the normal way.(See the **SELECTING VOICE** section on page 13.)

2 Press the TWIN PIANO button.

The keyboard is split into two sections with identical octave range.

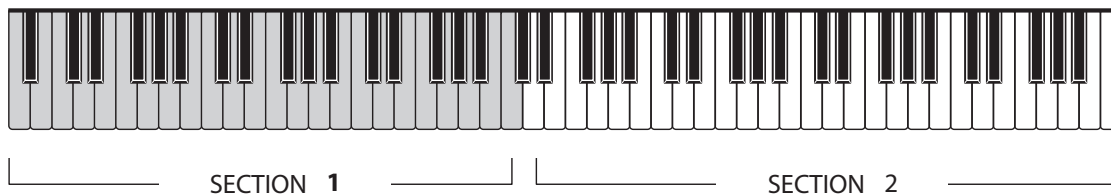

3 Press the TWIN PIANO button again to deactivate the twin piano.

The lamp will be off, indicating that the twin piano is no more active.

Function

The set values for each of the 19 functions can be adjusted in the setup menu. The setup menu also gives you the option of re-initializing the piano, restoring the values of all functions to their default and bringing the piano to its initial status.

Setup mode

1 Call up the setup mode.

Press **SETUP** button to call up setup mode. The LCD screen will show the first setup menu 'Main Volume or the latest operated setup menu.

2 Select a desired function.

Select a desired function by using the **DATA UP** or **DOWN** button.

- The LCD screen will display the current value of the selected function.

3 Adjust the value of the selected function.

Press the **ENTER** button and adjust the value by using the **DATA UP** or **DOWN** button.

Refer to the below function list.

- The value can be adjusted during flashing the value display.
- To exit setup mode, press the **SETUP** button.
- To go to the function selection menu, press the **ENTER** button on the adjustment value menu.
- Pressing both **DATA UP** and **DOWN** buttons simultaneously will instantly restore the default value of the selected function.
- If the **ENTER** button on the **RESET** menu is pressed, all memories and functions of the piano will be initialized.
- Backing Up adjusted value The lasted values of the functions will be retained in memory until turns off the power.

FUNCTION LIST

DISPLAY	FUNCTION	DESCRIPTION	RANGE(DEFAULT)
Main Vol	Main Volume	Adjust the main voice volume	00 ~ 127 (127)
SplitVol	Split Volume	Adjust the split voice volume	00 ~ 127 (127)
LayerVol	Layer Volume	Adjust the layered voice volume	00 ~ 127 (85)
MusicVol	Demo/Metronome Vol.	Adjust the music and the metronome volume	00 ~ 127 (75)
Touch	Touch	Type of the Touch : OFF,SOFT,NORMAL,HARD	Off/SFT/NOR/HRD(NOR)
Main Oct	Main Octave	Set the main voice octave	- 02 ~ 00 ~+ 02(00)
SplitOct	Split Octave	Set the split voice octave	- 02 ~ 00 ~+ 02(00)
LayerOct	Layer Octave	Set the layered voice octave	- 02 ~ 00 ~+ 02(00)
Transpos	Key Transpose	Adjust the key transpose	- 12 ~ 00 ~+ 12(00)
Tune	Master Tune	Adjust the master tune	- 64 ~ 00 ~+ 63(00)
Rev. Vol	Reverb Volume	Adjust the reverb volume	00 ~ 127 (45)
Rev. Type	Reverb Type	Set the reverb type 00 (Off), 01 (Room 1), 02 (Room 2), 03 (Room 3), 04 (Hall 1), 05 (Hall 2), 06 (Plate), 07 (Short Delay), 08 (Long Delay)	00 ~ 08 (03)
Eft. Vol	Effect Volume	Adjust the effect volume	00 ~ 127 (80)
Eft. Type	Effect Type	Set the effect type 00 (Off), 01 (Chorus 1), 02 (Chorus 2), 03 (Chorus 3), 04 (Chorus 4), 05 (Chorus 5), 06 (Delay 1), 07 (Delay 2), 08 (Delay 3)	00 ~ 08(00)
EQ. Bass	Bass EQ	Adjust Bass EQ	- 12 ~ 00 ~+ 12(06)
EQ. High	High EQ	Adjust High EQ	- 12 ~ 00 ~+ 12(01)
AutoPowr	Auto Power Off	Auto Power Off : ON/OFF	ON/OFF(ON)
L.Contrl	MIDI Local Control	MIDI Local control : ON/OFF	ON/OFF(ON)
Reset	Reset	Reset Piano	Enter to reset

Main/Split/Layer/Music Volume

All voice parts can be independently adjusted by using this function.

- When the music volume is adjusted, both the metronome and the music volume are adjusted.

Touch

The touch option determines the extent to which the volume of the piano responds to your playing strength(velocity). 4 different types are available for tailoring the keyboard response to the selected voice, type of song, or your own playing preference.

DISPLAY	TOUCH	DESCRIPTION
SOF	Soft	This setting lets you produce a relatively loud sound even when the keys are played softly.
NOR	Normal	This setting represents the standard degree of response of an ordinary keyboard, and is used as default.
HRd	Hard	This setting requires you to play the keys quite strongly to produce maximum loudness.
OFF	Off	These settings produce the same degree of loudness, no matter how strongly or softly you play the keys.

Main/Split/Layer Octave

In this function you can set the main voice octave, the layered voice octave and the split voice octave

Tune

The Tune function lets you make fine adjustments to the pitch, allowing you to accurately match the tuning with that of other instruments.

- The available range of tuning is from **-64 Hz to + 64 Hz**(Default **0**)
- Hz(Hertz)
The pitch is measured in units of Hertz(abbreviated Hz), which represents the number of times the sound wave vibrates in a second.
- The cent is a unit of pitch, equal to $1/100$ of a semitone.

Transpose

The TRANSPOSE function makes it possible to shift the pitch of the keyboard in semitone units, allowing you to match the pitch of the keyboard to the range of other instruments or singers, or letting you easily play in a different key without having to change your fingering. For example, if the TRANSPOSE is set F key, playing C results in a pitch of F, or in other words, you can play in the key of C major on the keyboard and automatically have the pitch transposed to F major.

- Pressing both UP and DOWN buttons simultaneously will instantly restore the default value(**0**).
- Range :- 12 semitone ~ 0 ~ 12 semitone(default **00**)

Reverb Volume

The reverb volume can be adjusted.

Reverb Type

There are 8 reverb types in the piano.

☒ 00 (Off), 01 (Room 1), 02 (Room 2), 03 (Room 3), 04 (Hall 1), 05 (Hall 2), 06 (Plate), 07 (Short Delay), 08 (Long Delay)

Effect Volume

Effect volume can be adjusted.

Effect Type

There are 8 effect types in the piano.

☒ 00 (Off), 01 (Chorus 1), 02 (Chorus 2), 03 (Chorus 3), 04 (Chorus 4), 05 (Chorus 5), 06 (Delay 1), 07 (Delay 2), 08 (Delay 3)

EQ

The piano has the 2 band equalizer.

☒ High and Bass sound can be adjusted by using the EQ.

Auto Power Off

The piano has the APO(Auto Power Off) function and you can turn off this function.

☒ Following 30 minutes of inactivity, the piano will be turned off automatically to preserve energy.

☒ Even after turning off the APO function, the piano will not be turned off automatically.

MIDI Local Control

Local Control refers to the control that the piano keyboard has on its internal sound system. When Local Control is set ON, the sound system belongs to the piano keyboard and what is played on the keyboard is reproduced via the piano speakers.

By turning this OFF, you can separate the connection between the keyboard and the sound system. When it is turned off, playing the keyboard does not trigger the speakers of the piano to make sound. The playing data is still transmitted to any external MIDI device connected to the piano, allowing you to control the external MIDI device with the piano keyboard without sounding the internal speakers of the piano.

RESET

Including recorded song, all functions and memories in the piano are set to default.

- ☒ If pressing the enter button in the reset menu, the piano starts resetting.
- ☒ It takes around 5 seconds to finish all resetting.
- ☒ Never disconnect the power during resetting.
- ☒ After resetting the LCD screen shows the initial display 'TEMPO '.

Recording

The piano features comprehensive song recording functions that allow you to record your own performance.

A song records 2 tracks and approx. 9,000 notes can be recorded into one track.

Recording and Playback

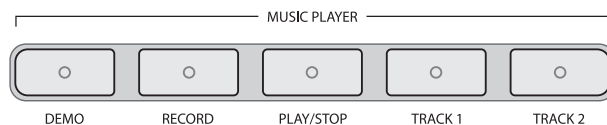

1 Prepare recording to the track 1

Select the desired voice and press both the RECORD and the TRACK 1 buttons. The record button will be lighted, and the track 1 button will begin flashing.

2 Start recording to the track 1.

Play the keyboard or press the RECORD button to begin the recording. Both buttons will be flashing.

- ☒ Any previously recorded music in the track will be deleted.

3 Stop recording to the track 1.

Press the TRACK 1 button or the RECORD button to stop the recording. The record button will be turned off, and the track 1 button will be lighted.

If you want to hear what is recorded in the track 1, press the PLAY/STOP button. The play button will be flashing throughout the playback.

4 Start recording to the track 2.

Press both the RECORD and the TRACK 2 button. The record button will be lighted, and the track 2 button will begin flashing.

Play the keyboard or press the RECORD button to begin the recording.

- ☒ If you wish not to hear what is recorded in the track 1 while recording to the track 2, press the track 1 button to turn it off. Otherwise, leave it turned on(lighted).
- ☒ Each track can be played individually.

5 Stop recording to the track 2.

Press either the TRACK 2 button or the RECORD button to stop the recording. The record button will be turned off, and the track 2 button will be lighted.

If you want to hear what is recorded in the track 2, press the PLAY/STOP button. The play button will be flashing throughout the playback.

6 Playback the recorded song.

Press the PLAY/STOP button.

- ☒ A lighted track button means that there is previously recorded material saved in that track.
- ☒ If you wish not to hear a track, turn off the button corresponding to that track.

7 Stop playback of the recorded song.

Press the PLAY button again.

CLEARING RECORDED MEMORY

To clear the recorded memory, Press both the RECORD and the PLAY/STOP buttons simultaneously.

- ☒ Recording new material will remove the pre-existing material in the track.
- ☒ Backing Up the recorded song
The recorded material will be preserved even after the power is turned off and then on again.

There are 50 classical tunes and 321 educational tunes in the demo music of this piano.

Demo Music

Classic Demo Music

There are 50 demo tunes in the piano.

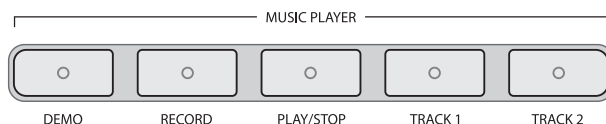

1 Enter the demo music mode.

Press the DEMO button. The LCD screen shows 'Classic'.

2 Go to the Classic Demo Music mode.

Press the ENTER button to go to the music select mode. The LCD screen shows the first number '01' of the classic demo music.

☒ The music selection mode can be automatically selected after 4 seconds without pressing the enter button.

3 Select a desired demo tune.

Select the demo tune by using the DATA UP or DOWN button.

4 Playback of the selected demo tune.

Press the PLAY button. Playback of the selected demo tune starts.

☒ Automatically start the next tune after finishing the playback.

☒ The music volume can be adjusted(See the setup mode on page 15,16 .)

☒ Whenever pressing the demo button, the piano goes to performance mode.

☒ If pressing the data up(or down) button, the music stops and the next(or before) tune is selected.

5 Stop music.

Press the PLAY button to stop the playback.

6 Exit the demo mode.

Press the DEMO button to exit the demo mode. The piano goes to the performance mode.

☒ To go to the music selection mode, press the ENTER button on the demo tune section mode.

Classic Demo Music List

DISPLAY	TITLE	COMPOSER
01	Etude op. 10 no. 1	Chopin, Fryderyk Franciszek
02	Etude op. 10 no. 4	
03	Etude op. 10 no. 5	
04	Etude op. 25 no. 9	
05	Nocturne op. 9 no. 1	
06	Nocturne op. 9 no. 2	
07	Nocturne op. 27 no. 2	
08	Nocturne op. 32 no. 1	
09	Nocturne op. 72 no. 1	
10	Sonata op. 3 no. 4	
11	Mazurka op. 7 no. 1	
12	Mazurka op. 30 no. 2	
13	Mazurka op. 67 no. 3	
14	Polonaise op. 40 no. 1	
15	Waltz op. 34 no. 1	
16	Waltz op. 64 no. 1	
17	Waltz op. 64 no. 2	
18	Waltz op. 69 no. 2	
19	Impromptu No. 4 c sharp minor(Fantasie-Impromptu) Op. 66	
20	Ballade op. 23 no. 1 in g minor	
21	Ballade op. 47 no. 3 in A flat Major	
22	Prelude op. 28 no. 1 in C Major- Agitato	
23	Prelude op. 28 no. 16 in b-flat minor- Presto con fuoco	
24	Piano Sonata no. 10 in C major, KV 330 I. Allegro moderato	Mozart, Wolfgang Amadeus
25	Piano Sonata no. 11 in A major, KV 331 I. Alla turca : Allegretto	
26	Piano Sonata no. 14 in c minor, KV 457 I. Adagio	
27	Piano Sonata no. 14 in c minor, KV 457 III. Assai allegro	
28	Variations "Ah! Vous dirai-je, Maman"	
29	Rondo in D major, KV 485	
30	Sonate no. 8 in c minor, op. 13 'Pathetique' Grave - Allegro molto e con brio	Beethoven, Ludwig van
31	Sonate no. 8 in c minor, op. 13 'Pathetique' II. Adagio cantabile	
32	Sonate no. 8 in c minor, op. 13 'Pathetique' III. Allegro	
33	Arabesque No. 1 in E major	Debussy, Claude Achille
34	Suite bergamesque 1. Prelude	
35	Suite bergamesque 3. Clair de lune	
36	Petite Suite, for piano 4-hands 2. Cortege	
37	Scenes from Childhood op. 15 From foreign lands and peoples in G major	Schumann, Robert Alexander
38	"12 Etudes d'execution transcendante(Transcendental Etudes), S Etude Transcendante in d minor, Mazeppa	139 Liszt, Franz
39	The flight of the bumble bee(by S. Rachmaninov)	Rimsky, Korsakov
40	Trois Gymnopedies 1. Lent et douloureux	Satie, Erik
41	12 Fantasie per clavicembalo(TWV 33)- Harpsichord music - 1. Fantasia	Telemann, Georq Philipp
42	12 Fantasie per clavicembalo(TWV 33)- Harpsichord music - 3. Fantasia	
43	12 Fantasie per clavicembalo(TWV 33)- Harpsichord music - 5. Fantasia	
44	12 Fantasie per clavicembalo(TWV 33)- Harpsichord music - 6. Fantasia	
45	12 Fantasie per clavicembalo(TWV 33)- Harpsichord music - 12. Fantasia	
46	Children's Album, Op. 39 No. 4 Mama	Tchaikovsky, Pyotr Ilyich
47	Prelude in C major, BWV 933	Bach, Johann Sebastian
48	Praludium und Fuge in B BWV 560 -Pipe Organ music -	
49	Wohltemperriertes Klavier-Pledudio 1	
50	Wohltemperriertes Klavier-Fuga 1	

Educational Demo Music

The Educational Music allows the user to practice the piano using a selection of built-in piano lesson music.

The left and right hand parts for each piece can be practiced separately, while adjusting the tempo allows difficult passages to be mastered.

1 Enter the demo music mode.

The LCD screen shows 'Classic' that is the first demo music group and the piano goes into the demo music mode. You can select a demo music group in this mode.

There are 5 educational music groups and 1 classic music group in this mode and each educational music group has same tunes as the listed piano lesson book.

Display	Buyer	Czerny 100	Czerny 30	Czerny 40	Sonatine
Tune	106	100	30	40	45

2 Select a desired tune.

Select a desired tune number in the selected music group by the DATA UP or DOWN button.

group.

- ☒ If you don't select any music for 4 seconds, the first tune will be automatically set.
- ☒ When a tune is selected, the left and right hand buttons light and you can mute the right or left hand parts by pressing the track 1 or 2 button.

3 Playback of the selected music.

Press the PLAY button. The selected music starts.

- ☒ This function can activate or deactivate the left and right-hand parts of selected lesson tune and enables the user to practice each part by pressing the left and right hand buttons.
- ☒ Automatically start the next tune after finishing the playback.
- ☒ The music volume can be adjusted(See the setup mode on page 15,16 .)
- ☒ Whenever pressing the demo button, the piano goes to performance mode.
- ☒ If pressing the data up(or down) button, the music stops and the next(or before) tune is selected.

4 Stop music.

Press the PLAY button to stop the playback.

5 Exit the demo mode.

Press the DEMO button to exit the demo mode. The piano goes to the performance mode.

- ☒ To go to the music selection mode, press the ENTER button on the demo tune section mode.

Sonatine Demo Music List

DISPLAY	TITLE	COMPOSER
011	Sonatine op. 20 no. 1 1movement	F. Kuhlau
012	Sonatine op. 20 no. 1 2movement	
013	Sonatine op. 20 no. 1 3movement	
021	Sonatine op. 20 no. 2 1movement	
022	Sonatine op. 20 no. 2 2movement	
023	Sonatine op. 20 no. 2 3movement	
031	Sonatine op. 20 no. 3 1movement	
032	Sonatine op. 20 no. 3 2movement	
033	Sonatine op. 20 no. 3 3movement	
041	Sonatine op. 55 no. 1 1movement	
042	Sonatine op. 55 no. 1 2movement	
051	Sonatine op. 55 no. 2 1movement	
052	Sonatine op. 55 no. 2 2movement	
053	Sonatine op. 55 no. 2 3movement	
061	Sonatine op. 55 no. 3 1movement	
062	Sonatine op. 55 no. 3 2movement	
.....		
071	Sonatine op. 36 no. 1 1movement	M. Clementi
072	Sonatine op. 36 no. 1 2movement	
073	Sonatine op. 36 no. 1 3movement	
081	Sonatine op. 36 no. 2 1movement	
082	Sonatine op. 36 no. 2 2movement	
083	Sonatine op. 36 no. 2 3movement	
091	Sonatine op. 36 no. 3 1movement	
092	Sonatine op. 36 no. 3 2movement	
093	Sonatine op. 36 no. 3 3movement	
101	Sonatine op. 36 no. 4 1movement	
102	Sonatine op. 36 no. 4 2movement	
103	Sonatine op. 36 no. 4 3movement	
111	Sonatine op. 36 no. 5 1movement	
112	Sonatine op. 36 no. 5 2movement	
113	Sonatine op. 36 no. 5 3movement	
121	Sonatine op. 36 no. 5 1movement	
122	Sonatine op. 36 no. 5 2movement	
.....		
131	Sonatine Hob. 16-35 1movement	J. Haydn
132	Sonatine Hob. 16-35 2movement	
133	Sonatine Hob. 16-35 3movement	
.....		
141	Sonatine K. 545 1movement	W.A. Mozart
142	Sonatine K. 545 2movement	
143	Sonatine K. 545 3movement	
.....		
151	Sonatine op. 49 no. 2 1movement	L.V. Beethoven
152	Sonatine op. 49 no. 2 2movement	
161	Sonatine op. 49 no. 1 1movement	
162	Sonatine op. 49 no. 1 2movement	
.....		
171	Sonatine op. 20 no. 1 1movement	J.L. Dussek
172	Sonatine op. 20 no. 1 2movement	

Drum and Sound FX Table

	Prog 1 Standard Drum	Prog 57 Sound FX
39 - D# 2	High Q	Jing
40 - E 2	Slap	Samul Drum 1
41 - F 2	Scratch Push	Samul Drum 2
42 - F# 2	Scratch Pull	Samul Cymbal 1
43 - G 2	Sticks	Soft/Loud
44 - G# 2	Square Click	Samul Cymbal 2
45 - A 2	Metronome Click	Long/Short
46 - A# 2	Metronome Bell	Samul Tong
47 - B 2	Kick drum 2/Jazz BD 2	Low
48 - C 2	Kick drum 1/Jazz BD 1	High
49 - C# 3	Side Stick	Sogo
50 - D 3	Snare Drum 1	Good/Very Good
51 - D# 3	Hand Clap	High Q
52 - E 3	Snare Drum 2	Slap
53 - F 3	Low Floor Tom	Scratch Push
54 - F# 3	Closed Hi Hat [EXC 1]	Scratch Pull
55 - G 3	High Floor Tom	Sticks
56 - G# 3	Pedal Hi-Hat [EXC 1]	Square Click
57 - A 3	Low Tom	Metronome Click
58 - A# 3	Open Hi-Hat [EXC 1]	Metronome Bell
59 - B 3	Low-Mid Tom	Guitar Slide
60 - C 4	Hi Mid Tom	Gt Cut Noise 1
61 - C# 4	Crash Cymbal 1	Gt Cut Noise 2
62 - D 4	High Tom	Double Bass Slap
63 - D# 4	Ride Cymbal 1	Key Click
64 - E 4	Chinese Cymbal	Laughing
65 - F 4	Ride Bell	Screaming
66 - F# 4	Tambourine	Punch
67 - G 4	Splash Cymbal	Heart Beat
68 - G# 4	Cowbell	Footsteps 1
69 - A 4	Crash Cymbal 2	Footsteps 2
70 - A# 4	Vibraslap	Applause
71 - B 4	Ride Cymbal 2	Door Creaking
72 - C 5	Hi Bongo	Door Closing
73 - C# 5	Low Bongo	Scratch
74 - D 5	Mute Hi Conga	Wind Chime
75 - D# 5	Open Hi Conga	Car Engine Start
76 - E 5	Low Conga	Car Breaking
77 - F 5	High Timbale	Car Pass
78 - F# 5	Low Timbale	Car Crash
79 - G 5	High Timbale	Police Siren
80 - G# 5	Low Agogo	Train
81 - A 5	Cabasa	Jet Take-off
82 - A# 5	Maracas	Helicopter
83 - B 5	Short Whistle[EXC 2]	Starship
84 - C 6	Long Whistle[EXC 2]	Gun Shot
85 - C# 6	Short Guiro[EXC 3]	Machinegun
86 - D 6	Long Guiro[EXC 3]	Lasergun
87 - D# 6	Claves	Explosion
88 - E 6	Hi Wood Block	Dog
89 - F 6	Low Wood Block	Horse Gallop
90 - F# 6	Mute Cuica[EXC 4]	Birds
91 - G 6	Open Cuica[EXC 4]	Rain
92 - G# 6	Mute Triangle[EXC 5]	Thunder
93 - A 6	Open Triangle[EXC 5]	Wind
94 - A# 6	Shaker	Sea Shore
95 - B 6	Jingle Bell	Stream
96 - C 7	Belltrees	Bubble
97 - C# 7	Castanets	Birds in Forest
98 - D 7	Mute Surdo[EXC 6]	Cricket
99 - D# 7	Open Surdo[EXC 6]	Bush Warbler
100 - E 7		

MIDI Implementation Chart

Function		Recognized	Transmitted	Remark
Basic Channel	Default	ALL	1-3	
Mode	Default	OMNI OFF, POLY	OMNI OFF, POLY	
Note ON/OFF	9nH kk w	0	0	#kk:note ON (0-127) #v:velocity (1-127)
Pitch Bender	EnH bi bh	0	0	Maximum swing +/- 1 tone
Control Change	00 BnH 00H cc	0	X	Bank Select
	01 BnH 01H cc	0	X	Modulation Wheel
	05 BnH 05H cc	0	X	Portamento Time
	06 BnH 06H cc	0	X	Data Entry
	07 BnH 07H cc	0	X	Volume
	10 BnH 0AH cc	0	X	Pan Out
	11 BnH 0BH cc	0	X	Expression
	64 BnH 40H cc	0	0	Sustain (Damper) Pedal
	65 BnH 41H cc	0	X	Portamento ON/OFF
	66 BnH 42H cc	0	0	Sostenuto Pedal
	67 BnH 43H cc	0	0	Soft Pedal
	80 BnH 80H w	0	X	Reverb Prog.(w=00H-70H)
	81 BnH 51H w	0	X	Chorus Prog.
	91 BnH 5BH w	0	0	Reverb Send Level
	93 BnH 5DH w	0	0	Chorus Send Level
120 BnH 78H 00H	0	X	All Sound Off	
121 BnH 79H 00H	0	X	Reset All Controller	
123 BnH 7BH 00H	0	X	All Notes Off	
126 BnH 7EH 00H	0	X	Mono On	
127 BnH 7FH 00H	0	X	Poly On	
Program Change	CnH PP	0	0	Sounds/Drum Set List
System Exclusive	General MIDI Reset	X	X	

O:Yes, X:No

Troubleshooting

If a problem occurs while using this product, check the points listed below first prior to contacting customer service.

Problem	Cause	Solution
The piano does not turn on.	<ol style="list-style-type: none"> 1) The power cord is not properly plugged. 2) The power switch is not pressed. (The button is lighted when it is pressed.) 3) Outlet is out of order. 	<ol style="list-style-type: none"> 1) Properly plug the power cord. 2) Press the power switch. 3) Try to plug the power cord of another home appliance into same electric outlet.
The speakers produce no sound when a key is played.	<ol style="list-style-type: none"> 1) The master volume is set to minimum. 2) A headphone is connected. 3) The power connection jack of the power cord is not properly connected to the product. 	<ol style="list-style-type: none"> 1) Increase the master volume. 2) Disconnect the headphone. 3) Properly connect the power connection jack to the product.
There are notable difference between the volumes of the main voice and the secondary voice.	<ol style="list-style-type: none"> 1) The secondary voice volume is set to a wrong value. 	<ol style="list-style-type: none"> 1) Set the secondary voice volume properly.
Random noise is heard when using the product.	<ol style="list-style-type: none"> 1) Other electric products such as a refrigerator or an electric washer are operating nearby. 2) The vibration comes from some objects on the piano when playing the piano. 3) Noise is heard when using the headphone. 	<ol style="list-style-type: none"> 1) Move the product faraway from other electric products, particularly those that use motors. 2) Firmly secure items causing the vibration or move them to another place. 3) Make the headphone plug clean or replace the headphone.
No sound is heard when using the product connected to an external sound device.	<ol style="list-style-type: none"> 1) The master volume is set to minimum. 2) The connecting cord is either cut or damaged. 3) Not connected in the right port. 	<ol style="list-style-type: none"> 1) Increase the master volume. 2) Replace the cord. 3) Make sure to properly connect into the right port.

Specifications

Section	Contents
PRODUCT	PORTABLE DIGITAL PIANO
KEYBOARD	88 KEYS(STANDARD) - 7 1/4 OCTAVES
TOUCH RESPONSE	OFF, SOFT, NORMAL, HARD
MAX. POLYPHONY	128 NOTES
SOUND	14 VOICES
	1 DRUM KIT
	1 SOUND EFFECT SET
FUNCTIONS	LAYER, SPLIT, TWIN PIANO, TUNE, TRANSPOSE, MIDI LOCAL CONTROL, PEDAL
DIGITAL SIGNAL PROCESSING	EFFECT(8), REVERB(8)
METRONOME	YES
DISPLAY	LCD Screen
DEMO MUSIC	CLASSIC 50 TUNES, EDUCATIONAL 321 TUNES - BUYER, CZERNY 100, 30, 40, SONATINE
RECORD	REAL-TIME-RECORDING 2 TRACKS APPROX. 18,000 NOTES(9,000 NOTES/TR)
VOLUME CONTROLS	MAIN, LAYER, SPLIT, DEMO, METRONOME LOW EQ GAIN, HIGH EQ GAIN, REVERB, EFFECT
I/O TERMINALS	USB IN, PEDAL IN, 3-PEDAL CONTROLLER, STEREO LINE OUT, PHONES
SPEAKER	3:6 INCHES × 2(STEREO 15W + 15W)
POWER	DC IN(12V)

WEEE Declaration



Your product is designed and manufactured with materials and components of high quality, which are recyclable and can be reused. The symbol means that your product should be disposed of separately from household waste when it reaches its end of life. Please dispose of this equipment at your local collection point or recycling center. Please help to protect the environment in which we all live.

All specifications and appearances are subject to change without notice. All information was correct at time of printing. Musikhaus Kirstein GmbH does not guarantee for the accuracy or completeness of any description, photograph or statement contained in this manual. Printed colors and specifications may vary slightly from product. Products from Musikhaus Kirstein GmbH are only sold through authorized dealer. Distributors and dealers are not agents of Musikhaus Kirstein GmbH and have no authority to bind Musikhaus Kirstein GmbH legally in any way. This manual is protected by copyright. Any copying or reprint, even in excerpts, is only allowed with written consent of Musikhaus Kirstein GmbH. The same applies to reproduction or copying of images, even in altered form.

 **KIRSTEIN.de**
We love music!

Musikhaus Kirstein GmbH

Address: Bernbeurener Str. 11
86956 Schongau
Germany

Telephone No.: 08861 / 90 94 94 - 0
Fax Nr.: 08861 / 90 94 94 - 19
Website: <https://www.kirstein.de/>
E-Mail: info@kirstein.de