

FUNKEY

DP-88 II Digitalpiano

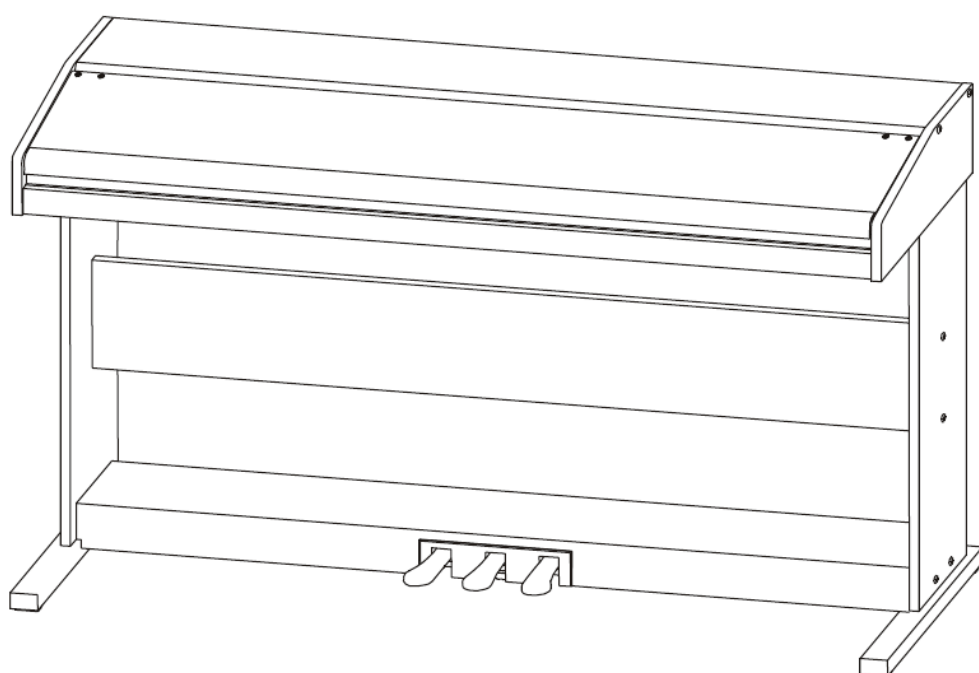

Bedienungsanleitung / User Manual

Version 05/2020

Einleitung

Herzlichen Dank, dass Sie sich für das **Funkey DP-88 II Digitalpiano** entschieden haben.

Wir wünschen Ihnen viel Spaß und Freude mit Ihrem neuen Funkey DP-88 II Digitalpiano.

Bitte lesen Sie diese Anleitung aufmerksam, um die praktischen Funktionen des **Funkey DP-88 II Digitalpianos** voll nutzen zu können.

Außerdem empfehlen wir Ihnen, dieses Handbuch an einem sicheren und leicht zugänglichen Ort aufzubewahren, um später darin nachschlagen zu können.

Achtung!

Vor dem ersten Einschalten und der Inbetriebnahme des Geräts lesen Sie auf Jeden Fall die Sicherheitsanweisungen durch um Verletzungen sowie Beschädigungen des Geräts zu vermeiden.

Bedienungsanleitung (deutsch) ab Seite 3

Introduction

Thank you for your purchase of the **Funkey DP-88 II Digitalpiano**.

We hope that you will enjoy the use of the Funkey DP-88 II Digitalpiano.

Please read through this manual carefully before beginning to use, so that you will be able to take full advantage of the **Funkey DP-88 II Digitalpiano** features and enjoy trouble-free operation for years to come.

Please keep this manual at a safe and dry place where you easily can access it.

Caution !

Before switching on the instrument or device read carefully the safety instructions to avoid serious injuries or damage of the product.

Operators manual (english) -> start from page 31

Informationen zu Ihrer Sicherheit

Bitte lesen Sie den folgenden Abschnitt sorgfältig durch, bevor Sie das Instrument in Gebrauch nehmen! Bitte bewahren Sie diese Bedienungsanleitung sorgfältig auf.

Stromversorgung

Bitte schließen Sie das mitgelieferte Netzkabel (ggf. Netzteil) an einer Steckdose mit korrekter Spannung an. Verbinden Sie das Gerät nicht mit einer Steckdose, deren Spannung für das Gerät nicht geeignet ist. Trennen Sie das Netzteil vom Strom, wenn Sie das Instrument nicht benutzen oder während eines Gewitters.

Anschlüsse

Bevor Sie das Instrument mit anderen Geräten verbinden, schalten Sie bitte alle Geräte zuerst aus. Das bewahrt die Geräte vor Schäden und hilft, Fehlfunktionen zu vermeiden.

Umgebung

Setzen Sie das Gerät den folgenden Bedingungen bitte nicht aus, um Verformungen, Verfärbungen oder ernsthaftere Schäden zu vermeiden:
direktem Sonnenlicht, extremen Temperaturen, extremer Feuchtigkeit, Staub oder Schmutz, starken Vibrationen oder Erschütterungen, magnetischen Feldern

Interferenzen

Sind Radio- oder Fernsehgeräte in der Nähe des Instruments aufgestellt, kann es zu Interferenzen kommen. Sollte das der Fall sein, stellen Sie die Geräte bitte weiter auseinander.

Reinigung

Bitte reinigen Sie das Instrument ausschließlich mit einem weichen, trockenen Tuch. Benutzen Sie bitte keine Farbverdünner, Lösungsmittel, Reinigungsflüssigkeiten oder chemisch imprägnierte Reinigungstücher.

Handhabung

Wenden Sie bitte keine übermäßige Gewalt beim Umgang mit Knöpfen und Schaltern an und sorgen Sie dafür, dass kein Papier, Metall oder sonstige Objekte in das Instrument gelangen können. Sollte es doch passieren, trennen Sie das Gerät bitte sofort vom Stromkreis und bringen Sie es zum Fachhändler zur Überprüfung. Entfernen Sie bitte stets alle Kabelverbindungen, bevor Sie das Instrument bewegen.

Öffnen des Geräts

Das Gerät darf nur von autorisiertem Fachpersonal zu Reparaturzwecken geöffnet werden. Wenden sie sich bitte an eine Fachwerkstatt oder den Händler bei welchem Sie das Gerät gekauft haben.

Inhaltsverzeichnis	
Anzeige- und Bedienelemente	6
Aufbau	8
Vorbereitung vor dem Spielen	10
Stromversorgung	10
Kopfhöreranschluss	10
Audio Equipment anschließen.....	10
Computer anschließen	10
Pedale anschließen	10
USB Anschluss	11
An-/Ausschalter.....	11
Anpassung der Lautstärke	11
Stimmauswahl	11
Primärstimme auswählen.....	11
Sekundärstimme auswählen (Dualvoice)	11
Touch-Funktion	11
Transpose.....	12
Piano Modus.....	12
Metronom.....	12
Begleitautomatik	12
Begleitautomatik einrichten	12
Lautstärke	12
Tempo	13
Auto-Chord Funktion.....	13
Full-Range-Chord Funktion.....	13
Akkordliste	13
Reverb	14
Chorus	14
Soundkonsole	14
Funktionen	15
Auf Werkseinstellungen zurücksetzen	15
Speicherfunktion	15
Aufnahmefunktion	15
Aufnahme starten/stoppen	16
Wiedergabe	16
Löschen von Aufnahmen	16
Vorgespeicherte Songs	16

Wiedergabe	16
Lernmodus.....	17
MP3-Wiedergabe	17
Stimmenliste	18
Styles Liste.....	24
Songlisten	27
WEEE-Erklärung / Entsorgung	30
Herstellerangaben	30

Anzeige- und Bedienelemente

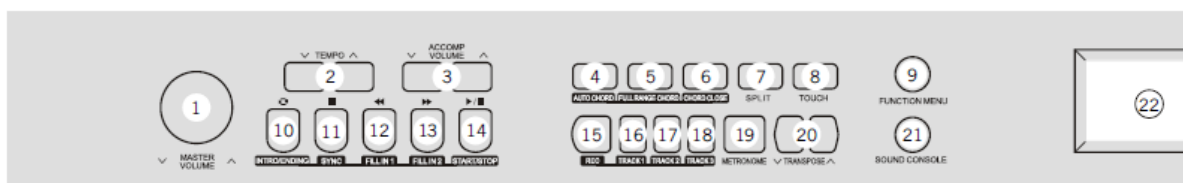

1 Lautstärkedrehrad

Passen Sie die Lautstärke an

2 Tempo Knöpfe

Passen Sie das Tempo an

3 Begleitlautstärke

Passen Sie die Begleitlautstärke an

4 Auto Chord Knopf

5 Full Range Chord Knopf

6 Chord Close Knopf

7 Split Knopf

8 Touch Knopf

9 Funktions Knopf

Betreten Sie das Funktionsmenü

Im Songmodus:

10

Setzen Sie den Anfangs-/Endpunkt für eine Dauerschleife

11

Pausieren Sie die Wiedergabe

12

Spulen Sie vor/zurück

13

Starten oder Beenden Sie die Wiedergabe

Im Stilmodus:

10 Intro/Ending Knopf

Spielen Sie ein automatisches Intro/Ending ab

11 Sync Knopf

Aktivieren/Deaktivieren Sie die Sync Funktion

12 FILL IN 1

Spielen Sie die Fill 1 Variation ab

13 FILL IN 2

Spielen Sie die Fill 2 Variation ab

14 Start/Stop

Starten oder Beenden Sie die Wiedergabe der Begleitautomatik

15 REC

Starten Sie die Aufnahmefunktion

16 TRACK 1

Wählen Sie Track 1 zur Aufnahme aus

17 TRACK 2

Wählen Sie Track 2 zur Aufnahme aus

18 TRACK 3

Wählen Sie Track 3 zur Aufnahme aus

19 Metronom

Aktivieren/Deaktivieren Sie das Metronom

20 Transpose

21 Soundkonsole

Betreten Sie das Soundkonsolen Menü

22 LCD Display

Hinteres Panel

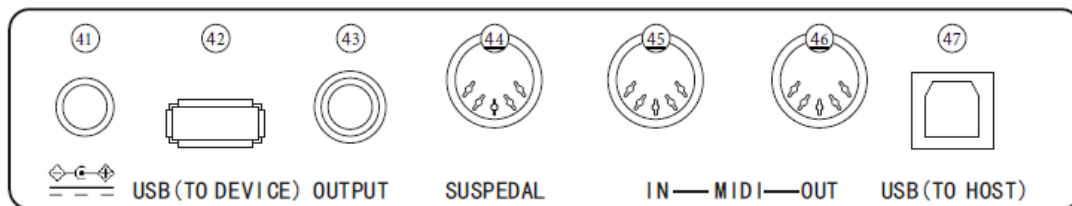

41 Stromanschluss

Schließen Sie hier das Netzteil an

42 USB Anschluss

43 Klinkenstecker Ausgang

44 Pedalanschluss

45 MIDI IN







46 MIDI OUT

47 USB MIDI Anschluss

Der **Kopfhöreranschluss** befindet sich als einzelne Klinkenbuchse links an der Unterseite des Instruments.

Aufbau

Kartoninhalt

①		TA4*12Schrauben	12stk
②		M6*50Schrauben	12stk
③		M6*20Schrauben	4stk
④		Hammermuttern 8stk	
⑤		Winkelverbinder	
⑥		Plastikabdeckung für M6 Schrauben	

Montage

1. Nutzen Sie die 12 TA4 Schrauben (1) um die 4 Winkelverbinder (5) an die linken und rechten Standfüße zu befestigen.
2. Befestigen Sie 8 Hammermuttern (4) in die passenden Löcher der linken und rechten Standfüße.
3. Nutzen Sie 4 M6x50 Schrauben (2) um die Standfüße mit den Bodenfüßen zu verbinden.
4. Befestigen Sie die hintere Wand mit den Standfüßen mit Hilfe 4 M6x50 Schrauben (2)
5. Befestigen Sie die Pedalbox an den Standfüßen mit Hilfe 4 M6x50 Schrauben und drehen Sie die Kunststoffschraube unter der Pedaleinheit bis zum Boden heraus.
6. Nun können Sie das Piano auf den Ständer auflegen und es mit Hilfe der M6x20 Schrauben (3) befestigen.

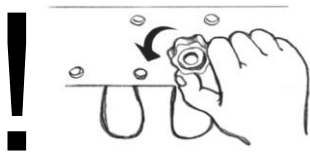
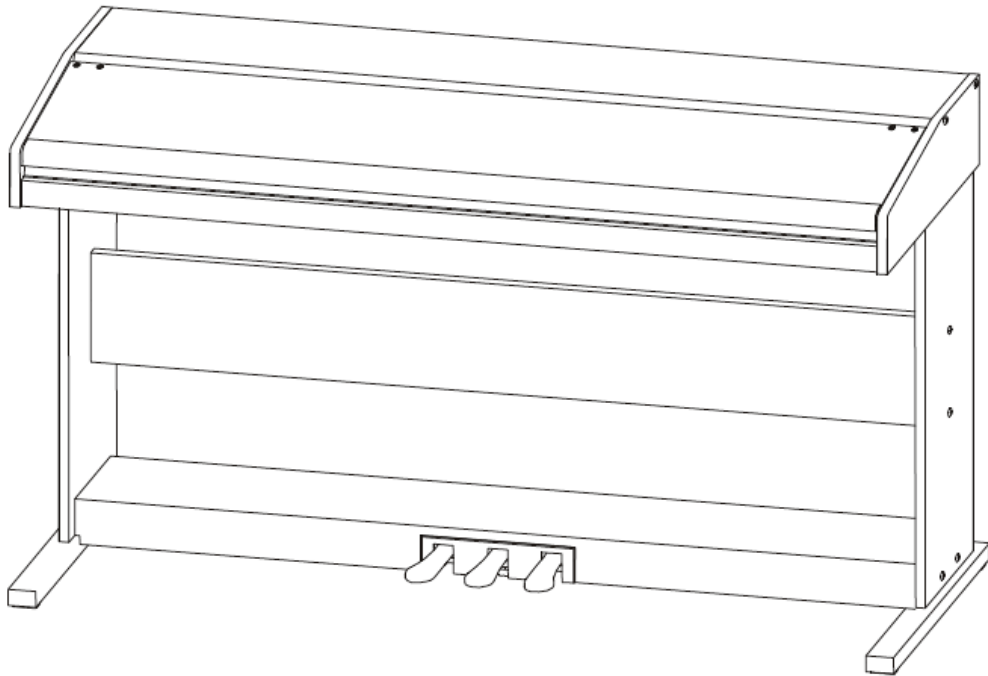
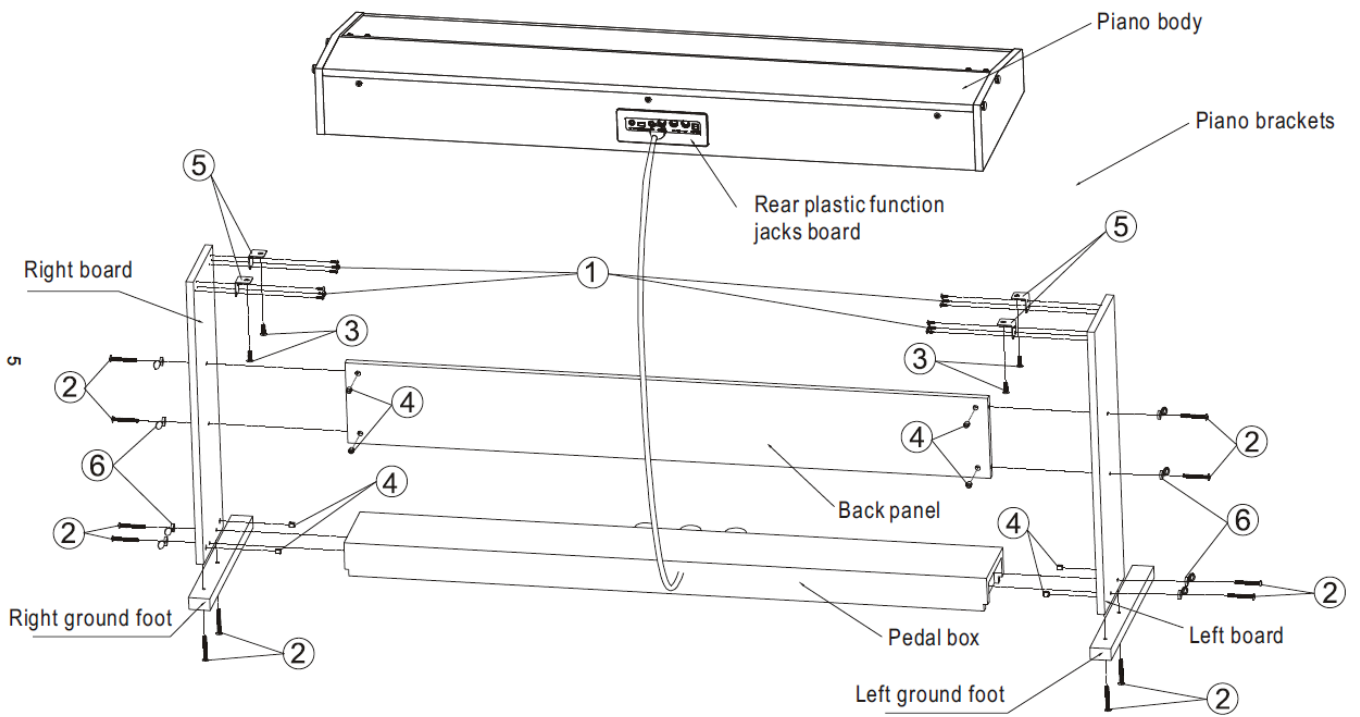

Vorbereitung vor dem Spielen

Stromversorgung

1. Stecken Sie das Netzteil in die Anschlussbuche am Piano und in Ihre Steckdose.
2. Schalten Sie das Piano mit Hilfe des POWER Knopfes an.

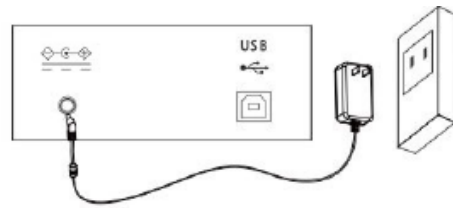

 Nutzen Sie nur das mitgelieferte Netzteil, da es ansonsten zu Schäden aufgrund von Spannungsunterschieden kommen kann.

Kopfhöreranschluss

Schließen Sie einen Kopfhörer mit einem 6,35 mm-Stecker an der passenden Buchse links an der Unterseite an. Dieser Kopfhörer dient zum persönlichen Monitoring oder wenn Sie üben möchten ohne andere Personen zu beeinträchtigen, beispielsweise nachts.

Audio Equipment anschließen

Es ist auch möglich externe Boxen an Ihr Piano anzuschließen um so ein besseres Sounderlebnis zu erhalten.

Computer anschließen

Das Piano verfügt über einen USB Anschluss mit dem es direkt an einen PC angeschlossen werden kann und dadurch MIDI Signale austauschen kann.

1. Verbinden Sie das Piano mit dem Computer.
2. Um das Piano als MIDI Gerät nutzen zu können müssen Sie die MIDI Software auf Ihrem Computer starten und den input/output auf das USB Gerät festlegen.
3. Um das Piano als Audiogerät zu verwenden, verbinden Sie das Piano mit dem PC und stellen Sie anschließend das Audiogerät des Computers auf das Piano um.

Pedale anschließen

1. Sustain Pedal (rechtes Pedal)

Das Betätigen dieses Pedals lässt die Noten auch dann klingen, wenn Sie diese gar nicht mehr drücken.

2. Sostenuto Pedal (mittleres Pedal)

Wenn Sie auf das Sostenutopedal treten, während Sie Tasten gedrückt halten, werden die Töne so lange ausgehalten, wie Sie das Pedal loslassen. Die anschließend gespielten Töne werden nicht ausgehalten sondern normal wiedergegeben. So können Sie beispielsweise einen Akkord mit Sustain versehen und andere Noten staccato spielen.

3. Soft Pedal (linkes Pedal)

Dieses Pedal reduziert die Lautstärke und ändert leicht das Timbre der gespielten Noten.

USB Anschluss

Mit Hilfe des USB Anschluss können Sie sehr einfach MP3-Dateien abspielen.

An-/Ausschalter

Schalten Sie hiermit Ihr Gerät an oder aus.

Anpassung der Lautstärke

Drehen Sie an diesem Rad um die Lautstärke anzupassen.

Stimmauswahl

Dieses Piano verfügt über die Fähigkeit, wie akustische, hochwertige Pianos/Flügel zu klingen und gleichzeitig wie andere Instrumente wie z.B. Schlagzeug zu klingen.

Primärstimme auswählen

1. Drücken Sie TONE. Das Display zeigt nun R1 an.
2. Wählen Sie mit Hilfe von + / - die gewünschte Stimme aus.

Sekundärstimme auswählen (Dualvoice)

1. Drücken Sie DUAL um die Funktion zu aktivieren. Das Display zeigt nun R2 an.
2. Wählen Sie mit Hilfe von + / - die gewünschte Stimme aus.
3. Nun hört es sich an als würden zwei Instrumente gleichzeitig spielen.
4. Drücken Sie DUAL erneut um die Funktion zu deaktivieren.



DUAL



Touch-Funktion

Diese Funktion bestimmt, in wie weit Ihre Anschlagskraft die Lautstärke des Sounds beeinflusst. Es stehen vier Einstellungsmöglichkeiten zur Verfügung, so dass Sie die Anschlagstärke der Art des Sounds, dem Song oder Ihren eigenen Vorlieben anpassen können.

Off: In dieser Einstellung klingen alle Töne gleich laut, egal wie fest oder zart Sie die Taste spielen.

Soft: Die Sounds klingen relativ laut, auch wenn Sie sanft spielen.

Normal: In dieser Einstellung klingt das Piano wie ein normales Klavier.

Hard: Sie müssen sehr kräftig spielen, um ein Maximum an Lautstärke zu erreichen.



TOUCH

Drücken Sie TOUCH um die Funktion zu aktivieren. Zur Auswahl des Modus drücken Sie TOUCH mehrfach.



Transpose

Mit dieser Funktion können Sie die Tonhöhe des Pianos in Halbtonschritten verändern um sie an andere Instrumente oder Sänger anzupassen. Sie können so ganz einfach die Tonart wechseln ohne Ihren Fingersatz anpassen zu müssen. Wenn z.B. Transpose F gewählt ist, ertönt ein F, wenn Sie ein C spielen. In anderen Worten: Sie können das Stück in C-Dur spielen und hören es transponiert auf F-Dur.

1. Drücken Sie Transpose v / Transpose ^ um den Modus zu aktivieren.
2. Ändern Sie den Wert mit v / ^ (-012 - +012).
3. Der Standardwert ist hierbei 000.



Piano Modus

Drücken Sie PIANO um den Modus zu aktivieren.



Metronom

Falls Sie sich noch nicht sicher fühlen können Sie das Metronom aktivieren um die Einhaltung des Takts zu lernen.

Drücken Sie hierfür METRONOM um es zu aktivieren/deaktivieren.



Begleitautomatik

Ihr Instrument besitzt über verschiedene Begleiter welche Sie verwenden können um Ihr gespieltes mit einem vollen Orchester als Begleiter zu ergänzen. Während diese Funktion aktiviert ist kreiert der automatische Begleiter abhängig von Ihren gespielten Akkorden und Noten im unten abgebildeten Bereich passende Töne. Der restliche Teil des Pianos ist immer noch für normales Spielen ohne Begleiter verfügbar.

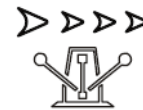

Begleitautomatik einrichten

1. Drücken Sie STYLE um in den Stilmodus zu gelangen.
2. Wählen Sie den Begleitmodus mit Hilfe von + / - aus.
3. Starten Sie die Wiedergabe mit Hilfe von START/STOP.



Hinweis: Ihr Piano verfügt neben den verschiedenen Stilen über eine Intro- bzw. Ending-Funktion sowie über zwei verschiedene Fill In-Funktionen.

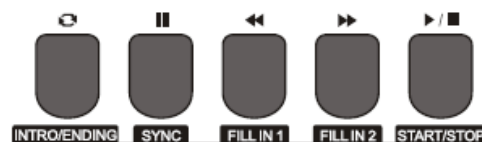

Lautstärke

Passen Sie die Lautstärke mit Hilfe der ACCOMP VOLUME ^ / v Knöpfe an.



Tempo

Jeder Stil verfügt über ein eigenes Tempo, welches Sie jederzeit anpassen können. Drücken Sie hierzu die TEMPO ^/v Knöpfe

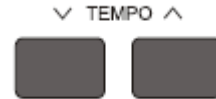

Auto-Chord Funktion

Nach dem Drücken von AUTO CHORD spielt das Piano passende Akkorde zu den von Ihnen gespielten Noten (Nur die linke Hand ist betroffen).



Full-Range-Chord Funktion

Nach dem Drücken von AUTO CHORD spielt das Piano passende Akkorde zu den von Ihnen gespielten Noten (Beide Hände sind betroffen).

Akkordliste

Original name	Abbr.	Normal pronunciation
MAJOR	M	1-3-5
MAJOR SIXTH	M6	1-3-5-6
MAJOR SEVENTH	M7	1-3-(5)-7
MAJOR SEVENTH SHARP ELEVENTH	M7#11	1-(2)3# 4-(5)-7
MAJOR ADD NINTH	Madd9	1-2-3-5
MAJOR NINTH	M9	1-2-3-(5)-7
MAJOR SIXTH ADD NINTH	69	1-2-3-(5)-6
AUGMENTED	aug	1-3-#5
MINOR	m	1 ^b 3-5
MINOR SIXTH	m6	1 ^b 3-5-6
MINOR SEVENTH	m7	1- ^b 3-(5)-7
MINOR SEVENTH FLATTED FIFTH	m7 ^b 5	1-3-5-7
MINOR ADD NINTH	madd9	1-2-3-5
MINOR ADD NINTH	m9	1-2-3-5
MINOR MAJOR ELEVENTH	m11	1-3-(5)-7
MINOR MAJOR SEVENTH	mM7	1- ^b 3-(5)-7
MINOR MAJOR NINTH	mM9	1-2-3-(5)-7
DIMINISHED	dim	1-3-5
DIMINISHED SEVENTH	dim7	1-3-5-6
SEVENTH	7	1-3(5)-7
SEVENTH SUSLEND FOURTH	7sus4	1-4-5-7
SEVENTH NINTH	79	1-2-3-(5)-7
SEVENTH SHARP ELEVENTH	7#11	1-(2)3-#4-(5)-b7
SEVENTH THIRTEENTH	713	1-3-(5)-7 / 2-3-5-6-7

Original name	Abbr.	Normal pronunciation
SEVENTH FLATTED NINTH	7 ^b 9	1-2-3-(5)-7
SEVENTH FLATTED THIRTEENTH	7 ^b 13	1-3-5-6-7
SEVENTH SHARP NINTH	7 [#] 9	(1)- [#] 2-3-(5)-7
MAJOR SEVENTH AUGMENTED	M7 ^{aug}	1-3 [#] -5-7
SEVENTH AUGMENTED	7 ^{aug}	(1)-3- [#] 5-7
SUSPENED FOURTH	sus4	1-4-5
ONE PLUS TWO PLUS FIVE	1+2+5	1-2-5

Reverb

Die Reverb Funktion kann durch drücken der REVERB Taste aktiviert/deaktiviert werden.



Chorus

Die Chorus Funktion kann durch drücken der CHORUS Taste aktiviert/deaktiviert werden.



Soundkonsole

Hier können die einzelnen Instrumentenlautstärken in vorgefertigten Songs angepasst werden (z.B. die Lautstärke der linken Hand oder die Basslautstärke).

1. Drücken Sie SOUND CONSOLE und passen Sie die Parameter mit Hilfe von +/- an.



Adjustment content	LCD display	Adjustment range
Percussion music track volume	XXX Rhythm	0 - 127
Bass track volume	XXX Bass	0 - 127
Hamony track volume	XXX Chord	0 - 127
Phrase track volume	XXX Phrase	0 - 127
left hand track volume	XXX Lower	0 - 127
Right hand track volume	XXX Upper	0 - 127

Funktionen

Im Funktionsmenü können Sie einzelne Parameter der Funktionen anpassen und so personalisieren. Dies geschieht mit den + / - Tasten des Pianos.

1. Drücken Sie FUNCTION MENU um in das Menü zu gelangen.
2. Wählen Sie mit Hilfe von FUNCTION MENU + oder FUNCTION MENU - die gewünschte Zeile aus.
3. Nun kann der Wert mit Hilfe von + / - geändert werden.



Serial no.	Adjustment content	LCD Display	Adjustment range	Presetting value
1	Tune	XXX Tune	-50 ~ +50	000
2	Keyboard split	XXX KeySplit	1 ~ 88	034
3	Beat type	XXX BeatType	0, 2 ~ 9	004
4	Metronome volume	XXX MetroVol	0~127	080
5	Reverb depth	XXX Revb Lev	0~127	050
6	Chorus depth	XXX Chor Lev	0~127	000
7	MIDI Receiving	XXX Midi In	1 ~ 16, ALL	ALL
8	MIDI Sending	XXX Midi Out	1 ~ 16	001

Auf Werkseinstellungen zurücksetzen

Drücken Sie + / - während das Gerät ausgeschaltet ist um es auf den Werkszustand zurückzusetzen. Schalten Sie anschließend das Gerät an. Anschließend wird das Gerät sämtliche Daten löschen.

Speicherfunktion

Das Gerät verfügt über eine Speicherfunktion, welche es Ihnen ermöglicht bestimmte Einstellungen abzuspeichern und somit schnell abzurufen. Hierfür stehen Ihnen zwei Speicherplätze und vier Speicherbänke zur Verfügung. Sie haben also insgesamt 8 Speichermöglichkeiten.

1. Drücken Sie STORE und anschließend M1 oder M2 um den Speicherplatz auszuwählen.
2. Um die Speicherbank zu wechseln drücken Sie BANK.
3. Drücken und halten Sie STORE und M1 um alle Speicherplätze und Speicherbänke zu leeren.



Aufnahmefunktion

Mit Hilfe dieser Funktion können Sie eigene Songs aufnehmen und jederzeit abspielen. Das Piano verfügt über drei Tracks.

Hierbei ist TRACK1 für die Aufnahme der Begleitfunktion vorgesehen. TRACK2 und TRACK3 können zur Aufnahme zweier getrennter Melodiespuren (z.B. linke und rechte Hand) genutzt werden.

Aufnahme starten/stoppen

1. Drücken Sie 2x RECORD. Unter der Tempoangabe im Display blinken nun vier Pfeile und signalisieren die Aufnahmebereitschaft. Das Display zeigt RecSong1. Drücken Sie +/- falls Sie einen anderen User-Speicherplatz auswählen möchten.
2. Wählen Sie die gewünschte Stimme, den gewünschten Style und das passende Tempo aus und drücken Sie TRACK 1, TRACK 2 oder TRACK 3. Durch mehrmaliges Drücken der jeweiligen TRACK-Taste ändern Sie den Status der jeweiligen Aufnahmespur. Blinkende Anzeige -> Aufnahmebereit, leuchtende Anzeige bei bereits aufgenommenen Musikdaten -> Dieser Track wird parallel zur Aufnahme wiedergegeben, keine Anzeige -> Dieser Track ist deaktiviert.
3. Um die Aufnahme zu starten drücken Sie START/STOP. Dasselbe gilt für das Stoppen der Aufnahme.



Wiedergabe

Drücken Sie nach erfolgreicher Aufnahme RECORD um den aufgenommenen Song abzuspielen. Stoppen Sie die Wiedergabe mit Start/Stop. Hierbei können durch Drücken der TRACK-Tasten, die einzelnen Spuren der Aufnahme aktiviert, bzw. deaktiviert werden. Nach Verlassen der Aufnahmefunktion finden Sie Ihre Aufnahme im Song-Modus hinter den vorinstallierten Songs als sogenannte User-Songs.

Löschen von Aufnahmen

1. Um alle Songs zu löschen drücken und halten Sie RECORD während das Gerät ausgeschaltet ist, betätigen den Netzschalter und drücken sofort anschließend zusätzlich die SONG-Taste. Nach erfolgreichem Start des Instrumentes können Sie beide Tasten wieder loslassen. Alle User-Songs sind nun gelöscht.
2. Um einen einzelnen Song oder einzelne Spuren zu löschen aktivieren Sie den Aufnahmemodus. Hierzu drücken Sie 2x RECORD. Unter der Tempoangabe im Display blinken nun vier Pfeile. Drücken Sie RECORD für ca. zwei Sekunden. Wählen Sie nun TRACK 1, TRACK 2 oder TRACK 3. Das LCD Display zeigt „Delete?“.
3. Drücken Sie + um das Löschen zu bestätigen oder – um den Vorgang abubrechen.



Vorgespeicherte Songs

Wiedergabe

1. Drücken Sie SONG um den Songmodus zu aktivieren.
2. Wählen Sie mit Hilfe von + / - den gewünschten Song aus und bestätigen Sie diesen mit START/STOP.

Lernmodus

1. Drücken Sie LESSON.
2. Wählen Sie mit Hilfe von LEFT / RIGHT die gewünschte Hand aus.
3. Wählen Sie den gewünschten Modus mit Hilfe mehrmaligen Drücken des LESSON Knopfes aus.
4. Bestätigen Sie den Modus mit START/STOP.



Hinweis: Dieser Modus funktioniert nur im Songmodus während einer Wiedergabe eines Songs.

MP3-Wiedergabe

Die nebenstehende Grafik zeigt die Bedienmöglichkeiten bei der MP3-Wiedergabe.

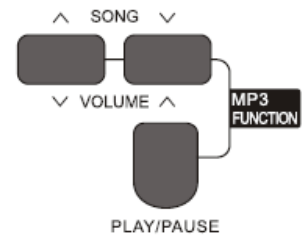

Stimmenliste

Classify	No.	Full english Name	English Abbr
Piano	1	Stereo Grand Piano	StGrdPno
Piano	2	Acoustic Grand Piano (wide) 1	GrandPnW
Piano	3	Acoustic Grand Piano (dark)	GrandPnD
Piano	4	Octave Piano 1	OctPno1
Piano	5	Octave Piano 2	OctPno2
Piano	6	Piano & Strings	Pno&Str
Piano	7	Piano & Choir	Pno&Cho
Piano	8	Acoustic Grand Piano	GrandPno
Piano	9	Stereo Bright Piano	StBrnPno
Piano	10	Bright Acoustic Piano	BritePno
Piano	11	Bright Acoustic Piano (wide) 1	BritePnW
Piano	12	Chorus Piano	ChoruPno
Piano	13	Electric Grand Piano	E.Grand
Piano	14	Electric Grand Piano (wide)	E.GrandW
Piano	15	Stereo Honk-Tonk	StHonkTo
Piano	16	Honky-tonk Piano	HnkyTonk
Piano	17	Honky-tonk Piano (wide) 1	HnyTonkW
Piano	18	Stereo Hard Electric Piano	StHarEp
Piano	19	Detuned Electric Piano 1	DetunEP1
Piano	20	Detuned Electric Piano 2	DetunEP2
Piano	21	Electric Piano 1	E.Piano1
Piano	22	Electric Piano 2	E.Piano2
Piano	23	Electric Piano (wide) 1	EPnoW1
Piano	24	Electric Piano (wide) 2	EPnoW2
Piano	25	EP Legend	EPLegend
Piano	26	EP Phase	EPPhase
Piano	27	60's Electric Piano	60'sEP
Piano	28	Electric Piano 1 (velocity mix)	E.PnoV1
Piano	29	Electric Piano 2 (velocity mix)	E.PnoV2
Piano	30	Velocity Crossfade Electric Piano	VeCrosEP
Piano	31	Layered Electric Piano 1	LayerEP1
Piano	32	Layered Electric Piano 2	LayerEP2
Piano	33	Nylon Electric Piano	NylonEP
Piano	34	Warm Electric Piano	WarmEP
Piano	35	Grand Harpsichord	GraHarps
Piano	36	Harpsichord 1	Harpsi
Piano	37	Harpsichord 2	Harpsi2
Piano	38	Harpsichord (wide)	HarpsiW
Piano	39	Harpsichord (octave mix) 1	HarpsiO
Piano	40	Harpsichord Release	HarpsiR
Piano	41	Harpsichord (with key off)	HarpsiOf
Piano	42	Clavi 1	Clavi
Piano	43	Clavi 2	Clavi 2
Piano	44	Clavi (wide) 1	ClaviW1
Piano	45	Clavi (wide) 2	ClaviW2
Piano	46	Clavi Wah	ClaviWa
Piano	47	Pulse Clavi	PulseClv
Chromatic Percussion	48	Celesta 1	Celesta
Chromatic Percussion	49	Celesta 2	Celesta2
Chromatic Percussion	50	Birght Celesta	BirCelea
Chromatic Percussion	51	Celesta & Sine	Celes&Si
Chromatic Percussion	52	Reecho Bell	ReechBell
Chromatic Percussion	53	Celesta & Music Box	Celes&MB
Chromatic Percussion	54	Glockenspiel 1	Glocken
Chromatic Percussion	55	Glockenspiel 2	Glocken2
Chromatic Percussion	56	Music Box 1	MusicBox
Chromatic Percussion	57	Music Box 2	MusicBo2
Chromatic Percussion	58	Music Box 3	MusicBo3
Chromatic Percussion	59	Toy Box	ToyBox
Chromatic Percussion	60	Music Box & Harp	Mbx&Harp
Chromatic Percussion	61	Stereo Vibrapho	StVibes
Chromatic Percussion	62	Rigid Vibraphone	RigiVibe

Classify	No.	Full english Name	English Abbr
Chromatic Percussion	63	Vibraphone 1	Vibra
Chromatic Percussion	64	Vibraphone 2	Vibra2
Chromatic Percussion	65	Vibraphone (wide) 1	VibraW
Chromatic Percussion	66	Vibraphone (wide) 2	VibraW2
Chromatic Percussion	67	Vibraphone & Bell	Bell&Vib
Chromatic Percussion	68	Marimba 1	Marimba
Chromatic Percussion	69	Marimba 2	Marimba2
Chromatic Percussion	70	Marimba (wide)	MarimbaW
Chromatic Percussion	71	Stereo Marimba	StMarim
Chromatic Percussion	72	Marimba & Vibraphone	Mar&Vib
Chromatic Percussion	73	Xylophone 1	Xylophone
Chromatic Percussion	74	Xylophone 2	Xylopho2
Chromatic Percussion	75	Tubular Bells	TubulBell
Chromatic Percussion	76	Church Bell	ChurBell
Chromatic Percussion	77	Carillon	Carillon
Chromatic Percussion	78	Dulcimer	Dulcimer
Chromatic Percussion	79	Santur	Santur
Organ	80	Drawbar Organ 1	DrawbOrgan
Organ	81	Drawbar Organ 2	DrawbOrgan 2
Organ	82	Soft Stereo Drawbar Organ	SfDrawOrgan
Organ	83	Mellow Drawbar Organ	MellDrOr
Organ	84	Detuned Drawbar Organ 1	DeDraOr
Organ	85	Detuned Drawbar Organ 2	DeDraOr2
Organ	86	Italian 60's Organ	60'sOrgn
Organ	87	1970 Percussive Organ	1970PcOr
Organ	88	Percussive Organ 1	PercOrgn1
Organ	89	Percussive Organ 2	PercOrg2
Organ	90	Light Click Organ	LClickOr
Organ	91	Detuned Percussive Organ	DePerOrg
Organ	92	Stereo Rotary Organ	StRotaOr
Organ	93	Rock Organ	RockOrgn
Organ	94	Rotary Organ	RotaOrgn
Organ	95	Slow Rotary Organ	SloRotOr
Organ	96	Detuned Church Organ	DeChuOrg
Organ	97	Church Organ 1	ChurOrgn
Organ	98	Church Organ 2	ChurOrg2
Organ	99	Church Organ (octave mix)	ChurOrgO
Organ	100	Reed Organ	ReedOrgn
Organ	101	Puff Organ	PuffOrgn
Organ	102	Accordion 1	Accordion
Organ	103	Accordion 2	Accordin2
Organ	104	Accordion 3	Accordin3
Organ	105	Mustte	Mustte
Organ	106	Accord It Solo	AccordSo
Organ	107	Sweet Harmonica	SwetHarm
Organ	108	Harmonica 1	Harmonica
Organ	109	Harmonica 2	Harmonic2
Organ	110	Tango Accordion	TangoAcd
Guitar	111	Acoustic Guitar (nylon) 1	NylonGtr
Guitar	112	Acoustic Guitar (nylon) 2	NylonGt2
Guitar	113	Acoustic Guitar (nylon + key off)	NylGtrOf
Guitar	114	Ukulele	Ukulele
Guitar	115	Velocity Nylon Guitar	NylnGtVe
Guitar	116	Chorus Nylon Guitar	ChoNyGt
Guitar	117	Bright Nylon Guitar	BrNyGt
Guitar	118	Acoustic Guitar (steel) 1	SteelGtr
Guitar	119	Acoustic Guitar (steel) 2	SteelGt2
Guitar	120	Steel Guitar with Body Sound	SteelBdy
Guitar	121	Tremolo Steel Guitar	TremGt
Guitar	122	Mandolin	Mandolin
Guitar	123	12-Strings Guitar	12StrGtr
Guitar	124	Chorus Steel Guitar	ChoSteGt

Classify	No.	Full english Name	English Abbr
Guitar	125	Nylon & Steel Guitar	Ny&SteGt
Guitar	126	Stereo Steel Guitar	StSteGt
Guitar	127	Steel Guitar Bend	GtBend
Guitar	128	Steel Guitar Harmonics	GtHarm
Guitar	129	Velocity Steel Guitar 1	VelSte1
Guitar	130	Velocity Steel Guitar 2	VelSte2
Guitar	131	Velocity Steel Guitar 3	VelSte3
Guitar	132	Electric Guitar (jazz) 1	JazzGtr
Guitar	133	Electric Guitar (jazz) 2	JazzGt2
Guitar	134	Electric Guitar (pedal steel)	PedalGtr
Guitar	135	Mellow Guitar	MellGt
Guitar	136	Velocity Jazz Guitar	JazzGtVe
Guitar	137	Jazz Guitar Detuned	JazzGtDt
Guitar	138	Mid Tone Guitar	MidTonGt
Guitar	139	Electric Guitar (clean) 1	CleanGtr
Guitar	140	Electric Guitar (clean) 2	CleanGtr2
Guitar	141	Stereo Clean Guitar	StCleGtr
Guitar	142	Velocity Clean Guitar	CleGtVel
Guitar	143	Electric Guitar (detuned clean)	DetClnGt
Guitar	144	Electric Guitar (muted velo-sw)	MutVelGt
Guitar	145	Electric Guitar (muted)	MutedGtr
Guitar	146	Electric Guitar (funky cutting)	FunkGt
Guitar	147	Jazz Man	JazzMan
Guitar	148	Stereo Muted Guitar	StMuGt
Guitar	149	Guitar Pinch	GtPinch
Guitar	150	Overdriven Guitar	Overdrive
Guitar	151	Distortion Guitar 1	DistGt
Guitar	152	Distortion Guitar 2	DistGtr2
Guitar	153	Distortion Guitar (with feedback) 1	FeedbkGt
Guitar	154	Distorted Rhythm Guitar	DistRyth
Guitar	155	5th Distortion	5thDist
Guitar	156	Stereo Distorted Guitar	StDistor
Guitar	157	Guitar Feedback	GtFdbk
Guitar	158	Guitar Harmonics	GtrHarmo
Bass	159	Acoustic Bass 1	AcoBass
Bass	160	Acoustic Bass 2	AcoBass2
Bass	161	Jazz Style	JazzSty
Bass	162	A.Bass & Mute G.T.	Ba&GtMu
Bass	163	Resonant Bass	ResBass
Bass	164	Wah Bass 1	WahBass1
Bass	165	Electric Bass (finger) 1	FngrBass
Bass	166	Electric Bass (finger) 2	FngrBas2
Bass	167	Electric Bass (finger) 3	FngrBas3
Bass	168	Finger Slap Bass	FngrSlap
Bass	169	Electric Bass (pick) 1	PickBass
Bass	170	Electric Bass (pick) 2	PickBas2
Bass	171	Fretless Bass 1	Fretless
Bass	172	Fretless Bass 2	Fretless2
Bass	173	Slap Bass 1	SlapBass
Bass	174	Slap Bass 2	SlapBass2
Bass	175	Synth Bass 1	SynBass
Bass	176	Synth Bass 2	SynBass2
Bass	177	Synth Bass 3 (resonance)	ResoBass
Bass	178	Synth Bass 4 (attack)	AtackBass
Bass	179	Synth Bass (warm)	WarmBass
Bass	180	Clavi Bass	ClavBass
Bass	181	Hammer	Hammer
Bass	182	Synth Bass (rubber)	RubbBass
Bass	183	Attack Pulse	AtackPls
Strings & Orchestral Instruments	184	The Violin	TheVin
Strings & Orchestral Instruments	185	Violin 1	Violin

Classify	No.	Full english Name	English Abbr
Strings & Orchestral Instruments	186	Violin 2	Violin2
Strings & Orchestral Instruments	187	Violin (slow attack)	SlViolin
Strings & Orchestral Instruments	188	Soft Violin	SoftVin
Strings & Orchestral Instruments	189	Viola 1	Viola
Strings & Orchestral Instruments	190	Viola 2	Viola2
Strings & Orchestral Instruments	191	Cello 1	Cello
Strings & Orchestral Instruments	192	Cello 2	Cello2
Strings & Orchestral Instruments	193	Celloen 16'	Celloen
Strings & Orchestral Instruments	194	Contrabass 1	Contrabs
Strings & Orchestral Instruments	195	Contrabass 2	Contrbs2
Strings & Orchestral Instruments	196	Tremolo Strings 1	TremStr
Strings & Orchestral Instruments	197	Tremolo Strings 2	TremStr2
Strings & Orchestral Instruments	198	Pizzicato Strings 1	PizzStr
Strings & Orchestral Instruments	199	Pizzicato Strings 2	PizzStr2
Strings & Orchestral Instruments	200	Orchestral Harp 1	Harp
Strings & Orchestral Instruments	201	Orchestral Harp 2	Harp2
Strings & Orchestral Instruments	202	Timpani 1	Timpani
Strings & Orchestral Instruments	203	Timpani 2	Timpani2
Ensemble	204	String Ensembles 1	Strings1
Ensemble	205	String Ensembles 2	Strings2
Ensemble	206	Synth Strings 1	SynStrs1
Ensemble	207	Synth Strings 2	SynStrs2
Ensemble	208	Synth Strings 3	SynStrs3
Ensemble	209	Synth Strings 4	SynStrs4
Ensemble	210	Stereo Slow Strings	SSlowStr
Ensemble	211	Strings and Brass	Str&Bras
Ensemble	212	Legato Strings	LegatStr
Ensemble	213	Orchestra	Orchstr
Ensemble	214	60's Strings	60'sStr
Ensemble	215	Solo Strings	SoloStr
Ensemble	216	Choir Aahs 1	ChoirAah
Ensemble	217	Choir Aahs 2	ChoirAh2
Ensemble	218	Humming	Humming
Ensemble	219	Voice Oohs	VoiceOoh
Ensemble	220	Analog Voice	AnaVoice
Ensemble	221	Synth Voice	SynVoice
Ensemble	222	Bass Hit Plus	BassHit
Ensemble	223	Orchestra Hit 1	OrchHit
Ensemble	224	Orchestra Hit 2	OrchHi2
Ensemble	225	Euro Hit	EuroHit
Ensemble	226	6th Hit	6thHit
Brass	227	Trumpet 1	Trumpet
Brass	228	Trumpet 2	Trumpet2
Brass	229	Trumpet 3	Trumpet3
Brass	230	Dark Trumpet Soft	DarkTrp
Brass	231	Sweet Trumpet	SweetTp
Brass	232	Trombone 1	Trombone
Brass	233	Trombone 2	Trmbone2
Brass	234	Bright Trombone	BritBone
Brass	235	Tuba 1	Tuba
Brass	236	Tuba 2	Tuba2
Brass	237	Muted Trumpet 1	MuteTrp1
Brass	238	Muted Trumpet 2	MuteTrp2
Brass	239	French Horn 1	FrHorn
Brass	240	French Horn 2 (warm)	FrHorn2
Brass	241	Brass Section 1	Brass
Brass	242	Brass Section 2 (octave mix)	Brass2
Brass	243	Brass Section 3	Brass3
Brass	244	Brass Section 4	Brass4
Brass	245	Brass Section 5	Brass5
Brass	246	Brass Band	BrasBand

Classify	No.	Full english Name	English Abbr
Brass	247	Bright Brass Section	BrBraSec
Brass	248	Brass & Strings	Bras&Str
Brass	249	Synth Brass 1	SynBras1
Brass	250	Synth Brass 2	SynBras2
Brass	251	Synth Brass 3	SynBras3
Brass	252	Synth Brass 4	SynBras4
Brass	253	Analog Synth Brass 1	AnaBras1
Brass	254	Analog Synth Brass 2	AnaBras2
Brass	255	Jump Brass	JumpBras
Brass	256	Synth Brass & Strings 1	SyBr&St1
Reed	257	Soprano Sax 1	SprnoSax
Reed	258	Soprano Sax 2	SprnSax2
Reed	259	Sweet Soprano Sax	SweSpSax
Reed	260	Alto Sax	AltoSax
Reed	261	Soft Alto Sax	SoftAlto
Reed	262	Tenor Sax 1	TenorSax
Reed	263	Tenor Sax 2	TenoSax2
Reed	264	Baritone Sax	BariSax
Reed	265	Sweet Oboe	SwetOboe
Reed	266	Oboe 1	Oboe
Reed	267	English Horn 1	EngHorn
Reed	268	Bassoon 1	Bassoon
Reed	269	Clarinet 1	Clarinet
Reed	270	Clarinet 2	Clarinet2
Pipe	271	Piccolo	Piccolo
Pipe	272	Flute	Flute
Pipe	273	Sweet Flute	SweeFlut
Pipe	274	Recorder	Recorder
Pipe	275	Sweet Pan Flute	SwPanFu
Pipe	276	Pan Flute	PanFlute
Pipe	277	Blown Bottle	Bottle
Pipe	278	Shakuhachi	Shakhchi
Pipe	279	Whistle 1	Whistle
Pipe	280	Whistle 2	Whistle2
Pipe	281	Ocarina	Ocarina
Synth Lead	282	Lead 1 (square)	SquareLd
Synth Lead	283	Square	Square
Synth Lead	284	Lead 1b (sine)	SineLead
Synth Lead	285	Square Lead 1	SquarLd1
Synth Lead	286	Lead 1a (square 2)	SquarLd2
Synth Lead	287	Lead 2a (sawtooth 2)	SawLead2
Synth Lead	288	Lead 2d (sequenced analog)	SquAnaLd
Synth Lead	289	Lead 2 (sawtooth)	SawLead1
Synth Lead	290	Lead 2b (saw + pulse)	SawPlsLd
Synth Lead	291	Lead 2c (double sawtooth)	DubSawLd
Synth Lead	292	Lead 3 (calliope)	CalliopLd
Synth Lead	293	Lead 4 (chiff)	ChiffLd
Synth Lead	294	Lead 5 (charang)	CharanLd
Synth Lead	295	Lead 5a (wire lead)	WireLead
Synth Lead	296	Lead 6 (voice)	VoiceLd
Synth Lead	297	Lead 7 (fifths)	FifthsLd
Synth Lead	298	Lead 8 (bass + lead)	BassLead
Synth Lead	299	Lead 8a (soft wrl)	SftWrILd
Synth Pad	300	Pad 1 (new age)	NewAgePd
Synth Pad	301	New Year Pad	NewYrPd
Synth Pad	302	Pad 2 (warm)	WarmPad
Synth Pad	303	Pad 2a (sine pad)	SinePad
Synth Pad	304	Pad 3 (polysynth) 1	PolySyPd
Synth Pad	305	Pad 4 (choir)	ChoirPad
Synth Pad	306	Pad 4a (itopia)	ItopiaPd
Synth Pad	307	Pad 5 (bowed) 1	BowedPad

Classify	No.	Full english Name	English Abbr
Synth Pad	308	Pad 6 (metallic) 1	MetalPad
Synth Pad	309	Pad 7 (halo) 1	HaloPad
Synth Pad	310	Pad 8 (sweep) 1	SweepPad
Synth Pad	311	FX 1 (rain)	FXRain
Synth Pad	312	FX 2 (soundtrack)	Soundtrk
Synth Pad	313	FX 3a (synth mallet)	SynMalet
Synth Pad	314	FX 3 (crystal)	Crystal
Synth Pad	315	FX 4 (atmosphere)	Atmosphr
Synth Pad	316	Warm Air	WarmAir
Synth Pad	317	FX 5 (brightness)	Bright
Synth Pad	318	FX 6 (goblins)	Goblins
Synth Pad	319	FX 7 (echoes) 1	Echoes
Synth Pad	320	FX 7a (echo bell) 1	EchoBell
Synth Pad	321	FX 7b (echo pan)	EchoPan
Synth Pad	322	FX 8 (sci-fi)	Sci-Fi
Ethnic Misc.	323	Sitar 1	Sitar
Ethnic Misc.	324	Sitar 2 (bend)	Sitar2
Ethnic Misc.	325	Banjo	Banjo
Ethnic Misc.	326	Shamisen	Shamisen
Ethnic Misc.	327	Koto	Koto
Ethnic Misc.	328	Taisho Koto	TaishoKt
Ethnic Misc.	329	Kalimba	Kalimba
Ethnic Misc.	330	Bag Pipe	Bagpipe
Ethnic Misc.	331	Fiddle	Fiddle
Ethnic Misc.	332	Shanai	Shanai
Percussive	333	Tinkle Bell	TnklBell
Percussive	334	Steel Drums	SteelDrm
Percussive	335	Woodblock	WoodBlok
SFX	336	Seashore	Seashore
SFX	337	Thunder	Thunder
SFX	338	Telephone Ring 1	Telephone
SFX	339	Applause	Applause
Combined Voice	340	Stereo Piano & Strings Pad	StPn&Str
Combined Voice	341	Stereo Piano & Choir	StPn&Cho
Combined Voice	342	Stereo Piano & Synth Strings	StPn&Syn
Combined Voice	343	Stereo Piano & Warm Pad	StPn&Pad
Combined Voice	344	Rock Organ & Strings	RoOr&Str
Combined Voice	345	Steel Guitar & Warm Pad	StGt&Pad
Combined Voice	346	Orchestra	Orchest
Combined Voice	347	Full Strings 1	FullStr1
Combined Voice	348	Symphonic	Symphon
Chinese Instruments	349	GuZheng	GuZheng
Chinese Instruments	350	PiPa	PiPa
Chinese Instruments	351	ErHu 1	ErHu1
Chinese Instruments	352	Bandi	Bandi
Chinese Instruments	353	Hulusi	Hulusi
Chinese Instruments	354	LuSheng 1	LuShen1
Chinese Instruments	355	SuoNa	SuoNa
Chinese Instruments	356	PaiXiao	PaiXiao
Drum Set	357	Standard Set	StandSet
Drum Set	358	Room Set	RoomSet
Drum Set	359	Power Set	PowerSet
Drum Set	360	Jazz Set	JazzSet

Styles Liste

Classify	No.	Full english Name	English Abbr
8 BEAT	1	8Beat Piano	8BtPiano
8 BEAT	2	8Beat 1	8Beat1
8 BEAT	3	8Beat Shuffle	8BtShufl
8 BEAT	4	Guitar Pop 1	GtPop1
8 BEAT	5	8Beat Hip Hop	8BtHiHop
8 BEAT	6	8Beat R&B	8BeatR&B
8 BEAT	7	8Beat Pop	8BtPop
8 BEAT	8	Pop Funk 1	PopFunk1
8 BEAT	9	Rhythm & Beat 1	Rhy&Bt1
8 BEAT	10	8Beat Disco 1	8BtDisc1
8 BEAT	11	8Beat Rock	8BtRock
8 BEAT	12	8Beat 2	8Beat2
8 BEAT	13	Sweet Beat	SweetBt
8 BEAT	14	8Beat Dance	8BtDance
8 BEAT	15	8Beat 3	8Beat3
8 BEAT	16	60's 8Beat	60's8Bt
16 BEAT	17	16Beat 1	16Beat1
16 BEAT	18	16Beat Funk 1	16BtFuk1
16 BEAT	19	16Beat Ballad 1	16BtBld1
16 BEAT	20	16Beat R&B	16BtR&B
16 BEAT	21	Pop 16Beat 1	Pop16Bt1
16 BEAT	22	16Beat Dance	16BDanc
16 BEAT	23	16Beat 2	16Beat2
16 BEAT	24	Modern 16Beat	Modrn16B
16 BEAT	25	16Beat Hot	16BtHot
16 BEAT	26	16Beat Modern	16BModr
16 BEAT	27	16Beat 3	16Beat3
16 BEAT	28	Cool Beat	CoolBeat
16 BEAT	29	16Beat Ballad 2	16BtBld2
16 BEAT	30	16Beat 4	16Beat4
16 BEAT	31	Pop Shuffle	PopShufl
POP	32	Pop Rock 1	PopRock1
POP	33	Pop Dance 1	PopDanc1
POP	34	Pop Fusion	PopFusn
POP	35	Analog Night 1	AnalgNt1
POP	36	6/8 Pop	6/8Pop
POP	37	Brit. Pop 1	BritPop1
POP	38	Brit. Pop 2	BritPop2
POP	39	Pop Hit	PopHit
POP	40	Fusion Shuffle	FusShufl
POP	41	Pop Beat	PopBeat
POP	42	Soft Beat	SoftBeat
POP	43	60's Pop	60'sPop
POP	44	Sting Latin	StigLatn
BALLAD	45	R&B Ballad 1	R&BBad1
BALLAD	46	Guitar Ballad	GtBallad
BALLAD	47	Ballad Rock	BalladRk
BALLAD	48	Piano Pop	PianoPop
BALLAD	49	Soft Ballad	SoftBald
BALLAD	50	Natural Ballad	NatuBld
BALLAD	51	Love Ballad	LoveBld
BALLAD	52	Easy Ballad	EasyBld
BALLAD	53	Slow Ballad	SlowBald
BALLAD	54	Folk Ballad	FolkBld
BALLAD	55	Pop Ballad 1	PopBld1
BALLAD	56	EP Ballad	EPBallad
ROCK	57	Rock	Rock
ROCK	58	New Wave	NewWave
ROCK	59	Ska	Ska
ROCK	60	Slow Rock	SlowRock
ROCK	61	70's Rock & Roll	70'sRock
ROCK	62	Folk Rock	FolkRock

Classify	No.	Full english Name	English Abbr
ROCK	63	Soft Rock	SoftRock
ROCK	64	Easy Rock	EasyRock
ROCK	65	New Shuffle	NewShuffl
ROCK	66	Rock Hip Hop	RkHipHop
ROCK	67	Rock & Roll 1	R'N'R1
ROCK	68	Rock & Roll 2	R'N'R2
BALLROOM	69	Tango 1	Tango1
BALLROOM	70	Spain Matador	Matador
BALLROOM	71	Twist 1	Twist1
BALLROOM	72	Big Band Fox	BandFox
BALLROOM	73	Tango 2	Tango2
BALLROOM	74	Slow Fox	SlowFox
BALLROOM	75	Slow Waltz 1	SlowWlz1
BALLROOM	76	Swing Fox	SwingFox
BALLROOM	77	Salsa 1	Salsa1
BALLROOM	78	Cha Cha 1	ChaCha1
BALLROOM	79	Cha Cha 2	ChaCha2
BALLROOM	80	Beguine 1	Beguine1
BALLROOM	81	Beguine 2	Beguine2
BALLROOM	82	Rumba 1	Rumba1
BALLROOM	83	Samba 1	Samba1
BALLROOM	84	Jive	Jive
BALLROOM	85	Fox Trot	FoxTrot
DANCE	86	Techno 1	Techno1
DANCE	87	Hip Hop 1	HipHop1
DANCE	88	Dream Dance	DrnDance
DANCE	89	House	House
DANCE	90	Down Beat	DownBeat
DANCE	91	Progressive	Progress
DANCE	92	Rap 1	Rap1
DANCE	93	Disco	Disco
DANCE	94	Soft Disco	SoftDisc
DANCE	95	Disco Party	DscParty
DANCE	96	70's Disco	70'sDisc
DANCE	97	Club Dance	ClubDanc
DANCE	98	Euro Dance	EuroDanc
DANCE	99	Hip Hop 2	HipHop2
SOUL & FUNK	100	Funk 1	Funk1
SOUL & FUNK	101	Classic Funk	ClasFunk
SOUL & FUNK	102	Gospel Swing	GopSwing
SOUL & FUNK	103	Gospel	Gospel
SOUL & FUNK	104	Funk 2	Funk2
SOUL & FUNK	105	Electric Funk	ElecFunk
SOUL & FUNK	106	Groove Funk	GrooveFk
SOUL & FUNK	107	Cool Funky	ColFunky
SOUL & FUNK	108	Jazz Funk	JazzFunk
SOUL & FUNK	109	Groove	Groove
SOUL & FUNK	110	Soul	Soul
SOUL & FUNK	111	Hip Hop Beat	HipHopBt
SOUL & FUNK	112	R&B	R&B
SOUL & FUNK	113	Soul Beat	SoulBeat
SWING & JAZZ	114	Latin Jazz 1	LatinJz1
SWING & JAZZ	115	Big Band	BigBand
SWING & JAZZ	116	Dixieland 1	Dixland1
SWING & JAZZ	117	Broadway Big Band	BwayBand
SWING & JAZZ	118	Swing	Swing
SWING & JAZZ	119	Latin Jazz 2	LatinJz2
SWING & JAZZ	120	Fusion	Fusion
SWING & JAZZ	121	Acid Jazz	AcidJazz
SWING & JAZZ	122	Cool Jazz Ballad	CoolJzBd
SWING & JAZZ	123	Swing Shuffle	SwingSfl
SWING & JAZZ	124	Big Band Medium	BandMid

Classify	No.	Full english Name	English Abbr
COUNTRY	125	Country Pop 1	CntyPop1
COUNTRY	126	Bluegrass 1	Bluegrs1
COUNTRY	127	Country 8Beat	Ct8Beat
COUNTRY	128	Modern Country	ModernCt
COUNTRY	129	Country Pop 2	CntyPop2
COUNTRY	130	Bluegrass 2	Bluegrs2
COUNTRY	131	2/4 Country	2/4Cntry
COUNTRY	132	Country Quick Steps	QuickStp
COUNTRY	133	Country Folk	CntyFolk
COUNTRY	134	Country Shuffle	CnyShufl
Latin & Latin Dance	135	Bossa Nova	BosaNov
Latin & Latin Dance	136	Latin	Latin
Latin & Latin Dance	137	Tikitikita	Tikitkta
Latin & Latin Dance	138	Lambada	Lambada
Latin & Latin Dance	139	Pop Cha Cha 1	PChaCha1
Latin & Latin Dance	140	Pop Cha Cha 2	PChaCha2
Latin & Latin Dance	141	Salsa 2	Salsa2
Waltz & TRADITIONAL	142	Waltz	Waltz
Waltz & TRADITIONAL	143	Old Waltz	OldWaltz
Waltz & TRADITIONAL	144	English Waltz	EngWaltz
Waltz & TRADITIONAL	145	German Waltz	GemWaltz
Waltz & TRADITIONAL	146	ViennaWaltz	VinaWtz
Waltz & TRADITIONAL	147	Slow Waltz 2	SlwWltz2
Waltz & TRADITIONAL	148	Jazz Waltz	JzWaltz
Waltz & TRADITIONAL	149	Polka	Polka
Waltz & TRADITIONAL	150	March	March
CHINESE FOLK	151	Chinese R&B 1	ChnR&B1
CHINESE FOLK	152	GuangXi Folk	GuangXi
CHINESE FOLK	153	Chinese Folk 1	ChnFolk1
CHINESE FOLK	154	NeiMeng Folk	NeiMFolk
CHINESE FOLK	155	JiangNan Folk1	JangNan1
CHINESE FOLK	156	XinJiang Folk	XJangFok
CHINESE FOLK	157	YangGe	YangGe
CHINESE FOLK	158	YunNan	YunNan
CHINESE FOLK	159	Jubilance	Jubilanc
CHINESE FOLK	160	GuangDong	GungDong

Songlisten

Classify	No.	Full english Name	English Abbr
FOLK & COUNTRY	1	Jambalaya	Jambalay
FOLK & COUNTRY	2	Ding! Dong! Merrily On High	DingDong
FOLK & COUNTRY	3	Battle Hymne Of The Republic	Battle
FOLK & COUNTRY	4	The Old Gray Mare	GrayMare
FOLK & COUNTRY	5	American Patrol	USPatrol
FOLK & COUNTRY	6	Christmas Is Coming	IsComing
FOLK & COUNTRY	7	Sippin' Cider Through A Straw	SCTStraw
FOLK & COUNTRY	8	Christmas Sound	Sound
GOLDEN & POP	9	On London Bridge	LdBridge
GOLDEN & POP	10	Are You Lonesome Tonight	Lonesome
GOLDEN & POP	11	Der Deitcher's Dog	DerDDog
GOLDEN & POP	12	Joy To The World	JoyWorld
GOLDEN & POP	13	Silent Night	SttNight
GOLDEN & POP	14	Ave Maria	AveMaria
GOLDEN & POP	15	Five Hundred Miles	FHMiles
GOLDEN & POP	16	Happy New Year	HappyNY
GOLDEN & POP	17	It's Beginning To Look A Lot Like Christmas	LikeXmas
GOLDEN & POP	18	Jeanie With The Light Brown Hair	LightHair
GOLDEN & POP	19	My Bonnie	MyBonnie
GOLDEN & POP	20	Song Of The Pearlfisher	SongOfTP
CLASSICAL	21	Swan	Swan
CLASSICAL	22	Prelude To Act 2 (Swan Lake)	SwanLak1
CLASSICAL	23	Valse (Swan lake)	SwanLak2
CLASSICAL	24	The Happy Farmer	HpFarmer
CLASSICAL	25	The Sleeping Beauty	SleepBty
CLASSICAL	26	La Traviata	LaTravia
CLASSICAL	27	Wiegenlied	Wiegenli
CLASSICAL	28	Mov. 2 Adagio Non Troppo Piano Sonata No. 9 In D	Sonata9
CLASSICAL	29	Mov. 1 Andante Grazioso Piano Sonata No. 11 In A [Alla Tur Sonata 11 ca]	Sonata11
CLASSICAL	30	Prelude In C	Prelude
CLASSICAL	31	Chinese Dance	ChDance
CLASSICAL	32	Emperors Waltz	EmprWaltz
CLASSICAL	33	March Militaire	MilMar1
CLASSICAL	34	Symphony No. 40	Symphony
JAZZ & FUSION	35	ShanZhaShu	ShanZhaS
JAZZ & FUSION	36	You Are My Sunshine	MySun
JAZZ & FUSION	37	June Samba	JunSamba
JAZZ & FUSION	38	Funk	Funk
JAZZ & FUSION	39	I Can.....	I Can...
JAZZ & FUSION	40	Sea Shore	SeaShore

Classify	No.	Full english Name	English Abbr
JAZZ & FUSION	41	Guitar & Saxphone	Gt&Sax
JAZZ & FUSION	42	The Hip Hop's Night	HipHopNt
JAZZ & FUSION	43	Blue Lunch	BlueLunch
JAZZ & FUSION	44	Cobweb	Cobweb
JAZZ & FUSION	45	Wine	Wine
JAZZ & FUSION	46	Jazz Old Man	JzOldMan
JAZZ & FUSION	47	Dark Eyes	DarkEyes
JAZZ & FUSION	48	Carlos	Carlos
JAZZ & FUSION	49	Sad	Sad
JAZZ & FUSION	50	The Jazz	TheJazz
PIANO	51	Fur Elise	FurElise
PIANO	52	Military March	Mmarch
PIANO	53	Habanera	Habanera
PIANO	54	Minuet	Minuet
PIANO	55	Austria Variation	Avariati
PIANO	56	Old Macdonald Had A Farm	OldAFarm
PIANO	57	Wedding March	Wedding
PIANO	58	2-Part Invention #13 In A Minor.B.W. lli	Invention
PIANO	59	Minuet In G	MinuetG
PIANO	60	Turkish March	TurkishM
PIANO	61	Hey Diddle Diddle	HeDiddle
PIANO	62	Italian Polka	ItaPolka
PIANO	63	Moseta Dance	MosetaDn
PIANO	64	Bulie Dance	BulieDn
PIANO	65	Waltz in A Flat Op.39 No.15	Waltz 1
PIANO	66	Wild Rose	WildRose
PIANO	67	Away In A Manger	AwayInAM
PIANO	68	Jack & Jill	JackJill
PIANO	69	Angles We Have Heard On High	Angles
PIANO	70	Waltz	Waltz
PIANO	71	Did You Ever See A Lassie	Lassie
PIANO	72	Chopsticks	Chopstick
PIANO	73	Four Little Swans	FLSwans
PIANO	74	Old France	OldFrance
PIANO	75	Jesus Saviour Pilot Me	PilotMe
PIANO	76	Eclogue	Eclogue
PIANO	77	Santa Claus Is Coming To Town	SantaCT
PIANO	78	Brave Cavalier	Cavalier
PIANO	79	America The Beautiful	USFair
PIANO	80	Music Box Dancer	Dancer

Spezifikationen

Produkt	Funkey DP-88 II Digitalpiano (00056961 schwarz; 00056964 weiß; 00056965 braun)
Tastatur	88 Tasten (Standard),
Anschlagempfindlichkeit	ja
Max. Polyphonie	128 Noten
Sounds	360 Arten von Stimmen
Style	160 verschiedene Styles
Demo	80 Demolieder
Effekte	Touch, Reverb, Chorus, Dual, Split, Function Menü, Sound console
Aufnahme	Singletrack, Multitracks kombinierte Aufnahme
Begleitende Steuerungen	Lautstärke Volumen, Transponieren, MP3-Funktion
Begleitautomatik	A.B.C Auto Chord, Keyboard Chord
Pedal	Soft Pedal, Sostenuto Pedal, Sustain Pedal
Anschlüsse	Netzteilanschluss, USB(MP3) Anschluss, Output, Sustain Pedal, MIDI IN/OUT Anschluss, USB(MIDI) Anschluss
Lautsprecher	2 x 15W Stereo
Stromversorgung	DC IN 12V – 15V, 2A-3A
Gewicht	29,40kg

WEEE-Erklärung / Entsorgung



Ihr Produkt wurde mit hochwertigen Materialien und Komponenten entworfen und hergestellt, die recycelbar sind und wiederverwendet werden können. Dieses Symbol bedeutet, dass elektrische und elektronische Geräte am Ende ihrer Nutzungsdauer vom Hausmüll getrennt entsorgt werden müssen. Bitte entsorgen Sie dieses Gerät bei Ihrer örtlichen kommunalen Sammelstelle oder im Recycling Center. Bitte helfen Sie mit, die Umwelt, in der wir leben, zu erhalten.

Technische Änderungen und Änderungen im Erscheinungsbild vorbehalten. Alle Angaben entsprechen dem Stand bei Drucklegung. Für die Richtigkeit und Vollständigkeit der enthaltenen Beschreibungen, Abbildungen und Angaben übernimmt Musikhaus Kirstein GmbH keinerlei Gewähr. Abgebildete Farben und Spezifikationen können geringfügig vom Produkt abweichen. Musikhaus Kirstein GmbH - Produkte sind nur über autorisierte Händler erhältlich. Distributoren und Händler sind keine Handlungsbevollmächtigten von Musikhaus Kirstein GmbH und haben keinerlei Befugnis, die Musikhaus Kirstein GmbH in irgendeiner Weise, sei es ausdrücklich oder durch schlüssiges Handeln, rechtlich zu binden. Diese Bedienungsanleitung ist urheberrechtlich geschützt. Jede Vervielfältigung, bzw. jeder Nachdruck, auch auszugsweise, und jede Wiedergabe der Abbildungen, auch in verändertem Zustand, ist nur mit schriftlicher Zustimmung der Firma Musikhaus Kirstein GmbH gestattet.

Herstellerangaben

Musikhaus Kirstein GmbH

Bernbeurener Strasse 11

86956 Schongau

Telefon: 0049-8861-909494-0

Telefax: 0049-8861-909494-19

www.kirstein.de

 **KIRSTEIN.de**

English User manual

Precautions / Please read carefully before proceeding

Always follow the basic precautions listed below to avoid the possibility of serious injury or even death from electrical shock, short-circuiting, damages, fire or other hazards.

Power supply / power cord (devices with power cords/power supplies):

Only use the voltage specified as correct for the device. The required voltage is printed on the type plate of the device. Check the power cable from time to time regarding dirt, damage or other influence. Use only the included power cord / power supply or adaptor. Do not place the power chord near heat sources such as heaters or radiators, and do not excessively bend or otherwise damage the cord, place heavy objects on it, or place it in a position where anyone could walk on, trip over, or roll anything over it. Remove the electric plug from the outlet when the device is not to be used for extended periods of time, or during electrical storms. When removing the electric plug from the device or an outlet, always hold the plug itself and not the cord. Pulling by the cord can damage it. To avoid generating unwanted noise, make sure there is adequate distance (50 cm or more) between the AC power adaptor and the device. Do not cover or wrap the AC power adaptor with a cloth or blanket.

Location:

When setting up the device, make sure that the AC outlet you are using is easily accessible. If some trouble or malfunction occurs, immediately turn off the power switch and disconnect the plug from the outlet. Even when the power switch is turned off, electricity is still flowing to the product all the minimum level. When you are not using the product for a long time, make sure to unplug the power cord from the wall AC outlet. Inadequate ventilation can result in overheating, possibly causing damage to the device(s), or even fire Do not expose the device to excessive dust or vibrations, or extreme cold or heat (such as in direct sunlight, near a heater, or in a car during the day) to prevent the possibility of panel disfiguration or damage to the internal components. Do not place the device in an unstable position where it might accidentally fall over. Do not block the vents. This device has ventilation holes at the bottom/rear to prevent the internal temperature from becoming too high. In particular, do not place the device on its side or upside down. Inadequate ventilation can result in overheating, possibly causing damage to the device(s), or even fire. Do not use the device in the vicinity of a TV, radio, stereo equipment, mobile phone, or other electric devices. Doing so may result in noise, both in the device itself and in the TV or radio next to it.

Connections and handling:

Before connecting the device to other devices, turn off the power for all devices. Before turning the power on or off for all devices, set all volume levels to minimum. Do not use the device or headphones for a long period of time at a high or uncomfortable volume level, since this can cause permanent hearing loss. If you experience any hearing loss or ringing in the ears, consult a physician. Do not rest your weight on the device or place heavy objects on it, and avoid use excessive force on the buttons, switches or connectors. Do not open the device or attempt to disassemble the internal parts or modify them in any way. The device contains no parts where the user can do service. If it should appear to be malfunctioning, discontinue use immediately and have it inspected by qualified service personnel.

Table of Contents

Panel Control&Display Illustration.....	1
Left Panel.....	1
LCD Display.....	2
Right Panel.....	2
Rear Panel.....	3
Assembly.....	4
The preparation before performance.....	6
Power supply.....	6
Connect Headphone.....	6
Connect Audio Equipment.....	6
Connect computer.....	6
Connect other equipments.....	7
Connect Pedal.....	7
Connect audio equipments.....	7
Connect USB Equipment.....	7
Power Switch.....	8
Adjust Master Volume.....	8
Play voice of various kinds of instruments.....	8
Choose and play voice(Master voice).....	8
Play two kinds of voice(Dual voice).....	8
Touch response.....	9
Transpose.....	9
The mode of piano performance.....	9
Metronome.....	10
Play various kinds of style of accompaniments.....	10
Play auto accompaniment(Play only the voice part of percussion music).....	10
Accompaniment Paragraph.....	10
Play different accompaniment paragraphes.....	11
Accompaniment volume control.....	11
Tempo.....	12
Auto chord.....	12
Full range Chord.....	12
Chord close.....	12
Chord list.....	12
Reverb.....	13
Chorus.....	13
Sound console.....	13
Function menu.....	14
Tune setting.....	14
Keyboard split setting.....	14
Beat type setting.....	15
Metronome volume setting.....	15
Reverb depth setting.....	15
Chorus depth setting.....	15
MIDI receiving setting.....	15
MIDI sending setting.....	15
Factory reset.....	16
Panel registration memory setting.....	16

Store setting into Registration memory.....	16
Tune out registration memory.....	16
Choose memory bank.....	16
Record your own songs.....	17
Start record.....	17
Stop record.....	18
Replay recorded songs.....	18
Delete recorded songs.....	18
Play and control song.....	18
Appreciate songs.....	18
Song control.....	19
Songs learning mode.....	19
MP3 play.....	20
Voice list	21
Style list	27
Songs list	30
Technical Specifications.....	32

Panel control and display illustration

Left Panel



1. **【Master volume】** button
Adjust volume size
2. **【Tempo \downarrow/\uparrow 】** button
Adjust present tempo
3. **【Accompaniment volume \downarrow/\uparrow 】** button
Adjust accompaniment volume
4. **【Auto chord】** button
5. **【Full range chord】** button
6. **【Chord close】** button
7. **【Split】** button
8. **【Touch】** button
Choose keyboard touch curve
9. **【Function menu】** button
Enter into function menu

In the song mode:

10. **【 ↺ 】** Button
Set the beginning and ending position of song paragraph loop
11. **【 || 】** Button
Pause to play or continue to play the songs
12. **【 ⏮ 】** Button
To play songs fast backward
13. **【 ⏭ 】** Button
To play songs fast forward
14. **【 ▶/■ 】** Button
Start or stop to play the songs

In style mode:

10. **【Intro/Ending】** button
Play the intro/ending of auto accompaniment
11. **【Sync】** button
Open/Close sync function
12. **【FILL IN1】** button
Fill in variation1
13. **【FILL IN2】** button
Fill in variation2
14. **【Start/Stop】** button
Start or stop to play accompaniment
15. **【Rec】** button
Start the record function
16. **【Track1】** button
Choose track 1 in record
17. **【Track2】** button
Choose Track 2 in record
18. **【Track3】** button
Choose Track 3 in record
19. **【Metronome】** button
Open or Close metronome
20. **【Transpose \downarrow/\uparrow 】** button
21. **【Sound console】** button
Enter into sound console menu
22. LCD display screen
Display all important setting information about this equipment

LCD display

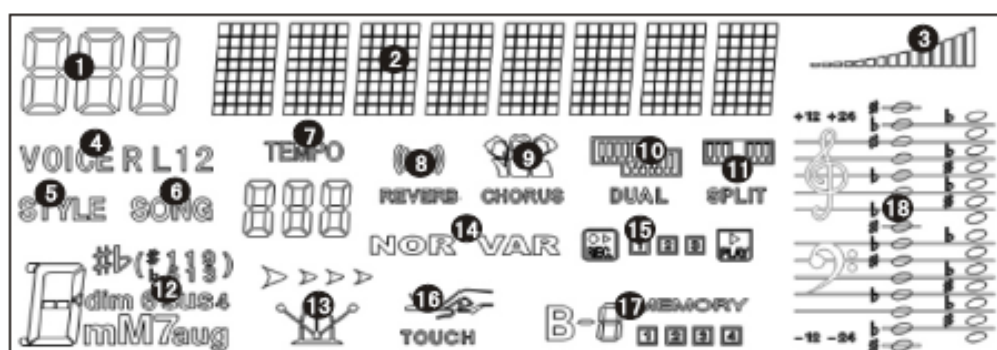

- | | | |
|------------------------------|------------------------|------------------------|
| 1. Digital code display area | 7. Tempo | 13. Metronome |
| 2. Characters display area | 8. Reverb | 14. FILL IN1/FILL IN2 |
| 3. Volume | 9. Chorus | 15. Record/Play |
| 4. Voice selection | 10. Dual voice | 16. Touch |
| 5. Style selection | 11. Keyboard split | 17. State memory |
| 6. Songs | 12. Chord display area | 18. Staff display area |

Right Panel



- | | |
|--|---|
| 23. [Piano] button
Open or close piano performance mode | 32. [Song] button
Switch to song function state |
| 24. [Style] button
Switch to style function state | 33. [Lesson] button
Enter into learning mode |
| 25. [Voice] button
Switch to voice function state | 34. [Left] button
Choose left hand voice part of learning songs |
| 26. [Number/+, -] button
Adjust parameters | 35. [Right] button
Choose right hand voice part of learning songs |
| 27. [Dual] button
Open or close dual voice function | 36. [Store] button |
| 28. [Reverb] button | 37. [M1] button
To tune out panel setting1 promptly |
| 29. [Chorus] button | 38. [M2] button
To tune out panel setting2 promptly |
| 30. [Song\wedge/Volume\vee]
Switch to previous song MP3
Press this button longer time to reduce MP3 play volume | 39. [Bank] button
Switch memory bank |
| 31. [Song\vee/Volume\wedge]
Switch to next song MP3
Press this button longer time to increase MP3 play volume | 40. [Play/Pause] button
Play/ Pause MP3, |
| | 41. [Power] button
Open/Close power |

Rear Panel

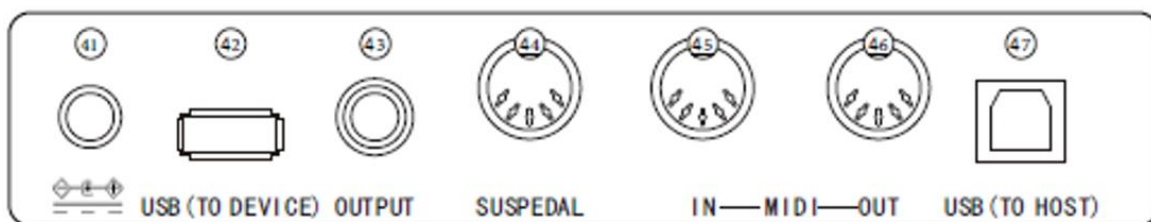

39.External power jack

Connect to external power adaptor

40.USB(MP3) equipment jack

Connect USB equipment

41.Audio out jack

Connect to external audio equipment

42.Pedal input jack

Connect to pedal

43.MIDI IN jack

Receiving MIDI information that was sent out by external MIDI equipment or computer







44.MIDI OUT jack

Sending data of this piano to computer or MIDI equipment by this jack

45.USB(MIDI) jack

The headphone jack is located as a single 6,3mm jack on the left side of the bottom plate of the piano.

Assembly parts

①		TA4*12Schrauben	12stk
②		M6*50Schrauben	12stk
③		M6*20Schrauben	4stk
④		Hammermuttern	8stk
⑤		Winkelverbinder	
⑥		Plastikabdeckung für M6 Schrauben	

Piano body assembly

1. Using 12 pcs of TA4*12 screws to fix 4 pcs of corner connectors of piano brackets to left & right boards separately.
2. Pressing 8 pcs of hammer cuts into the corresponding holes of left & right boards and connection board separately.
3. Using 4 pcs of M6*50 screws to connect left & right boards with left & right ground feet.
4. Using 4 pcs of M6*50 screws to connect left & right boards and connection board crossing 4 pcs of plastic cap of M6 screw separately, then cover this cap.
5. Using 4 pcs of M6*50 screws to connect left & right boards and pedal group parts crossing 4 pcs plastic cap of M6 screws separately, then cover this cap.
6. Put piano body to piano bracket, then, using 4 pcs of M6*20 screws to fix piano body to piano bracket.
7. Inserting another end of pedal connection line into pedal jack of rear plastic function jack.

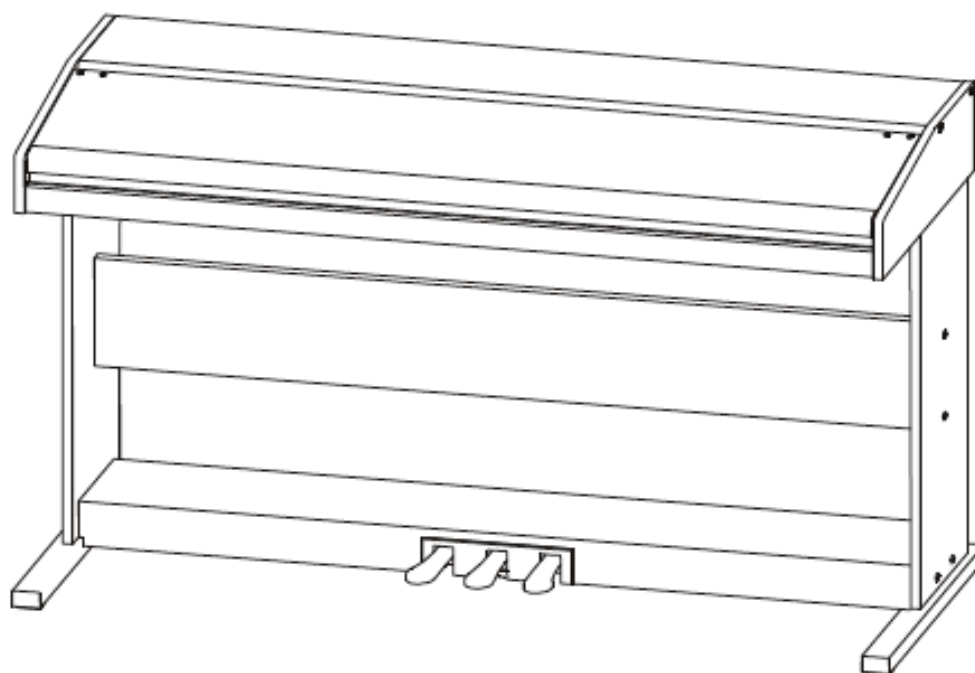

Assembly diagram

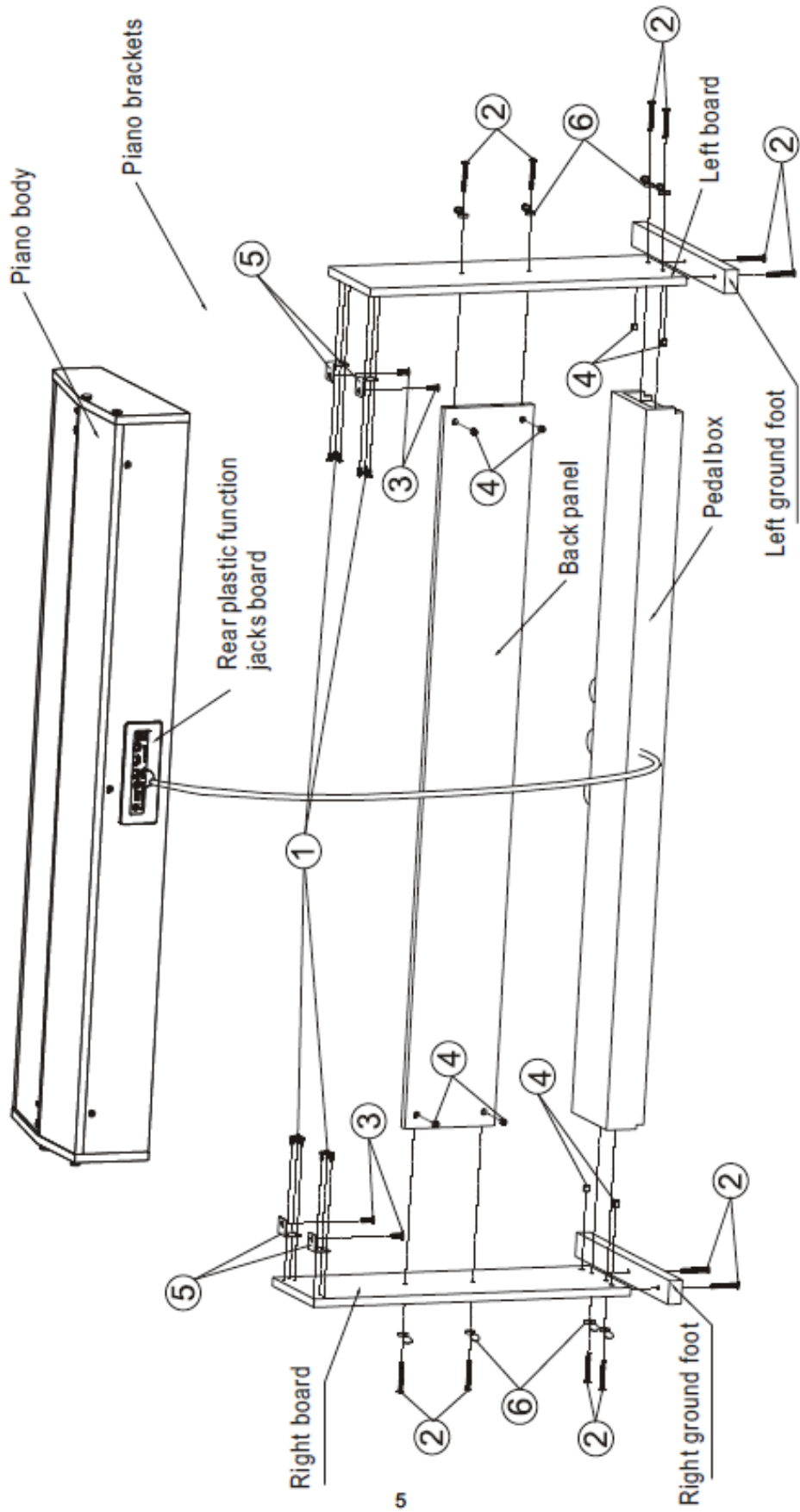

Preparation before performance

Power supply

1. Please make sure that this instrument is at off state before connecting power.
2. Connect power adaptor to the DC jack of this instrument.
3. Insert plugs of power adaptor into AC power socket.
4. Pressing down [power] button, LCD screen displays "Loading." Indicating that this piano has been opened.

Notice:

For safety purpose, please cut off the power of this instrument when you don't use it or suffer thunderstorm weather.



Connect headphone

You can insert stereo headphone into phone jack of this piano when you need exercise alone or play it late at night. The speakers of this instrument will cut off automatically after headphone was entered into phone jack, the sound can only be heard from headphone, You can play as much as you can, you aren't afraid to disturb others.

Notice:

Please avoid using headphone for long time high volume, or else, it will cause human ear fatigue, moreover, hearing damage.

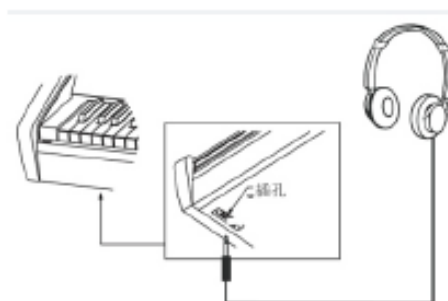

Connect audio equipment

Connecting this piano with external acoustics equipments, better music effect can be got. The audio out jack in rear panel can be used to connect to keyboard volume amplifier, Stereo acoustics systems, Sound console, Recorder or other equipments Using audio line to connect audio equipment to audio out jack of rear panel, Connecting another end to audio input jack of other equipments.

Notice:

Before connecting other equipments, please make sure that the power of all equipments had been closed, moreover, please make sure that volume setting of every parts had been adjusted to lowest value before opening power of equipments at the same time.

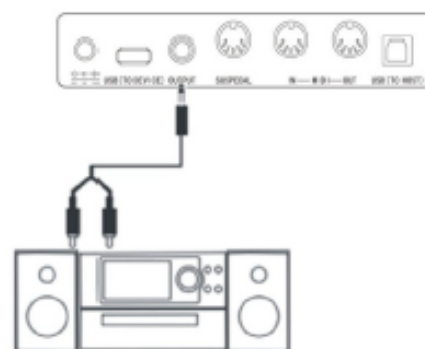

Connect computer

This piano supplies one USB jack, it can be connected to personal computer. You only need one USB line, one end was inserted into USB jack of this piano, other end was inserted into USB port of computer, it can transfer information with computer in both direction. Such as you can store the music that you had played on this piano to the computer, you also can play MIDI document of your computer by this piano as well.

Notice:

The USB audio equipment can't be setted for input and output at the same time when you do the setting of the computer software, or else the sound will be overlapping when you play the keys.



Connect to other equipments

Connecting MIDI IN of this instrument to MIDI OUT of other equipments, you can use this instrument as sound source.

Connecting MIDI OUT of this instrument to MIDI IN of other equipments, you can use this instrument as MIDI controller.

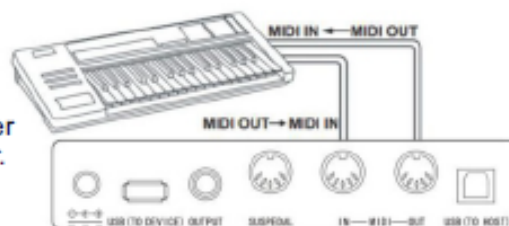

Connect Pedal

Three pedals group parts was connected to SUSPEDAL jack of rear panel of piano, then, this piano can own three different function pedal: Soft Pedal, Sostenuto Pedal, Sustain Pedal

1. Soft Pedal:

The soft pedal was stepped on, the played notes will occur pianissimo effect.

2. Sostenuto Pedal:

After this Sostenuto Pedal was stepped on, the playing notes will occur sustain effect before this pedal was stepped on.

3. Sustain Pedal:

The sustain pedal was stepped on, the played notes will occur sustain effect.

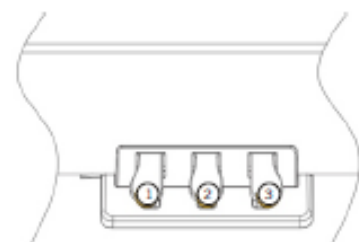

1. Soft Pedal 2. Sostenuto Pedal 3. Sustain Pedal

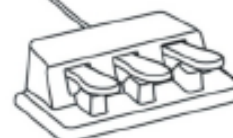

Connect USB equipment

The piano support to connect largest 32G USB equipment, such as U plate etc, The MP3 files in USB equipment can be played.

Notice:

Don't not pull out USB equipment in playing process, or else it will cause mistake or USB equipment damage.

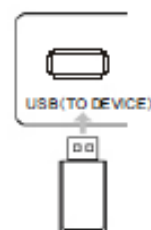

Power Switch

1. Firstly, Please make sure that the power had been connected correctly.

2. Press down **【Power】** button, LCD display screen will become lighter, Displaying boot screen, indicating that the piano had been opened.

Notice:

The LCD screen hasn't been lighted if you had press down **【Power】** button, please check that whether the power was connected correctly.



Adjust volume

To rotate **【Master Volume】** knob to the right after the piano was opened, the overall volume will become larger from smaller, to rotate **【Master Volume】** knob to the left, the overall volume will become smaller from larger. You can adjust the volume based on your requirement.



Play various kinds of instruments voice

This piano has built-in hundreds kinds of vivid voice, including the timbre of chinese folk music, percussion tone etc.

The detailed information, please see voice list. We also supply the effect function that it is relative to voice for your better playing voice

Choose and play voice(Master voice)

1. Pressing **【Tone】** button, The voice selection mode can be entered into, the reminding mark "R1" lights in LCD at the same time, moreover, the present voice name and no. display as well.

2. Using number button and **【+】/【-】** button to choose the voice that you need.

3. To play keys to start play and appreciate wonderful voice.

Notice:

To change voice selection sourcing you can press **【Voice】** button again and again if you had opened dual voice function. The corresponding R1/R2/L cursor will switch to light to display in LCD display screen.



Play two kinds of voice (Dual voice)

This piano has dual voice function, The casual two kinds of voice can be superposed and sounded at the same time by this function, The new voice effect will occur to enrich the layers of music. it seems that two kinds of instruments play at the same time. The voice will be first "R1" voice before the dual voice function was started, The choosed voice will be second "R2" after dual voice function had been started.

1. Pressing **【Dual voice】** button to open dual voice function, The "R2" mark lights in LCD, the present dual voice name and No. Display as well at the same time.

2. To choose the dual voice that you want to play by number buttons and **【+】/【-】** buttons.

3. The voice effect that was superposed by two kinds of different voices can be heard when you play the keyboard, it seems that two kinds of instruments are playing at the same time.

4. Press **【Dual voice】** button again, the dual voice effect can be closed, "R2" cursor goes out in LCD, LCD display screen recovers previous state.

Notice:

1. When the music range of keyboard was divided, Only the keyboard in right hand area has dual voice function, the keyboard in left hand area doesn't have this function



Touch Response

The keyboard of this piano has touch response function, It can help to enrich performance expression. It can reflect the touch that you had used to every notes correctly, It seems that you are playing real instrument. This piano has three pcs touch curves for choosing.

1. Press **【Touch】** button to enter into touch function choosing state. The touch curve no. of present keyboard displays in LCD screen temporarily, The default touch curve is second one in Boot-Up State, there are three pcs touch curves in total (001-003).

2. Choose touch curve

In the state of touch curve that displays in LCD screen temporarily, you can choose different touch curves by press **【Touch】** button continuously.

3. Close touch response

The present touch displays "OFF" in LCD, The relative "Touch" state mark goes out in LCD, it indicates that present keyboard is without touch response state.



Transpose

To use transpose function, you don't need to change play way, you can adjust the pitch of full keyboard in the unit of semitone.

1. Press down **【Transpose v】** or **【Transpose ^】** button to enter into transpose setting state, The present transpose value "xxx Transpos" displays in LCD temporarily.

2. Adjust tranpose value

When tranpose value "xxx Transpos" displays in LCD screen temporarily, you can press **【Transpose ^/v】** button continuously to adjust keyboard pitch, the largest adjusting scope is ± 12 pcs seminote.

3. The transpose value will recover to default "000 Transpos" if you press down **【Transpose ^/v】** button at the same time.

Reminder:

If you want to play one G tone music, but you aren't familiar with G tone keyboard, you can set transpose parameter for -05 or 007 at this time, you can use C tone pitch to play to produce G tone real pitch at this time, This parameter adjustment is valid for full keyboard and auto chord accompaniment.



Piano performance mode

This piano designs this function specially, you can tune out piano tone of full keyboard promptly in other state.

1. Pressing **【Piano】** button, the piano performance mode can be entered into or exited directly.

2. Choosing and starting style in piano performance mode, The accompaniment control can be operated same other mode, but style only play percussion music part, there is no harmony accompaniment part.

Notice:

1. The sound console function and function menu can be entered into in piano performance mode.

2. The chord function will be closed automatically after the piano performance mode was entered into.



Metronome

If you are afraid that you are't sure about beat when you are practicing music or recording,you can get special metronome reminder by metronome function.

1.Open Metronome

Pressing **【Metronome】** button to open metronome function, beat sounds,Pressing **【Metronome】** button again to close metronome function.

2.Metronome style setting

Please jump to beat type setting in funtion menu to see setting method.

Notice:

- 1.If the metronome was opened in style playing process,the beat sound will be responded to at the beginning of next beat, the beat point will change followed styles.
- 2.If the metronome was opened fistly,then,play style,this piano will adjust metronome automatically at the same time that the first beat of style sounded to make it match with styles.
- 3.The metronome can be opened in recording,but the sound of metronome wasn't stored as recorded data.



METRONOME



Playing various kinds of style accompaniments

Using auto accompaniment function,you play piano alone and you can enjoy the accompaniment effect of whole band,moreover, the Orchestra,you only need to start the different styles of accompaniment that you had choosed and use left hand to play suitable chord,the music will go ahead all the time.

This instrument has built in various kinds of auto accompaniment (The detailed information,please see style appendix list),you can choose your favorite accompaniment style and enjoy the pleasure that accompaniments bring to you as much as you can.

Play auto accompaniment

(Only play percussion music voice part)

1.Pressing **【Style】**button to enter into style mode, The top-left "STYLE"reminder marking lights in LCD and displays present style name and seria no.at the same time.

2.Choose style

You can choose the styles you need by number buttons or **【+】/【-】**buttons.

3.Start style

The percussion music part of style can be played immediatly by pressing **【Start/Stop】**button,you also can press**【Sync】**button to make the style to be in sync state.The beat point shines in LCD at the same time, then,play any keys to start style perucussion music performance.



STYLE



Accompaniment Paragraphs

The auto accompaniment itself of this piano contains many kinds of different accompaniment paragraphs,it is convenient that you arrange your own accompaniments in various kinds of ways.These paragraphs including:Main play(A , B). FILL IN(1 , 2). Intro. Ending.When you play accompaniment,you can make more professional performance effect easily by simple switch of these paragraphs.

1. Intro part

Intro is suitable for the beginning of one music, when the intro was played over, the accompaniment will enter into preset main play part. The length of intro will be different based on the difference of choosed style type.

2. Main play part

Main play is suitable to the main part of one song, the main play will loop play all the time before you had pressed other style control button.

3. FILL IN PART

It can produce various kinds of rich change for songs by FILLING IN paragraph 1 or 2, It enables your performance to be more professional. The accompaniment will switch to relative main play part automatically when FILL IN paragraphes had been played over.

4. Ending sound part

Ending sound is suitable to the ending of one song, The song will stop immediately when the ending sound was played over, the length of ending is relative to choosed styles.

Notice:

1. Holding one of **[FILL IN1]**、**[FILL IN2]** button when the accompaniment are going on, the variation will be loop filled in ,untill releasing this button to enter into relative main play part.

2. Pressing FILL IN button will change initial default main play paragraph in the state that the accompaniment has stopped, LCD display screen will display relative marking.

Play different accompaniment paragraphes

1. Pressing **[STYLE]** button, the styles can be choosed by pressing **[+]**/**[-]** button, numbers buttons at this time.

2. Pressing **[AUTO CHORD]** button to enter into auto bass chord mode.

3. Pressing **[SYNC]** button to open sync start function.

4. Pressing **[FILL IN 1]** to choose main play 1.

5. Pressing **[INTRO/ENDING]** button, FILL IN -"NOR" marking continue to shine in LCD, the style is in play preparation state at this time.

6. The auto accompaniment will start immediately when you pressed one chord in left hand area of keyboard.

The accompaniment will switch to relative main play part when intro part was played over.

7. Pressing **[FILL IN 2]** button, one small paragraph of variation will be filled in the accompaniment that are playing at this time. The accompaniment will switch to relative main play 2 automatically when the variation was played over.

8. Pressing **[INTRO/ENDING]** button, the accompaniment will enter into ending part at this time, the auto accompaniment will be stopped when the ending was played over.



STYLE



Accompaniment volume control

The accompaniment volume is used for adjusting the overall volume of auto accompaniment. This function can get balance between auto accompaniment part and the volume of keyboard tone.

1. Pressing **[ACCOMPANIMENT VOLUME∇]**/**[ACCOMPANIMENT VOLUME∧]** button, LCD display screen will displays present accompaniment volume size temporarily, the accompaniment volume size can be adjusted by pressing **[ACCOMPANIMENT VOLUME∇]**/**[ACCOMPANIMENT VOLUME∧]** again at this time. Adjustment range: 0~127

2. Pressing **[ACCOMPANIMENT VOLUME∇]** and **[ACCOMPANIMENT VOLUME∧]** buttons at the same time, the accompaniment volume can be closed. LCD display screen displays "Accompaniment volume : OFF". The accompaniment volume can be opened by pressing **[ACCOMPANIMENT VOLUME∇]** and **[ACCOMPANIMENT VOLUME∧]** buttons again at the same time.



Tempo

Every style has different best tempo value, you can change tempo value based on your hobby and songs requirement.

1. The initial default tempo value can be changed by **【Tempo v】** / **【Tempo ^】** button.
2. The tempo can recover initial default value by pressing **【Tempo v】** / **【Tempo ^】** buttons at the same time.

Notice:

The tempo will be setted for the preset value of present style automatically if you choose style when the styles stopped, The tempo will keep same if you switch style when the style are playing.



Auto chord

Pressing **【Auto Chord】** button to start auto accompaniment, The left hand will be automatic chord area at this time

Full rang chord

Pressing **【FULL RANGE CHORD】** button, all keyboard can be played chord sound at this time



Chord close

Pressing **【CHORD CLOSE】** button, the chord accompaniment sound stops, the style continue to play.

Chord list

Original name	Abbr.	Normal pronunciation
MAJOR	M	1-3-5
MAJOR SIXTH	M6	1-3-5-6
MAJOR SEVENTH	M7	1-3-(5)-7
MAJOR SEVENTH SHARP ELEVENTH	M7#11	1-(2)3#4-(5)-7
MAJOR ADD NINTH	Madd9	1-2-3-5
MAJOR NINTH	M9	1-2-3-(5)-7
MAJOR SIXTH ADD NINTH	69	1-2-3-(5)-6
AUGMENTED	aug	1-3-#5
MINOR	m	1 ^b 3-5
MINOR SIXTH	m6	1 ^b 3-5-6
MINOR SEVENTH	m7	1- ^b 3-(5)-7
MINOR SEVENTH FLATTED FIFTH	m7 ^b 5	1-3-5-7
MINOR ADD NINTH	madd9	1-2-3-5
MINOR ADD NINTH	m9	1-2-3-5
MINOR MAJOR ELEVENTH	m11	1-3-(5)-7
MINOR MAJOR SEVENTH	mM7	1- ^b 3-(5)-7
MINOR MAJOR NINTH	mM9	1-2-3-(5)-7
DIMINISHED	dim	1-3-5
DIMINISHED SEVENTH	dim7	1-3-5-6
SEVENTH	7	1-3(5)-7
SEVENTH SUSLEND FOURTH	7sus4	1-4-5-7
SEVENTH NINTH	79	1-2-3-(5)-7
SEVENTH SHARP ELEVENTH	7#11	1-(2)3-#4-(5)-b7
SEVENTH THIRTEENTH	713	1-3-(5)-7 / 2-3-5-6-7

Chord list

Original name	Abbr.	Normal pronunciation
SEVENTH FLATTED NINTH	7 ^b 9	1-2-3-(5)-7
SEVENTH FLATTED THIRTEENTH	7 ^b 13	1-3-5-6-7
SEVENTH SHARP NINTH	7 [#] 9	(1)- [#] 2-3-(5)-7
MAJOR SEVENTH AUGMENTED	M7 ^{aug}	1-3 [#] -5-7
SEVENTH AUGMENTED	7 ^{aug}	(1)-3- [#] 5-7
SUSPENED FOURTH	sus4	1-4-5
ONE PLUS TWO PLUS FIVE	1+2+5	1-2-5

Reverb

Pressing **【REVERB】** button, the reverb effect can be opened or closed.

The reverb effect was opened, the reverb cursor will light.
The reverb effect was closed, the reverb cursor will go out.



REVERB



REVERB

Chorus

Pressing **【CHORUS】** button, the chorus effect can be opened or closed.

The chorus effect was opened, the chorus cursor will light.
The chorus effect was closed, the chorus cursor will go out.



CHORUS



CHORUS

Sound console

The played volume of every tracks can be controlled solely by sound console function.

- Pressing **【SOUND CONSOLE】** button to enter into sound console function menu, LCD will display corresponding value temporarily. The first time to enter into the sound console menu when the power is on, The first option is "Percussion music track volume" of sound console menu, The option that was entered into again later is same as the option that exited from last time.
- Pressing **【SOUND CONSOLE】** button again and again to choose the track item that you want to do the setting, then, pressing **【-】 / 【+】** buttons to set parameters.

Concrete function items and parameters range are as following list:

Adjustment content	LCD display	Adjustment range
Percussion music track volume	XXX Rhythm	0 - 127
Bass track volume	XXX Bass	0 - 127
Hamony track volume	XXX Chord	0 - 127
Phrase track volume	XXX Phrase	0 - 127
left hand track volume	XXX Lower	0 - 127
Right hand track volume	XXX Upper	0 - 127

Notice:

If there is no any setting operation in 5 seconds in sound console setting state, the sound console function state will exit automatically.



SOUND CONSOLE

Function menu

Pressing【FUNCTION MENU】button to enter into function menu, LCD displays present function menu option temporarily, to set the parameters of present menu by pressing 【-】 / 【+】 buttons.



FUNCTION MENU

Concrete function items and parameters range are as following list:

Serial no.	Adjustment content	LCD Display	Adjustment range	Presetting value
1	Tune	XXX Tune	-50 ~ +50	000
2	Keyboard split	XXX KeySplit	1 ~ 88	034
3	Beat type	XXX BeatType	0, 2 ~ 9	004
4	Metronome volume	XXX MetroVol	0~127	080
5	Reverb depth	XXX Revb Lev	0~127	050
6	Chorus depth	XXX Chor Lev	0~127	000
7	MIDI Receiving	XXX Midi In	1 ~ 16, ALL	ALL
8	MIDI Sending	XXX Midi Out	1 ~ 16	001

Notice:

If there is no any setting operation in 5 seconds in function menu setting state, the function menu state will exit automatically.

Tune setting

This function is used to adjust pitch detailedly.

1. Pressing 【FUNCTION MENU】button to select tune menu, LCD displays "xxx Tune" temporarily, You can press 【+】/【-】buttons to adjust pitch, the largest adjustment range is ± 50 , it is to rise or reduce one half-tone.

2. Pressing 【+】 and 【-】 buttons at the same time, the pitch will recover to presetting value: 000. This parameter adjustment is valid for keyboard and styles.

Keyboard split setting

The position to split auto bass chord area and right hand area in keyboard is called "KEYBOARD SPLIT POINT". The keyboard in left hand area are used for controlling auto bass chord accompaniment generally when auto bass chord function was opened, the keyboard in left hand area also can be used for playing voice.

1. Pressing【FUNCTION MENU】button to choose keyboard split point setting menu, LCD displays "xxx KeySplit" temporarily, You can press 【-】/【+】buttons to set keyboard split point at this time, you also can play keys directly to do prompt setting. The adjustment range: 1~88.

2. Pressing 【-】 and 【+】 buttons at the same time, the keyboard split point will recover to presetting value: F#3 (34)



SPLIT

Beat type setting

1. Pressing **[FUNCTION MENU]** button to choose beat type menu, LCD displays "xxx BeatType" temporarily, You can press **[-]/[+]** button to choose beat type at this time, this function supplies 0, 2~9 (total 9 kinds of beats) for your selection.

2. Pressing **[-]** and **[+]** buttons at the same time, beat type will recover to presetting value: 004.

000 BeatType

Metronome volume setting

1. Pressing **[FUNCTION MENU+]** or **[FUNCTION MENU-]** button to choose metronome volume setting menu, LCD displays "xxx MetroVol" temporarily, You can press **[+]/[-]** button to set metronome volume at this time, range: 0~127.

2. Pressing **[+]** and **[-]** buttons at the same time, metronome volume will recover to presetting value: 080.

000 MetroVol

Reverb depth setting

1. Pressing **[FUNCTION MENU]** button to choose reverb depth setting menu, LCD displays "xxx ReverbLev" temporarily, You can press **[-]/[+]** button to set reverb depth at this time. Range: 0~127.

2. Pressing **[-]/[+]** buttons at the same time, reverb depth will recover to presetting value: 050.

000 ReverbLev

Chorus depth setting

1. Pressing **[FUNCTION MENU]** button to choose chorus depth setting menu, LCD displays "xxx ChorusLev" temporarily. You can press **[-]/[+]** button to set chorus depth at this time. Range: 0~127.

2. Pressing **[-]** and **[+]** buttons at the same time, Chorus depth will recover to presetting value: 000.

000 ChorusLev

MIDI receiving setting

1. Pressing **[FUNCTION MENU]** button to choose MIDI receiving channel setting menu, LCD displays "xxx Midi In" temporarily, You can press **[-]/[+]** button to set MIDI receiving channels at this time. Setting range: 1~16, ALL.

2. Pressing **[-]** and **[+]** buttons at the same time, MIDI channel will recover to presetting value: ALL.

000 Midi In

MIDI Sending setting

1. Pressing **[FUNCTION MENU]** button to choose MIDI sending channel setting menu, LCD displays "xxx Midi Out" temporarily. You can press **[-]/[+]** button to set MIDI sending channels at this time. Range: 1~16

2. Pressing **[-]** and **[+]** buttons at the same time, MIDI channel will recover to presetting value: 001.

000 Midi Out

Factory reset

Pressing **[-]** and **[+]** buttons when power is off, then, open the power, the system will recover to factory reset, and delete all users' data in this piano, including: Users' songs, users' registration memory. The LCD will display "Wait..!". The system will be entered into automatically after deletion was finished, then recover to normal open state.

Panel registration memory setting

This instrument has panel registration memory function, it can be used for saving your most favorite setting as to the setting can be tuned out easily and promptly when you need it, moreover, it can enable your performance to be more efficient. Panel registration memory function can almost store all setting of panel, you only need to press one button simply, the setting can be tuned out immediately.

Save setting to storage

1. This instrument has 4 pcs registration memory banks, every registration bank includes 2 groups storage memory state (M1~M2) .

2. When you press **[STORE]** button, press one of **[M1]** - **[M2]** button at the same time, present panel can be setted to registration memory. Please notice: This operation will cover previous stored registration memory.

Notice:

Holding **[STORE]** and **[M1]** buttons at the same time, open the power again, all registration memory will all recover to factory reset state at this time.



Tune out registration memory

Pressing one of **[M1]** - **[M2]** button to tune out one group setting to replace present state.

Choose memory bank

1. Pressing **[BANK]** button, LCD displays memory bank serial no. temporarily.

2. Pressing **[BANK]** button again and again at this time, you can choose to set memory bank. Range: 1~2

3. The following content can be stored in M1-M2 storage memory state:

Voice parameters: Main voice, Dual voice, Keyboard split point voice, Digital effect, Sound console.

Accompaniment parameters: Style, tempo, Auto bass chord open/close, paragraphs selection.

Function parameters: Touch, partial parameters in function menu.

【START/STOP】button again,the present song will loop play.

4.Pressing 【STYLE】、【RECORD】【VOICE】、【DUAL VOICE】etc function buttons,the song mode can be exited when the song has stopped playing.

Record your own songs

The record function of this piano can record/replay your performance,you can appreciate your own opus by replaying.You can record many pieces of users'songs in this piano ,every song can record 3pcs tracks at most,it is 1pc accompaniment track and 2pcs melody tracks.

The accompaniment track was used for recording style,it is songs'accompaniment, The melody track was used for recording playing melody.The accompaniment track and melody track can record at the same time,but,it cann't record 2pcs melody tracks at the same time ,of course,you also can only record melody or accompaniment separately;The accompaniment track and melody track can replay at the same time.

The users'song has storage function if there is power-fail,the data cann't loss when the power is off.

Start record

You need to choose one pc user's song that will be used for storing record before the record was starting and set record tracks.

1.Pressing【RECORD】button to enter into users'songs selection interface.The left top of LCD displays serial no. of users'songs,The characters display area displays users' songs name,The default name is "RecSong1".You can choose users'songs that need to store record by 【-】/【+】buttons.

2.Pressing 【RECORD】button to enter into record preparation state,"REC" marking lights in bottom part of LCD,4pcs beat points shine at the same time in beat display area. This piano will choose one melody track that has no data to store your record automatically,The track cursor shines in LCD ,it refers to the present track that stored record.

3.You can choose voice、 style , adjustment tempo etc.that you want to record in record preparation state.You can press 【TRACK1】、 【TRACK2】~【TRACK3】button to choose the tracks that you want to record,it means that the track was choosed when cursor shines. The accompaniment track and melody track can record at the same time,but cann't record 2pcs melody tracks at the same time.

4.To press【START/STOP】button or play piano's keys directly to start record after the record tracks were choosed.When the record accompaniment was choosed and the auto bass chord accompaniment function was opened,to play one effective chord in keyboard left hand area,the record can be started as well.

Notice:

The style data can only be recorded in accompaniment track.

The record track cursor has three kinds of state:Shine,Light,Go out.

Shining,it means that this track has been choosed for record,if this track has already have data, the original data will be covered if you continue to record in this track.Lighting,it means that this track has data,It wil replay recorded data synchronously in record process.Going out,it means that this track has no data or has data,but has been prohibited to replay when the record was going on.The tracks state can be switched by pressing【TRACK1】~【TRACK3】again and again in record preparation state.

This piano will choose one empty melody track to store record automatically (the system will choose automatically in the order of small to large.such as:if track2 has data,then,the system will choose track3 to store this time record)in record preparation state,if two tracks had already have data,then,it will choose track2 to store record.

Track1 : Accompaniment track

Track2/Track3: Melody track



001 RecSong1

001 StGrdPno

notes are correct or wrong, the chords or left hand melody part can sound.

Pressing **[Left]** & **[Right]** buttons at the same time, the left hand and right hand can be learned at the same time, The system will make estimation after the learning was over.

Stop record

1. Pressing **[Start/Stop]** button can stop record immediately in record process, Pressing **[Style]** or **[Voice]** selection button can enter into other function.

2. If the internal memory is full, the record will stop and store automatically in record process, "Rec_Full" will display in LCD temporarily to remind that the internal memory has been recorded full.

3. The record will stop automatically after the style had played ending over if you had chosen record accompaniment.



Replay recorded songs

1. The record will stop and enter into songs state automatically and loop play previous recorded users' songs immediately if **[RECORD]** button was pressed in record process.

2. Pressing **[SONG]** button to enter into song state in standby mode, all songs will loop play automatically. The serial no. of users' songs can be selected directly by pressing **[-]/[+]** buttons, such as: If there is no recorded data in one user's songs, "NoFile!" will display in LCD display screen, reminding that there is no recorded data in present files, moreover, the loop play will stop.

3. Choosing one user's song that has data in the state that songs has stopped, Pressing **[START/STOP]** button to start loop play this song.



Delete recorded songs

1. Pressing **[RECORD]** and **[SONG]** at the same time when the power is off, then, open the power, all users' songs will be cleared.

2. Pressing **[RECORD]** button for 2 seconds to enter into tracking deleting state in record preparation state, The LCD displays "Delete?". Pressing **[TRACK1]**, **[TRACK2]**, **[TRACK3]** to choose the track you want to delete in deleting state, when the cursor of one certain track lights, it indicates that the data of this track will be deleted, when the cursor of track goes out, it indicates that the data of this track will be kept. If the cursors of all tracks light, the data of complete song will be deleted when the deleting operation was carried out.

3. Pressing **[+]** button to carry out deleting operation after the tracks that you want to delete was choosed, it will return to record preparation state automatically after the operation was finished, Pressing **[-]** button to cancel deleting operation and return to record preparation state.



Play and control songs

This instrument has presetting many kinds of different types songs. Every song has learning function. (For detailed information, please see songs list)

Appreciate songs

1. Pressing **[SONG]** button to enter into song mode, LCD lights "SONG" marking, All songs will begin with loop play now.

2. You can choose the songs that you want to appreciate by numbers button or **[-]/[+]** buttons.

3. To press **[START/STOP]** button to stop playing in the state that songs are playing, but doesn't exit song state, pressing



Song control

1.Guiding beat function

The song will have guiding beat instructions before intro was played formally.

2.Fast forward, Fast backward, Play/Pause and stop functions of songs.

Pressing down [>>>] button can speed up to play songs when songs are playing,pressing down [<<<] button can return back songs,pressing down [▶/■] button can pause to play songs, pressing down [▶/■] button again to continue to play songs, pressing down [||] button can stop playing present songs.

3.The fragment loop function of song

Pressing down [↻] button can set starting point and ending point of loop play when the song are playing,pressing this button first time to set loop starting point,pressing this button second time to set loop ending point,when ending point was finished setting,the song will loop play the content between the two points.

Pressing down [↻] button can exit loop and continue to play songs in the state of fragment loop.



Song learning mode

The learning function of song are consist of [Lesson]、[Left]、[Right]these three buttons,these three buttons are valid only in song mode.All songs can be learned by three mode:Durationlearning,Pitch learning and play mode. This piano can give score based on your learning situation when the learning was over,it helps you to make progress continuously in learning process.

1.Enter into song learning mode

Pressing [Lesson]button to enter into song learning mode in the state of the song had been stopped play.

2.Choose left hand or right hand to learn songs

The songs of this instrument can be choosed for three different kinds of way to learn.You can choose the learning part you need by [Left]or [Right]buttons,if you haven't proceed with selection,the system will choose right hand learning for you automatically.

Notice:

The content of left hand learning will aslo be different based on different songs type.For style type songs,the left hand will be used for learning chords;For piano songs,the left hand will be used for learning part melody of left hand.The MIDI type songs doesn't support left hand learning function.The staff and chord display area in LCD will display melody or chords of songs when the songs are playing,It is convenient for following learning.



learning mode1: Duration learning

1.Pressing [Lesson]button to enter into learning mode1 in the state that the songs were stopped playing."Les1 R"will displays in LCD temporarily.The system will estimate the played duration of learner,it doesn't estimate the correctness of notes and chords in learning mode1,the song plays normally.

2.Pressing [Start/Stop]button to begin with songs learning.

If you choose right hand to learn songs,the melody part of right hand will be concealed.The learner only needs to play correct duration,the melody will sound in the process of song playing, it is no need to consider that the played notes are correct or wong.

If you choose left hand to learn songs,the chords of songs or left hand melody part will be concealed,the learner only need to play correct duration,it is no need to consider that the played

Learning mode2: Pitch learning

1. Pressing **[Learn]** button repeatedly to enter into learning mode2 in the state that song has been stopped play. "Les2 R" reminder marking lights in LCD . The system only estimates the correctness of pitch of notes that learner has played, The song can go ahead backwards when it needs learner to play correct notes. If the pitch of played notes is wrong, the song will be in waiting state until the correct notes was played.
2. Pressing **[Start/Stop]** button to begin to learn song, it will give estimation after the learning was over.

Les2 R

Learning mode3: Play mode

1. Pressing **[Learn]** button repeatedly to enter into learning mode3 in the state that song has been stopped play. "Les3 R" reminder marking lights in LCD . The system only estimate the correctness of duration and pitch that learner are playing comprehensively. The song plays normally, learner must play correct pitch based on origin alduration of song, then, it can be estimated correct by system
2. Pressing **[Start/Stop]** button to begin to learn song, it wil give estimation after the learning was over.

Les3 R

MP3 Play

- MP3 Jack:MP3 song can play by this jack
- Pressing **[Play/Pause]** button can switch present state of songs
- Pressing **[Song ^]** button ,one song goes backward,pressing **[Volume v]** button for longer time, the volume will reduce small.
- Pressing **[Song v]** button ,one song goes forward,pressing **[Volume ^]** button for longer time, the volume will increase large.

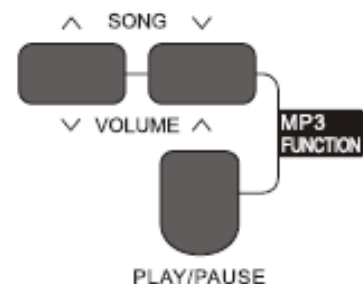

Voice List

(See attachment list)

Style List

(See attachment list)

Song list

(See attachment list)

Voice List

Classify	No.	Full english Name	English Abbr
Piano	1	Stereo Grand Piano	StGrdPno
Piano	2	Acoustic Grand Piano (wide) 1	GrandPnW
Piano	3	Acoustic Grand Piano (dark)	GrandPnD
Piano	4	Octave Piano 1	OctPno1
Piano	5	Octave Piano 2	OctPno2
Piano	6	Piano & Strings	Pno&Str
Piano	7	Piano & Choir	Pno&Cho
Piano	8	Acoustic Grand Piano	GrandPno
Piano	9	Stereo Bright Piano	StBrtPno
Piano	10	Bright Acoustic Piano	BritePno
Piano	11	Bright Acoustic Piano (wide) 1	BritePnW
Piano	12	Chorus Piano	ChoruPno
Piano	13	Electric Grand Piano	E. Grand
Piano	14	Electric Grand Piano (wide)	E. GrandW
Piano	15	Stereo Honk-Tonk	StHonkTo
Piano	16	Honky-tonk Piano	HnkyTonk
Piano	17	Honky-tonk Piano (wide) 1	HnyTonkW
Piano	18	Stereo Hard Electric Piano	StHarEp
Piano	19	Detuned Electric Piano 1	DetunEP1
Piano	20	Detuned Electric Piano 2	DetunEP2
Piano	21	Electric Piano 1	E. Piano 1
Piano	22	Electric Piano 2	E. Piano 2
Piano	23	Electric Piano (wide) 1	EPnoW1
Piano	24	Electric Piano (wide) 2	EPnoW2
Piano	25	EP Legend	EP Legend
Piano	26	EP Phase	EP Phase
Piano	27	60's Electric Piano	60'sEP
Piano	28	Electric Piano 1 (velocity mix)	E. PnoV1
Piano	29	Electric Piano 2 (velocity mix)	E. PnoV2
Piano	30	Velocity Crossfade Electric Piano	VeCrosEP
Piano	31	Layered Electric Piano 1	LayerEP1
Piano	32	Layered Electric Piano 2	LayerEP2
Piano	33	Nylon Electric Piano	NylonEP
Piano	34	Warm Electric Piano	WarmEP
Piano	35	Grand Harpsichord	GraHarps
Piano	36	Harpsichord 1	Harpsi
Piano	37	Harpsichord 2	Harpsi2
Piano	38	Harpsichord (wide)	HarpsiW
Piano	39	Harpsichord (octave mix) 1	HarpsiO
Piano	40	Harpsichord Release	HarpsiR
Piano	41	Harpsichord (with key off)	HarpsiOf
Piano	42	Clavi 1	Clavi
Piano	43	Clavi 2	Clavi 2
Piano	44	Clavi (wide) 1	ClaviW1
Piano	45	Clavi (wide) 2	ClaviW2
Piano	46	Clavi Wah	ClaviWa
Piano	47	Pulse Clavi	PulseClv
Chromatic Percussion	48	Celesta 1	Celesta
Chromatic Percussion	49	Celesta 2	Celesta2
Chromatic Percussion	50	Birght Celeasta	BirCelea
Chromatic Percussion	51	Celesta & Sine	Celes&Si
Chromatic Percussion	52	Reecho Bell	ReechBell
Chromatic Percussion	53	Celesta & Music Box	Celes&MB
Chromatic Percussion	54	Glockenspiel 1	Glocken
Chromatic Percussion	55	Glockenspiel 2	Glocken2
Chromatic Percussion	56	Music Box 1	MusicBox
Chromatic Percussion	57	Music Box 2	MusicBo2
Chromatic Percussion	58	Music Box 3	MusicBo3
Chromatic Percussion	59	Toy Box	ToyBox
Chromatic Percussion	60	Music Box & Harp	Mbx&Harp
Chromatic Percussion	61	Stereo Vibrapho	StVibes
Chromatic Percussion	62	Rigid Vibraphone	RigiVibe

Voice List

Classify	No.	Full english Name	English Abbr
Chromatic Percussion	63	Vibraphone 1	Vibra
Chromatic Percussion	64	Vibraphone 2	Vibra2
Chromatic Percussion	65	Vibraphone (wide) 1	VibraW
Chromatic Percussion	66	Vibraphone (wide) 2	VibraW2
Chromatic Percussion	67	Vibraphone & Bell	Bell&Vib
Chromatic Percussion	68	Marimba 1	Marimba
Chromatic Percussion	69	Marimba 2	Marimba2
Chromatic Percussion	70	Marimba (wide)	MarimbaW
Chromatic Percussion	71	Stereo Marimba	StMarim
Chromatic Percussion	72	Marimba & Vibraphone	Mar&Vib
Chromatic Percussion	73	Xylophone 1	Xylophone
Chromatic Percussion	74	Xylophone 2	Xylopho2
Chromatic Percussion	75	Tubular Bells	TubuIBell
Chromatic Percussion	76	Church Bell	Chu rBell
Chromatic Percussion	77	Carillon	Carillon
Chromatic Percussion	78	Dulcimer	Dulcimer
Chromatic Percussion	79	Santur	Santur
Organ	80	Drawbar Organ 1	DrawbOrgan
Organ	81	Drawbar Organ 2	DrawbOrgan 2
Organ	82	Soft Stereo Drawbar Organ	SfDrawOrgan
Organ	83	Mellow Drawbar Organ	MelIDrOr
Organ	84	Detuned Drawbar Organ 1	DeDraOr
Organ	85	Detuned Drawbar Organ 2	DeDraOr2
Organ	86	Italian 60's Organ	60'sOrgn
Organ	87	1970 Percussive Organ	1970Pc:Or
Organ	88	Percussive Organ 1	PercOrgn1
Organ	89	Percussive Organ 2	PercOrg2
Organ	90	Light Click Organ	LClickOr
Organ	91	Detuned Percussive Organ	DePerOrg
Organ	92	Stereo Rotary Organ	StRotaOr
Organ	93	Rock Organ	RockOrgn
Organ	94	Rotary Organ	RotaOrgn
Organ	95	Slow Rotary Organ	SloRotOr
Organ	96	Detuned Church Organ	DeChuOrg
Organ	97	Church Organ 1	Chu rOrgn
Organ	98	Church Organ 2	Chu rOrg2
Organ	99	Church Organ (octave mix)	Chu rOrgO
Organ	100	Reed Organ	ReedOrgn
Organ	101	Puff Organ	PuffOrgn
Organ	102	Accordion 1	Accordion
Organ	103	Accordion 2	Accordin2
Organ	104	Accordion 3	Accordin3
Organ	105	Mustte	Mustte
Organ	106	Accord It Solo	AccordSo
Organ	107	Sweet Harmonica	SwethHarm
Organ	108	Harmonica 1	Harmonica
Organ	109	Harmonica 2	Harmonic2
Organ	110	Tango Accordion	TangoAcd
Guitar	111	Acoustic Guitar (nylon) 1	NylonGtr
Guitar	112	Acoustic Guitar (nylon) 2	NylonGt2
Guitar	113	Acoustic Guitar (nylon + key off)	NyIGtrOf
Guitar	114	Ukulele	Uku lele
Guitar	115	Velocity Nylon Guitar	NyInGtVe
Guitar	116	Chorus Nylon Guitar	Cho NyGt
Guitar	117	Bright Nylon Guitar	BrNyGt
Guitar	118	Acoustic Guitar (steel) 1	SteelGtr
Guitar	119	Acoustic Guitar (steel) 2	SteelGt2
Guitar	120	Steel Guitar with Body Sound	SteelBdy
Guitar	121	Tremolo Steel Guitar	TremGt
Guitar	122	Mandolin	Mandolin
Guitar	123	12-Strings Guitar	12StrGtr
Guitar	124	Chorus Steel Guitar	ChoStEGt

Voice List

Classify	No.	Full english Name	English Abbr
Guitar	125	Nylon & Steel Guitar	Ny&SteGt
Guitar	126	Stereo Steel Guitar	StSteGt
Guitar	127	Steel Guitar Bend	GtBend
Guitar	128	Steel Guitar Harmonics	GtHarm
Guitar	129	Velocity Steel Guitar 1	VelSte1
Guitar	130	Velocity Steel Guitar 2	VelSte2
Guitar	131	Velocity Steel Guitar 3	VelSte3
Guitar	132	Electric Guitar (jazz) 1	JazzGtr
Guitar	133	Electric Guitar (jazz) 2	JazzGt2
Guitar	134	Electric Guitar (pedal steel)	PedalGtr
Guitar	135	Mellow Guitar	MellGt
Guitar	136	Velocity Jazz Guitar	JazzGtVe
Guitar	137	Jazz Guitar Detuned	JazzGtDt
Guitar	138	Mid Tone Guitar	MidTonGt
Guitar	139	Electric Guitar (clean) 1	CleanGtr
Guitar	140	Electric Guitar (clean) 2	CleanGtr2
Guitar	141	Stereo Clean Guitar	StCleGtr
Guitar	142	Velocity Clean Guitar	CleGtVel
Guitar	143	Electric Guitar (detuned clean)	DetClnGt
Guitar	144	Electric Guitar (muted velo -sw)	MutVelGt
Guitar	145	Electric Guitar (muted)	MutedGtr
Guitar	146	Electric Guitar (funky cutting)	FunkGt
Guitar	147	Jazz Man	JazzMan
Guitar	148	Stereo Muted Guitar	StMuGt
Guitar	149	Guitar Pinch	GtPinch
Guitar	150	Overdriven Guitar	Overdrive
Guitar	151	Distortion Guitar 1	DistGt
Guitar	152	Distortion Guitar 2	DistGtr2
Guitar	153	Distortion Guitar (with feedback) 1	FeedbkGt
Guitar	154	Distorted Rhythm Guitar	DistRyth
Guitar	155	5th Distortion	5thDist
Guitar	156	Stereo Distorted Guitar	StDistor
Guitar	157	Guitar Feedback	GtFdbk
Guitar	158	Guitar Harmonics	GtrHarmo
Bass	159	Acoustic Bass 1	AcoBass
Bass	160	Acoustic Bass 2	AcoBass2
Bass	161	Jazz Style	JazzSty
Bass	162	A. Bass & Mute G.T.	Ba&GtMu
Bass	163	Resonant Bass	ResBass
Bass	164	Wah Bass 1	WahBass1
Bass	165	Electric Bass (finger) 1	FngrBass
Bass	166	Electric Bass (finger) 2	FngrBas2
Bass	167	Electric Bass (finger) 3	FngrBas3
Bass	168	Finger Slap Bass	FngrSlap
Bass	169	Electric Bass (pick) 1	PickBass
Bass	170	Electric Bass (pick) 2	PickBas2
Bass	171	Fretless Bass 1	Fretless
Bass	172	Fretless Bass 2	Fretless2
Bass	173	Slap Bass 1	SlapBass
Bass	174	Slap Bass 2	SlapBass2
Bass	175	Synth Bass 1	SynBass
Bass	176	Synth Bass 2	SynBass2
Bass	177	Synth Bass 3 (resonance)	ResoBass
Bass	178	Synth Bass 4 (attack)	Atac kBass
Bass	179	Synth Bass (warm)	WarmBass
Bass	180	Clavi Bass	ClavBass
Bass	181	Hammer	Hammer
Bass	182	Synth Bass (rubber)	RubbBass
Bass	183	Attack Pulse	Atac kPls
Strings & Orchestral Instruments	184	The Violin	TheVin
Strings & Orchestral Instruments	185	Violin 1	Violin

Voice List

Classify	No.	Full english Name	English Abbr
Strings & Orchestral Instruments	186	Violin 2	Violin2
Strings & Orchestral Instruments	187	Violin (slow attack)	SIViolin
Strings & Orchestral Instruments	188	Soft Violin	SoftVin
Strings & Orchestral Instruments	189	Viola 1	Viola
Strings & Orchestral Instruments	190	Viola 2	Viola2
Strings & Orchestral Instruments	191	Cello 1	Cello
Strings & Orchestral Instruments	192	Cello 2	Cello2
Strings & Orchestral Instruments	193	Celloen 16'	Celloen
Strings & Orchestral Instruments	194	Contrabass 1	Contrabs
Strings & Orchestral Instruments	195	Contrabass 2	Contrbs2
Strings & Orchestral Instruments	196	Tremolo Strings 1	TremStr
Strings & Orchestral Instruments	197	Tremolo Strings 2	TremStr2
Strings & Orchestral Instruments	198	Pizzicato Strings 1	PizzStr
Strings & Orchestral Instruments	199	Pizzicato Strings 2	PizzStr2
Strings & Orchestral Instruments	200	Orchestral Harp 1	Harp
Strings & Orchestral Instruments	201	Orchestral Harp 2	Harp2
Strings & Orchestral Instruments	202	Timpani 1	Timpani
Strings & Orchestral Instruments	203	Timpani 2	Timpani2
Ensemble	204	String Ensembles 1	Strings1
Ensemble	205	String Ensembles 2	Strings2
Ensemble	206	Synth Strings 1	SynStrs1
Ensemble	207	Synth Strings 2	SynStrs2
Ensemble	208	Synth Strings 3	SynStrs3
Ensemble	209	Synth Strings 4	SynStrs4
Ensemble	210	Stereo Slow Strings	SSlowStr
Ensemble	211	Strings and Brass	Str&Bras
Ensemble	212	Legato Strings	LegatStr
Ensemble	213	Orchestra	Orchstr
Ensemble	214	60's Strings	60'sStr
Ensemble	215	Solo Strings	SoloStr
Ensemble	216	Choir Aahs 1	ChoirAah
Ensemble	217	Choir Aahs 2	ChoirAh2
Ensemble	218	Humming	Humming
Ensemble	219	Voice Oohs	VoiceOoh
Ensemble	220	Analog Voice	AnaVoice
Ensemble	221	Synth Voice	SynVoice
Ensemble	222	Bass Hit Plus	BassHit
Ensemble	223	Orchestra Hit 1	OrchHit
Ensemble	224	Orchestra Hit 2	OrchHi2
Ensemble	225	Euro Hit	Eu roHit
Ensemble	226	6th Hit	6thHit
Brass	227	Trumpet 1	Trumpet
Brass	228	Trumpet 2	Trumpet2
Brass	229	Trumpet 3	Trumpet3
Brass	230	Dark Trumpet Soft	DarkTrp
Brass	231	Sweet Trumpet	SweetTp
Brass	232	Trombone 1	Trombone
Brass	233	Trombone 2	Trmbone2
Brass	234	Bright Trombone	BritBone
Brass	235	Tuba 1	Tuba
Brass	236	Tuba 2	Tuba2
Brass	237	Muted Trumpet 1	MuteTrp1
Brass	238	Muted Trumpet 2	MuteTrp2
Brass	239	French Horn 1	FrHorn
Brass	240	French Horn 2 (warm)	FrHorn2
Brass	241	Brass Section 1	Brass
Brass	242	Brass Section 2 (octave mix)	Brass2
Brass	243	Brass Section 3	Brass3
Brass	244	Brass Section 4	Brass4
Brass	245	Brass Section 5	Brass5
Brass	246	Brass Band	BrasBand

Voice List

Classify	No.	Full english Name	English Abbr
Brass	247	Bright Brass Section	BrBraSec
Brass	248	Brass & Strings	Bras&Str
Brass	249	Synth Brass 1	SynBras1
Brass	250	Synth Brass 2	SynBras2
Brass	251	Synth Brass 3	SynBras3
Brass	252	Synth Brass 4	SynBras4
Brass	253	Analog Synth Brass 1	AnaBras1
Brass	254	Analog Synth Brass 2	AnaBras2
Brass	255	Jump Brass	JumpBras
Brass	256	Synth Brass & Strings 1	SyBr&St1
Reed	257	Soprano Sax 1	SprnoSax
Reed	258	Soprano Sax 2	SprnSax2
Reed	259	Sweet Soprano Sax	SweSpSax
Reed	260	Alto Sax	AltoSax
Reed	261	Soft Alto Sax	SoftAlto
Reed	262	Tenor Sax 1	TenoSax
Reed	263	Tenor Sax 2	TenoSax2
Reed	264	Baritone Sax	BariSax
Reed	265	Sweet Oboe	SweetOboe
Reed	266	Oboe 1	Oboe
Reed	267	English Horn 1	EngHorn
Reed	268	Bassoon 1	Bassoon
Reed	269	Clarinet 1	Clarinet
Reed	270	Clarinet 2	Clarinet2
Pipe	271	Piccolo	Piccolo
Pipe	272	Flute	Flute
Pipe	273	Sweet Flute	SweetFlut
Pipe	274	Recorder	Recorder
Pipe	275	Sweet Pan Flute	SwPanFu
Pipe	276	Pan Flute	PanFlute
Pipe	277	Blown Bottle	Bottle
Pipe	278	Shakuhachi	Shakhchi
Pipe	279	Whistle 1	Whistle
Pipe	280	Whistle 2	Whistle2
Pipe	281	Ocarina	Ocarina
Synth Lead	282	Lead 1 (square)	SquareLd
Synth Lead	283	Square	Square
Synth Lead	284	Lead 1b (sine)	SineLead
Synth Lead	285	Square Lead 1	SquarLd1
Synth Lead	286	Lead 1a (square 2)	SquarLd2
Synth Lead	287	Lead 2a (sawtooth 2)	SawLead2
Synth Lead	288	Lead 2d (sequenced analog)	SquAnaLd
Synth Lead	289	Lead 2 (sawtooth)	SawLead1
Synth Lead	290	Lead 2b (saw + pulse)	SawPlsLd
Synth Lead	291	Lead 2c (double sawtooth)	DubSawLd
Synth Lead	292	Lead 3 (calliope)	CalliopLd
Synth Lead	293	Lead 4 (chiff)	ChiffLd
Synth Lead	294	Lead 5 (charang)	CharanLd
Synth Lead	295	Lead 5a (wire lead)	WireLead
Synth Lead	296	Lead 6 (voice)	VoiceLd
Synth Lead	297	Lead 7 (fifths)	FifthsLd
Synth Lead	298	Lead 8 (bass + lead)	BassLead
Synth Lead	299	Lead 8a (soft wrl)	SftWrLd
Synth Pad	300	Pad 1 (new age)	NewAgePd
Synth Pad	301	New Year Pad	NewYrPd
Synth Pad	302	Pad 2 (warm)	WarmPad
Synth Pad	303	Pad 2a (sine pad)	SinePad
Synth Pad	304	Pad 3 (polysynth) 1	PolySyPd
Synth Pad	305	Pad 4 (choir)	ChoirPad
Synth Pad	306	Pad 4a (itopia)	ItopiaPd
Synth Pad	307	Pad 5 (bowed) 1	BowedPad

Voice List

Classify	No.	Full english Name	English Abbr
Synth Pad	308	Pad 6 (metallic) 1	MetalPad
Synth Pad	309	Pad 7 (halo) 1	HaloPad
Synth Pad	310	Pad 8 (sweep) 1	SweepPad
Synth Pad	311	FX 1 (rain)	FXRain
Synth Pad	312	FX 2 (soundtrack)	Soundtrk
Synth Pad	313	FX 3a (synth mallet)	SynMalet
Synth Pad	314	FX 3 (crystal)	Crystal
Synth Pad	315	FX 4 (atmosphere)	Atmosphr
Synth Pad	316	Warm Air	WarmAir
Synth Pad	317	FX 5 (brightness)	Bright
Synth Pad	318	FX 6 (goblins)	Goblins
Synth Pad	319	FX 7 (echoes) 1	Echoes
Synth Pad	320	FX 7a (echo bell) 1	EchoBell
Synth Pad	321	FX 7b (echo pan)	EchoPan
Synth Pad	322	FX 8 (sci-fi)	Sci-Fi
Ethnic Misc.	323	Sitar 1	Sitar
Ethnic Misc.	324	Sitar 2 (bend)	Sitar2
Ethnic Misc.	325	Banjo	Banjo
Ethnic Misc.	326	Shamisen	Shamisen
Ethnic Misc.	327	Koto	Koto
Ethnic Misc.	328	Taisho Koto	TaishoKt
Ethnic Misc.	329	Kalimba	Kalimba
Ethnic Misc.	330	Bag Pipe	Bagpipe
Ethnic Misc.	331	Fiddle	Fiddle
Ethnic Misc.	332	Shanai	Shanai
Percussive	333	Tinkle Bell	TnklBell
Percussive	334	Steel Drums	SteelDrm
Percussive	335	Woodblock	WoodBlok
SFX	336	Seashore	Seashore
SFX	337	Thunder	Thunder
SFX	338	Telephone Ring 1	Telephone
SFX	339	Applause	Applause
Combined Voice	340	Stereo Piano & Strings Pad	StPn&Str
Combined Voice	341	Stereo Piano & Choir	StPn&Cho
Combined Voice	342	Stereo Piano & Synth Strings	StPn&Syn
Combined Voice	343	Stereo Piano & Warm Pad	StPn&Pad
Combined Voice	344	Rock Organ & Strings	RoOr&Str
Combined Voice	345	Steel Guitar & Warm Pad	StGt&Pad
Combined Voice	346	Orchestra	Orchest
Combined Voice	347	Full Strings 1	FullStr1
Combined Voice	348	Symphonic	Symphon
Chinese Instruments	349	GuZheng	GuZheng
Chinese Instruments	350	PiPa	PiPa
Chinese Instruments	351	ErHu 1	ErHu 1
Chinese Instruments	352	Bandi	Bandi
Chinese Instruments	353	Hulusi	Hulusi
Chinese Instruments	354	LuSheng 1	LuShen1
Chinese Instruments	355	SuoNa	SuoNa
Chinese Instruments	356	Paixiao	Paixiao
Drum Set	357	Standard Set	StandSet
Drum Set	358	Room Set	RoomSet
Drum Set	359	Power Set	PowerSet
Drum Set	360	Jazz Set	JazzSet

Style List

Classify	No.	Full english Name	English Abbr
8 BEAT	1	8Beat Piano	8BtPiano
8 B EAT	2	8Beat 1	8Beat 1
8 B EAT	3	8Beat Shuffle	8BtShufl
8 B EAT	4	Guitar Pop 1	GtPop1
8 B EAT	5	8Beat Hip Hop	8BtHiHop
8 B EAT	6	8Beat R&B	8Beat R&B
8 B EAT	7	8Beat Pop	8BtPop
8 B EAT	8	Pop Funk 1	PopFunk1
8 B EAT	9	Rhythm & Beat 1	Rhy&Bt 1
8 B EAT	10	8Beat Disco 1	8BtDisc1
8 B EAT	11	8Beat Rock	8BtRock
8 B EAT	12	8Beat 2	8Beat 2
8 B EAT	13	Sweet Beat	SweetBt
8 B EAT	14	8Beat Dance	8BtDance
8 B EAT	15	8Beat 3	8Beat 3
8 B EAT	16	60's 8Beat	60's8Bt
16 BEAT	17	16Beat 1	16Beat 1
16 BEAT	18	16Beat Funk 1	16BtFuk1
16 BEAT	19	16Beat Ballad 1	16BtBld1
16 BEAT	20	16Beat R&B	16BtR&B
16 BEAT	21	Pop 16Beat 1	Pop16Bt 1
16 BEAT	22	16Beat Dance	16BtDanc
16 BEAT	23	16Beat 2	16Beat 2
16 BEAT	24	Modern 16Beat	Modrn16B
16 BEAT	25	16Beat Hot	16BtHot
16 BEAT	26	16Beat Modern	16BtModr
16 BEAT	27	16Beat 3	16Beat 3
16 BEAT	28	Cool Beat	CoolBeat
16 BEAT	29	16Beat Ballad 2	16BtBld2
16 BEAT	30	16Beat 4	16Beat4
16 BEAT	31	Pop Shuffle	PopShufl
POP	32	Pop Rock 1	PopRock1
POP	33	Pop Dance 1	PopDanc1
POP	34	Pop Fusion	PopFusn
POP	35	Analog Night 1	AnalgNt 1
POP	36	6/8 Pop	6/8Pop
POP	37	Brit. Pop 1	BritPop1
POP	38	Brit. Pop 2	BritPop2
POP	39	Pop Hit	PopHit
POP	40	Fusion Shuffle	FusShufl
POP	41	Pop Beat	PopBeat
POP	42	Soft Beat	SoftBeat
POP	43	60's Pop	60'sPop
POP	44	Sting Latin	StigLatn
BALLAD	45	R&B Ballad 1	R&BBad1
BALLAD	46	Guitar Ballad	GtBallad
BALLAD	47	Ballad Rock	BalladRk
BALLAD	48	Piano Pop	PianoPop
BALLAD	49	Soft Ballad	SoftBald
BALLAD	50	Natural Ballad	NatuBld
BALLAD	51	Love Ballad	LoveBld
BALLAD	52	Easy Ballad	EasyBld
BALLAD	53	Slow Ballad	SlowBald
BALLAD	54	Folk Ballad	FolkBld
BALLAD	55	Pop Ballad 1	PopBld1
BALLAD	56	EP Ballad	EPBallad
ROCK	57	Rock	Rock
ROCK	58	New Wave	NewWave
ROCK	59	Ska	Ska
ROCK	60	Slow Rock	SlowRock
ROCK	61	70's Rock & Roll	70'sRock
ROCK	62	Folk Rock	FolkRock

Style List

Classify	No.	Full english Name	English Abbr
ROCK	63	Soft Rock	SoftRock
ROCK	64	Easy Rock	EasyRock
ROCK	65	New Shuffle	NewShuffl
ROCK	66	Rock Hip Hop	RkHipHop
ROCK	67	Rock & Roll 1	R'N'R1
ROCK	68	Rock & Roll 2	R'N'R2
BALLROOM	69	Tango 1	Tango 1
BALLROOM	70	Spain Matador	Matador
BALLROOM	71	Twist 1	Twist 1
BALLROOM	72	Big Band Fox	BandFox
BALLROOM	73	Tango 2	Tango 2
BALLROOM	74	Slow Fox	SlowFox
BALLROOM	75	Slow Waltz 1	SlowWlz1
BALLROOM	76	Swing Fox	SwingFox
BALLROOM	77	Salsa 1	Salsa 1
BALLROOM	78	Cha Cha 1	ChaCha1
BALLROOM	79	Cha Cha 2	ChaCha2
BALLROOM	80	Beguine 1	Beguine 1
BALLROOM	81	Beguine 2	Beguine 2
BALLROOM	82	Rumba 1	Rumba 1
BALLROOM	83	Samba 1	Samba 1
BALLROOM	84	Jive	Jive
BALLROOM	85	Fox Trot	FoxTrot
DANCE	86	Techno 1	Techno 1
DANCE	87	Hip Hop 1	HipHop1
DANCE	88	Dream Dance	DrnDance
DANCE	89	House	House
DANCE	90	Down Beat	Down Beat
DANCE	91	Progressive	Progress
DANCE	92	Rap 1	Rap 1
DANCE	93	Disco	Disco
DANCE	94	Soft Disco	Soft Disc
DANCE	95	Disco Party	DscParty
DANCE	96	70's Disco	70'sDisc
DANCE	97	Club Dance	Club Danc
DANCE	98	Euro Dance	Euro Danc
DANCE	99	Hip Hop 2	HipHop2
SOUL & FUNK	100	Funk 1	Funk 1
SOUL & FUNK	101	Classic Funk	ClasFunk
SOUL & FUNK	102	Gospel Swing	Go pSwing
SOUL & FUNK	103	Gospel	Gospel
SOUL & FUNK	104	Funk 2	Funk 2
SOUL & FUNK	105	Electric Funk	ElecFunk
SOUL & FUNK	106	Groove Funk	GrooveFk
SOUL & FUNK	107	Cool Funky	Col Funky
SOUL & FUNK	108	Jazz Funk	JazzFu nk
SOUL & FUNK	109	Groove	Groove
SOUL & FUNK	110	Soul	Soul
SOUL & FUNK	111	Hip Hop Beat	Hip Hop Bt
SOUL & FUNK	112	R&B	R&B
SOUL & FUNK	113	Soul Beat	SoulBeat
SWING & JAZZ	114	Latin Jazz 1	LatinJz1
SWING & JAZZ	115	Big Band	BigBand
SWING & JAZZ	116	Dixieland 1	Dixland1
SWING & JAZZ	117	Broadway Big Band	BwayBand
SWING & JAZZ	118	Swing	Swing
SWING & JAZZ	119	Latin Jazz 2	LatinJz 2
SWING & JAZZ	120	Fusion	Fusion
SWING & JAZZ	121	Acid Jazz	AcidJazz
SWING & JAZZ	122	Cool Jazz Ballad	CoolJzBd
SWING & JAZZ	123	Swing Shuffle	SwingSfl
SWING & JAZZ	124	Big Band Medium	BandMid

Style List

Classify	No.	Full english Name	English Abbr
COU NTRY	125	Country Pop 1	CntyPop1
COU NTRY	126	Bluegrass 1	Bluegrs1
COU NTRY	127	Country 8Beat	Ct8Beat
COU NTRY	128	Modern Country	ModernCt
COU NTRY	129	Country Pop 2	CntyPop2
COU NTRY	130	Bluegrass 2	Bluegrs2
COU NTRY	131	2/4 Country	2/4Cntry
COU NTRY	132	Country Quick Steps	QuickStp
COU NTRY	133	Country Folk	CntyFolk
COU NTRY	134	Country Shuffle	CnyShuffl
Latin & Latin Dance	135	Bossa Nova	BossaNov
Latin & Latin Dance	136	Latin	Latin
Latin & Latin Dance	137	Tikitikita	Tikitkita
Latin & Latin Dance	138	Lambada	Lambada
Latin & Latin Dance	139	Pop Cha Cha 1	PChaCha1
Latin & Latin Dance	140	Pop Cha Cha 2	PChaCha2
Latin & Latin Dance	141	Salsa 2	Salsa2
Waltz & TRADITIONAL	142	Waltz	Waltz
Waltz & TRADITIONAL	143	Old Waltz	OldWaltz
Waltz & TRADITIONAL	144	English Waltz	EngWaltz
Waltz & TRADITIONAL	145	German Waltz	GemWaltz
Waltz & TRADITIONAL	146	ViennaWaltz	VinaWtz
Waltz & TRADITIONAL	147	Slow Waltz 2	SlwWltz2
Waltz & TRADITIONAL	148	Jazz Waltz	JzWaltz
Waltz & TRADITIONAL	149	Polka	Polka
Waltz & TRADITIONAL	150	March	March
CHINESE FOLK	151	Chinese R&B 1	ChnR&B1
CHINESE FOLK	152	GuangXi Folk	GuangXi
CHINESE FOLK	153	Chinese Folk 1	ChnFolk1
CHINESE FOLK	154	NeiMeng Folk	NeiMFolk
CHINESE FOLK	155	Jiang Nan Folk1	JangNan1
CHINESE FOLK	156	XinJiang Folk	XJangFok
CHINESE FOLK	157	YangGe	YangGe
CHINESE FOLK	158	YunNan	Yu nNan
CHINESE FOLK	159	Jubilance	Ju bilanc
CHINESE FOLK	160	GuangDong	Gung Dong

Song list

Classify	No.	Full english Name	English Abbr
FOLK & COUNTRY	1	Jambalaya	Jambalay
FOLK & COUNTRY	2	Ding! Dong! Merrily On High	DingDong
FOLK & COUNTRY	3	Battle Hymne Of The Republic	Battle
FOLK & COUNTRY	4	The Old Gray Mare	GrayMare
FOLK & COUNTRY	5	American Patrol	USPatrol
FOLK & COUNTRY	6	Christmas Is Coming	IsComing
FOLK & COUNTRY	7	Sippin' Gider Through A Straw	SCTStraw
FOLK & COUNTRY	8	Christmas Sound	Sound
GOLDEN & POP	9	On London Bridge	LdBridge
GOLDEN & POP	10	Are You Lonesome Tonight	Lonesome
GOLDEN & POP	11	Der Deitcher's Dog	DerD Dog
GOLDEN & POP	12	Joy To The World	JoyWorld
GOLDEN & POP	13	Silent Night	SltNight
GOLDEN & POP	14	Ave Maria	AveMaria
GOLDEN & POP	15	Five Hundred Miles	FHMiles
GOLDEN & POP	16	Happy New Year	HappyNY
GOLDEN & POP	17	It's Beginning To Look A Lot Like Christmas	LikeXmas
GOLDEN & POP	18	Jeanie With The Light Brown Hair	Light Hair
GOLDEN & POP	19	My Bonnie	MyBonnie
GOLDEN & POP	20	Song Of The Pearlfisher	SongOfTP
CLASSICAL	21	Swan	Swan
CLASSICAL	22	Prelude To Act 2 (Swan Lake)	SwanLak1
CLASSICAL	23	Valse (Swan lake)	SwanLak2
CLASSICAL	24	The Happy Farmer	HpFarmer
CLASSICAL	25	The Sleeping Beauty	SleepBty
CLASSICAL	26	La Traviata	LaTravia
CLASSICAL	27	Wiegenlied	Wiegenli
CLASSICAL	28	Mov.2 Adagio Non Troppo Piano Sonata No.9 in D	Sonata9
CLASSICAL	29	Mov.1 Andante Grazioso Piano Sonata No.11 In A [Alla Tur Sonata 11 ca]	Sonata11
CLASSICAL	30	Prelude In C	Prelude
CLASSICAL	31	Chinese Dance	ChDance
CLASSICAL	32	Emperors Waltz	EmprWaltz
CLASSICAL	33	March Militaire	MilMar1
CLASSICAL	34	Symphony No.40	Symphony
JAZZ & FUSION	35	ShanZhaShu	ShanZhaS
JAZZ & FUSION	36	You Are My Sunshine	MySun
JAZZ & FUSION	37	June Samba	Ju nSamba
JAZZ & FUSION	38	Funk	Funk
JAZZ & FUSION	39	I Can.....	I Can...
JAZZ & FUSION	40	Sea Shore	SeaShore

Song list

Classify	No.	Full english Name	English Abbr
JAZZ & FUSION	41	Guitar & Saxphone	Gt&Sax
JAZZ & FUSION	42	The Hip Hop's Night	HipHopNt
JAZZ & FUSION	43	Blue Lunch	BlueLunch
JAZZ & FUSION	44	Cobweb	Cobweb
JAZZ & FUSION	45	Wine	Wine
JAZZ & FUSION	46	Jazz Old Man	JzOldMan
JAZZ & FUSION	47	Dark Eyes	DarkEyes
JAZZ & FUSION	48	Carlos	Carlos
JAZZ & FUSION	49	Sad	Sad
JAZZ & FUSION	50	The Jazz	TheJazz
PIANO	51	Fur Elise	FurElise
PIANO	52	Military March	Mmarch
PIANO	53	Habanera	Habanera
PIANO	54	Minuet	Minuet
PIANO	55	Austria Variation	Avariati
PIANO	56	Old Macdonald Had A Farm	OldAFarm
PIANO	57	Wedding March	Wedding
PIANO	58	2-Part Invention #13 In A Minor.B.W. Iii	Invention
PIANO	59	Minuet In G	MinuetG
PIANO	60	Turkish March	TurkishM
PIANO	61	Hey Diddle Diddle	HeDiddle
PIANO	62	Italian Polka	ItaPolka
PIANO	63	Moseta Dance	MosetaDn
PIANO	64	Bullie Dance	BullieDn
PIANO	65	Waltz in A Flat Op.39 No.15	Waltz 1
PIANO	66	Wild Rose	WildRose
PIANO	67	Away In A Manger	AwayInAM
PIANO	68	Jack & Jill	JackJill
PIANO	69	Angles We Have Heard On High	Angles
PIANO	70	Waltz	Waltz
PIANO	71	Did You Ever See A Lassie	Lassie
PIANO	72	Chopsticks	Chopstick
PIANO	73	Four Little Swans	FLSwans
PIANO	74	Old France	OldFrance
PIANO	75	Jesus Saviour Pilot Me	PilotMe
PIANO	76	Eclogue	Eclogue
PIANO	77	Santa Claus Is Coming To Town	SantaCT
PIANO	78	Brave Cavalier	Cavalier
PIANO	79	America The Beautiful	USFair
PIANO	80	Music Box Dancer	Dancer

WEEE-Declaration / Disposal



Your product is designed and manufactured with materials and components of high quality, which are recyclable and can be reused. The symbol means that your product should be disposed of separately from household waste when it reaches its end of life. Please dispose of this equipment at your local collection point or recycling center. Please help to protect the environment in which we all live.

All specifications and appearances are subject to change without notice. All information was correct at time of printing. Musikhaus Kirstein GmbH does not guarantee for the accuracy or completeness of any description, photograph or statement contained in this manual. Printed colors and specifications may vary slightly from product. Products from Musikhaus Kirstein GmbH are only sold through authorized dealer. Distributors and dealers are not agents of Musikhaus Kirstein GmbH and have no authority to bind Musikhaus Kirstein GmbH legally in any way. This manual is protected by copyright. Any copying or reprint, even in excerpts, is only allowed with written consent of Musikhaus Kirstein GmbH. The same applies to reproduction or copying of images, even in altered form.

Musikhaus Kirstein GmbH

Bernbeurener Strasse 11

86956 Schongau

Telefon: 0049-8861-909494-0

Telefax: 0049-8861-909494-19

www.kirstein.de

 **KIRSTEIN.de**