



XDrum DD 520 Digital Drum



User manual

Congratulations!

Thank you for purchasing this digital drum set. The drum set has been Developed to act and play like a drum set but with greater ease. Before you use the instrument, we recommend you to read through this manual.

Taking care of Your Digital Drum Set

Location

- Do not expose the unit to the following Conditions to avoid deformation, discoloration or more serious damage.
- Direct sunlight.
- High temperature (near a heat)source, Or in car during the day time).
- Disconnect all cables before moving

Power Supply

- make sure to use the suitable AC adaptor, and also make sure the ac outlet voltage at your country matches the input voltage specified on the AC AC adaptor's label.
- Turn the power switch OFF When the Instrument is not in use.
- An AC adaptor should be unplugged from the AC outlet if the instrument is not be used for an extended period of time.
- Unplug the AC adaptor during electric storms.
- Avoid plugging the AC adaptor into
- The same AC outlet as appliance with high power consumption, such as electric heaters or ovens. Also avoid using multi-plug adaptors since these can result in reducing the sound quality, operation errors, and possibly damage.

Turn Power OFF When Making Connections

- To avoid damage to the instrument and other devices to which it is Connected, turn the power switches of all related device OFF prior to connecting or disconnecting cables.

Handling and Transport

- Never apply excessive force to the controls, connectors or other parts of the instrument.
- Always unplug cables by gripping the plug firmly, but not pulling on the cable.
- Disconnect all cables before moving The instrument.
- Physical shocks caused by dropping, bumping, or placing heavy objects on the instrument can result in scratches more serious damage.

Cleaning

- Clean the unit with a dry soft cloth.
- A Slightly damp cloth may be used to Remove stubborn grime and dirt.
- Never use cleaners such as alcohol or thinner.
- Avoid placing vinyl object on top of The unit (uinyln can stick to and discolor the surface).

Electrical Interference

- This instrument contains digital circuitry and may cause interference if placed too close to radio or television receivers. If this occurs, move the instrument further away from the affected equipment.

Content:

Assembly	1
connection	2
connect pad and module.....	2
Panel description	3
Front pane.....	3
Rear panel/top	4
Side panel	5
LCD initial interface.....	5
Connect with external devices	6
Connect audio system&drum amp.....	6
Connect heaphone.....	6
Connect MP3 or CD player.....	6
Connect PC	6
Connect MIDI keyboard	7
Power supply and switch.....	7
Performing	8
Select drum kit	9
Performing	9
Playing the pads.....	9
Adjust pad sensitivity	10
Use metronome	11
Adjust click	12
Adjust click tempo.....	12
Edit/save a drum kit.....	12
Change pad voice	13
Change pad volume.....	13
Change pad L/R CH pan.....	13
Change MIDI output pitch.....	13
Save setting to user drum kit.....	13
Adjust pad sensitivity.....	13
Adjust pad curve.....	13
Adjust pad threshold.....	14
Eliminate pad crosstalk.....	14
Adjust pad effect.....	15
EQ setting.....	15
Ambience setting.....	15
User drum kit default setting.....	15
Pad parameter setting instruction	16
DEMO SONG playing.....	16
Select DEMO SONG.....	16
Adjust volume of accompaniment& pad.....	17
Mute drums of DEMO SONG.....	17
Adjust DEMO SONG tempo	17
Recording your own performance	17
Recording quickly.....	17
Play back variation.....	18
LOGO backlight function.....	18
Create your own drum kit	18
Relative information of drum kit.....	18
How to select a drum kit.....	18
Change pad voice	19
Change pad volume.....	19
Change pad pan of L/R channel	20
Change MIDI output pitch.....	20
Adjust pad sensitivity.....	20
Adjust PAD CURVE.....	20
Adjust pad threshold	21
Eliminate pad crosstalk.....	21
Adjust pad effect	22
MIDI setting.....	22
MIDI connection.....	22
Connect external audio sourc.....	23
Used as audio source device	23
MIDI list.....	24
Trouble shooting	26
Audio source parameter.....	26
Drum kit list	27
Voice list	28
DEMO SONGlist	32

Drum stand assembly

1. Set up the drum stand. (Different model has different configuration)
2. Put the long cymbal tube/short cymbal tube/L shape pad rod into the drum stand.

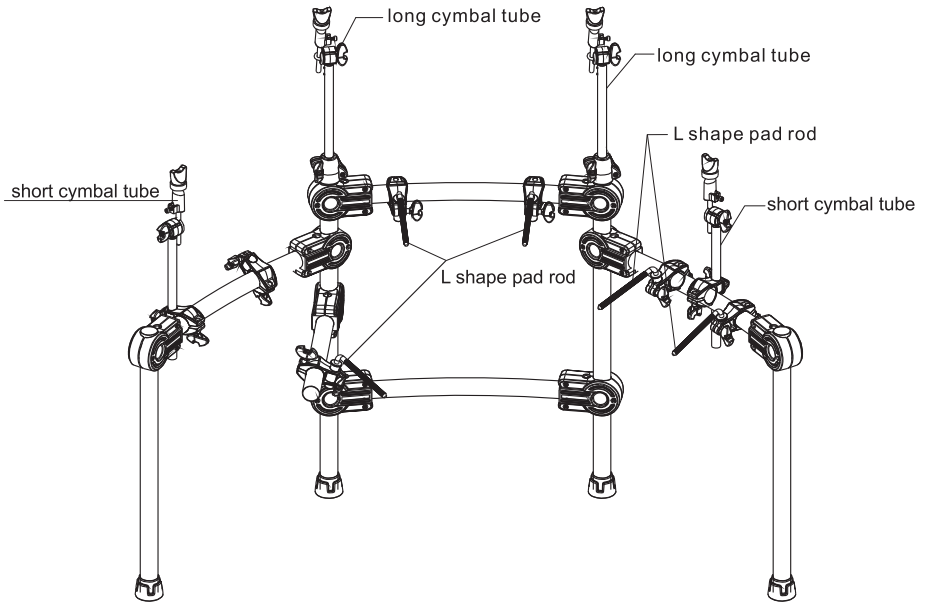

3. Put the pads/cymbal/module to the relative position.

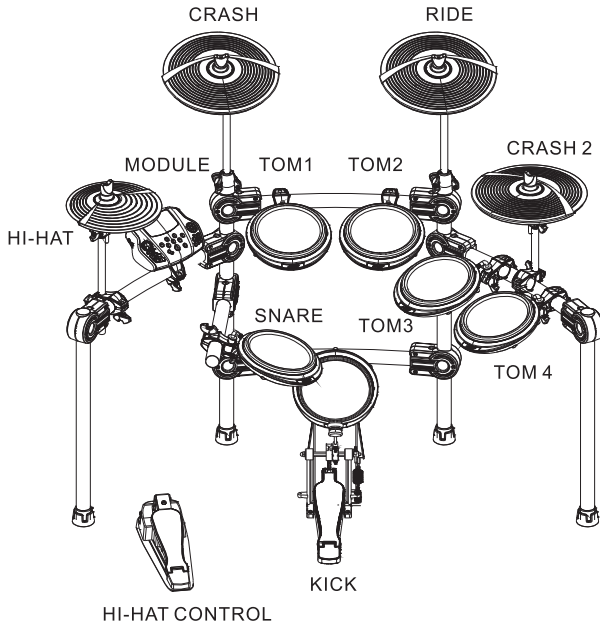

Connection

Note

When connecting the pads and audio source box, turn off the power switch please, otherwise it will destroy the drum kit

Connecting the pads and module

1. DD-520 configuration:

DD-520 configuration: TOM1-3(dual CH), SNARE(dual CH), KICK(mono), HI-HAT (mono), RIDE(dual CH), CRASH(dual CH), HI-HAT CTRL

DD-520 configuration: TOM1-4(dual CH), SNARE(dual CH), KICK(mono), HI-HAT (mono), RIDE(dual CH), CRASH1 and CRASH2(dual CH), HI-HAT CTRL

Use the pad cable and connect one end with pad and the other with DSP of module, then tight it.

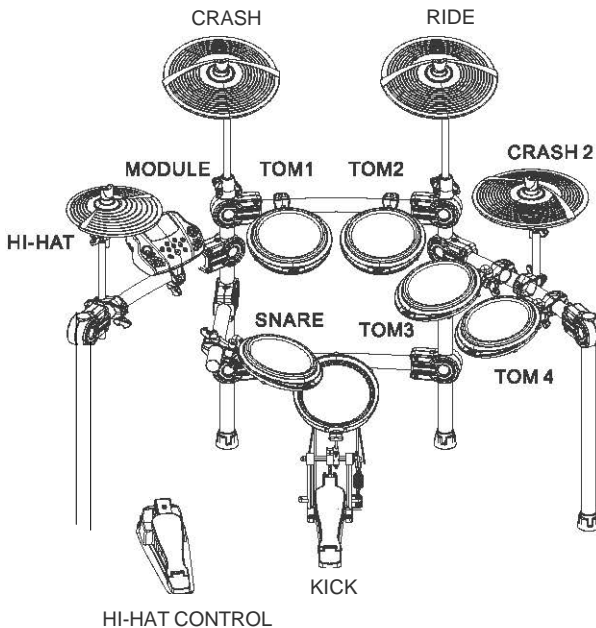

Panel Description

Front panel

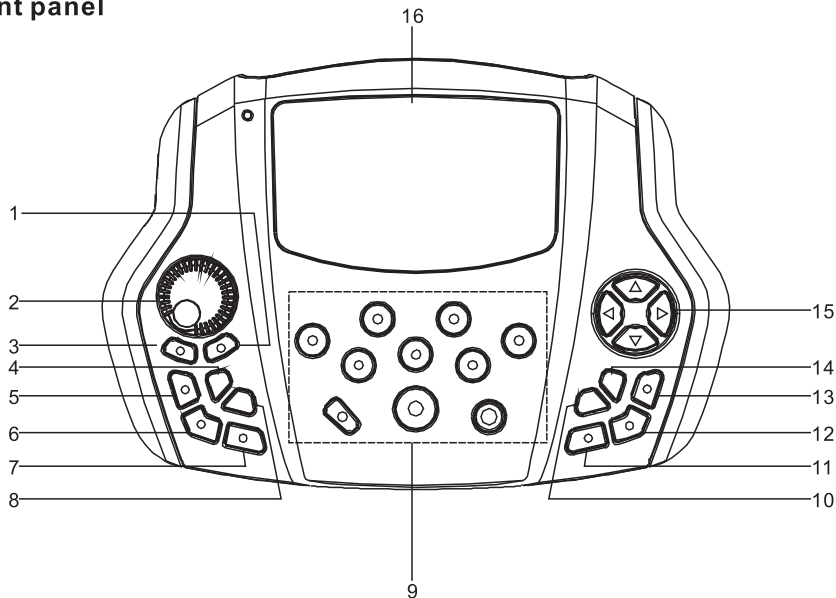

1. SAVE

Start or stop playing DEMO SONG

2. MASTER VOLUME

Adjust the volume of phone and line output.

3. START/STOP

Start or stop playing DEMO SONG

4. TEMPO

Enter into the tempo setting quickly.

5. RECORD

Record the drum set sound.

6. VOICE PLAY

Play/pause the recorded sound.

7. CLICK

Play the metronome.

8. SONG

Enter into DEMO SONG setting quickly.

9. Pad indication

Indicates the working pad or tests the pad, or set the pad parameter.

10. CANCEL

Cancel the operation or go back to the former menu.

11. KIT

Switch to drum kit quickly.

12. DRUM OFF

It mutes the DEMO SONG.

13. VOICE

Quickly switch to voice setting.

14. SET UP

Set up metronome/drum/DEMO SONG etc.

15. Direction key

▲ ▼:Menu selection

◀ ▶:change the parameter

(hold the button to change the value continuously.)

16. LCD

Displays the menu content.

Rear panel connection

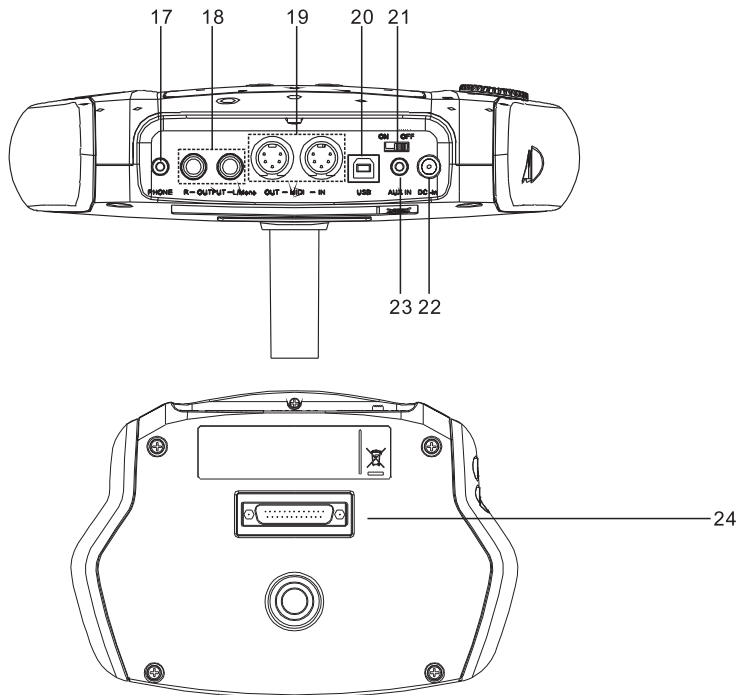

17. PHONE

Headphone output connector.

18. -OUT PUT- L/mono R

L/R channel, connect with the output connector of audio system or drum amplifier.

19. IN--MIDI--OUT

Connect with the connector of external device which has MIDI.

20. USB

Connect with PC connector (MIDI in/out)

21. POWER SWITCH

It turns on/off the drum.

22. DC IN

Adaptor connector, 9V DC.

23. AUX IN

External stereo input connector, e.g.

24. PAD connection

Pad signal input connector, including:
KICK, TOM1--3, SNARE, RIDE, CRASH,
HI-HAT CTRL

Side button

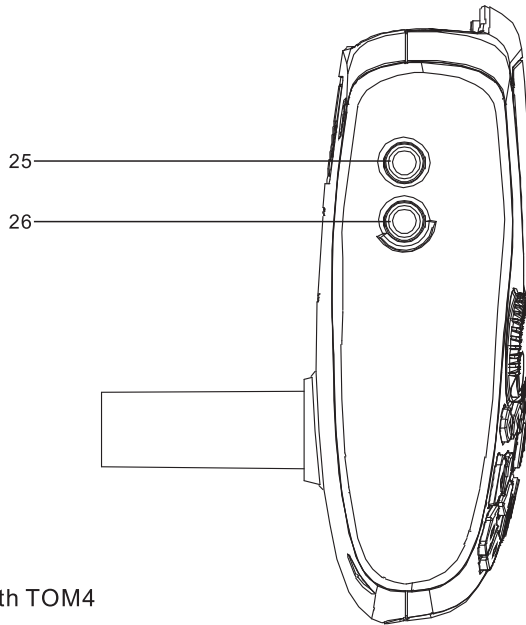

25. TOM4

It connects with TOM4

26. CRASH2

It connects with CRASH2

LCD initial interfaces

- 1).**CLICK=4/4**(default value when on):metronome parameter indication
- 2).**TEMPO=100**(default value when on):tempo parameter indication
- 3).**KIT01 POP01**(default value when on): drum kit indication
- 4).**SONG01**(default value when on): demo song indication
- 5).**DRUM ON**(default value when on): mutes the drum sound of demo song.

CLICK=4/4	TEMPO=100
KIT01 POP01	
SONG01	DRUM ON

Connect with external devices

Connect to audio system or amplifier

When connecting with audio system or drum amplifier, use a cable to connect with L/mono R of the audio system and the drum amplifier.

Note:

- 1).Connect with L/mono connector when connecting with mono audio device.
- 2).Connect with L/mono and R connector when connecting with stereo audio device.
- 3).The volume is controlled by the master volume knob of drum kit and of the audio device.

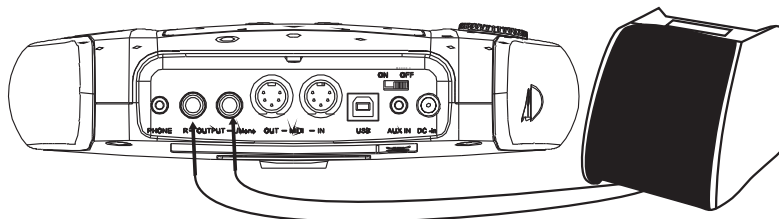

Connecting the headphones

The audio source box has 1/4" headphone connector(if use a 1/8" headphone ,use an adaptor), the volume is controlled by the volume knob of the audio source box.

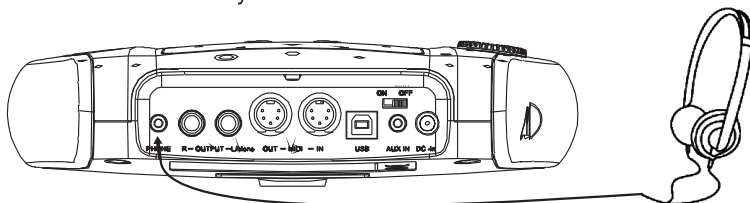

Connect to MP3 or CD player

Connect the output of MP3 or CD player or other audio sources with AUX.IN connector. The input signal can be mixed with the drum signal, strike the pads according to the rhythm of the input signal.

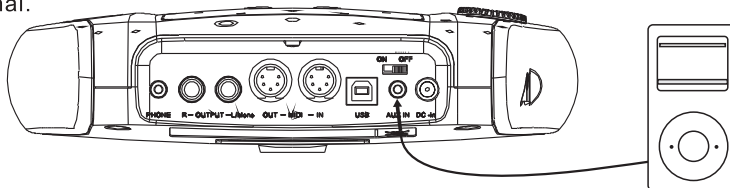

Connect to a computer

1. Connect the computer via USB Receive and send MIDI signal.

2. Connect the computer via MIDI port

MIDI IN: receiver MIDI signal of computer or other devices.

MIDI OUT: send pad performance signal to external MIDI devices or computer.

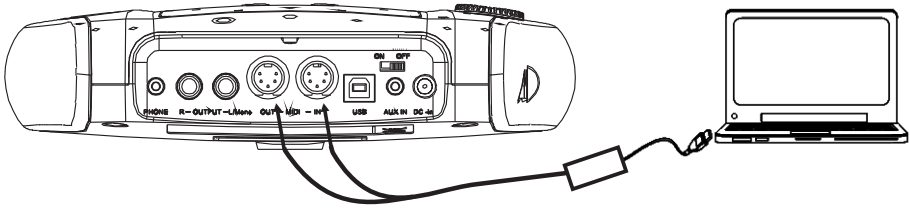
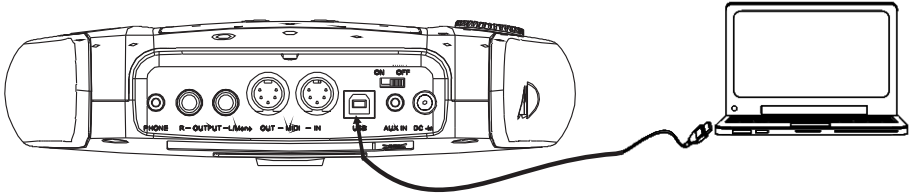

Connect with a MIDI keyboard

MIDI connector: If you're using an external MIDI keyboard or pads to control the digital drum, make connections as shown. Here, it is used as a sound module.

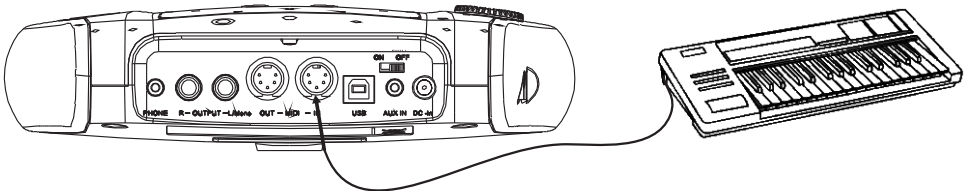

Power supply and switch

Make sure the power is switched OFF. Connect the power adaptor to the DC IN jack on the side panel. After confirming that all connections have been completed, rotate the volume knob to the left (minimum volume level) before switching the power on. Set the power switch to the “ON” position. The KIT indicator on LCD will light up and the display will show kit number 01 pop 01.

Note:

Make sure the power is switched OFF when connecting the drum module with external devices.

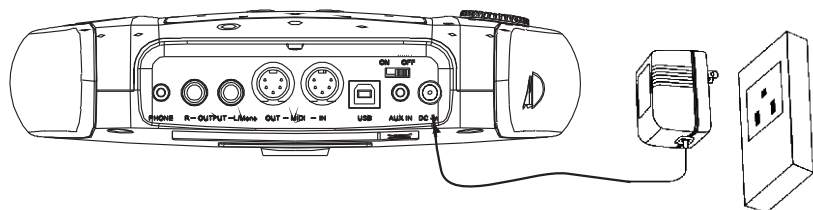
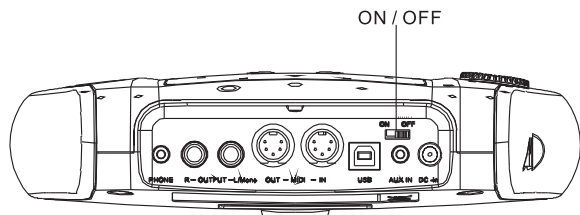

Basic operating

Selecting a drum kit

after powering up, the digital drum will be in kit menu (kit indicator on). the display should look like the following figure. there are 3 ways to activate the drum kit menu:

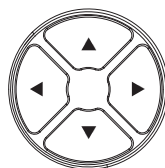
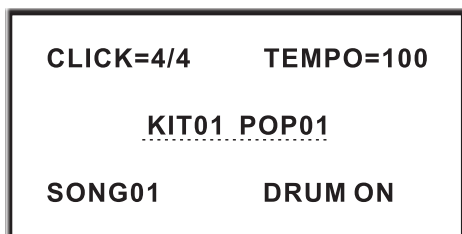

1. Use the direction key ◀ ▶ to select drum kit. 41 sets of drum kits in all.
 20 sets of preset drum kits: KIT01---26
 15 sets of user drum kits: USER01---15
2. Pressing the Pad Select buttons allows you to preview the current kit (fixed tempo).

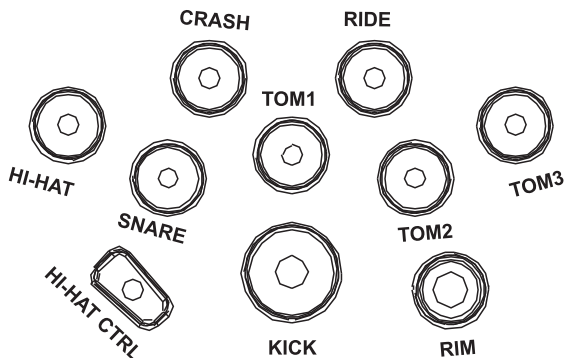

3. Hit the pads to play the current kit.

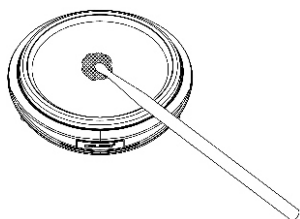

Playing the pads

Similar to an acoustic drum kit, the digital drum responds differently to various playing techniques and dynamics. All the pads sense the striking force, and some voices change tone depending on the striking force.

Drum pad and rim shot

The digital drum pad detects head and rim shots (rim shots are different from the pad shots).

Note:

1. SKD200/210/220/230: SNARE and TOM1-TOM4 are dual channels. Both are rim shot.
2. RIDE: it delivers RIDE BELL sound when hit strongly, and RIDE CYMBAL sound when hit slightly.
3. SNARE delivers one sound when hit the pad and rim at the same time.

Cymbal bow shot and choke

CRASH and RIDE have the bow shot and choke, e.g. hit the cymbal or the rim then hold the rim to CRASH or RIDE sound.



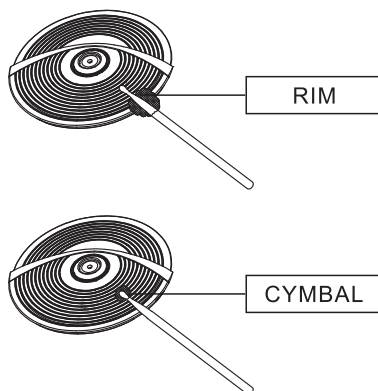
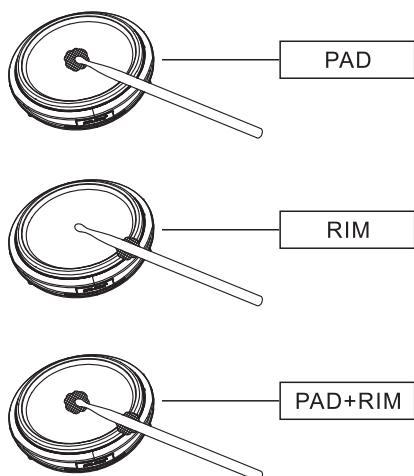

HI-HAT

The Hi-Hat sound varies depending on the position of the Hi-Hat pedal:

Open Hi-Hat: Strike the Hi-Hat pad without pressing the pedal.

Closed Hi-Hat: Strike the Hi-Hat pad with the pedal pressed completely down.

Pedal Close: Press the pedal completely down without striking the pad.

Half-open Hi-Hat: Strike the Hi-Hat pad with the pedal pressed halfway down

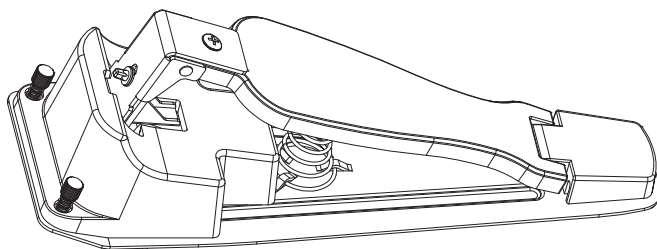

Performing

Adjusting the sensitivity of a pad

Adjust the sensitivity according to the desired style and dynamic range

1. Press [KIT] button to enter into the drum kit (KIT LED flashes once)

2. Press [SET UP] button to enter drum setting, use the direction key ▲▼ to Select: PAD SENSITIVITY,

3. When PAD SENSITIVITY flashes, press [SET UP] to enter pad sensitivity setting.
4. Strike the relative pad or press the pad button to adjust sensitivity.
5. Use the direction key ▲ ▼ to select the parameter, and use the keys ◀ ▶ to change the parameter.
 - 1). PAD CURVE adjust pad curve parameter
 - 2). THRSILD adjust pad threshold
 - 3). CROSSTALK delete pad crosstalk
6. After changing the above parameters properly, press [SAVE] to save the changing.

Note

 1. refer to the pad setting to set pad parameter in details.
 2. press [CANCEL] to exit the setting
 3. When adjusting the parameters, press [SET UP] to reset.

(For details refer to :edit and save user drum kit)

DRUM PAD SETTING
 PAD SENSITIVITY
 RELOAD FAC SET
 EFFECT

PAD HIHAT
 PAD CURVE=2
 THRSILD=4
 CROSSTALK=2



Performing

Using the metronome

1. User can use the [CLICK] button to turn on/off metronome.
 2. use the direction key ▲ ▼ to select the metronome items.
 To reset.
- (For details refer to :edit and save user drum kit)

CLICK=4/4 TEMPO=100

KIT01 POP01

SONG01 DRUM ON

Adjusting the click

3. When the metronome plays at the click and tempo, such as the LCD displays, the CLICK flashes, user can use the direction key ◀ ▶ to change click.

(1/4, 2/4, 3/4, 4/4, 5/4, 6/4, 7/4, 8/4, 9/4, 1/8, 2/8, 3/8, 4/8, 5/8, 6/8, 7/8, 8/8, 9/8, 1/2, 2/2, 3/2, 4/2, 5/2, 6/2, 7/2, 8/2, 9/2)

4. In the tempo item, press [SET UP] button to set click tone parameters.

CLICK VOICE OPTION
VOICE TYPE=01
VOICE VOL=100

- 1).VOICE TYPE=01 user can adjust the voice type (01---03)
- 2).VOICE VOL=127 user can adjust the voice volume (000---127)
- 3).When adjusting parameters, press [SET UP] button to reset.

User can adjust the click tempo. When playing DEMO SONG, press tempo and playing tempo (030---300)

- 1.Press [TEMPO] to adjust tempo speed.
- 2.Use the direction key ◀ ▶ to change tempo speed.
- 3.When changing parameters, press [SET UP] button to reset.

CLICK=4/4 TEMPO=100
KIT01 POP01
SONG01 DRUM ON

Edit and save a drum kit

In the drum kit menu, user can change parameter according to the playing style then save it.

- 1.Press [KIT] to select the drum kit
- 2.Use the direction key ◀ ▶ to switch to the desired drum kit to edit.

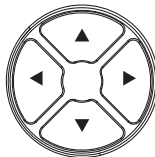

- 3.Press [SET UP] to enter drum pad setting, and DRUM PAD SETTINGFlashes.

1. Select pad via pad indication button or hit the pads.
2. Press [SET UP] again to enter tone parameter setting.
6. Use direction key ◀▶ to select tone.
(Note: refer to the tone list for tone)

VOICE=ESN_04
VOLUME=080
PAN=084
MIDI PITCH=044

Change the pad volume

7. Use direction key ▲▼ to select VOLUME item.
8. Use direction key ◀▶ to change volume.

Change pad L/R channel position

9. Use direction key ▲▼ to select PAN
10. Use direction key ◀▶ to change L/R Channel position.
(GM standard:000---127)

SAVE CHANGE
FOR USER01
PRESS SAVE FOR YES
PRESS CANCEL FOR NO

Change MIDI output pitch value

11. Use direction key ▲▼ to select MIDI PITICH
12. Use direction key ◀▶ to change MIDI output pitch value(000---127)
(when adjusting parameter, press [SET UP] button to reset all parameters back to default status)

Save setting to user drum kit

1. Press [SAVE] to save setting to user drum kit.
2. Use direction key ◀▶ to select user drum kit(01---15)
3. Press [SAVE] button to save

Adjusting the pad sensitivity

1. Use the direction key ▲▼ to switch to PAD SENSITIVITY
2. Press [SET UP] to enter pad sensitivity setting.

DRUM PAD SETTING
PAD SENSITIVITY
RELOAD FAC SET
EFFECT

Adjusting pad curve

Pad curve is relative to the pad dynamic signal.
(Default:CURVE2)

```
PAD HIHAT  
PAD CURVE=2  
THRSHLD=4  
CROSSTALK=2
```

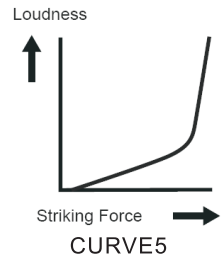
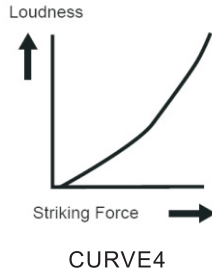
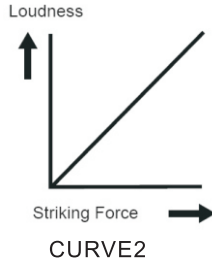
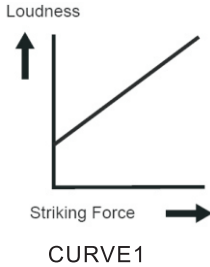

Adjusting the pad threshold

threshold: the minimum force to trigger a pad signal.

Setting a high threshold, the pad needs a strong force to generate a signal. This can avoid accidental response, e.g. other device or pad generate unnecessary signal.

Setting a low threshold, the pad needs a weak force to generate a signal.

User can adjust threshold based on external condition and performing style.

Threshold range:1---8

Deleting crosstalk of the pads

When two pad are close, hitting one pad can cause the other pad generates a signal. This crosstalk can be deleted by setting a high parameter of the other pad.

Note

If two close pads are hit at the same time and one pad threshold is too high, the high threshold pad does not generate a signal, so take care to set threshold to avoid crosstalk.

Adjusting pad effect

1. Use the direction key ▲ ▼ to switch to EFFECT
2. Press [SET UP] to enter pad effect setting.

DRUM PAD SETTING
PAD SENSITIVITY
RELOAD FAC SET
EFFECT

EQ setting

3. Use the direction key ▲ ▼ to select EQ type.
4. Use the direction key ◀ ▶ to change EQ value.
HI GAIN=13(default) range:01---25
MID GAIN=15(default) range:01---25
LOW GAIN=18(default) range:01---25

HI GAIN=13
MID GAIN=15
LOW GAIN=18
AMBIENCE=OFF

Ambience setting

5. Use the direction key ▲ ▼ to select AMBIENCE
6. Use the direction key ◀ ▶ to switch AMBIENCE
AMBIENCE=OFF
AMBIENCE=01
AMBIENCE=02
(When adjusting parameters, press [SET UP] to reset
All parameters to the default status.)

HI GAIN=13
MID GAIN=15
LOW GAIN=18
AMBIENCE=OFF

Go back to default setting

1. Use the direction key ▲ ▼ to select RELOAD FAC SET
2. press[SET UP]to go back to the default setting.
3. Use the direction key ◀ ▶ to select saved drum kit.
e.g.FOR USER01
4. Press [SET UP] to go back to the default setting
5. Press [CANCEL]to cancel the default setting

RELOAD SETTING
FOR USER01
SET UP FOR YES
CANCEL FOR NO

Instruction for pad parameter setting

1. Pad curve

The curve is relative to the pad dynamic signal.
(default:CURVE2)

CURVE 1:very low dynamic response, high volume. If used to trigger the pads,the curve is flat.
CURVE2: the standard setting, during playing or when volume changes, it generates maximum natural signal.

CURVE3: compared to CURVE2, weak force generates relatively big change.

CURVE4: compared to CURVE2, strong force generates relatively big change.

CURVE5: compared to CURVE2, strong force generates very big change.

2. Threshold

Threshold: the minimum force to generate a pad signal.

The high threshold needs strong force to generate pad signal. Low threshold needs weak force to generate pad signal.

Setting threshold needs to refer to playing style and external condition.

Threshold range: 1---8

3. Crosstalk

If the crosstalk is too high, weak force is hard to trigger the pad. If the crosstalk is too low, it is easy to lead to crosstalk.

4. About saving

All the changes to the preset drum kit can not be saved in the preset drum kit, but in the user drum kit.

DEMO SONG playing

Select playing DEMO SONG

1. Press [SONG] to switch to DEMO SONG menu or use the direction Key ▲▼ to select SONG01
2. Use the direction key ◀▶ to Select the preset DEMO SONG
3. Press [START/STOP]to play the selected songs

CLICK=4/4

TEMPO=100

KIT01 POP01

SONG01

DRUM ON

(refer to DEMO SONG LIST for the DEMO SONG

Adjusting DEMO SONG accompaniment and drum volume

4. press [SET UP] to enter accompaniment and drum volume setting.

ACC VOLUME: adjusting accompaniment volume.

Use the direction key ◀ ▶ to adjust

DEMO SONG accompaniment volume.

DRUM VOLUME: adjusting drum volume. Use the

direction key ◀ ▶ to adjust DEMO SONG drum volume.

ACC VOLUME=090

DRUM VOLUME=090

Mute the Drums of DEMO SONG

1. when playing DEMO SONG and you want to mute the Drums of the DEMO song, use the direction key ▲ ▼ to select DRUM ON, then DRUM ON flashes.

2. Use the direction key ◀ ▶ to switch to DRUM OFF

CLICK=4/4

TEMPO=100

KIT01 POP01

SONG01

DRUM ON

Adjusting DEMO SONG tempo

When playing, use the direction key ◀ ▶ to adjust DEMO SONG tempo.

CLICK=4/4

TEMPO=100

KIT01 POP01

SONG01

DRUM ON

Recording your performance

You can record pad performances and the Drums as accompaniment.

Recording quickly

1. Press [RECORD]. Recording LED lights up, and the Metronome turns on automatically.

2. Strike pad to record or record the drum section of the song.

3. Press [RECORD] again to stop recording.

Recording LED lights off. Your performance or the drum section has been recorded.

CLICK=4/4

TEMPO=100

KIT01 POP01

SONG01

DRUM ON

(Note: when recording, you need to turn on DRUM ON, that is to switch DRUM OFF to DRUM ON)

Playing back the recorded performance

1. Press [VOICE PLAY].LED flashes once. It plays the recorded performance.
2. Press [VOICE PLAY] again to stop playing.
3. If you are unsatisfied with the recorded performance, press [RECORD] to record once again.
(Note: it can record the performance but can not save. This means the recorded performance will cover the former recorded performance)

Creating your own drum kit

Relative information of drum kit

In the drum kit menu, user can select drum kit to play, or can edit the pad tone and parameter, e.g. tone, volume, L/R channel pan, MIDI output pitch, etc.

This digital drum has 41 set drum kit for performance: 26 preset drum kits:KIT01---26
15 user drum kit:USER01---15

How to select a drum kit

If the drum kit menu does not appear, press [KIT] to enter drum kit menu. [KIT]LED flashes once; Or use the direction key ▲▼ to select drum kit.LCD displays the current drum kit number.

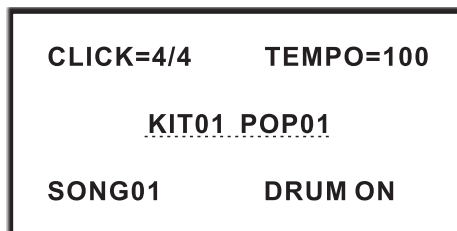

In drum kit menu, user can set the parameters,

1. Press [SET UP] to enter drum kit parameter setting interface.
2. Select DRUM PAD SETTING to enter drum kit parameter setting.
3. Press [SET UP] again to enter pad parameter setting interface.
4. Use the pad button to select pad or strike the relative pad.
Note: user can choose via hitting pad rim and the cymbal rim
5. User can select the pad parameter and change parameter via direction key (refer to the following: change pad tone/change volume/change pan/change MIDI out pitch
6. After setting, press SAVE to save the user drum kits. User can change the drum kits via direction keys. After selection, press SAVE once again to save the change or press CANCEL to cancel the change.

DRUM PAD SETTING
PAD SENSITIVITY
RELOAD FAC SET
EFFECT

VOICE=ESN_04
VOLUME=080
PAN=084
MIDE PITCH=046

SAVE CHANGE
FOR USER01
PRESS SAVE FOR YES
PRESS CANCEL FOR NO

Change pad voice

1. Select the pad via pad button or strike the pad directly.
2. Use the direction key ◀ ▶ to select voice.
(Note: refer to the voice list for voice)

VOICE=ESN_04
VOLUME=080
PAN=084
MIDI PITCH=046

Create your own drum kit

Change pad volume

1. Use the direction key ▲ ▼ to select VOLUME
2. Use the direction key ◀ ▶ to change volume.

VOICE=ESN_04
VOLUME=080
PAN=084
MIDI PITCH=046

Change pad pan of L/R channel

1. Use the direction key ▲▼ to select PAN
2. Use the direction key ◀▶ to change the pan of L/R channel.
(GM standard:000---127)

```
VOICE=ESN_04  
VOLUME=080  
PAN=084  
MIDI PITCH=046
```

Change MIDI output pitch

1. Use the direction key ▲▼ to select MIDI PITCH
2. Use the direction key ◀▶ to change MIDI output pitch value(000---127)
(when adjusting parameters, press[SET UP] To reset all parameters to default status)

```
VOICE=ESN_04  
VOLUME=080  
PAN=084  
MIDI PITCH=046
```

Making the setting for pads

1. Use the direction key ▲▼ to switch to PAD SENSITIVITY
2. Press [SET UP] button to enter pad sensitivity setting interface.

```
DRUM PAD SETTING  
PAD SENSITIVITY  
RELOAD FAC SET  
EFFECT
```

Adjusting PAD CURVE

The pad curve is relative to the pad dynamic signals.
(Default:CURVE2)

```
PAD HIHAT  
PAD CURVE=2  
THRSHLD=4  
CROSSTALK=2
```

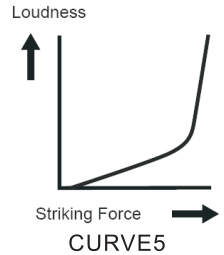
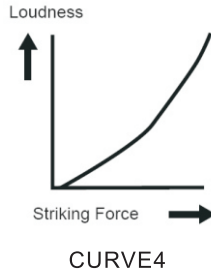
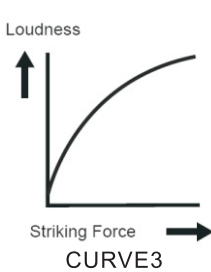
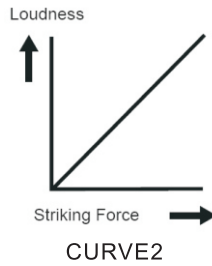
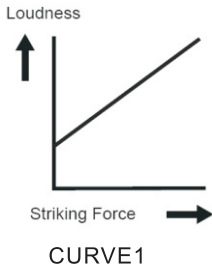

Adjusting pad threshold

Threshold: the minimum force to generate a pad signal.

A high threshold needs a strong force to generate a signal and this can avoid accidental response, e.g. unnecessary signal from other device or pad.

A low threshold needs weak force to generate a pad signal.

User needs to adjust threshold according to the performance style and condition.

Threshold range: 1---8

Eliminating crosstalk of pads

When two pads are close, striking one pad can trigger one signal of the close pad, so you can set the close pad to a high threshold to avoid crosstalk.

Note

If the threshold is too high, and you strikes two pads at the same time, the weak force does not trigger a signal of a pad with high threshold, so set the threshold carefully.

Adjusting pad effect

1. Use the direction key ▲ ▼ to switch to EFFECT
2. press [SET UP] to enter pad effect setting interface

EQ setting

3. Use the direction key ▲ ▼ to select EQ type.
4. Use the direction key ◀ ▶ to change EQ value.

DRUM PAD SETTING
PAD SENSITIVITY
RELOAD FAC SET
EFFECT

HI GAIN=13(default) range:01---25
MID GAIN=15(default) range:01---25
LOW GAIN=18(default) range:01---25

HI GAIN=13
MID GAIN=15
LOW GAIN=18
AMBIENCE=OFF

Ambience setting

5. Use the direction key ▲ ▼ to select AMBIENCE
6. Use the direction key ◀ ▶ to switch ambience effect

AMBIENCE=OFF
AMBIENCE=01
AMBIENCE=02

(when adjusting parameters, press [SET UP] button to reset all parameters to the default status)

HI GAIN=13
MID GAIN=15
LOW GAIN=18
AMBIENCE=OFF

MIDI setting

This device is compatible with various MIDI devices. When it is used as trigger device or audio source, it is compatible with GM standard, and can be used with many sequencer software

MIDI connection

MIDI IN: inputs MIDI signal when connecting with external MIDI device

MIDI OUT: outputs MIDI signal when connecting with external MIDI device

USB: standard USB2.0 interface. connect with USB of MIDI device or PC. The operation system has relative driver without the need to install again. Compatible with the PC system, e.g. Xp, Win7,Vista,Mac OSX . After connection, the system recognizes this device as USB AUDIO DEVICE. (USB only used for MIDI connection)

Note: when USB connects with PC, all MIDI data can transfer via USB

Connecting with external audio device

This device automatically via channel 10 transfers drum signal to other MIDI device, including notes, forces, pedal performance, etc.

(Note: Song playback data and metronome notes are not transferred)

Record your performance with external sequencer

1. Connect with external sequencer or PC via MIDI OUT or USB interface.
2. Use the sequencer or the software to set channel 10 as a device to start recording.
3. Play the drum pads.
4. Stop performance and recording. Playback the recording.

Setting MIDI note number to be transferred/received by each pad

1. Press VOICE button to enter the VOICE menu.
2. Strike the relative pad, use direction key to select MIDI PITCH
3. Use the left/right key to MIDI value for a pad.
4. Press save button to save USER drum kit.

Default factory setting as below:

TRIGGER	MIDI NOTE	TRIGGER	MIDI NOTE	TRIGGER	MIDI NOTE
KICK	36	TOM1 RIM	56	TOM3 RIM	63
SNARE	38	TOM2	45	TOM4	41
SNARE RIM	37	TOM2 RIM	64	TOM4 RIM	62
TOM1	47	TOM3	43	CRASH	49
CRASH RIM	55	RIDE RIM	57	CRASH2 RIM	52
RIDE	51	CRASH2	59	HI-HAT CTRL	42
HI-HAT O	46	HI-HAT P	44		

Change pad voice

When MIDI OUT or USB cable is connected with MIDI device or sequencer, it receives MIDI output signal and this device can play this signal. The voice changes while drum kit changes. This device has most part of the GM drum kit. User can create the own drum kits for performance.

Refer to the MIDI list for the support and limitation

MIDI list

FUNCTION		TRANSMITTED	RECOGNIZED	REMARKS
BASIC CHANNEL	DEFAULT	10 Ch	1---16	
	CHANGED	x	x	
MODE	DEFAULT	x	x	
	MESSAGES	x	x	
	ALTERED	x	x	
NOTE NUMBER	TRUE VOICE	***** *****	0---127 0---127	
VELOCITY	NOTE ON	○ 99H.V=1---1	○	
	NOTE OFF	x	○	
AFTER TOUCH	KEY'S	x	x	
	CH'S	x	x	
PITCH BEND		x	x	
CONTROL CHANGE	0	x	○	BANK SELECT
	1	x	x	MODULATION
	5	x	x	PORTAMENTO TIME
	6	x	○	DATA ENTRY
	7	x	○	VOLUME
	10	x	○	PAN
	11	x	x	EXPRESSION
	64	x	○	SUSTAIN PEDAL
	65	x	x	PORTAMENTO ON/OFF
	66	x	x	SOSTENUTO PEDAL
67	x	x	SOFT PEDAL	

	80	x	○	REVERB PROGRAM
	81	x	○	CHORUS PROGRAM
	91	x	○	REVERB LEVEL
	93	x	○	CHORUS LEVEL
	120	x	○	ALL SOUND OFF
	121	x	○	RESET ALL CONTROLLERS Controllers
	123	x	○	ALL NOTES OFF
		x	○	
		x	0-127	
System Exclusive		x	x	
System	:Song Position	x	x	
Common	:Song Select	x	x	
	:Tune	x	x	
System	:Clock On/Off	○	x	START AND STOP ONLY
Real Time	:Commands		x	
Aux	:Local	x	x	
	:All Notes Off	x	x	
Message	:Active Sensing	x	x	
	:Reset	x	x	

Trouble shooting

Problem	Reason or solution
No sound	Confirm the volume is not turned off
Pad had no sound	1.confirm the correct connection of pad 2.confirm pad volume is not set to 0
Metronome has no sound	Confirm the metronome volume is not set to 0
DEMO SONG has no sound	Confirm DEMO SONG volume is not set to 0

Audio source parameters

Polyphony 64

Drum kits:

26 preset drum kits:KIT01---26

15 user drum kits:USER01---15

Voice

458 kinds of voices(DRUMS, PERCUSSION ,SFX)

(6 kinds of SNARE COMBO)

Effects: ambience setting,3 kinds of EQ setting

Sequencer

DEMO SONG:20 pcs

Recording: real time recording, can not be saved

Tempo:030---300

Display:LCD blue backlight, LOGO backlight color: red/green/blue adjustable

Connection

9 stereo in connectors, headphone stereo out connectors (1/8"),AUX IN stereo connector (1/8"),
2 link connectors(1/8" TOM4,CRASH2),audio output connector(1/8" L/mono R),USB,MIDI IN/MIDI
OUT

Power supply:DC 9V inside+ outside-

Dimension:232(L)*162(W)*121(H)

Weight: about 0.5kg

Drum kit list

No	Preset drum kit	No	User drum kit
KIT01	POP1	USER01	POP1
KIT02	POP2	USER02	POP2
KIT03	POP3	USER03	POP3
KIT04	POP4	USER04	POP4
KIT05	POP5	USER05	POP5
KIT06	POP6	USER06	POP6
KIT07	ROCK1	USER07	ROCK1
KIT08	ROCK2	USER08	ROCK2
KIT09	ROCK3	USER09	ROCK3
KIT10	METAL1	USER10	METAL1
KIT11	METAL2	USER011	METAL2
KIT12	METAL3	USER12	METAL3
KIT13	FUNK1	USER13	FUNK1
KIT14	FUNK2	USER14	FUNK2
KIT15	FUNK3	USER15	FUNK3
KIT16	LATIN1		
KIT17	LATIN2		
KIT18	JAZZ01		
KIT19	JAZZ02		
KIT20	BRUSH		
KIT21	ORCH		
KIT22	DANCE1		
KIT23	DANCE2		
KIT24	EAST1		
KIT25	EAST2		
KIT26	PERC		

Voice list

ACOUSTIC BASS DRUM

No	Name
005	KICK1
006	KICK2
007	KICK3
008	KICK4
009	KICK5
010	KICK6
011	KICK7
032	JAZZ_BD1
033	JAZZ_BD2
040	ORCHBD1
041	ORCHBD2
042	ORCHBD3
407	KICKC1
408	KICKC2
409	KICKC3
410	KICKC4

ELEC. BASS DRUM

No	Name
001	EKICK01
002	EKICK02
003	BD_DEEP1
004	BD_DEEP2
012	DNC_BD1
013	DNC_BD2
014	LO_BD
015	SYNBD01
016	SYNBD02
017	SYNBD03
018	EKICK01
019	EKICK02
020	EKICK03
021	EKICK04
022	EKICK05
023	EKICK06
024	EKICK07
025	EKICK08
026	EKICK09
027	EKICK10
028	ETTBD
029	HARDBD
030	HI_KICK
031	HRTBEAT
034	LOFI_BD
035	LONG_BD1

036	LONG_BD2
037	LONG_BD3
038	LT_BD1
039	NOISEBD
043	SPACEBD1
044	SPACEBD2
411	EKICKC1

ACOUSTIC SNARE

No	Name
085	BRSH_SN1
086	BRSH_SN2
102	FNK_SN1
103	FNK_SN2
104	HRD_BT1
105	HRD_BT2
106	JZ_SLP1
107	JZ_SLP2
108	JZ_SLP3
109	JZ_SLP4
110	ORCHSN1
111	ORCHSN2
112	ORCHSN3
113	SD_STK1
114	SD_STK2
115	SD_STK3
116	SD_STK4
117	SN_RIM
118	SN_STD
119	SNARE1
120	SNARE2
121	SNARE3
122	SNRIM
123	HV_SN
124	TITE_SN1
125	TITE_SN2
126	TITE_SN3
127	TITE_SN4
128	TITE_SN5
129	TRD_SN1
130	TRD_SN2
412	SNAREC1
413	SNAREC2
414	SNAREC3
415	SNAREC4
416	SNAREC5

418	SRIMC1
419	SRIMC2
420	SRIMC3
421	SRIMC4
422	SRIMC5

ELEC. SNARE

No	Name
087	SYNSN01
088	SYNSN02
089	SYNSN03
090	ESN_01
091	ESN_02
092	ESN_03
093	ESN_04
094	ESN_05
095	ESN_06
096	ESN_07
097	ESN_08
098	ESN_09
099	ESN_10
100	ESN_11
101	ESN_12
417	ESNAREC

SNARE COMBO

No	Name
401	SNCOMBO1
402	SNCOMBO2
403	SNCOMBO3
404	SNCOMBO4
405	SNCOMBO5
406	SNCOMBO6

ACOUSTIC HI-HAT

No	Name
045	CHH_STD
046	CHH1
047	CHH2
048	CHH3
049	CHH4
050	CHH5
070	LOOS_HH1
071	LOOS_HH2
072	LOOS_HH3

Voice list

073	LOOS_HH4
074	LOOS_HH5
075	LOOS_HH6
076	OHH_STD1
077	OHH_STD2
078	OHIHAT1
079	OHIHAT2
080	OHIHAT3
081	PHH_JZ
082	PHH1
083	PHH2
084	PHH3
423	CHHC1
424	CHHC2
425	CHHC3
427	OHHHC1
428	OHHHC2
429	OHHHC3
431	PHHC1
432	PHHC2

ELEC. HI-HAT No Name

051	SYNHH1
052	SYNHH2
053	SYNHH3
054	EHH01
055	EHH02
056	EHH03
057	EHH04
058	EHH05
059	EHH06
060	EHH07
061	EHH08
062	EHH09
063	EHH10
064	EHH11
065	EHH12
066	EHH13
067	EHH14
068	EHH15
069	EHH16
426	ECHHC1
430	EOHHC1
433	EPHHC1

ACOUSTIC TOM No Name

131	BRSH_T1
132	BRSH_T2
133	BRSH_T3
146	FLTM_STD
147	JZ_TOM1
148	JZ_TOM2
149	JZ_TOM3
150	TOM1
151	TOM2
152	TOM3
153	TOM4
154	TOM5
155	TOM6
156	TOM7
157	TOM8
158	TOMH_STD
159	TOML_STD
160	TOMM_STD
434	TOMC1
435	TOMC2
436	TOMC3
437	TOMC4
438	TOMC5
439	TOMC6
440	TOMC7
441	TOMC8

ELEC. TOM No Name

134	ETOM01
135	ETOM02
136	ETOM03
137	ETOM04
138	ETOM05
139	ETOM06
140	ETOM07
141	ETOM08
142	ETOM09
143	ETOM10
144	ETOM11
145	ETOM12
161	XEDRUM1

442	808T1
443	808T2
444	808T3

ACOUSTIC CYMBAL No Name

162	CRASH1
163	CRASH2
164	CRASH3
165	CRASH4
166	CRASH5
167	CRASH6
168	CRASH7
169	CRASH8
170	CRASH9
171	CRSH_JS1
172	CRSH_JS2
173	CRSHSTD1
174	CRSHSTD2
178	LT_CRSH1
179	ORCCYM1
180	ORCCYM2
181	ORCCYM3
182	ORCCYM4
183	RBLL_STD
187	RIDE_JZ1
188	RIDE_JZ2
189	RIDE_JZ3
190	RIDE_JZ4
191	RIDE_STD
192	RIDE1
193	RIDE2
194	SPLSH1
195	SPLSH2
445	ECRASHC1
446	ECRASHC2
447	ECRASHC3
448	ECRASHC4
449	ECRASHC5
450	ECRASHC6
451	ECRASHC7
452	ECRASHC8
453	ECRASHC9
454	SPLASHC

Voice list

455	RIDELC1
456	RIDELC2
457	RIDEHC1
458	RIDEHC2

ELEC. CYMBAL

No	Name
175	ECRASH1
176	ECRASH2
177	ECRASH3
184	REV_CYM1
185	REV_CYM2
186	REV_CYM3

PERCUSSION

No	Name
247	SNATCH
248	BLLTREE
249	CABASA1
250	CABASA2
251	CABASA3
252	CABASA4
253	CABASA5
254	CABASA6
255	CHKR01
256	CHKR02
257	CHKR03
258	CHKR04
259	CHKR05
260	CLAP1
261	CLAP2
262	CLKBLL
263	CLV
264	COWBLL01
265	COWBLL02
266	COWBLL03
267	COWBLL04
268	COWBLL05
269	COWBLL06
270	COWBLL07
271	COWBLL08
272	COWBLL09
273	COWBLL10

274	COWBLL11
275	COWBLL12
276	COWBLL13
277	HAGOGO1
278	HAGOGO2
279	HAGOGO3
280	HAGOGO4
281	HIBNGO01
282	HIBNGO02
283	HIBNGO03
284	HIBNGO04
285	HIBNGO05
286	HTMBL1
287	HTMBL2
288	HTMBL3
289	HTMBL4
290	HTMBL5
291	HTMBL6
292	HTMBL7
293	HTMBL8
294	HWBLK
295	L0_TMB21
296	L0_TMB3
297	L0_TMB4
298	L0_TMB5
299	L0_TMBL1
300	LAGOGO1
301	LAGOGO2
302	LAGOGO3
303	LAGOGO4
304	LGUIRO
305	LOBNGO01
306	LOBNGO02
307	LOBNGO03
308	LOBNGO04
309	LOCNGA01
310	LOCNGA02
311	LOCNGA03
312	LWBLK
313	LWHSL1
314	LWHSL2
315	MCUICA
316	MHCNGA01

317	MHCNGA02
318	MHCNGA03
319	MHCNGA04
320	MHCNGA05
321	MHCNGA06
322	MHCNGA07
323	MHCNGA08
324	MHCNGA09
325	MHCNGA10
326	MRCAS1
327	MRCAS2
328	MTRNGL
329	OCUICA
330	OHCNGA01
331	OHCNGA02
332	OHCNGA03
333	OHCNGA04
334	OHCNGA05
335	OHCNGA06
336	OHCNGA07
337	OHCNGA08
338	OHCNGA09
339	OHCNGA10
340	OHCNGA11
341	OPNTRNGL
342	SGUIRO
343	SWHSL1
344	SWHSL2
345	TMBRN1
346	TMBRN2
347	TMBRN3
348	TMBRN4
349	TMBRN5
350	VSLP01
351	VSLP02
352	VSLP03
353	CNBGONG
354	CNLCYMBL
355	CNLDRM1
356	CNLDRM2
357	CNSCYMBL
358	CNSDRM
359	CNSGONG

Voice list

360	DYRH01
361	DYRH02
362	DYRH03
363	DYRH04
364	DYRH05
365	INDNDRM1
366	INDNDRM2
367	INDNDRM3
368	SUPRGNG
369	TABDN
370	TABLDN
371	TABLUP
372	TABSLAP
373	TABUP
374	TAIKO1
375	TAIKO2
376	TAIKO3
377	TAIKOSD1
378	TAIKOSD2
379	TAIKOSD3
380	TONBAK1
381	TONBAK2
382	TONBAK3
383	TONBAK4
384	TONBAK5
385	TONBAK6
386	TONBAK7
387	CHIM1
388	CHIM2
389	SNAP1
390	SNAP2
391	STICK1
392	STICK2
393	TIM1
394	TIM2
395	TIM3
396	TIM4
397	TMPNS1
398	TMPNS2
399	TMPNS3
400	WNDCHM

ELEC. PERCUSSION

No	Name
196	BASS
197	BOLLY
198	CLAP
199	DOWN
200	E_MRCA1
201	E_MRCA2
202	E_MTRI
203	E_TRNGL1
204	E_TRNGL2
205	EBELL1
206	EBELL2
207	ECBSA1
208	ECBSA2
209	ECLAP1
210	ECLAP2
211	ECLAP3
212	ECLAP4
213	ECLAP5
214	ECLAP6
215	ECLAP7
216	ECLAP8
217	ECLAP9
218	ECLAP10
219	ECLAP11
220	ECLAVE
221	ECLICK1
222	ECLICK2
223	ECLICK3
224	ECLICK4
225	ECLICK5
226	ECOWBLL
227	ESHKR_01
228	ESHKR_02
229	ESHKR_03
230	ESHKR_04
231	ESHKR_05
232	ESHKR_06
233	ESHKR_07
234	ESLAP1

235	ESLAP2
236	ESTICK1
237	ESTICK2
238	ETMBRIN1
239	ETMBRIN2
240	MACHINE1
241	MACHINE2
242	MACHINE3
243	MACHINET
244	MONO1
245	PING
246	SCRACH1

Demo Song list

No	Song	Type
01	SONG01	8BEAT
02	SONG02	16BEAT
03	SONG03	DISCO
04	SONG04	WALTZ
05	SONG05	SLOW ROCK
06	SONG06	ROCK BLUES
07	SONG07	COUNTRY ROCK
08	SONG08	HARD ROCK
09	SONG09	FUSION
10	SONG10	JAZZ BLUES
11	SONG11	FUNK
12	SONG12	COUNTRY
13	SONG13	COUNTRY
14	SONG14	COUNTRY
15	SONG15	BLUES
16	SONG16	JAZZ
17	SONG17	JAZZ
18	SONG18	JAZZ
19	SONG19	SMOOTH JAZZ
20	SONG20	BOSSA

WEEE-Declaration / Disposal



Your product is designed and manufactured with materials and components of high quality, which are recyclable and can be reused. The symbol means that your product should be disposed of separately from household waste when it reaches its end of life. Please dispose of this equipment at your local collection point or recycling center. Please help to protect the environment in which we all live.

All specifications and appearances are subject to change without notice. All information was correct at time of printing. Musikhaus Kirstein GmbH does not guarantee for the accuracy or completeness of any description, photograph or statement contained in this manual. Printed colors and specifications may vary slightly from product. Products from Musikhaus Kirstein GmbH are only sold through authorized dealer. Distributors and dealers are not agents of Musikhaus Kirstein GmbH and have no authority to bind Musikhaus Kirstein GmbH legally in any way. This manual is protected by copyright. Any copying or reprint, even in excerpts, is only allowed with written consent of Musikhaus Kirstein GmbH. The same applies to reproduction or copying of images, even in altered form.



Musikhaus Kirstein GmbH

Bernbeurener Strasse 11

86956 Schongau

Telefon: 08861-909494-0

Telefax: 08861-909494-19

www.kirstein.de

