

CLASSIC CANTABILE

Digitalpiano DP-A 610



User manual

INFORMATION FOR YOUR SAFETY!

THE FCC REGULATION WARNING (for USA)

This equipment has been tested and found to comply with the limits for a Class B digital device, pursuant to Part 15 of the FCC Rules.

These limits are designed to provide reasonable protection against harmful interference in a residential installation. This equipment generates, uses, and can radiate radio frequency energy and, if not installed and used in accordance with the instructions, may cause harmful interference to radio communications. However, there is no guarantee that interference will not occur in a particular installation. If this equipment does cause harmful interference to radio or television reception, which can be determined by turning the equipment off and on, the user is encouraged to try to correct the interference by one or more of the following measures:

- Reorient or relocate the receiving antenna.
- Increase the separation between the equipment and receiver.
- Connect the equipment into an outlet on a circuit different from that to which the receiver is connected.
- Consult the dealer or an experienced radio/TV technician for help.

Unauthorized changes or modification to this system can void the user's authority to operate this equipment.

CAUTION

The normal function of the product may be disturbed by Strong Electro Magnetic Interference. If so, simply reset the product to resume normal operation by following the owner's manual. In case the function could not resume, please use the product in other location.

PRECAUTIONS

PLEASE READ CAREFULLY BEFORE PROCEEDING

Please keep this manual in a safe place for future reference.

Power Supply

Please connect the designated DC adaptor to an AC outlet of the correct voltage.

Do not connect it to an AC outlet of voltage other than that for which your instrument is intended.

Unplug the DC power adaptor when not using the instrument, or during electrical storms.

Connections

Before connecting the instrument to other devices, turn off the power to all units. This will help prevent malfunction and / or damage to other devices.

Location

Do not expose the instrument to the following conditions to avoid deformation, discoloration, or more serious damage:

- Direct sunlight
- Extreme temperature or humidity
- Excessive dusty or dirty location
- Strong vibrations or shocks
- Close to magnetic fields

Interference with other electrical devices

Radios and televisions placed nearby may experience reception interference. Operate this unit at a suitable distance from radios and televisions.

Cleaning

Clean only with a soft, dry cloth.

Do not use paint thinners, solvents, cleaning fluids, or chemical-impregnated wiping cloths.

Handling

Do not apply excessive force to the switches or controls.

Do not let paper, metallic, or other objects into the instrument. If this happens, remove the electric plug from the outlet. Then have the instrument inspected by qualified service personnel.

Disconnect all cables before moving the instrument.

Contents

Setup		
Component Guide.....	4	
Setup Guide.....	4	
Panel & Display Description		
Front Panel.....	7	
LCD Display.....	8	
Connections	9	
Power Supply	10	
Adjusting the Master Volume	10	
Adjusting the Brilliance	10	
Playing the Demos	11	
Playing the Voices		
Playing a Voice.....	11	
Playing Two Voices Simultaneously.....	12	
Playing Different Voices with Both Hands.....	12	
Transpose.....	13	
Piano Mode	13	
Twinova	14	
Auto Accompaniment		
Playing Only the Rhythm Tracks.....	15	
Playing All Tracks of a Style.....	15	
Accompaniment Variations.....	16	
Chord Basics.....	16	
Adjusting the Tempo.....	17	
One Touch Setting.....	18	
Metronome.....	18	
Metronome Beat.....	18	
Mixer	19	
DSP Effect	20	
Harmony	21	
Function Menu		
Tune.....	23	
Octave.....	23	
Touch Response.....	23	
Chord Type.....	23	
Lower Split Point.....	23	
Twinova Split Point / Octave.....	23	
Harmony Type.....	24	
EQ.....	24	
String Resonance.....	24	
Soft Pedal.....	24	
Freeze.....	25	
Metronome Beat.....	25	
Fade Time.....	25	
MIDI Out Channel.....	25	
Song Looping.....	25	
Auto Power Off.....	25	
System Time.....	26	
Bluetooth Auto Link.....	26	
Factory Reset.....	26	
Performance Memory		
Registering the Panel Settings.....	27	
Recalling the Memory Settings.....	27	
Selecting a Memory Bank.....	27	
Freezing Specific Settings.....	27	
Song Recording	28	
MIDI Recording		
Prepare Recording.....	28	
Start Recording.....	28	
Stop Recording.....	28	
Play Back Recording.....	28	
Audio Recording	29	
Song		
Play the Songs.....	30	
Control the Song Playback.....	30	
Practice the Songs.....	30	
Bluetooth	31	
Connecting USB Flash Drive		
Playing.....	32	
Saving.....	32	
Loading.....	32	
Formatting.....	32	
MIDI		
What's MIDI?.....	33	
Troubleshooting	33	
Specifications	34	
Appendices		
Voice List.....	36	
Style List.....	47	
Song List.....	49	
Demo List.....	49	
Chord List.....	50	
MIDI Implementation Chart.....	51	

Setup

This section contains information about setting up your instrument and preparing to play. Please read through this section carefully before turning the power on.

Component Guide

Check that all the parts listed below are included before proceeding to the Setup Guide.

Setup Guide

To assemble the stand, you will need a Phillip's screwdriver (not supplied).

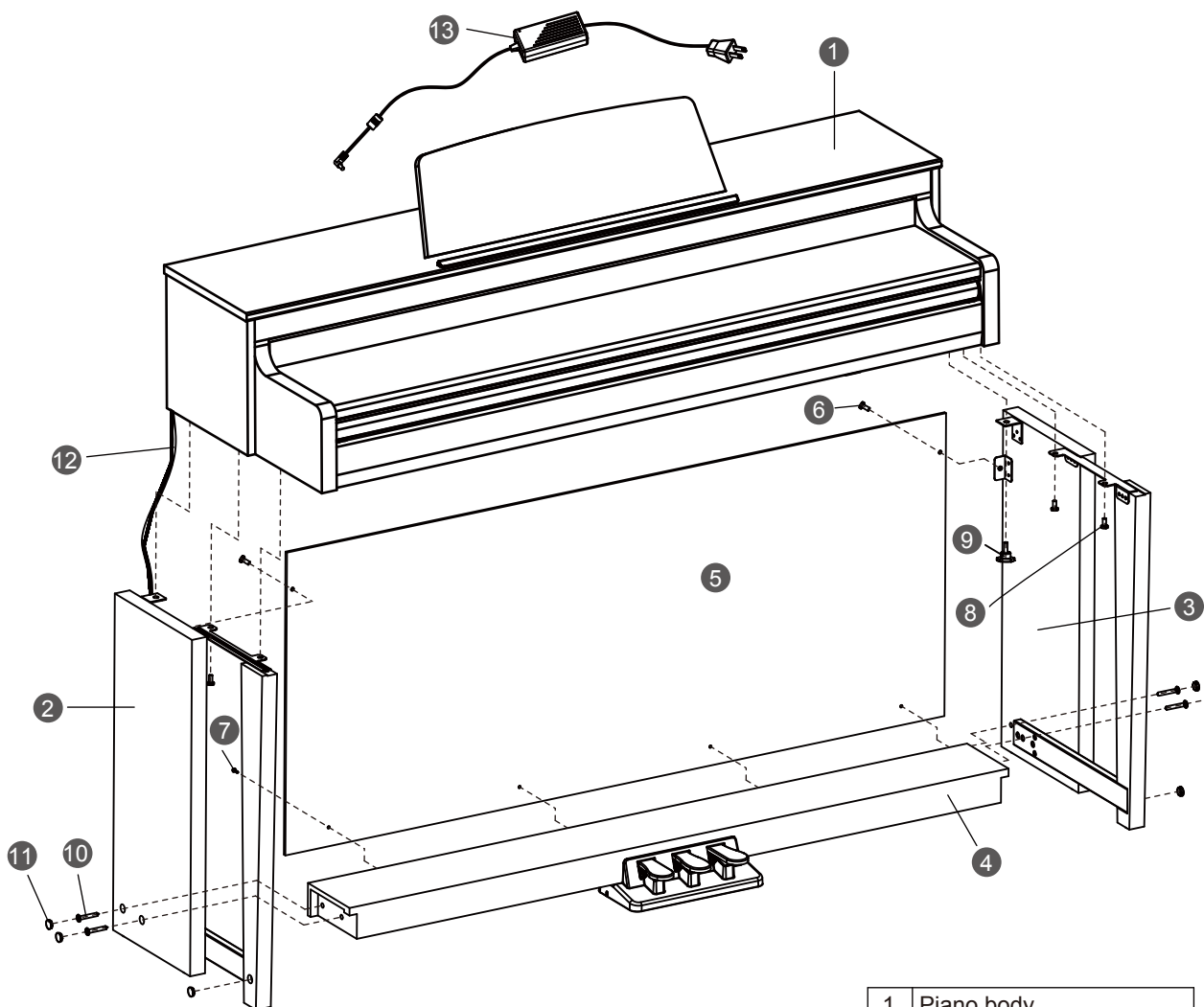

1	Piano body
2	Left stand component
3	Right stand component
4	Pedal assembly
5	Back board
6	Screws 6x12 BM (2PCS)
7	Screws 4x15 PA (4PCS)
8	Screws 6x18 BM (4PCS)
9	Hand screws (2PCS)
10	Screws 6x50 PA (4PCS)
11	Screw caps (6PCS)
12	Pedal cable
13	AC power adaptor



Setup

- A. Put the “pedal box” between the “left and right stand components.” Use “Screws 6x50PA (4pcs)” to stabilize the “left and right stand components” onto to the pedal assembly, then cover with “Screw caps (6pcs)”, as shown in the picture.

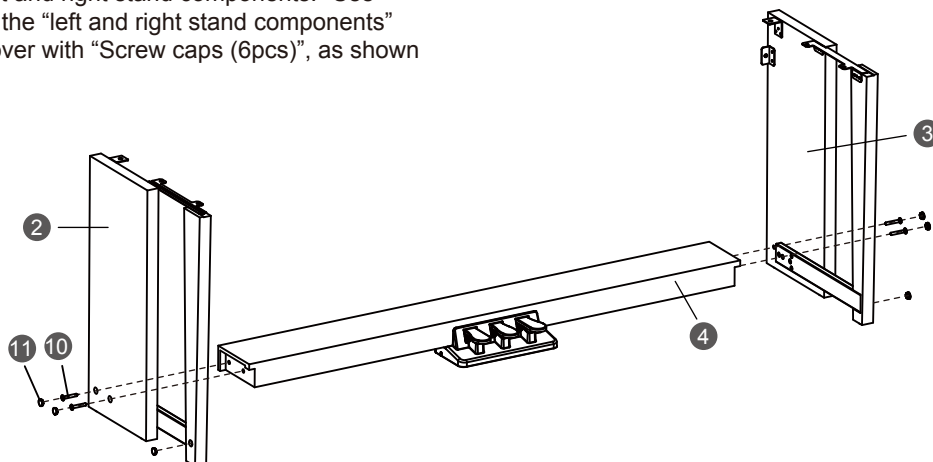

- B. Use “Screws 6x12BM(2PCS)” and “Screws 4x15PA(4PCS)” to affix the back board to the stands, as shown in the picture.

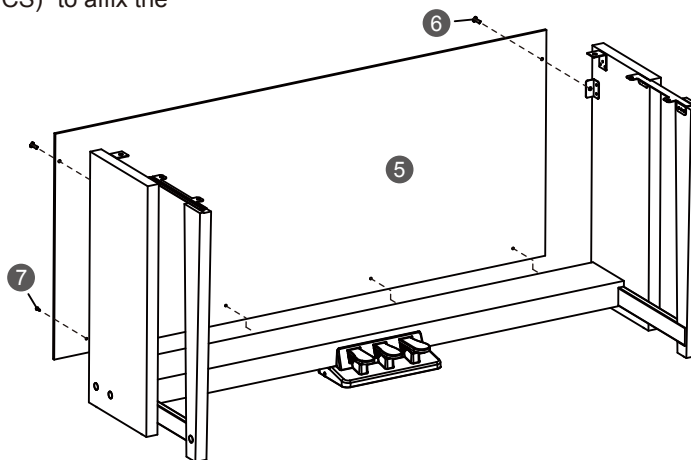

- C. Put the “piano body” on the top of the assembly finished in part B, then affix it with “Screws 6x18 BM (4PCS)” and “Hand Screws (2PCS)”, as shown in the picture.

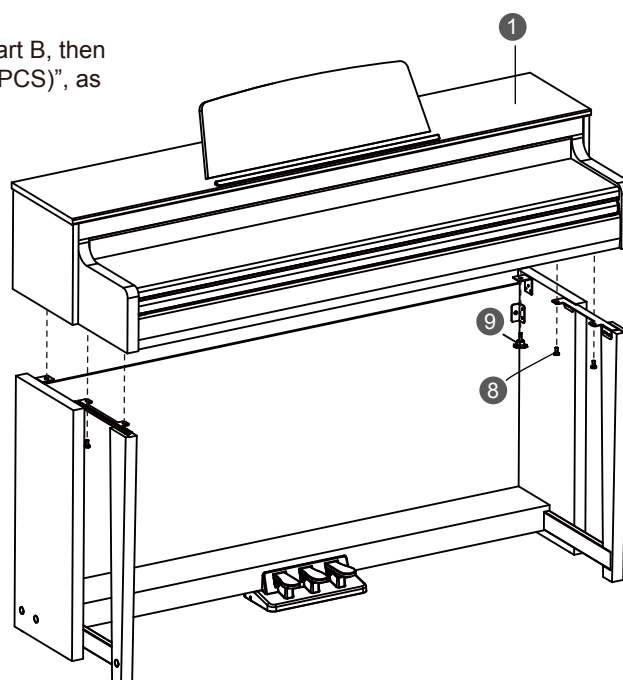

Setup

D. Connect the “pedal cable” to the pedal jack at the bottom rear of the Piano.
Then connect the power cable to the power jack, and plug the other end into an AC outlet. At this point the Piano is fully assembled and you can turn on the power.

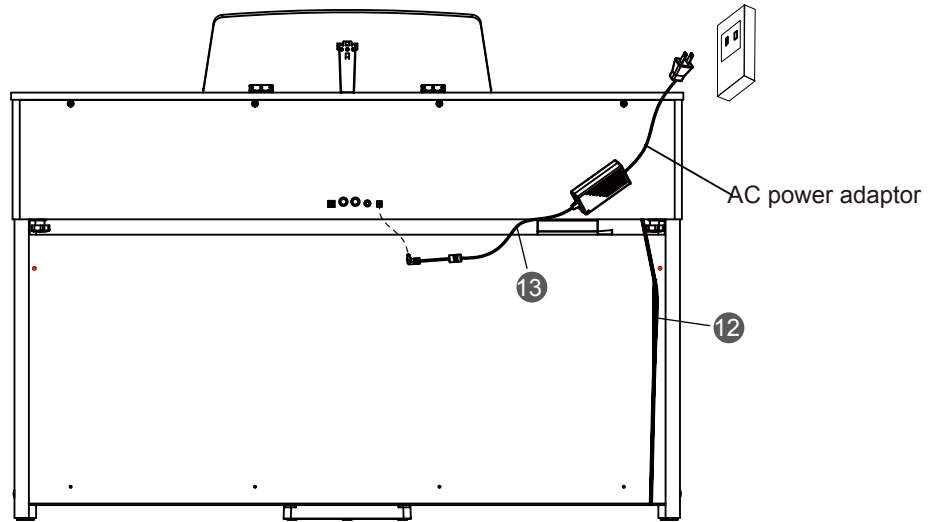

Panel & Display Description

Front Panel

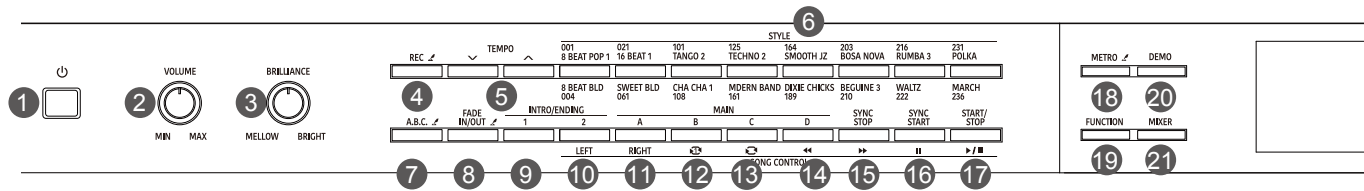

1. [POWER] Switch

Turn the power on or off.

2. [VOLUME] Knob

Adjust the master volume.

3. [BRILLIANCE] Knob

Adjust the brilliance.

4. [REC] Button

USB flash drive inserted: press the button to enter Audio Recording.

USB flash drive not inserted: press the button to enter MIDI Recording.

Press and hold the button to enter the recording setting menu.

5. [TEMPO +/-] Buttons

Press to edit the tempo value.

6. STYLE Select Buttons

Directly set a preset style. Press a button once to select the first preset style, press it again to select the second preset style.

7. [A.B.C.] Button

Press it to turn the A.B.C. function on or off.

Press and hold it to enter the Chord setting menu.

8. [FADE IN/OUT] Button

Press it to turn the Fade In or Fade Out on or off.

Press and hold it to enter the Fade Time setting menu.

9. [INTRO/ENDING 1] Button

Play the Intro or Ending pattern 1.

10. [INTRO/ENDING 2] Button

In style mode: play the Intro or Ending pattern 2.

In song mode: mute/activate the left hand part.

11. [MAIN A] Button

In style mode: play the Main pattern A.

In song mode: mute/activate the right hand part.

12. [MAIN B] Button

In style mode: play the Main pattern B.

In song mode: play the current song in a loop.

13. [MAIN C] Button

In style mode: play the Main pattern C.

In song mode: play all songs in a loop.

14. [MAIN D] Button

In style mode: play the Main pattern D.

In song mode: rewind the song playback.

In Bluetooth mode: play the previous Bluetooth song.

15. [SYNC STOP] Button

In style mode: turn the Sync Stop function on or off.

In song mode: fast forward the song playback.

In Bluetooth mode: play the next Bluetooth song.

16. [SYNC START] Button

In style mode: turn the Sync Start function on or off.

In song mode: pause the song playback.

In Bluetooth mode: pause playing the Bluetooth song.

17. [START/STOP] Button

Start or stop playing a song or a style.

Start or stop playing a Bluetooth song.

18. [METRO] Button

Press it to turn the Metronome on or off.

Press and hold it to enter the Metronome setting menu.

19. [FUNCTION] Button

Press it to enter the Function menu.

20. [DEMO] Button

Press it to enter Demo mode.

21. [MIXER] Button

Press it to enter the Mixer menu.

22. [STYLE] Button

Press it to enter Style mode.

23. [USB] Button

Press it to enter the USB Play menu.

Press and hold it to enter the USB menu.

24. [VOICE] Button

Press it to enter Voice mode.

25. [SONG/🎵] Button

When Bluetooth is disabled, press it to enter Song mode.

When Bluetooth is connected, press it once to enter Bluetooth mode, press it again to switch to Song mode.

Panel & Display Description

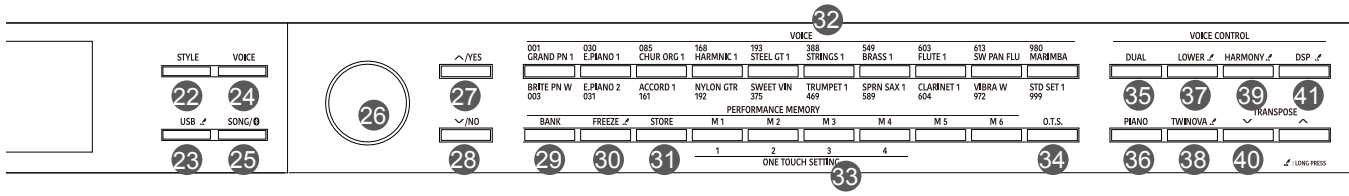

26. Data Dial
Adjust the parameters.

27. [+ / YES] Button
Increase the value.
Press [+ / YES] and [- / NO] together to restore default settings.

28. [- / NO] Button
Decrease the value.
Press [+ / YES] and [- / NO] together to restore default settings.

29. [BANK] Button
Select a memory bank.

30. [FREEZE] Button
Press it to turn the Freeze function on or off.
Press and hold it to enter the Freeze setting menu.

31. [STORE] Button
Save current panel settings to one of the memories.
Press [STORE] and [M1] together to save the settings to M1.

32. VOICE Select Buttons
Directly select a preset voice.
Press a button once to select the first preset voice, press it again to select the second preset voice.

33. [M1]-[M6] Buttons
In memory mode: recall panel settings from one of the memories.
In O.T.S. mode: recall voice settings that match the current style.

34. [O.T.S.] Button
Press it to turn the One Touch Setting function on or off.

35. [DUAL] Button
Press it to turn the Dual function on or off.

36. [PIANO] Button
Press it to enter Piano Mode.

37. [LOWER] Button
Press it to turn the Lower function on or off.
Press and hold it to enter the Split Point setting menu.

38. [TWINOVA] Button
Press it to turn the Twinova function on or off.
Press and hold it to enter the Twinova Split setting menu.

39. [HARMONY] Button
Press it to turn the Harmony function on or off.
Press and hold it to enter the Harmony setting menu.

40. [TRANSPOSE +/-] Buttons
Adjust the transpose value.

41. [DSP] Button
Press it to turn the DSP effect on or off.
Press and hold it to enter the DSP setting menu.

LCD Display

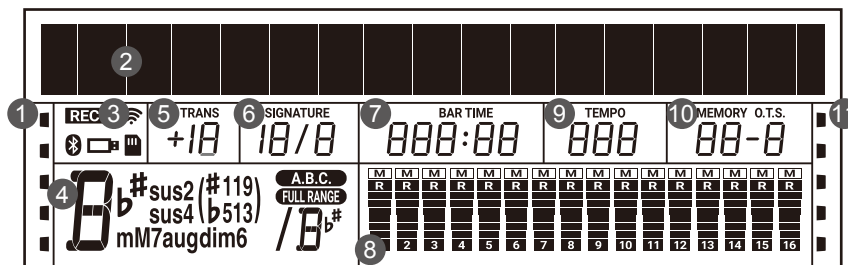

- 1. Function Indicators
- 2. 192x16 Dot Matrix LCD
- 3. Function Indicators
- 4. Chord
- 5. Transpose
- 6. Beat
- 7. Measure/Beat/Time
- 8. During playback, shows the MIDI Channel Volume
When playback stops, shows the track Volume
- 9. Tempo
- 10. Memory/O.T.S.
- 11. Function Indicators

Connections

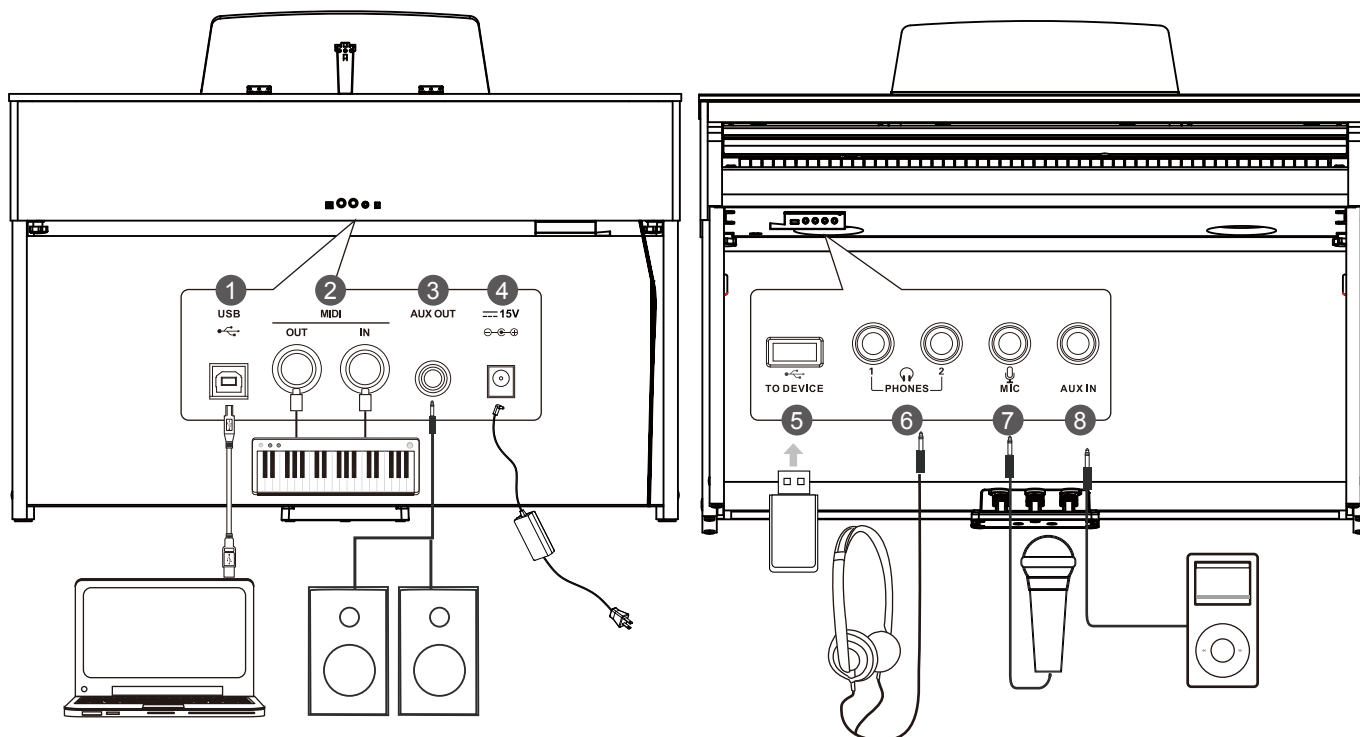

1. USB Jack

Use a standard USB cable to connect the USB jack of the instrument to the USB port of a computer. With USB, you can save a keyboard performance to the computer or use the instrument to play back music played on the computer.

Note:

Do not set the USB MIDI device to be both input and output simultaneously when configuring the software on your computer. Otherwise, the sound will be overlapped when playing the keyboard.

2. MIDI OUT, MIDI IN Jacks

Use a standard MIDI cable to connect the MIDI OUT jack of the instrument to the MIDI IN jack of an external device. The instrument will transmit MIDI messages to the external device and work as a MIDI controller.

Use a standard MIDI cable to connect the MIDI IN jack of the instrument to the MIDI OUT jack of an external device. The instrument will receive MIDI messages from the external device and work as a sound source.

3. AUX OUT Jack

The AUX OUT jack delivers the output of the instrument to external audio equipment such as a keyboard amplifier, stereo sound system, mixing console, or recording interface. Use an audio cable to connect the AUX OUT jack of the instrument to the INPUT jack of the external audio equipment.

Notes:

1. Turn off the power to all devices before connecting or disconnecting external equipment.
2. To avoid damaging the speakers, set the master volume level to minimum before turning on the power.

4. DC IN Jack

Connect the specified power adaptor.

5. USB Port

Connect a USB flash drive to the instrument to save the data you've created to the USB flash drive. You can also load files from a USB flash drive to the instrument, or use the instrument to play back files saved on USB flash drive.

Note:

To avoid errors or damaging the USB flash drive, do not remove it when reading or writing is in progress

6. PHONES Jack

Plug a pair of standard stereo headphones into the PHONES jack for private practice or late-night playing. When headphones are connected, the internal speakers will be muted, and the sound can only be heard from the headphones.

Note:

To avoid the risk of hearing loss, do not use headphones at high volume level for a long period of time.

7. MIC Jack

Before connecting or disconnecting a microphone, set the master volume level to minimum. Plug the microphone into the MIC jack, then adjust the master volume to an appropriate level.

Note:

Please unplug the microphone when it is not in use.

8. AUX IN Jack

The AUX IN jack receives audio signals from an external audio source such as an MP3 or a CD player. Use an audio cable to connect the AUX IN jack of the instrument to the OUTPUT jack of an MP3/CD player. The instrument's speakers will play the music transmitted from the external player, and you can play along.

Power Supply

1. Before connecting the power supply, please set the [POWER] switch to "OFF" and set the master volume level to minimum.
2. Connect the power adaptor to the DC IN jack on the rear panel.
3. Plug the power adaptor into an appropriate AC outlet.
4. Press the [POWER] switch. The LCD will light up and display the welcome interface, indicating the instrument is powered on.
5. When you are ready to turn the instrument off, press and hold the [POWER] switch for a second. The LCD light will turn off.



Notes:

1. In order to save energy, the instrument will automatically shut down after 30 minutes when not in use. (see **Auto Power Off**).
2. For your safety, please unplug the instrument when it is not in use or during a thunderstorm.

Adjusting the Master Volume

Rotate the [VOLUME] knob clockwise to increase the master volume or counter-clockwise to decrease it. Adjust to set the desired volume level.

Note:

If the speakers do not produce sound, check if the master volume is set too low or if headphones are plugged into the PHONES jack.

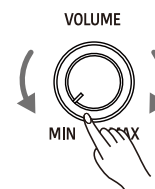

Adjusting the Brilliance

Use the [BRILLIANCE] knob to adjust the overall brilliance level. The brilliance is set to medium by default. Rotate the knob clockwise to brighten the sound, or counter-clockwise to mellow the sound.

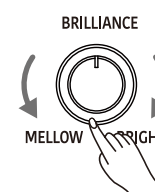

Playing the Demos

The instrument features several professional demos. Please refer to the **Demo List** for details.

1. Start playing the demo.
Press the [DEMO] button to enter Demo mode and start playing the demos in a continuous loop. The LCD shows the current demo number and name.
2. Select a demo.
Use the data dial or [+/Yes]/[-/No] buttons to select a desired demo.
3. Stop playing the demo.
Press the [START/STOP] button to stop playing and exit Demo mode.

Note:

During demo playback, playing the keyboard will not produce sound.

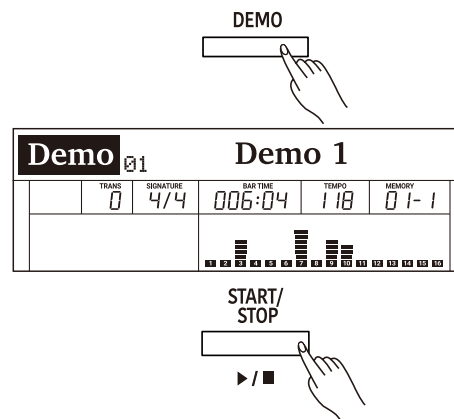

Playing the Voices

The instrument features a variety of realistic voices. Please refer to the **Voice List** for details.

Playing a Voice

1. Enter the voice mode.
Press the [VOICE] button or one of the VOICE select buttons to enter Voice mode. The "R1" indicator appears and the LCD shows the current voice number and name.
2. Select a voice to play.
Use the data dial or [+/Yes]/[-/No] buttons to select a desired voice. You can also use the VOICE select buttons to select a preset voice.
3. Play the selected voice.
Play the keyboard to use the selected voice for performance.

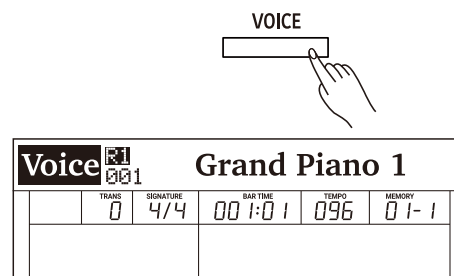

Playing the Voices

Playing Two Voices Simultaneously

The Dual function allows two different voices to be layered together, creating a more full and rich sound. Turn this function on and select a voice for the dual voice "R2".

1. Turn on the dual function.
Press the [DUAL] button to turn on the Dual function. The "R2" indicator appears and the LCD shows the current dual voice number and name.
2. Select a dual voice.
Use the data dial or [+Yes]/[-No] buttons to select a dual voice. You can also use the VOICE select buttons to select a preset voice.
3. Play the voices.
Play the keyboard and you will hear two different voices playing together, just like two different instruments being played at the same time.
4. Turn off the dual function.
Press the [DUAL] button again to turn off the Dual function.

DUAL

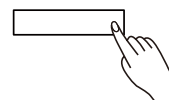

Voice	R1	R2	Modern EP 2		
	034				
	TRANS	SIGNATURE	BAR TIME	TEMPO	MEMORY
	0	4/4	00 1:0 1	096	0 1- 1

Playing Different Voices with Both Hands

The Lower function splits the keyboard into two areas so as to create different voices for each of your hands. The left hand voice is the lower voice "L".

1. Turn on the lower function.
Press the [LOWER] button to turn on the Lower function. The "L" indicator appears. The LCD shows the current lower voice number and name.
2. Select a lower voice.
Use the data dial or [+Yes]/[-No] buttons to select a lower voice. You can also use the VOICE select buttons to select a preset voice.
3. Play the voices.
Play the keyboard with both hands and you will hear two different voices from the left and right hand areas.
4. Set the lower split.
Press and hold the [LOWER] buttons to enter the lower split setting menu, then use the [+Yes]/[-No] buttons or press a key on the keyboard to assign the lower split.
Press [+YES] and [-NO] at the same time to restore the default lower split.
5. Turn off the lower function.
Press the [LOWER] button again to turn off the lower function.

LOWER

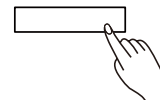

Voice	R1	R2	Electric Grand 3		
	026				
	TRANS	SIGNATURE	BAR TIME	TEMPO	MEMORY
	0	4/4	00 1:0 1	096	0 1- 1

Switch between Voice R1 / R2 / L

The voice "R1" is turned on by default, and cannot be turned off. The dual voice "R2" and lower voice "L" can be turned on/off as desired. In voice mode, when the R1, R2, and L voices are all in use, you can press the [VOICE] button repeatedly to switch between different voice layers.

Playing the Voices

Lower Split

The key that splits the keyboard into the left and right hand areas is called "Lower Split". The default lower split is F#3 (34), however, you can assign it to any other key. Please refer to the **Function Menu** for details.

Notes:

1. When the Lower and Dual functions are in use, only the right hand area will play the dual voices.
2. You can adjust the volume for voice R1/ R2/ L separately in the Mixer. Please refer to **Mixer** for details.

Transpose

The transpose function allows the overall pitch of the instrument to be transposed up or down by a maximum of one octave in semitone steps.

1. Enter the transpose setting interface.
Press the [TRANSCOPE+] / [TRANSCOPE-] buttons to edit the transpose setting. The LCD shows the current transpose value.
2. Adjust the transpose value.
Use the data dial, [+ / Yes] / [- / No] buttons or [TRANSCOPE+] / [TRANSCOPE-] to adjust the transpose value.
3. Reset the transpose to default.
Press the [TRANSCOPE+] and [TRANSCOPE-] buttons at the same time to reset the value to default.

Notes:

1. For example, if you set the transpose value to -05 or 007, you will hear "G" pitch when playing the "C" keys.
2. Transpose setting applies to the accompaniment and the entire keyboard voice.

Func		LOWER SPLIT			F#3
TRANS	SIGNATURE	BAR TIME	TEMPO	MEMORY	
0	4/4	00 1:0 1	096	0 1- 1	

Default Lower Split

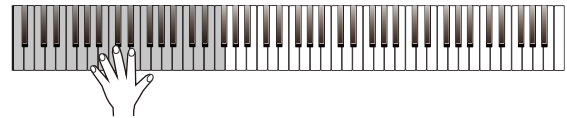

TRANSCOPE

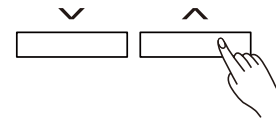

Voice		Grand Piano 1		
TRANS	SIGNATURE	BAR TIME	TEMPO	MEMORY
+ 1	4/4	00 1:0 1	096	0 1- 1

Piano Mode

Piano Mode is specially designed for piano players. It recreates the voice and touch of a real acoustic piano. By pressing the [PIANO] button, the instrument replicates a concert grand voice. All parameters become optimized for concert piano performance.

Press the [PIANO] button to enter or exit Piano Mode.

Note:

In Piano Mode, the Dual and Lower functions will not be available.

PIANO



Concert Grand					
TRANS	SIGNATURE	BAR TIME	TEMPO	MEMORY	
0	4/4	00 1:0 1	096	0 1- 1	

Twinova

The Twinova function splits the keyboard into two areas with the same pitch and voice, for the convenience of playing together with a friend or instructor.

1. Turn on the Twinova function.
Press the [TWINOVA] button to turn on the function. The default split point is E3.

2. Set the Split Point for Twinova.
Press and hold [TWINOVA] to enter the setting menu. Use the data dial to select "TWINOVA SPLIT", then use the [+ / YES] / [- / NO] buttons to assign the split point. You can also tap a key on the keyboard to assign the split point to that key.

3. Set the Octave for Twinova.
Press and hold [TWINOVA] to enter the setting menu. Use the data dial to select "TWINOVA OCTAVE", then use the [+ / Yes] / [- / No] buttons to adjust the octave range from -2 to +2.

TWINOVA 

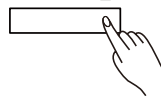

Twinova					
TRANS	SIGNATURE	BAR TIME	TEMPO	MEMORY	
0	4/4	00 1:0 1	096	0 1-1	

Func TWINOVA SPLIT E3					
TRANS	SIGNATURE	BAR TIME	TEMPO	MEMORY	
0	4/4	00 1:0 1	078	0 1-1	

Func TWINOVA OCTAVE 0					
TRANS	SIGNATURE	BAR TIME	TEMPO	MEMORY	
0	4/4	00 1:0 1	078	0 1-1	

Pedal Function in Twinova

Left Pedal: notes played on the left hand area will have longer sustain.

Middle Pedal: notes played on both areas will have longer sustain.

Right Pedal: notes played on the right hand area will have longer sustain.

Note:

In Twinova mode, both the Dual and Lower functions will not be available.

Auto Accompaniment

The auto accompaniment function puts a full backing band at your fingertips. All you have to do is to play chords with your left hand, and the accompaniment will automatically play along, following the chords you play. With auto accompaniment, even a solo performer can enjoy the experience of playing with a full band or orchestra.

The instrument features a variety of styles. Please refer to the **Style List** for details.

Playing Only the Rhythm Tracks

1. Enter the style mode.
Press the [STYLE] button to enter Style mode. The LCD shows the current style number and name.
2. Select a style to play.
Use the data dial or [+/Yes]/[-/No] buttons to select a desired style. You can also use the STYLE select buttons to select a preset style.
3. Start playing auto accompaniment of the rhythm tracks.
Press the [START/STOP] button to start playing the rhythm tracks. Alternatively, press the [SYNC START] button, then play the keyboard to start rhythm playback.

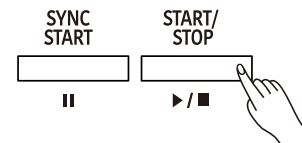
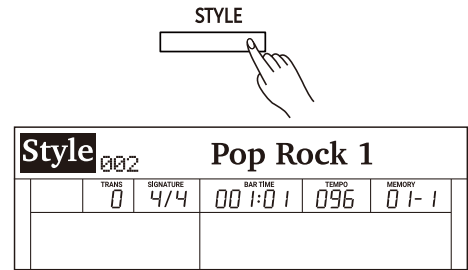

Playing All Tracks of a Style

During rhythm playback, if you turn on the chord mode and then play a chord on the keyboard, it will start the chord part as well.

In chord mode, you can play chords in the following ways: Fingered, Multi-finger, Bass Invert and Full Range. Except for Full Range, the other three will divide the keyboard into two areas (same as in the Lower function).

Chord Type	Description
Fingered	Automatically detects Single Finger and Multi Finger chords.
Multi Finger	Detects only Multi Fingerchords.
Bass Invert	Detects Multi Finger chord inversion of bass track.
Full Range	Detects Multi Finger chords over the entire keyboard range and supports Bass Invert.

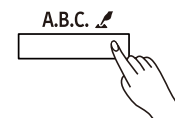

1. Turn on the A.B.C. function.
Press the [A.B.C.] button to turn on the A.B.C. Function. The LED button lights up. Press the button repeatedly to switch between "A.B.C." → "FULL RANGE" → "OFF".

To select a desired way to play chords, press and hold the [A.B.C.] button to enter the setting menu, then use the [+ / YES] / [- / NO] buttons to select a chord type.

2. Start playing auto accompaniment of all tracks.
Press the [SYNC START] button to turn on the Sync Start function. The LED button lights up. When you play a chord in the chord section, it will start the auto accompaniment of all tracks. When you play a different chord, the accompaniment will change along with you.

Alternatively, press the [START/STOP] button to start rhythm playback. Then play a chord in the chord section, and the chord part will start as well.

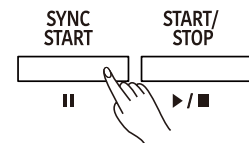
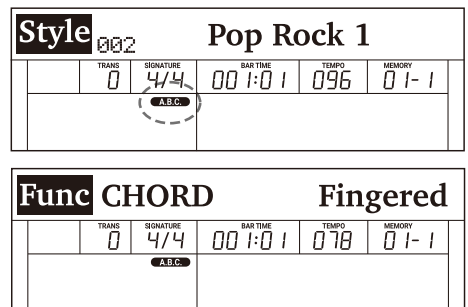

Auto Accompaniment

Accompaniment Variations

Specially created variation patterns can be added into the accompaniment, making your performance more professional and personalized.

INTRO

The Intro is the opening section of a song. When the Intro pattern is finished, it will automatically shift to the selected Main section. The length of the Intro section differs depending on the selected style.

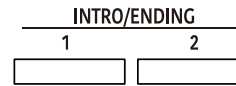

MAIN

The Main is the principal section of a song. It will play and repeat the Main pattern until another section's button is pressed.

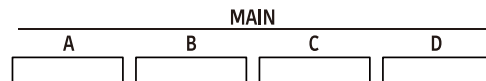

FILL IN

The Fill-in will automatically add a fill to your performance. When the Fill-in pattern is finished, it will shift to the related Main section.

ENDING

The Ending is the ending section of a song. When the Ending pattern is finished, the accompaniment will stop as well.

The length of the Ending section differs depending on the selected style.

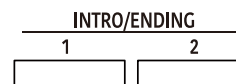

Note:

During style playback, if you press and hold one of the MAIN [A]-[D] buttons, the Fill-in pattern will repeat until the button is released. Playback will then switch to the related Main section.

Chord Basics

A chord, in music, is a harmonic set of three or more notes that are heard simultaneously. The most common type of chord is a triad. A triad is a set of three notes that can be stacked in thirds. When arranged this way, the triad's notes, from lowest pitched to highest, are called: the Root, the Third, and the Fifth.

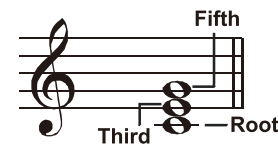

Triad Type

The basic triad types are as follows:

Major Triad	A root with a major third added above and a perfect fifth constitutes a "Major Triad".
Minor Triad	A root with a minor third added above and a perfect fifth constitutes a "Minor Triad".
Augmented Triad	A root with a major third added above and an augmented fifth constitutes an "Augmented Triad".
Diminished Triad	A root with a minor third added above and a diminished fifth constitutes a "Diminished Triad".

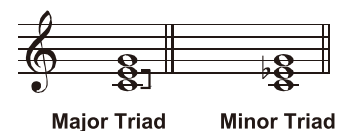

Chord Inversion

When a chord's root is not the lowest note in the triad, it is called an inversion chord. When the root note is the lowest note, it is called a root-position chord. If we put the Third and Fifth in the root position, it forms an "Inversion", so it is called an "Inverted Chord". A major triad and its inversion are illustrated on the right.



Chord Name



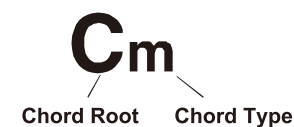

The chord name consists of two parts: Chord root and Chord type.



Auto Accompaniment

Single Finger

Single-finger makes it easy to produce major, seventh, minor and minor seventh chords by pressing a minimum number of keys on the auto accompaniment section.

	★Major Triad Only press the root note on the keyboard.
	★Minor Triad Press the root note and the nearest left black key simultaneously.
	★Seventh chord Press the root note and the nearest left white key simultaneously.
	★Minor seventh chord Press the root note and the nearest left white and black keys simultaneously.

Multi-finger

Multi-finger allows you to play chords in normal fingering. Try playing the 32 types of C chords listed on the right.

0 C	1 C ₆	2 CM ₇	3 CM ₇ (#11)	4 CM(9)	5 CM ₇ (9)
6 C ₆ (9)	7 Caug	8 Cm	9 Cm ₆	10 Cm ₇	11 Cm ₇ (b5)
12 Cm(9)	13 Cm ₇ (9)	14 Cm ₇ (11)	15 CmM ₇	16 CmM ₇ (9)	17 Cdim
18 Cdim ₇	19 C ₇	20 C ₇ sus4	21 C ₇ (b5)	22 C ₇ (9)	23 C ₇ (#11)
24 C ₇ (13)	25 C ₇ (b9)	26 C ₇ (b13)	27 C ₇ (#9)	28 CM ₇ aug	29 C ₇ aug
30 Csus ₄	31 C1+2+5	Notes enclosed in parentheses are optional; the chords could be recognized without them.			

Full Range

In Full Range mode, it detects chords played in normal fingering (Multi-finger) over the entire keyboard range.

Adjusting the Tempo

Each style is preset with a default or standard tempo, but you can change it as needed.

- Adjust the tempo.
Press the [TEMPO+]/[TEMPO-] buttons to edit the tempo setting. The tempo value will flash on the LCD. Use the data dial or [+YES]/[-NO] buttons to change the value.
- Reset the tempo to default.
When the tempo value is flashing, press the [+YES] and [-NO] buttons at the same time to reset the tempo to default.

Note:

When style stops, changing the style will automatically reset the tempo. However, changing the style during style playback will not result in tempo change.

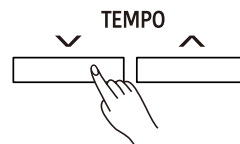

Style 002	Pop Rock 1			
TRANS	SIGNATURE	BARTIME	TEMPO	MEMORY
0	4/4	00:1:01	086	01-1
A.B.C.				

Auto Accompaniment

One Touch Setting

When One Touch Setting is switched on, you can instantly recall all auto accompaniment related settings including voice selection and digital effects, all with the single touch of a button.

1. Turn on the One Touch Setting function.
Press the [O.T.S.] button to turn on the function. The "O.T.S" indicator lights up and the A.B.C. function will be turned on.

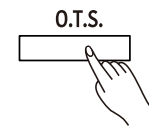

Style 002		Pop Rock 1			
TRANS	SIGNATURE	BAR TIME	TEMPO	O.T.S.	
0	4/4	00 1:01	096	1	
A.B.C.					

2. Recall the settings in O.T.S. mode.
Press one of the [M1] - [M4] buttons. Various panel settings (including voice and effects) that match the current style will be recalled instantly. Each style has 4 preset settings.

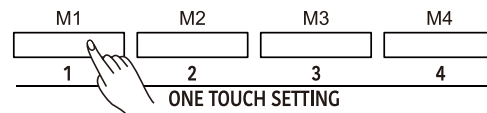

Parameters in One Touch Setting:

Part on/off, voice number, voice volume, voice octave setting, voice reverb level, voice chorus level, voice pan.

Note:

In O.T.S. mode, the Performance Memory is not available.

Metronome

The metronome provides a steady beat to help you practice at a preset tempo.

1. Turn on the metronome.
Press the [METRO] button to turn on the metronome. Beats on the LCD will flash in sync with the metronome sound.
2. Turn off the metronome.
Press the [METRO] button again to turn off the metronome.

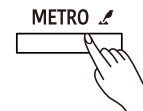

Notes:

1. If you turn on the metronome during style playback, the metronome sound will start from the next beat and its time signature will match the current style.
2. In MIDI Recording, if you can turn on the metronome, the metronome sound will not be recorded.
3. In Audio Recording, if you turn on the metronome, the metronome sound will be recorded.

Metronome Beat

Press and hold the [METRO] button to enter the setting menu, then use the [+ / YES] / [- / NO] buttons to change the metronome beat.

Func METRO		4/4			
TRANS	SIGNATURE	BAR TIME	TEMPO	MEMORY	
0	4/4	00 1:01	096	01-1	

Mixer

The Mixer function allows you to separately adjust the volume of each track, so as to keep an appropriate volume balance.

1. Enter the Mixer menu.

Press the [MIXER] button to enter the Mixer menu. The LCD shows the current parameter.

2. Select a parameter.

Use the data dial to select a parameter.

3. Adjust the volume level.

Use the [+ / YES] / [- / NO] buttons to adjust the volume of the current item. Press [+ / YES] and [- / NO] at the same time to switch between the default volume and muting the volume.

MIXER



Mixer		MUSIC VOL:			20
TRANS	0	SIGNATURE	4/4	BAR TIME	00 1:0 1
		TEMPO	096	MEMORY	01-1

Detailed parameters and their volume ranges:

Parameter	LCD Display	Volume Range
Music volume	MUSIC VOL: xxx	0 - 32
Voice R1 volume	R1 VOL: xxx	0 - 32
Voice R2 volume	R2 VOL: xxx	0 - 32
Voice L volume	L VOL: xxx	0 - 32
Metronome volume	METRO VOL: xxx	0 - 32
Mic volume	MIC VOL: xxx	0 - 32
Rhythm sub. volume	RHYTHM_S VOL: xxx	0 - 32
Rhythm master volume	RHYTHM_M VOL: xxx	0 - 32
Bass volume	BASS VOL: xxx	0 - 32
Chord 1 volume	CHORD1 VOL: xxx	0 - 32
Chord 2 volume	CHORD2 VOL: xxx	0 - 32
Chord 3 volume	CHORD3 VOL: xxx	0 - 32
Phrase 1 volume	PHRASE1 VOL: xxx	0 - 32
Phrase 2 volume	PHRASE2 VOL: xxx	0 - 32

DSP Effect

The DSP effects will add ambiance and depth to your performance in a variety of ways. They can be set to simulate sound from a real environment, making your tone more crystal and strong, or even give you distortion for a rougher edge. Experiment with the various effects to find the ones that work best for you.

Turn the DSP Effect on or off.

The DSP effect is turned on by default. You can press the [DSP] button to turn the function on or off.

Set the DSP Effect.

1. Press and hold the [DSP] button to enter the DSP settings menu.
2. Use the data dial to select a parameter.
3. Use the [+ / YES] / [- / NO] buttons to change the settings of the selected parameter.

DSP 



DSP R1 DSP Type					Hall
TRANS	SIGNATURE	BAR TIME	TEMPO	MEMORY	
0	4/4	00:1:01	096	01-1	

DSP effect parameters and their ranges:

Parameter	Display	Range
Voice R1 DSP Effect Type	R1 DSP TYPE xxx	Hall, Room, Crs.Dely, Tp.Delay, Tp.Echo, Chorus, Flanger, Phaser, Overdriv, Amp, Metl.Dst, Hard.Dst, Tremolo, Auto.Wah, Tp.Wah, None(Off)
Voice R1 DSP Effect Level	R1 DSP LEVEL xxx	0-32
Voice R1 Global Reverb Level Send	R1 G.REV SEND xxx	0-32
Voice R1 Global Chorus Level Send	R1 G.CHR SEND xxx	0-32
Voice R2 DSP Effect Type	R2 DSP TYPE xxx	Hall, Room, Crs.Dely, Tp.Delay, Tp.Echo, Chorus, Flanger, Phaser, Overdriv, Amp, Metl.Dst, Hard.Dst, Tremolo, Auto.Wah, Tp.Wah, None(Off)
Voice R2 DSP Effect Level	R2 DSP LEVEL xxx	0-32
Voice R2 Global Reverb Level Send	R2 G.REV SEND xxx	0-32
Voice R2 Global Chorus Level Send	R2 G.CHR SEND xxx	0-32
Voice L DSP Effect Type	L DSP TYPE xxx	Hall, Room, Crs.Dely, Tp.Delay, Tp.Echo, Chorus, Flanger, Phaser, Overdriv, Amp, Metl.Dst, Hard.Dst, Tremolo, Auto.Wah, Tp.Wah, None(Off)
Voice L DSP Effect Level	L DSP LEVEL xxx	0-32
Voice L Global Reverb Level Send	L G.REV SEND xxx	0-32
Voice L Global Chorus Level Send	L G.CHR SEND xxx	0-32
Microphone DSP Effect Type	MIC DSP TYPE xxx	Echo1, Echo2, Echo3, Phaser1, Phaser2, Enhanc, Wah, Overdv1, Overdv2, Lo-Fi, Comp, Gate, None(Off)
Microphone DSP Effect Level	MIC DSP LEVEL xxx	0-32
Microphone Global Reverb Level Send	MIC G.REV SEND xxx	0-32
Microphone Global Chorus Level Send	MIC G.CHR SEND xxx	0-32
Global Reverb Type	G.REV TYPE xxx	Hall1, Hall2, Hall3, Hall4, Pno.Hall, Room1, Room2, Room3, Church, Garage, Std.Hall
Global Reverb Level	G.REV LEVEL xxx	0-32
Global Chorus Type	G.CHR TYPE xxx	Chorus1, Chorus2, Chorus3, Chorus4, GM.Chr1, GM.Chr2, Celeste1, Celeste2, Sympho1, Sympho2, Doubler, Std.Chr
Global Chorus Level	G.CHR LEVEL xxx	0-32

Note:

There may be a slight pause in the sound if you switch the DSP effect on/off while style or song is playing.

Harmony

The harmony function will automatically add harmony effect to the notes you play in the right hand area, enriching your performance with more harmonic expression.

Playing with Harmony

1. Press the [HARMONY] button to turn on the function. The button LED lights up.
2. Turn on the A.B.C. function, then play a chord in the left hand area. When you play in the right hand area, it will add harmony effect to the notes you play.
3. Press the [HARMONY] button again to turn off the function. The LED light turns off.



Setting the Harmony Type

1. Press and hold the [HARMONY] button to enter the settings menu.
2. Use the [+ / YES] / [- / NO] buttons to change the harmony type.

Notes:

Harmony type "1+5" and "octave" are always available, but the rest will not respond until you turn on the A.B.C. function and then play a chord in the chord section.

Func	HARMONY				Duet
	TRANS	SIGNATURE	BAR TIME	TEMPO	MEMORY
	0	4/4	00 1:01	096	01-1
	A.B.C.				

Function Menu

1. Enter the function menu.
Press the [FUNCTION] button to enter the function menu. The LCD shows the current parameter.
2. Adjust the settings.
Use the data dial to select a parameter. Use the [+ / YES] / [- / NO] buttons to change the setting of the selected item. Press [+ / YES] and [- / NO] at the same time to restore the default setting.

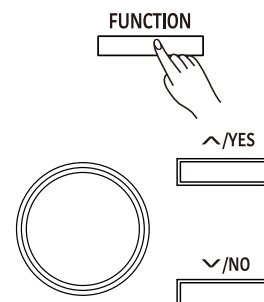

Note:

It will exit the function menu if there is no operation in 10 seconds.

Detailed parameters and their ranges:

No.	Parameter	LCD Display	Range	Default
1	Tune	TUNE	-50 ~ +50	0
2	Voice R1 Octave	OCTAVE R1	-2 ~ +2	0
3	Voice R2 Octave	OCTAVE R2	-2 ~ +2	0
4	Voice L Octave	OCTAVE L	-2 ~ +2	0
5	Touch Response	TOUCH	Off, Soft2, Soft1, Medium1, Medium2, Hard1, Hard2	Medium1
6	Chord Type	CHORD	Fingered, Multi, Bass Invert	Fingered
7	Lower Split Point	LOWER SPLIT	A0 ~ C8	F#3
8	Twinova Split Point	TWINOVA SPLIT	A0 ~ C8	E3
9	Twinova Octave	TWINOVA OCTAVE	-2 ~ 2	0
10	Harmony Type	HARMONY	Duet, Trio, Octave, 1+5, Country Duet, Block, 4 Close 1, 4 Close 2, 4 Open	Duet
11	EQ	EQ	Piano, Pop, Classical, Rock, Jazz, R&B	Piano
12	String Resonance	STRING RES.	0 ~ 32	8
13	Soft Pedal	SOFT PEDAL	Soft, Play, Memory	Soft
14	Freeze	FREEZE	Style, Voice, Song	Style
15	Metronome Time Signature	METRO	2/2 ~ 12/8	4/4
16	Fade In/Out Time	FADE TIME	1 ~ 20	10
17	MIDI Out Channel	MIDI OUT CH	1 ~ 16	1
18	Song Looping	SONG LOOP	Single, All, Off	All
19	Auto Power Off	POWER OFF	Never, 30 min, 60 min	30 min
20	System Time-Year	YEAR	2016 ~ 2100	2016
21	System Time-Month	MONTH	Jan. ~ Dec.	-
22	System Time-Day	DAY	1 ~ 31	-
23	System Time-Hour	HOUR	0 ~ 23	-
24	System Time-Minute	MINUTE	0 ~ 59	-
25	Bluetooth Auto Link	BLUETOOTH AUTO	On, Off	On
26	Restore Factory Setting	SYSTEM RESET	-	-

Function Menu

Tune

This function adjusts the pitch of the entire keyboard in 2-cent increments over a range of ± 50 (100 cents).

1. In the function menu, use the data dial to select "TUNE".
2. Use the [+ / YES] / [- / NO] buttons to change the tune value.

Func		TUNE				00
TRANS	SIGNATURE	BAR TIME	TEMPO	MEMORY		
0	4/4	00 1:0 1	096	0 1-1		
A.B.C.						

Octave

This function will shift the pitch of the specified voice layer up or down by one octave.

1. In the function menu, use the data dial to select "OCTAVE R1" / "OCTAVE R2" / "OCTAVE L".
2. Use the [+ / YES] / [- / NO] buttons to change the octave value.

Func		OCTAVE R1				00
TRANS	SIGNATURE	BAR TIME	TEMPO	MEMORY		
0	4/4	00 1:0 1	096	0 1-1		
A.B.C.						

Note:

The default octave setting of each preset voice may differ.

Touch Response

The touch response feature allows you to expressively control the voice level based on your playing dynamics, just as on an acoustic instrument.

1. In the function menu, use the data dial to select "TOUCH".
2. Use the [+ / YES] / [- / NO] buttons to change the setting.

Note:

Your setting will be automatically saved when you press [POWER] to turn off the instrument.

Func		TOUCH				Medium1
TRANS	SIGNATURE	BAR TIME	TEMPO	MEMORY		
0	4/4	00 1:0 1	096	0 1-1		
A.B.C.						

Chord Type

You can select a desired fingering type to play chords.

1. In the function menu, use the data dial to select "CHORD".
2. Use the [+ / YES] / [- / NO] buttons to select a fingering type.

Func		CHORD				Fingered
TRANS	SIGNATURE	BAR TIME	TEMPO	MEMORY		
0	4/4	00 1:0 1	096	0 1-1		
A.B.C.						

Lower Split Point

This function assigns a key to split the entire keyboard into two areas. When the A.B.C. function is in use, the left hand area controls the playback of auto accompaniment. When A.B.C. is disabled, the left hand area plays the lower voice.

1. In the function menu, use the data dial to select "LOWER SPLIT".
2. Use the [+ / YES] / [- / NO] buttons or press any key on the keyboard to assign the split point.

Func		LOWER SPLIT				F#3
TRANS	SIGNATURE	BAR TIME	TEMPO	MEMORY		
0	4/4	00 1:0 1	096	0 1-1		
A.B.C.						

Twinova Split Point / Octave

You can adjust the split point and octave for Twinova mode.

1. In the function menu, use the data dial to select "TWINOVA SPLIT" / "TWINOVA OCTAVE".
2. Use the [+ / YES] / [- / NO] buttons to change the setting.

Func		TWINOVA SPLIT				E3
TRANS	SIGNATURE	BAR TIME	TEMPO	MEMORY		
0	4/4	00 1:0 1	078	0 1-1		
A.B.C.						

Func		TWINOVA OCTAVE				0
TRANS	SIGNATURE	BAR TIME	TEMPO	MEMORY		
0	4/4	00 1:0 1	078	0 1-1		
A.B.C.						

Function Menu

Harmony Type

1. In the function menu, use the data dial to select "HARMONY".
2. Use the [+ / Yes] / [- / No] buttons to select a harmony type.

Detailed harmony types:

Harmony Type	LCD Display
Duet	Duet
Trio	Trio
Octave	Octave
1+5	1+5
Country Duet	CountryDuet
Block	Block
4 Close 1	4Close1
4 Close 2	4Close2
4 Open	4Open

Func	HARMONY				Duet
	TRANS	SIGNATURE	BAR TIME	TEMPO	MEMORY
	0	4/4	00 1:01	096	0 1-1

EQ

An EQ controls the gain value of different frequency bands. Different gain settings will produce different sound effects.

1. In the function menu, use the data dial to select "EQ".
2. Use the [+ / YES] / [- / NO] buttons to change the setting.

Func	EQ				Piano
	TRANS	SIGNATURE	BAR TIME	TEMPO	MEMORY
	0	4/4	00 1:01	096	0 1-1

String Resonance

When a piano voice is selected, pressing the sustain pedal will add a string resonance effect to the notes you play. The string resonance effect faithfully recreates the resonance from the strings and soundboard of an acoustic grand piano.

1. In the function menu, use the data dial to select "STRING RES.".
2. Use the [+ / YES] / [- / NO] buttons to change the setting.

Note:

Your setting will be automatically saved when you press [POWER] to turn off the instrument.

Func	STRING RES.				8
	TRANS	SIGNATURE	BAR TIME	TEMPO	MEMORY
	0	4/4	00 1:01	096	0 1-1

Soft Pedal

You can assign other pedal functions to the soft pedal.

1. In the function menu, use the data dial to select "SOFT PEDAL".
2. Use the [+ / Yes] / [- / No] buttons to select a pedal function.

Detailed pedal functions:

Pedal Function	Description
Soft	Press the pedal to make notes played on the keyboard sound softer.
Play	Press the pedal to start or stop playing the style.
Memory	Press the pedal to switch between the memories.

Func	SOFT PEDAL				SOFT
	TRANS	SIGNATURE	BAR TIME	TEMPO	MEMORY
	0	4/4	00 1:01	096	0 1-1

Function Menu

Freeze

When Freeze function is in use, the selected parameter setting will remain unchanged when a performance memory is recalled.

1. In the function menu, use the data dial to select "FREEZE".
2. Use the [+YES]/[-NO] buttons to select a parameter.

Note:

The setting will be usable only when Freeze function is in use.

Func	FREEZE					Style
	TRANS	SIGNATURE	BAR TIME	TEMPO	MEMORY	
	0	4/4	00 1:0 1	096	0 1-1	

Metronome Beat

1. In the function menu, use the data dial to select "METRO".
2. Use the [+YES]/[-NO] buttons to change the Beat.

Func	METRO					4/4
	TRANS	SIGNATURE	BAR TIME	TEMPO	MEMORY	
	0	4/4	00 1:0 1	096	0 1-1	

Fade Time

Set the time length (in seconds) for Fade In/Out.

1. In the function menu, use the data dial to select "FADE TIME".
2. Use the [+YES]/[-NO] buttons to change the time setting.

Func	FADE TIME					10
	TRANS	SIGNATURE	BAR TIME	TEMPO	MEMORY	
	0	4/4	00 1:0 1	096	0 1-1	

MIDI Out Channel

Set the MIDI OUT channel for Voice R1.

1. In the function menu, use the data dial to select "MIDI OUT CH".
2. Use the [+YES]/[-NO] buttons to change the MIDI Out channel.

Note:

Your setting will be automatically saved when you press [POWER] to turn off the instrument.

Func	MIDI OUT CH					01
	TRANS	SIGNATURE	BAR TIME	TEMPO	MEMORY	
	0	4/4	00 1:0 1	096	0 1-1	

Song Looping

You can play back songs in the following ways: looping all songs, looping a single song, or no looping (looping off).

1. In the function menu, use the data dial to select "SONG LOOP".
2. Use the [+YES]/[-NO] buttons to change the setting.

Note:

Your setting will be automatically saved when you press [POWER] to turn off the instrument.

Func	SONG LOOP					All
	TRANS	SIGNATURE	BAR TIME	TEMPO	MEMORY	
	0	4/4	00 1:0 1	096	0 1-1	

Auto Power Off

The instrument will automatically shut down after 30 minutes of inactivity, but you can disable this function or change the time setting.

1. In the function menu, use the data dial to select "POWER OFF".
2. Use the [+YES]/[-NO] buttons to change the time setting.

Note:

Your setting will be automatically saved when you press [POWER] to turn off the instrument.

Func	POWER OFF					30 min
	TRANS	SIGNATURE	BAR TIME	TEMPO	MEMORY	
	0	4/4	00 1:0 1	096	0 1-1	

Function Menu

System Time

You may want to set the correct system time, as it will appear on files saved to a USB flash drive and other applications.

1. In the function menu, use the data dial to select "YEAR" / "MONTH" / "DAY" / "HOUR" / "MINUTE".
2. Use the [+ / YES] / [- / NO] buttons to set the time.

Note:

Your setting will be automatically saved when you press [POWER] to turn off the instrument.

Func		YEAR			2016	
TRANS	SIGNATURE	BAR TIME	TEMPO	MEMORY		
0	4/4	00 1:0 1	096	0 1- 1		

Bluetooth Auto Link

This function decides whether Bluetooth connection is automatically linked or not. Once a Bluetooth device is successfully paired, it will automatically establish a connection when the device is in within range.

1. In the function menu, use the data dial to select "BLUETOOTH AUTO".
2. Use the [+ / YES] / [- / NO] buttons to change the setting.

Func		BLUETOOTH AUTO			On	
TRANS	SIGNATURE	BAR TIME	TEMPO	MEMORY		
0	4/4	00 1:0 1	096	0 1- 1		

Factory Reset

1. In the function menu, use the data dial to select "SYSTEM RESET".
2. Press [+ / YES]. The LCD will show "Reset all settings?"
3. Press [+ / YES] to confirm. Note: The operation will delete all user settings.
4. The LCD will show "Delete the user song?"
5. Press [+ / YES] to confirm. Note: The operation will delete all user songs.
6. The reset procedure may take several minutes to complete.

Note:

Do not turn off the power when factory reset is in progress, otherwise it may corrupt the internal data and cause malfunction.

Func		SYSTEM RESET				
TRANS	SIGNATURE	BAR TIME	TEMPO	MEMORY		
0	4/4	00 1:0 1	096	0 1- 1		

Performance Memory

This function is designed to make your performance easy and efficient. It allows you to save virtually all panel settings to a single performance memory for instant recall.

Note:

To reset the performance memory to factory default, press and hold both the [STORE] and [M1] buttons, then turn on the power. The operation will delete all user memory.

Registering the Panel Settings

Press and hold the [STORE] button, then press one of the [M1]-[M6] buttons. This will save the current panel settings to the selected memory.

Note:

This operation will overwrite any previous data.

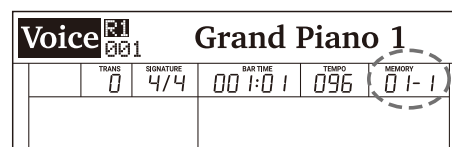
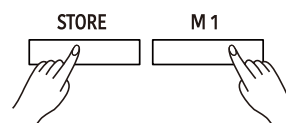

Recalling the Memory Settings

Press one of the [M1] - [M6] buttons to instantly recall the settings saved in that memory. This will reset the related parameters on the control panel.

Note:

Performance memory cannot be recalled when the O.T.S. function is in use.

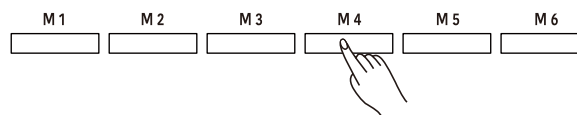

Selecting a Memory Bank

1. Press the [BANK] button. The LCD shows the current bank number.
2. Use the data dial to select a memory bank. You can also press the [BANK] button repeatedly to select a bank.

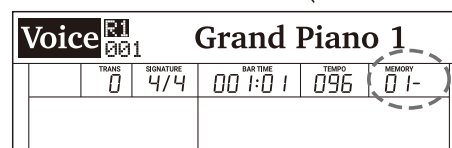
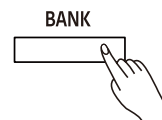

Freezing Specific Settings

When Freeze function is in use, specified panel parameters will remain unchanged even when a performance memory is recalled.

1. In memory mode, press the [FREEZE] button to turn on the function. The LED lights up.
2. Press the button again to turn off the function. The LED turns off.
3. Press and hold [FREEZE] to enter the settings menu. You can select to freeze voice, style, or song settings. Please refer to the **Function Menu** for details.



Song Recording

You can record your performance in two ways: MIDI recording and Audio recording.

MIDI Recording

In MIDI recording, you can record and save your keyboard performance as a user song on the instrument. You can then play it back and save it to a USB flash drive.

Prepare Recording

1. Press the [REC] button to enter recording standby mode. The Record button LED and the “REC” indicator will blink.

Note:

If a USB flash drive has been inserted, press and hold the [REC] button to enter the Recording settings menu, then set the Record Type to “MIDI”. You can select to save the MIDI recording to either the internal flash memory or the connected USB flash drive. Please refer to **Recording Settings** for details.

After configuring the settings, press the [REC] button to enter recording standby mode.

2. In recording standby mode, you can set the instrument voice, song style, tempo and so on.
3. In recording standby mode, press the [REC] button again to exit recording.

Start Recording

In recording standby mode, press the [START/STOP] button or simply play the keyboard to start recording. The [REC] button LED and the “REC” indicator stop blinking and stay lit.

Alternatively, you can turn on the Sync Start function, then play the keyboard to start recording.

Stop Recording

1. During recording, press the [REC] button to stop recording. The Record button LED and the “REC” indicator will turn off.
2. If the memory gets full during recording, recording will stop and be saved automatically.

Play back Recording

1. During recording, if you press the [REC] button to stop recording, it will enter Song mode and show the recorded song. Press the [START/STOP] button to play back the user song.
2. In standby mode, press the [SONG] button to enter Song mode, then use the [+ / YES] / [- / NO] buttons to select the user song. Press the [START/STOP] button to play back the song.

Recording Settings

1. Press and hold the [REC] button to enter the Recording settings menu.
2. Use the data dial to select a parameter.
3. Use the [+ / YES] / [- / NO] buttons to change the settings.
4. After configuring the settings, follow the normal procedures to enter Recording mode.

28

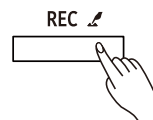

Voice 001		Grand Piano 1			
REC	TRANS	SIGNATURE	BAR TIME	TEMPO	MEMORY
REC	0	4/4	00 1:01	096	01-1

Song 161		User Song			
REC	TRANS	SIGNATURE	BAR TIME	TEMPO	MEMORY
REC	0	4/4	00 1:01	096	01-1

Rec Record Type:		MIDI			
REC	TRANS	SIGNATURE	BAR TIME	TEMPO	MEMORY
REC	0	4/4	00 1:01	096	01-1

Song Recording

Parameter	LCD Display	Range
Record Type Setting	Record Type: xxx	MIDI, MP3
MIDI Recording Channel 1	Ch1:R1 xxx	On, Off
MIDI Recording Channel 2	Ch2:R2 xxx	On, Off
MIDI Recording Channel 3	Ch3:L xxx	On, Off
MIDI Recording Channel 4	Ch4:MIDI Ch4 xxx	On, Off
MIDI Recording Channel 5	Ch5:MIDICh5 xxx	On, Off
MIDI Recording Channel 6	Ch6:MIDICh6 xxx	On, Off
MIDI Recording Channel 7	Ch7:MIDICh7 xxx	On, Off
MIDI Recording Channel 8	Ch8:MIDICh8 xxx	On, Off
MIDI Recording Channel 9	Ch9:Rhythm_s xxx	On, Off
MIDI Recording Channel 10	Ch10:Rhythm_m xxx	On, Off
MIDI Recording Channel 11	Ch11:Bass xxx	On, Off
MIDI Recording Channel 12	Ch12:Chord1 xxx	On, Off
MIDI Recording Channel 13	Ch13:Chord2 xxx	On, Off
MIDI Recording Channel 14	Ch14:Chord3 xxx	On, Off
MIDI Recording Channel 15	Ch15:Phrase1 xxx	On, Off
MIDI Recording Channel 16	Ch16:Phrase2 xxx	On, Off
Saving the MIDI Recording To	MIDI Save To: xxx	Internal Flash, USB Flash

Note:

- The settings of the first and the last items above cannot be changed until a USB flash drive is inserted. Please refer to **Connecting USB Flash Drive** for details.
- If you have used the DSP effects during MIDI recording, when you play back the MIDI file, the preset DSP effects for voice R1/ R2/ L will be disabled and the relevant DSP Types will be set to OFF and cannot be changed. The DSP effects for the voice layers will work again only when you pause, stop or exit MIDI playback.
- If you use channel 4 - 8 for recording, connect an external MIDI keyboard or other MIDI device via either the USB jack or the MIDI jack, and then set the device's MIDI Out channels accordingly.

Audio Recording

Audio recording will record your performance and save it to a USB flash drive as an MP3 file. During recording, the sounds and effects you hear from the instrument will all be recorded.

- Connect a USB flash drive to the instrument, then wait until the USB indicator appears on the LCD.
- Press the [REC] button to start recording. The Record button LED and "REC" indicator will light up.

Note:

If you want to switch to MIDI recording, press and hold the [REC] button to enter the Recording settings menu, then set the Record Type to "MIDI". Please refer to **Recording Settings** for details.

- During recording, you can play back style accompaniment, play the keyboard, play back songs or demos, play back music from the AUX IN jack, and sing through a microphone. All these sounds will be recorded.
- During recording, press the [REC] button to stop recording. The recording button LED and the "REC" indicator will turn off.
- The recorded song will be automatically saved as "AudioRec XXX". Press the [START/STOP] button to play back the song.

Note:

Do not remove the USB flash drive or turn off the power when song saving is in progress, otherwise it may cause damage to the audio files and the USB flash drive.

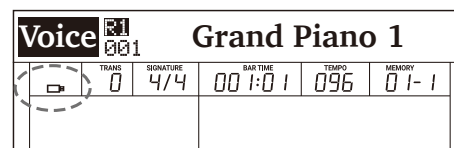

REC

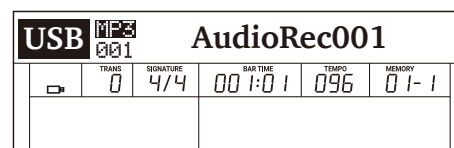
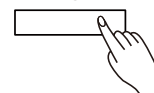

Song

The instrument features several complete piano songs. Please refer to the **Song List** for details.

Play the Songs

1. Press the [SONG] button to enter Song mode. The LCD shows the current song number and name.
2. Use the data dial or [+ / YES] / [- / NO] buttons to select a desired song.
3. Press the [START / STOP] button to start or stop song playback.

SONG/0

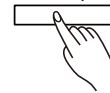

Song		001 Red River Valley			
TRANS	SIGNATURE	BAR TIME	TEMPO	MEMORY	
0	4/4	00 1:01	095	0 1-1	

Notes:

1. You can set to playing a single song or all songs in a loop. Please refer to the **Function Menu** for details.
2. When Bluetooth connection is activated, press the [SONG] button once to enter Bluetooth mode, then press it again to switch to Song mode.

Control the Song Playback

1. Fast Forward, Rewind or Pause the Playback
During song playback:
Press the [▶▶] button to fast forward the song.
Press the [◀◀] button to rewind the song (based on the measure).
Press the [||] button to pause the song. Press it again to continue the playback.
2. Song Looping
Press [↺] button when playing songs to play the current song in a loop.
Press [↻] button when playing songs to play all the songs in a loop.



Practice the Songs

All the preset songs can be practiced with melody-off.

1. Press the [LEFT] button to mute the left-hand melody. The "L-OFF" indicator will light up. You can then practice the left hand melody of the song.
2. In the same way, press the [RIGHT] button to mute the right-hand melody. The "R-OFF" indicator will light up. You can then practice the right hand melody of the song.

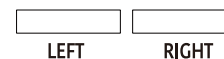

Song		L-OFF 001 Red River Valley			
TRANS	SIGNATURE	BAR TIME	TEMPO	MEMORY	
0	4/4	00 1:01	095	0 1-1	

Song		R-OFF 001 Red River Valley			
TRANS	SIGNATURE	BAR TIME	TEMPO	MEMORY	
0	4/4	00 1:01	095	0 1-1	

Bluetooth

Bluetooth Pairing

1. The Bluetooth function is turned on by default.
2. You can pair the Bluetooth Audio function of the instrument with an external mobile device.
Bluetooth Audio Name: Piano-Audio
After it is paired, the instrument will remember that device and automatically pair it when the mobile device is within range. You can disable Bluetooth Auto Link in the function menu.
Please refer to the Function Menu for details.
3. To use the Bluetooth MIDI function, you may need to select you instrument in the MIDI device interface of compatible external devices.
Bluetooth MIDI name: Piano-MIDI

Playing the Bluetooth Songs

1. After the device is paired, the Bluetooth indicator will appear on the LCD. Press the [SONG/🎵] button to enter Bluetooth mode.
2. Press the [START/STOP] button to start or stop playing Bluetooth music.
3. Select a song to play over Bluetooth.
Press [▶▶] button to play the previous song.
Press [◀◀] button to play the next song.
In Bluetooth mode, you can also use the [+ / YES] / [- / NO] buttons to select a desired song from your Bluetooth connected device.

SONG/🎵

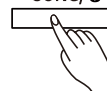

🎵 Song		Bluetooth Music				
	TRANS	SIGNATURE	BAR TIME	TEMPO	MEMORY	
🎵	0	4/4	00 1:01	095	01-1	

Disable the Bluetooth Connection

1. Use the data dial to select "Disconnect", then press [+ / YES]. The LCD will prompt "Disconnect Bluetooth?"
2. Press [+ / YES] to confirm and disable the Bluetooth connection.

Note:

In Bluetooth mode, you can press the [SONG] button to switch to Song mode.

🎵 Song		Disconnect				
	TRANS	SIGNATURE	BAR TIME	TEMPO	MEMORY	
🎵	0	4/4	00 1:01	095	01-1	

Connecting USB Flash Drive

The instrument recognizes USB flash drives (32M to 128G) in FAT32 format. It does not support multi-partitioned USB flash drives. We recommend formatting the USB flash drive on the instrument before using.

Note:

A USB flash drive in FAT32 format supports up to 512 files under its root directory. Exceeding this limit will make it unable to save or record to the USB flash drive.

Playing

1. Press the [USB] button to enter the USB Play menu. The LCD shows all MIDI and MP3 songs under the root directory of the USB flash drive.
2. Use the data dial or [+ / YES] [- / NO] buttons to select a song.
3. Press the [START / STOP] button to start playback. You can set to loop play a single song or all songs. Please refer to the **Function Menu** for details.
4. Press the [START / STOP] button again to stop playback.

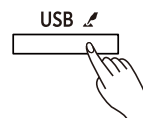

USB		AudioRec001				
	TRANS	SIGNATURE	BAR TIME	TEMPO	MEMORY	
001	0	4/4	00:1:01	096	01-1	

Saving

1. Press and hold the [USB] button to enter the USB menu. Use the data dial to select "Save MIDI".
2. Press [+ / YES] to save the user song to the root directory of the USB flash drive. The file will be saved as "UserSong00X_YYMMDD_NUB.MIDI". If the user song is empty, the LCD will prompt "NoFile!".
3. After saving, the LCD will prompt "User song save successful!", then return to the USB menu.

USBMenu		Save MIDI				
	TRANS	SIGNATURE	BAR TIME	TEMPO	MEMORY	
0	0	4/4	00:1:01	096	01-1	

File Name Description:

"UserSong00X" is the user song name and number (corresponds to the user song on the instrument).

"YYMMDD" is the year, month and date the song was saved.

"NUB" is the track number of the saved song (001~512).

Loading

1. Press and hold the [USB] button to enter the USB menu. Use the data dial to select "Load MIDI".
2. Press [+ / YES]. The LCD will show all MIDI files (*.mid) under the root directory. Use the data dial to select one.
3. Press the [+ / YES] button. The LCD will prompt "Load MIDI Successful!". If the user song on the instrument is not empty, the LCD will prompt "Over-write the User Song?" Press the [+ / YES] button to confirm loading or press [- / NO] to cancel.
4. After loading, the LCD will return to the USB menu.

USBMenu		Load MIDI				
	TRANS	SIGNATURE	BAR TIME	TEMPO	MEMORY	
0	0	4/4	00:1:01	096	01-1	

Note:

This operation will overwrite the previous user song on the instrument.

Formatting

1. Press and hold the [USB] button to enter the USB menu. Use the data dial to select "Format USB".
2. Press [+ / YES]. The LCD will prompt "Format USB Flash Drive?".
3. Press [+ / YES] to format the flash drive or press [- / NO] to cancel.
4. After formatting, it will return to the USB menu.

Notes:

1. Formatting will delete all data on the USB flash drive!
2. It may take several minutes to format a USB flash drive of large capacity.

USBMenu		Format USB				
	TRANS	SIGNATURE	BAR TIME	TEMPO	MEMORY	
0	0	4/4	00:1:01	096	01-1	

The MIDI function will expand your musical possibilities.

What's MIDI?

MIDI (short for Musical Instrument Digital Interface) allows a wide variety of electronic musical instruments, computers and other related devices to connect and communicate with one another. MIDI carries event messages that specify notation, pitch and velocity, controls signals for parameters such as volume, vibrato, audio panning, and programs change information to change the voice selections.

The instrument can output real-time playback information via MIDI messages and control external MIDI devices. The instrument can also accept incoming MIDI messages and generate sound accordingly.

Troubleshooting

Problem	Possible Cause and Solution
The speakers produce a pop sound whenever the power is turned ON/OFF.	This is normal and is no cause for alarm.
Speakers do not produce sound when the keyboard is played.	<ol style="list-style-type: none"> 1. Check if the master volume is set too low. 2. Check if headphones are plugged into the PHONES jack. 3. Check if the R1/R2/L1 voice volume is set too low (in the Mixer).
There is noise when I use a mobile phone.	Using a mobile phone in close proximity to the instrument may produce interference. To prevent this, turn off the mobile phone or keep it away from the instrument when in use.
The auto accompaniment does not play back even when Sync is in standby and a key is pressed.	You may be playing keys in the right hand range of the keyboard. To start the accompaniment with Sync Start, make sure to play keys in the left-hand range.
Certain notes seem to be in the wrong pitch.	Make sure that the tune value is set to 0. Hold down the [+ / YES] and [- / NO] buttons and turn on the power to restore factory settings.
When connecting to computer, the instrument cannot be recognized.	Check if the USB cable is firmly connected. Try connecting another USB port on the computer. This instrument is plug and play and should work without installing a driver.
The pedal does not respond.	Check if the pedal cable is firmly connected.
It cannot read/save to the USB flash drive.	Make sure your USB flash drive is in FAT32 format and not multi-partitioned.
It shuts down after a period of time.	The auto power off function will turn off the instrument after a preset period of time when the instrument is not in use. You can adjust the auto-off function in the Function Menu.

Specifications

Keyboard & Display	
Keyboard	88 Graded Hammer-Action Keys with Triple Sensors
Touch Response	6 types, Off
Display	Multi-functional LCD
Voices	
Polyphony (max.)	256
Voices	1200 panel, 13 drum kits
Layer	Left, Right1, Right2
Split	Yes
Duo (Twinova)	Yes
Styles	
Styles	270 presets
Style Control	Start / Stop Sync start Sync stop Intro 1 / Ending 1 Intro 2 / Ending 2 Main A / Fill in A Main B / Fill in B Main C / Fill in C Main D / Fill in D A.B.C. Fade in/out
Style Creator	—
O.T.S.	Yes
Chord Types	32
Effects	
Effects	DSP on / off; Second-generation Acoustic Piano String Resonance Simulation
Master EQ	6 types
Reverb	11 types
Chorus	12 types
Voice Effect	15 types
Performance Enhance	
Harmony	9 types
Song & Recording	
Music Library	90 preset songs; L / R hand learning
Sequencer	1 user song (16 tracks)
Demo Song	3
Audio Playback	MP3
Audio Recorder	MP3
Score Display	—
Pitch Adjustment	
Transpose	-12 ~ +12
Octave	-2 ~ +2
Tuning	-50 ~ +50
Other Functions	
Mixer	Yes (14 tracks)
Performance Memory	32 preset banks x 6
Assignable Controllers	Soft pedal
Pitch Bend	—
Modulation	—
Metronome	Yes
Tempo	30 ~ 280
Other control	Piano mode; Brilliance; Bluetooth Audio/MIDI

Specifications

Connections	
Interaction & Expansion	USB MIDI, USB Audio, Bluetooth
External Drive	USB flash drive (128G max)
Microphone	YES (Mic effect: 12 types)
Phones	2 Standard Stereo
Pedals	Sustain, Soft, Sostenuto
MIDI	In, Out
USB	USB Audio & MIDI
Input	Standard Stereo
Output	Standard Stereo
Power Supply	
Power	DC 15V / 2.5A
Power Off Protection	Yes
Amplifiers & Speakers	
Amplifiers	25W x 2, 15W x 2
Speakers	40W x 2, 25W x 2
Dimensions & Weight	
Dimensions LWH (mm)	1400 x 494 x 910
Weight (kg)	58

* All specifications and appearances are subject to change without notice.

Voice List

No.	Voice Name	LCD Name
Piano		
1	Acoustic Grand Piano 1	Grand Piano 1
2	Acoustic Grand Piano 2	Grand Piano 2
3	Bright Acoustic Piano (wide) 1	Bright Pno/Wide 1
4	Acoustic Grand Piano (dark) 1	Grand Piano/Dark 1
5	Rock Piano	Rock Piano
6	Honky Tonk Piano (wide) 1	Honky Tonk/Wide 1
7	Octave Grand Piano 1	Octave Piano 1
8	Octave Grand Piano 2	Octave Piano 2
9	Grand Piano/Live	Grand Piano/Live
10	Bright Acoustic Piano 1	Bright Piano 1
11	Grand Piano (Warm)	Grand Piano/Warm
12	Octave Grand Piano 3	Octave Piano 3
13	Octave Grand Piano 4	Octave Piano 4
14	Honky Tonk Piano 1	Honky Tonk 1
15	Harpsichord (Live)	Harpsichord/Live
16	Harpsichord (Octave) 1	Harpsi/Octave 1
17	Harpsichord 1	Harpsichord 1
18	Electric Grand Piano 1	Electric Grand 1
19	Electric Grand Piano 2	Electric Grand 2
20	Pop Piano	Pop Piano
21	Piano & Strings 1	Piano&Strings 1
22	Piano & Pad 1	Piano&Pad 1
23	Piano & Choir 1	Piano&Choir 1
24	Piano & EP 1	Piano&EP 1
25	Piano & EP 2	Piano&EP 2
26	Electric Grand Piano 3	Electric Grand 3
27	Harpsichord (Octave) 2	Harpsi/Octave 2
28	Harpsichord & Strings	Harpsi&Strings
29	Electric Grand Piano 4	Electric Grand 4
Electric Piano		
30	Electric Piano 1	E.Piano 1
31	Electric Piano 2	E.Piano 2
32	Modern Electric Piano 1	Modern EP 1
33	Jazz Electric Piano 1	Jazz EP 1
34	Modern Electric Piano 2	Modern EP 2
35	Jazz Electric Piano 2	Jazz EP 2
36	Phase Electric Piano 1	Phase EP 1
37	Vintage Electric Piano 1	Vintage EP 1
38	Funk EP 1	Funk EP 1
39	Vintage Electric Piano 2	Vintage EP 2
40	Classic Electric Piano 1	Classic EP 1
41	Electric Piano 3	E.Piano 3
42	Tremolo EP 1	Tremolo EP 1
43	Funk EP 2	Funk EP 2
44	60's Electric Piano 1	60's EP 1
45	Vintage Electric Piano 3	Vintage EP 3
46	Warm Electric Piano	Warm EP
47	Tremolo EP 3	Tremolo EP 3
48	Electric Piano 4	E.Piano 4
49	Modern Electric Piano 3	Modern EP 3
50	Tremolo EP 2	Tremolo EP 2
51	Classic Electric Piano 2	Classic EP 2
52	Sereo Clavi	Sereo Clavi
53	Phase Clavi	Phase Clavi

54	Clavi 1	Clavi 1
55	Wah Clavi 1	Wah Clavi 1
56	Clavi 2	Clavi 2
57	Wah Clavi 2	Wah Clavi 2
58	Massiness Electric Piano	Massiness EP
59	Wah Electric Piano	Wah EP
60	Bright Electric Piano	Bright EP
61	Dark Electric Piano	Dark EP
62	Wire Electric Piano	Wire EP
63	Aah Electric Piano	Aah EP
64	Overdriven Electric Piano	Overdriven EP
65	Modern Jazz Electric Piano	Modern Jazz EP
66	Jump Electric Piano	Jump EP
67	Warm Jump Electric Piano	Warm Jump EP
68	Metallic Electric Piano 1	Metallic EP 1
69	Metallic Electric Piano 2	Metallic EP 2
70	Rock Electric Piano	Rock EP
71	Pop Electric Piano	Pop EP
72	Crysta Electric Piano	Crysta EP
73	Crysta Jazz Electric Piano	Crysta Jazz EP
74	Rock Electric Clavi	Rock Elec Clavi
75	Jazz Electric Clavi	Jazz Elec Clavi
76	Pop Electric Clavi	Pop Elec Clavi
77	Aahs Electric Clavi	Aahs Elec Clavi
78	Bright Electric Clavi	Bright Elec Clavi
79	Warm Electric Clavi	Warm Elec Clavi
80	Echo Electric Clavi	Echo Elec Clavi
81	Dark Electric Clavi	Dark Elec Clavi
Organ		
82	Drawbar Organ 1	Draw Org 1
83	Percussive Organ 1	Perc Org 1
84	Rock Organ 1	Rock Org 1
85	Church Organ 1	Church Org 1
86	Detuned Church Organ 1	Det Church Org 1
87	Percussive Organ 2	Perc Org 2
88	Detuned Percussive Organ 1	Det Prec Org 1
89	Rotary Organ 1	Rotary Org 1
90	Church Organ (octave mix) 1	ChurchOrg/Octave 1
91	Rock Organ 2	Rock Org 2
92	Detuned Organ	Detuned Org
93	Rotary Organ 2	Rotary Org 2
94	Pop Organ	Pop Org
95	Classic Organ 1	Classic Org 1
96	Jazz Organ 1	Jazz Org 1
97	Rock Organ 3	Rock Org 3
98	Rotary Organ 3	Rotary Org 3
99	Classic Organ 2	Classic Org 2
100	Detuned Drawbar Organ	Detuned DrawOrg
101	Italian 60's Organ 1	60's Org 1
102	Rock Organ 4	Rock Org 4
103	Percussive Organ 3	Perc Org 3
104	Drawbar Organ 2	Drawbar Org 2
105	Classic Organ 3	Classic Org 3
106	Italian 60's Organ 2	60's Org 2
107	Drawbar Organ 3	Drawbar Org 3
108	Vintage Organ 1	Vintage Org 1

Voice List

109	Vintage Organ 2	Vintage Org 2
110	Detuned Church Organ 2	Det Church Org 2
111	Mellow Organ 1	Mellow Org 1
112	Mellow Organ 2	Mellow Org 2
113	Mellow Organ 3	Mellow Org 3
114	Mellow Organ 4	Mellow Org 4
115	Organ 1	Organ 1
116	Organ 2	Organ 2
117	Organ 3	Organ 3
118	Reed Organ 1	Reed Org 1
119	Puff Organ 1	Puff Org 1
120	Dark Drawbar Organ	Dark Drawbar Organ
121	Soft Drawbar Organ	Soft Drawbar Org
122	Soft 60's Organ	Soft 60's Org
123	Bright 60's Organ	Bright 60's Org
124	Detuned Classic Organ	Det Classic Org
125	Mellow Rotary Organ	Mellow Rot Org
126	Dark Rotary Organ	Dark Rotary Org
127	Bright Rotary Organ	Bright Rot Org
128	Bright Percussive Organ	Br Perc Org
129	Jazz Percussive Organ	Jazz Perc Org
130	Rock Percussive Organ	Rock Perc Org
131	Octave Percussive Organ	Octave Perc Org
132	Mellow Percussive Organ	Mellow Perc Org
133	Puff Percussive Organ	Puff Perc Org
134	Pop Percussive Organ	Pop Perc Org
135	Reed Percussive Organ	Reed Perc Org
136	Vintage Rock Organ	Vintage Rock Org
137	Dark Rock Organ	Dark Rock Org
138	Mellow Rock Organ	Mellow Rock Org
139	Soft Rock Organ	Soft Rock Org
140	Reed Rock Organ	Reed Rock Org
141	Rotary Rock Organ	Rotary Rock Org
142	Wah Rock Organ	Wah Rock Org
143	Puff Rock Organ	Puff Rock Org
144	Bright Vintage Organ	Bright Vintage Org
145	Dark Vintage Organ	Dark Vintage Org
146	Mellow Vintage Organ	Mellow Vintage Org
147	Rotary Vintage Organ	Rotary Vintage Org
148	Rock Vintage Organ	Rock Vintage Org
149	Pop Vintage Organ	Pop Vintage Org
150	Soft Vintage Organ	Soft Vintage Org
151	Percussive Vintage Organ	Per Vintage Org
152	Dark Reed Organ	Dark Reed Org
153	Jazz Reed Organ	Jazz Reed Org
154	Pop Reed Organ	Pop Reed Org
155	Puff Reed Organ	Puff Reed Org
156	Rock Reed Organ	Rock Reed Org
157	Rotary Puff Organ	Rot Puff Org
158	Jazz Puff Organ	Jazz Puff Org
159	Pop Puff Organ	Pop Puff Org
160	Musette	Musette
161	Accordion 1	Accordion 1
162	Tango Accordion 1	Tango Accordion 1
163	Accord It Solo 1	Accord It Solo 1
164	Tango Accordion 2	Tango Accordion 2

165	Chorus Accordion	Chorus Accordion
166	Accordion 2	Accordion 2
167	Accord It Solo 2	Accord It Solo 2
168	Harmonica 1	Harmonica 1
169	Harmonica 2	Harmonica 2
170	Wah Harmonica	Wah Harmonica
171	Dark Musette	Dark Musette
172	Bright Musette	Bright Musette
173	Chorus Musette	Chorus Musette
174	Musette 2	Musette 2
175	Aah & Musette	Aah & Musette
176	Voice Oohs & Musette	Voice Ohs & Musette
177	Voice Oohs & Dark Musette	Ohs & Dk Muset
178	Dark Harmonica	Dark Harmonica
179	Bright Harmonica	Bright Harmonica
180	Chorus Harmonica	Chorus Harmonica
181	Harmonica 3	Harmonica 3
182	Aah & Harmonica	Aah & Harmonica
183	Voice Oohs & Harmonica	Voice Ohs & Harm
184	Voice Oohs & Dark Harmonica	Vc Ohs & Dk Harm
185	Dark Accordion	Dark Accordion
186	Bright Accordion	Bright Accordion
187	Chorus Accordion	Chorus Accordion
188	Aah & Accordion	Aah & Accordion
189	Voice Oohs & Accordion	Voice Oohs & Accd
190	Voice Oohs & Dark Accordion	Vc Ohs & Dk Accd
191	Accordion 3	Accordion 3
Guitar & Bass		
192	Nylon Guitar	Nylon Guitar
193	Steel Guitar 1	Steel Guitar 1
194	Jazz Guitar 1	Jazz Guitar 1
195	Clean Guitar 1	Clean Guitar 1
196	Steel Guitar 2	Steel Guitar 2
197	Mandolin	Mandolin
198	Funk Guitar 1	Funk Guitar 1
199	Velocity Clean Guitar	Velocity CleanGtr
200	Lead Guitar 1	Lead Guitar 1
201	Velocity Lead Guitar	Velocity LeadGtr
202	Lead Guitar 2	Lead Guitar 2
203	Overdriven Guitar 1	OverdrivenGtr 1
204	Tremolo clean Guitar	Tremolo cleanGtr
205	12-String Guitar	12String Guitar
206	Steel Guitar 3	Steel Guitar 3
207	Clean Guitar 2	Clean Guitar 2
208	Feedback Guitar 1	Feedback Guitar 1
209	5th Distortion	5th Distortion
210	Velocity Steel Guitar	Velocity SteelGtr
211	Delay Guitar 1	Delay Guitar 1
212	Vintage Guitar 1	Vintage Guitar 1
213	Jazz Guitar 2	Jazz Guitar 2
214	Rhythm Guitar	Rhythm Guitar
215	Jazz Lead 1	Jazz Lead 1
216	Vintage Guitar 2	Vintage Guitar 2
217	Classic Guitar	Classic Guitar
218	Jazz Lead 2	Jazz Lead 2
219	Vintage Guitar 3	Vintage Guitar 3

Voice List

220	Folk Guitar	Folk Guitar
221	Chorus Guitar 1	Chorus Guitar 1
222	Muted Guitar 1	Muted Guitar 1
223	Pedal Guitar	Pedal Guitar
224	Distortion Guitar 1	DistortionGtr 1
225	Chorus Guitar 2	Chorus Guitar 2
226	Tremolo Guitar 1	TremoloGuitar 1
227	Octave Guitar	OctaveGuitar
228	Chorus Guitar 3	Chorus Guitar 3
229	Tremolo Guitar 2	TremoloGuitar 2
230	Metal Guitar	Metal Guitar
231	Clean Guitar 3	Clean Guitar 3
232	Wah Guitar	Wah Guitar
233	Jazz Guitar & EP	JazzGtr&EP
234	Distortion Guitar 2	DistortionGtr 2
235	12-String Electric Guitar	12StrE.Guitar
236	Feedback Guitar 2	Feedback Guitar 2
237	12-String Guitar 1	12String Guitar 1
238	Muted Guitar 2	Muted Guitar 2
239	Funk Guitar 2	Funk Guitar 2
240	Overdriven Guitar 2	OverdrivenGtr 2
241	12-String Guitar 2	12String Guitar 2
242	Nylon Guitar & Acoustic Bass	NyGt&AcBass
243	Steel Guitar & Finger Bass	SteGt&FgBass
244	Chorus Steel Guitar	Chorus Ste Gt
245	Soft Chorus Steel Guitar	Soft Cho Ste Gt
246	Dark Chorus Steel Guitar	Dk Cho Ste Gt
247	Nylon Guitar & Steel Guitar	Ny Gt & Ste Gt
248	Jazz Guitar & Steel Guitar	Jazz Gt & Ste Gt
249	Distortion Steel Guitar	Dt Steel Guitar
250	Dark Steel Guitar	Dark Steel Gt
251	Warm Steel Guitar	Warm Steel Gt
252	Chorus Jazzy Guitar	Chorus Jazzy Gt
253	Bright Jazzy Guitar	Bright Jazzy Gt
254	Overdriven Jazzy Guitar	Over Jazzy Gt
255	Distortion Jazzy Guitar	Dist Jazzy Gt
256	Overdriven Octave Guitar	Over Octave Gt
257	Wah Octave Guitar	Wah Octave Gt
258	Jazz Octave Guitar	Jazz Octave Gt
259	Chorus Octave Guitar	Cho Octave Gt
260	Chorus Vintage Guitar	Cho Vintage Gt
261	Vintage Funk Guitar	Vintage Funk Gt
262	Overdriven Funk Guitar	Ovrdriv Funk Gt
263	Chorus Wah Guitar	Chorus Wah Gt
264	Clean Vintage Guitar	Clean Vintage Gt
265	Dark Vintage Guitar	Dark Vintage Gt
266	Bright Vintage Guitar	Brt Vintage Gt
267	Soft Vintage Guitar	Soft Vintage Gt
268	Dark Mute Guitar	Dark Mute Gt
269	Chorus Mute Guitar	Chorus Mute Gt
270	Overdrive Mute Guitar	Overdrive Mute Gt
271	Distortion Mute Guitar	Dist Mute Gt
272	Wah Mute Guitar	Wah Mute Gt
273	Pulse Mute Guitar	Pulse Mute Gt
274	Nylon Mute Guitar	Nylon Mute Gt
275	Funk Mute Guitar	Funk Mute Gt

276	Dark Overdrive Guitar	Dark Over Gt
277	Bright Overdrive Guitar	Bright Over Gt
278	Soft Overdrive Guitar	Soft Over Gt
279	Delay Overdrive Guitar	Delay Over Gt
280	Delay Feedback Guitar	Delay Feedback Gt
281	Chorus Feedback Guitar	Cho Feedback Gt
282	Wah Overdrive Guitar	Wah Over Gt
283	Dark Wah Overdrive Guitar	Dark Wah Over Gt
284	Chorus Distortion Guitar	Chorus Dist Gt
285	Dark Distortion Guitar	Dark Dist Gt
286	Wah Distortion Guitar	Wah Dist Gt
287	Velocity Lead Guitar 3	Velocity Lead Gt 3
288	Soft Distortion Guitar	Soft Dist Gt
289	Bright Lead Guitar 3	Bright Lead Gt 3
290	Modern Distortion Guitar	Modern Dist Gt
291	Delay Distortion Guitar	Delay Dist Gt
292	Finger Bass 1	Finger Bass 1
293	Acoustic Bass 1	Acoustic Bass 1
294	Pick Bass 1	Pick Bass 1
295	Fretless Bass 1	Fretless Bass 1
296	Slap Bass 1	Slap Bass 1
297	Resonant Bass	Resonant Bass
298	Attack Pulse	Attack Pulse
299	Resonant Bass 2	Resonant Bass 2
300	Analog Bass 1	Analog Bass 1
301	Resonance SynBass	Resonance SynBass
302	Rock Bass	Rock Bass
303	Fretless Bass 2	Fretless Bass 2
304	Pick Bass 2	Pick Bass 2
305	Finger Slap Bass	Finger Slap Bass
306	Acoustic Bass & Cymbal	Bass & Cymbal
307	Analog Bass 2	Analog Bass 2
308	Resonant Slap Bass	Resonant SlapBass
309	Warm Synth Bass 1	Warm Syn Bass 1
310	Hammer 1	Hammer 1
311	Synth Bass (rubber)	Synth Bass (rubber)
312	Power Slap Bass	Power Slap Bass
313	Finger Bass 2	Finger Bass 2
314	Warm Synth Bass 2	Warm Syn Bass 2
315	Mute Pick Bass	Mute Pick Bass
316	Attack Pulse 2	Attack Pulse 2
317	Bright Finger Bass	Brt Finger Bass
318	Overdriven Finger Bass	Over Finger Bass
319	Distortion Finger Bass	Dt Finger Bass
320	Distortion Guitar & Finger Bass	Dt Gt & Fngr Ba
321	Wah Finger Bass	Wah Finger Bass
322	Finger Slap Bass 2	Fngr Slap Bass 2
323	Soft Wah Slap Bass	Soft Wah Slap Ba
324	Dark Slap Bass	Dark Slap Bass
325	Bright Pick Bass	Bright Pick Bass
326	Dark Pick Bass	Dark Pick Bass
327	Overdriven Pick Bass	Over Pick Bass
328	Distortion Guitar&Pick Bass	DtGt&Pick Bass
329	Wah Pick Bass	Wah Pick Bass
330	Chorus Pick Bass	Cho Pick Bass
331	Warm Chorus Pick Bass	Warm Cho Pick Ba

Voice List

332	Rock Bass 2	Rock Bass 2
333	Bright Fretless Bass	Brt Fret Bass
334	Overdriven Fretless Bass	Over Fret Bass
335	Distortion Fretless Bass	Dist Fret Bass
336	Wah Fretless Bass	Wah Fret Bass
337	Mute Fretless Bass	Mute Fret Bass
338	Dark Fretless Bass	Dark Fret Bass
339	Pick Mute Fretless Bass	Pick Mu Fret Bass
340	Slap Fretless Bass	Slap Fret Bass
341	Dark Slap Bass	Dark Slap Bass
342	Chorus Slap Bass	Chorus Slap Bass
343	Distortion Guitar & Slap Bass	DtGt & Slap Bass
344	Bright Resonant Slap Bass	Bt Rt Slap Bass
345	Dark Resonant Slap Bass	Dk Rt Slap Bass
346	Chorus Resonant Slap Bass	Chs Rt Slap Bass
347	Wah Resonant Slap Bass	Wah Rt Slap Bass
348	Warm Resonant Slap Bass	Warm Rt Slap Ba
349	Dark Power Slap Bass	Dk Power Slap Ba
350	Bright Power Slap Bass	Bt Power Slap Ba
351	Distortion Power Slap Bass	Dt Power Slap Ba
352	Distortion Guitar & Power Slap Bass	DtGt & PowrSlpBa
353	Overdriven Guitar & Power Slap Bass	OvGt & PowrSlpBa
354	Chorus Power Slap Bass	Cho Powr Slp Ba
355	Wah Power Slap Bass	Wah Powr Slp Ba
356	Warm Power Slap Bass	Warm Powr Slp Ba
357	Dark Analog Bass	Dark Analog Bass
358	Bright Analog Bass	Bt Analog Bass
359	Chorus Analog Bass	Cho Analog Bass
360	Wah Analog Bass	Wah Analog Bass
361	Distortion Guitar & Analog Bass	DtGt & Analog Ba
362	Overdriven Guitar & Analog Bass	OvGt & Analog Ba
363	Hammer Analog Bass	Hammer Analog Ba
364	Dark Hammer Bass	Dark Hammer Ba
365	Bright Attack Bass	Bright Attack Ba
366	Pulse Attack Bass	Pulse Attack Ba
367	Bright Pulse Bass	Bright Pulse Ba
368	Octave Analog Bass	Octave Analog Ba
369	Power Analog Bass	Power Analog Ba
370	Power Pulse Bass	Power Pulse Ba
371	Wah Pulse Bass	Wah Pulse Bass
372	Chorus Pulse Bass	Cho Pulse Bass
Strings		
373	Solo Strings	Solo Strings
374	Slow Strings 1	Slow Strings 1
375	Sweet Violin	Sweet Violin
376	Sweet Cello	Sweet Cello
377	The Strings 1	The Strings 1
378	Orchestra 1	Orchestra 1
379	Slow Strings 2	Slow Strings 2
380	Contrabass 1	Contrabass 1
381	Chamber Music	Chamber Music
382	Slow Strings 3	Slow Strings 3
383	Strings & Brass 1	Strings&Brass 1
384	Strings & Brass 2	Strings&Brass 2
385	Strings & Flute	Strings & Flute
386	Strings & Oboe	Strings & Oboe

387	Arco Strings 1	Arco Strings 1
388	String Ensembles 1	Str Ensembles 1
389	Choir Aahs 1	Choir Aahs 1
390	Voice Oohs	Voice Oohs
391	Synth Voice	Synth Voice
392	Orchestra 2	Orchestra 2
393	Arco Strings 2	Arco Strings 2
394	The Strings 2	The Strings 2
395	Tremolo Strings	Tremolo Strings
396	Pizzicato Strings	Pizzicato Str
397	The Strings 3	The Strings 3
398	Synth Strings 1	Synth Strings 1
399	Synth Strings 2	Synth Strings 2
400	Synth Strings 3	Synth Strings 3
401	Orchestral Harp	Orchestral Harp
402	Violin	Violin
403	Viola	Viola
404	Cello	Cello
405	Contrabass 2	Contrabass 2
406	Choir Aahs 2	Choir Aahs 2
407	Humming	Humming
408	Analog Voice	Analog Voice
409	Orchestra Hit	Orchestra Hit
410	Bass Hit Plus	Bass Hit Plus
411	6th Hit	6th Hit
412	Euro Hit	Euro Hit
413	Slow Sweet Violin	Slow Sweet Vin
414	Dark Sweet Violin	Dark Sweet Vin
415	Bright Sweet Violin	Bright Sweet Vin
416	Slow Violin	Slow Violin
417	Dark Violin	Dark Violin
418	Bright Violin	Bright Violin
419	Chorus Violin	Chorus Violin
420	Sweet Violin 2	Sweet Violin 2
421	Slow Viola	Slow Viola
422	Dark Viola	Dark Viola
423	Bright Viola	Bright Viola
424	Volin & Viola	Volin & Viola
425	Chorus Viola	Chorus Viola
426	Harp & Viola	Harp & Viola
427	Cello & Viola	Cello & Viola
428	Aah & Viola	Aah & Viola
429	Slow Cello	Slow Cello
430	Dark Cello	Dark Cello
431	Bright Cello	Bright Cello
432	Chorus Cello	Chorus Cello
433	Violin & Cello	Violin & Cello
434	Aah & Cello	Aah & Cello
435	Harp & Cello	Harp & Cello
436	Contrabass & Cello	Contrbs & Cello
437	Dark Contrabass	Dark Contrabass
438	Bright Contrabass	Bright Contrbs
439	Chorus Contrabass	Chorus Contrbs
440	Slow Contrabass	Slow Contrabass
441	Violin & Contrabass	Vin & Contrbs
442	Viola & Contrabass	Viola & Contrbs

Voice List

443	Aah & Contrabass	Aah & Contrabass
444	Harp & Contrabass	Harp & Contrbs
445	Dark Tremolo Strings	Dark Trem Str
446	Bright Tremolo Strings	BrT Trem Str
447	Slow Tremolo Strings	Slow Trem Str
448	Cello & Tremolo Strings	Cello & Trem Str
449	Violin & Tremolo Strings	Violin & Trem Str
450	Aah & Tremolo Strings	Aah & Trem Str
451	Harp & Tremolo Strings	Harp & Trem Str
452	Chorus Tremolo Strings	Cho Trem Str
453	Dark Pizzicato Strings	Dark Pizz Str
454	Bright Pizzicato Strings	Bright Pizz Str
455	Bass Hit & Pizzicato Strings	BassH & Pizz Str
456	6th Hit & Pizzicato Strings	6th Hit&Pizz Str
457	Euro Hit & Pizzicato Strings	EuroHit & PizStr
458	Harp & Pizzicato Strings	Harp & PizzStr
459	Arco Strings & Pizzicato Strings	ArcoStr & PizzStr
460	Strings & Pizzicato Strings	St & Pizz Str
461	Dark Harp	Dark Harp
462	Bright Harp	Bright Harp
463	Aah Harp	Aah Harp
464	String Harp	String Harp
465	Chorus Harp	Chorus Harp
466	Humming & Harp	Humming & Harp
467	Euro Hit & Harp	Euro Hit & Harp
468	Synth Voice & Harp	Sy Voice & Harp
Brass & Sax		
469	Trumpet 1	Trumpet 1
470	Trombone 1	Trombone 1
471	Muted Trumpet 1	Muted Trumpet 1
472	French Horn 1	French Horn 1
473	Dark Trumpet Soft	DarkTrump Soft
474	Tuba	Tuba
475	Trumpet 2	Trumpet 2
476	Trombone 2	Trombone 2
477	Muted Trumpet 2	Muted Trumpet 2
478	Bright Trombone1	Bright Trombone1
479	Dark Trombone 1	Dark Trombone 1
480	Dark Trombone 2	Dark Trombone 2
481	Resonant Trombone 1	Reson Trb 1
482	Resonant Trombone 2	Reson Trb 2
483	Brassband 1	Brassband 1
484	French Horn 2	French Horn 2
485	Warm Trumpet	Warm Trumpet
486	Bright Trumpet	Bright Trumpet
487	Chorus Trumpet	Chorus Trumpet
488	Trumpet 1 & Trumpet 2	Trp 1 & Trp 2
489	Trombone & Trumpet	Tb & Trp
490	Tuba & Trumpet	Tuba & Trumpet
491	Resonant Trumpet	Reson Trp
492	French Horn & Trumpet	Fr Horn & Trp
493	Warm Trombone	Warm Trombone
494	Bright Trombone2	Bright Trombone2
495	Chorus Trombone	Chorus Trombone
496	Trombone 1 & Trombone2	Trb1 & Trb2
497	French Horn & Trombone	Fr Horn & Trb

498	Tuba & Trombone	Tuba & Trombone
499	Soprano Sax & Trombone	Sp Sax & Trb
500	Alto Sax & Trombone	Alto Sax & Trb
501	Dark Tuba	Dark Tuba
502	Bright Tuba	Bright Tuba
503	Warm Tuba	Warm Tuba
504	Chorus Tuba	Chorus Tuba
505	Resonant Tuba	Resonant Tuba
506	Slow Tuba	Slow Tuba
507	Soprano Sax & Tuba	Sprno Sax & Tuba
508	Alto Sax & Tuba	Alto Sax & Tuba
509	Dark Muted Trumpet	Dark Muted Trp
510	Bright Muted Trumpet	Bright Muted Trp
511	Warm Muted Trumpet	Warm Muted Trp
512	Chorus Muted Trumpet	Chorus Muted Trp
513	Tuba & Muted Trumpet	Tuba & Muted Trp
514	French Horn & Muted Trumpet	FrHorn & MtTrp
515	Soprano Sax & Muted Trumpet	SprnSax & MtTrp
516	Alto Sax & Muted Trumpet	AltoSax & MtTrp
517	Dark French Horn	Dark French Horn
518	Bright French Horn	Bright Fr Horn
519	Warm French Horn	Warm French Horn
520	Chorus French Horn	Chorus Fr Horn
521	Tuba & French Horn	Tuba & Fr Horn
522	Soprano Sax & French Horn	SprnSax & FrHorn
523	Alto Sax & French Horn	AltoSax & FrHorn
524	Slow French Horn	Slow French Horn
525	Dark Brass Section	Dark Br Section
526	Bright Brass Section	BrT Br Section
527	Warm Brass Section	Warm Br Section
528	Chorus Brass Section	Cho Br Section
529	Resonant Brass Section	Reson Br Section
530	Slow Brass Section	Slow Br Section
531	Funk Brass Section	Funk Br Section
532	Jazz Brass Section	Jazz Br Section
533	Dark Synth Brass	Dark Syn Brass
534	Bright Synth Brass	BrT Syn Brass
535	Warm Synth Brass	Warm Syn Brass
536	Chorus Synth Brass	Cho Syn Brass
537	Resonant Synth Brass	Reson Syn Brass
538	Slow Synth Brass	Slow Syn Brass
539	Rock Synth Brass	Rock Syn Brass
540	Pop Synth Brass	Pop Synth Brass
541	Dark Analog Synth Brass	Dk Ana Syn Br
542	Bright Analog Synth Brass	BrT Ana Syn Br
543	Warm Analog Synth Brass	Warm Ana Syn Br
544	Chorus Analog Synth Brass	Cho Ana Syn Br
545	Resonant Analog Synth Brass	Reso Ana Syn Br
546	Slow Analog Synth Brass	Slow Ana Syn Br
547	Rock Analog Synth Brass	Rock Ana Syn Br
548	Wah Analog Synth Brass	Wah Ana Syn Br
549	Brass Section 1	Brass Section 1
550	Brass Section 2	Brass Section 2
551	Octave Brass Section	Oct Br Section
552	French Horn Live 1	Fr Horn Live 1
553	French Horn Live 2	Fr Horn Live 2

Voice List

554	Brassband 2	Brassband 2
555	Brass Section 3	Brass Section 3
556	Dark Brass 1	Dark Brass 1
557	Synth Brass 1	Synth Brass 1
558	Bright Brass Section 1	Bright Brass 1
559	Sforzato Brass	Sforzato Brass
560	Brassband 3	Brassband 3
561	Club Brass Section	Club Brass
562	Bright Brass Section 2	Bright Brass 2
563	Soft Brass Section 1	Soft Brass 1
564	Synth Brass 2	Synth Brass 2
565	Soft Synth Brass 1	Soft Synth Brass 1
566	Soft Synth Brass 2	Soft Synth Brass 2
567	Jump Brass	Jump Brass
568	Soft Brass Section 2	Soft Brass 2
569	BigBand 1	BigBand 1
570	Solo Brass 1	Solo Brass 1
571	Bright Brass Section 3	Bright Brass 3
572	Synth Brass 3	Synth Brass 3
573	Solo Brass 2	Solo Brass 2
574	Soft Brass Section 3	Soft Brass 3
575	BigBand 2	BigBand 2
576	Synth Brass 4	Synth Brass 4
577	Brass Hit	Brass Hit
578	Analog Synth Brass 1	Ana Syn Br 1
579	Solo Brass 3	Solo Brass 3
580	Solo Brass 4	Solo Brass 4
581	Analog Synth Brass 2	Ana Syn Br 2
582	Funky Synth Brass 1	Funky Syn Br 1
583	Echo Brass	Echo Brass
584	Analog Synth Brass 3	Ana Syn Br 3
585	Soft Synth Brass	Soft Syn Br
586	Funky Synth Brass 2	Funky Syn Br 2
587	Tenor Sax 1	Tenor Sax 1
588	Alto Sax 1	Alto Sax 1
589	Soprano Sax 1	Soprano Sax 1
590	Baritone Sax 1	Baritone Sax 1
591	Sax Band 1	Sax Band 1
592	Sax Band 2	Sax Band 2
593	Sax & Clarinet	Sax & Clarinet
594	Sax Live 1	Sax Live 1
595	Sax Live 2	Sax Live 2
596	Soprano Sax 2	Soprano Sax 2
597	Tenor Sax 2	Tenor Sax 2
598	Alto Sax 2	Alto Sax 2
599	Baritone Sax 2	Baritone Sax 2
600	Slow Tenor Sax	Slow Tenor Sax
601	Soft Sax Band	Soft Sax Band
602	Super Sax Band	Super Sax Band
Flute & Wood Wind		
603	Flute 1	Flute 1
604	Clarinet 1	Clarinet 1
605	Pan Flute 1	Pan Flute 1
606	Oboe 1	Oboe 1
607	Flute & Sax	Flute & Sax
608	English Horn	English Horn

609	Bassoon	Bassoon
610	Sweet Flute	Sweet Flute
611	Piccolo	Piccolo
612	Clarinet & Sax	Clarinet & Sax
613	Sweet Pan Flute	Sweet Pan Flute
614	Shakuhachi	Shakuhachi
615	Clarinet 2	Clarinet 2
616	Flute 2	Flute 2
617	Pan Flute 2	Pan Flute 2
618	Oboe 2	Oboe 2
619	Whistle	Whistle
620	Recorder	Recorder
621	Blown Bottle	Blown Bottle
622	Ocarina	Ocarina
623	Dark Piccolo	Dark Piccolo
624	Bright Piccolo	Bright Piccolo
625	Chorus Piccolo	Chorus Piccolo
626	Warm Piccolo	Warm Piccolo
627	Slow Piccolo	Slow Piccolo
628	Whistle & Piccolo	Whistle & Picco
629	Dark Flute	Dark Flute
630	Bright Flute	Bright Flute
631	Chorus Flute	Chorus Flute
632	Warm Flute	Warm Flute
633	Slow Flute	Slow Flute
634	Whistle & Flute	Whistle & Flute
635	Piccolo & Recorder	Picco & Record
636	Pan Flute & Recorder	Pan Flu & Record
637	Shakuhachi & Recorder	Shaku & Record
638	Clarinet & Recorder	Clarine & Record
639	Flute & Recorder	Flute & Record
640	Blown Bottle & Recorder	BlowBot & Record
641	Dark Pan Flute	Dark Pan Flute
642	Bright Pan Flute	Bright Pan Flute
643	Warm Pan Flute	Warm Pan Flute
644	Chorus Pan Flute	Chorus Pan Flute
645	Whistle & Pan Flute	Whistle & PanFlu
646	Slow Pan Flute	Slow Pan Flute
647	Dark Blown Bottle	Dk Blown Bottle
648	Bright Blown Bottle	Brt Blown Bottle
649	Chorus Blown Bottle	Cho Blown Bottle
650	Warm Blown Bottle	Warm Blow Bottle
651	Slow Blown Bottle	Slow Blow Bottle
652	Oboe & Blown Bottle	Obo & BlowBottle
653	Dark Shakuhachi	Dark Shakuhachi
654	Bright Shakuhachi	Bright Shaku
655	Chorus Shakuhachi	Chorus Shaku
656	Warm Shakuhachi	Warm Shaku
657	Slow Shakuhachi	Slow Shakuhachi
658	Piccolo & Shakuhachi	Piccolo & Shaku
659	Bright Whistle	Bright Whistle
660	Blown Bottle & Whistle	BlowBot & Whist
661	Shakuhachi & Whistle	Shaku & Whistle
662	Oboe & Whistle	Oboe & Whistle
663	Piccolo & Ocarina	Picco & Ocarina
664	Pan Flute & Ocarina	Pan Flu & Ocar

Voice List

665	Oboe & Ocarina	Oboe & Ocarina
666	Blown Bottle & Ocarina	BlowBott & Ocari
667	Shakuhachi & Ocarina	Shaku & Ocari
Lead & Pad		
668	Sine Solo 1	Sine Solo 1
669	Sine Solo 2	Sine Solo 2
670	Corrie 1	Corrie 1
671	Wire Lead 1	Wire Lead 1
672	Wire Lead 2	Wire Lead 2
673	Big Lead 1	Big Lead 1
674	Wavy Sawtooth 1	Wavy Sawtooth 1
675	Bauble Lead	Bauble Lead
676	Super Analog	Super Analog
677	Big Lead 2	Big Lead 2
678	Wire Lead 3	Wire Lead 3
679	Massiness 1	Massiness 1
680	Massiness 2	Massiness 2
681	2Oscillators Lead 1	2Oscillator Ld 1
682	2Oscillators Lead 2	2Oscillator Ld 2
683	Square	Square
684	Sawtooth	Sawtooth
685	Soft Big Lead 1	Soft Big Lead 1
686	Thick Saw 1	Thick Saw 1
687	Thick Saw 2	Thick Saw 2
688	Soft Sine 1	Soft Sine 1
689	Wah Lead 1	Wah Lead 1
690	Wah Lead 2	Wah Lead 2
691	Soft Wah Lead	Soft Wah Lead
692	Corrie 2	Corrie 2
693	Funky Lead	Funky Lead
694	Delayed Lead 1	Delayed Lead 1
695	Chiffer Lead	Chiffer Lead
696	Octave Lead	Octave Lead
697	Echo Drops 1	Echo Drops 1
698	SynCalliope Soft 1	SynCalliop Soft 1
699	Delayed Lead 2	Delayed Lead 2
700	Massiness 3	Massiness 3
701	EchoBell 1	EchoBell 1
702	SynCalliope Soft 2	SynCalliop Soft 2
703	Soft Sine 2	Soft Sine 2
704	Jazz Lead	Jazz Lead
705	Soft Big Lead 2	Soft Big Lead 2
706	EchoBell 2	EchoBell 2
707	Echo Crystal 1	Echo Crystal 1
708	EchoBell 3	EchoBell 3
709	Echo Crystal 2	Echo Crystal 2
710	Rising	Rising
711	Charang 1	Charang 1
712	Wavy Sawtooth 2	Wavy Sawtooth 2
713	Thick Square	Thick Square
714	Wah Sine Solo 1	Wah Sine Solo 1
715	TremoloMatrix	TremoloMatrix
716	DarkWire	DarkWire
717	ChorusHipLead 1	ChorusHip Lead 1
718	ChorusHipLead 2	ChorusHip Lead 2
719	Wire Lead 3	Wire Lead 3

720	Bright Hop Lead	Bright Hop Lead
721	Wah Hop Lead	Wah Hop Lead
722	TremoloBauble Lead	TreBauble Lead
723	ChorusSoftMini	ChorusSoftMini
724	Soft Trance Lead	SoftTraLead
725	Chiffe Fire Wire	ChiFireWire
726	Soft Analogon	Soft Analogon
727	BrightAnalogon	BrightAnalogon
728	Tekkline Analogon	Tekkline Ana
729	Corrie Analogon	Corrie Analogon
730	CorrieCalliope 1	CorrieCalliope 1
731	WahCalliope	WahCalliope
732	BrightCalliope	BrightCalliope
733	AnalogonCalliope1	AlgnCalliope1
734	AnalogonCalliope2	AlgnCalliope2
735	AnalogonCalliope3	AlgnCalliope3
736	CorrieCalliope 2	CorrieCalliope 2
737	Wah Calliope	Wah Calliope
738	Soft Chiffer Lead	Soft Chiffer Ld
739	Bright Chiffer Lead	Brt Chiffer Ld
740	Tremolo Chiffer Lead	Trem Chiffer Ld
741	TrumpSaw Chiffer Lead	TrpSaw Chiff Ld
742	Analogon Chiffer Lead	Ana Chiffer Ld
743	Tekkline Chiffer Lead	Tekklin Chiff Ld
744	Corrie Chiffer Lead	Corrie Chiff Ld
745	Stardust Warp	Stardust Warp
746	Soft Funky Lead 1	Soft Funky Ld 1
747	Soft Funky Lead 2	Soft Funky Ld 2
748	Wire Funky Lead	Wire Funky Lead
749	Soft Octave Lead	Soft Octave Lead
750	Bauble Octave Lead	Bauble Octave Ld
751	Tremolo Octave Lead	Tremolo Oct Ld
752	Calliope Octave Lead	Calliope Oct Ld
753	Big Octave Lead	Big Octave Lead
754	Bright Voice Lead	Bright Voice Ld
755	Soft Voice Lead	Soft Voice Lead
756	Delayed Voice Lead 1	Dely Voice Lead1
757	Delayed Voice Lead 2	Dely Voice Lead2
758	Funky Voice Lead1	Funky Voice Ld 1
759	Funky Voice Lead2	Funky Voice Ld 2
760	Jazz Voice Lead	Jazz Voice Lead
761	Big Voice Lead	Big Voice Lead
762	Soft Rising 1	Soft Rising1
763	Soft Rising 2	Soft Rising2
764	Bright Rising 1	Bright Rising 1
765	Bright Rising 2	Bright Rising 2
766	Wah Rising 1	Wah Rising 1
767	Wah Rising 2	Wah Rising 2
768	Wah Rising 3	Wah Rising 3
769	Wah Rising 4	Wah Rising 4
770	Soft Bass Lead 1	Soft Bass Lead 1
771	Soft Bass Lead 2	Soft Bass Lead 2
772	Voice Bass Lead	Voice Bass Lead
773	Bright Bass Lead 1	Bright Bass Ld 1
774	Calliope Bass Lead	Calliope Bass Ld
775	Analogon Bass Lead	Analogon Bass Ld

Voice List

776	Bright Bass Lead 2	Bright Bass Ld 2
777	Wah Bass Lead	Wah Bass Ld
778	Bright Delayed Lead	Bright Delay Ld
779	Soft Cry Eyes 1	Soft Cry Eyes 1
780	Soft Cry Eyes 2	Soft Cry Eyes 2
781	Bright Cry Eyes	Bright Cry Eyes
782	Square Cry Eyes	Square Cry Eyes
783	Analogon Cry Eyes	Ana Cry Eyes
784	Vox Cry Eyes	Vox Cry Eyes
785	Space Voice Cry Eyes	Spa Vc Cry Eyes
786	Soft Stardust 1	Soft Stardust 1
787	Soft Stardust 2	Soft Stardust 2
788	Bright Stardust 1	Brt Stardust 1
789	Bright Stardust 2	Brt Stardust 2
790	Wah Stardust 1	Wah Stardust 1
791	Warm Stardust	Warm Stardust
792	Wah Stardust 2	Wah Stardust 2
793	Square Stardust	Square Stardust
794	Space Voice 1	Space Voice 1
795	Vox Pad 1	Vox Pad 1
796	Vox Pad 2	Vox Pad 2
797	Vox Pad 3	Vox Pad 3
798	New Year Pad 1	New Year Pad 1
799	New Year Pad 2	New Year Pad 2
800	Soft Vox	Soft Vox
801	Space Voice 2	Space Voice 2
802	New Year Pad 3	New Year Pad 3
803	New Year Pad 4	New Year Pad 4
804	New Age Pad 1	New Age Pad 1
805	New Age Pad 2	New Age Pad 2
806	Soft Space Voice 1	Soft Space Vc 1
807	Bright Space Voice 1	Brt Space Vc 1
808	Bright Vox	Bright Vox
809	Bright Space Voice 2	Brt Space Vc 2
810	Soft Space Voice 2	Soft Space Vc 2
811	Choir&Organ	Choir&Organ
812	New Age Pad 3	New Age Pad 3
813	New Age Pad 4	New Age Pad 4
814	Warm Pad 1	Warm Pad 1
815	PWM Pad	PWM Pad
816	Warmly Pad 1	Warmly Pad 1
817	Warm Pad 2	Warm Pad 2
818	Sine Pad 1	Sine Pad 1
819	Warm Pad 3	Warm Pad 3
820	Sweep Pad 1	Sweep Pad 1
821	Poly Synth 1	Poly Synth 1
822	Dipolar Pad	Dipolar Pad
823	Poly Synth 2	Poly Synth 2
824	Poly Synth 3	Poly Synth 3
825	New Age Pad 3	New Age Pad 3
826	Horn Pad	Horn Pad
827	Metallic Pad 1	Metallic Pad 1
828	Metallic Pad 2	Metallic Pad 2
829	Pan Pad 1	Pan Pad 1
830	Congregate	Congregate
831	Pan Pad 2	Pan Pad 2

832	Pan Pad 3	Pan Pad 3
833	New Age Pad 4	New Age Pad 4
834	Itopia Pad 1	Itopia Pad 1
835	Itopia Pad 2	Itopia Pad 2
836	Metallic Pad 3	Metallic Pad 3
837	Metallic&Itopia	Metallic&Itopia
838	Sine Pad 2	Sine Pad 2
839	Sweep Pad 2	Sweep Pad 2
840	Analog Pad 1	Analog Pad 1
841	Analog Pad 2	Analog Pad 2
842	Bowed Pad 1	Bowed Pad 1
843	New Age&Bowed Pad 1	NewAge&Bow Pd 1
844	New Age&Bowed Pad 2	NewAge&Bow Pd 2
845	Halo Pad 1	Halo Pad 1
846	Halo&Bowed Pad	Halo&Bowed Pad
847	Poly Pad	Poly Pad
848	Slow Warm Pad	Slow Warm Pad
849	Bright New Age Pad	Brt New Age Pd
850	Warmly New Age Pad1	Warm New Age Pd1
851	Metallic New Age Pad	Metal New Age Pd
852	New Age Tune Pad	New Age Tune Pad
853	Choir New Age Pad	Choir New Age Pd
854	Warmly New Age Pad2	Warm New Age Pd2
855	Dipolar New Age Pad	Dipol New Age Pd
856	Wah New Age Pad	Wah New Age Pad
857	Warmly Pad	Warmly Pad
858	Warmly Pad 2	Warmly Pad 2
859	BigBand Pad	BigBand Pad
860	Organ Pad	Organ Pad
861	12-String Guitar Pad	12-String Gt Pd
862	Modern Pad	Modern Pad
863	Bright Pad 1	Bright Pad 1
864	Bright Pad 2	Bright Pad 2
865	Soft PolySy Pad	Soft PolySy Pad
866	Bright PolySy Pad	Bright PolySy Pd
867	Wah PolySy Pad	Wah PolySy Pad
868	Vox PolySy Pad	Vox PolySy Pad
869	Calliope PolySy Pad	Callio PolySy Pd
870	Harmonica PolySy Pad	Harm PolySy Pd
871	Analogon PolySy Pad	Ana PolySy Pd
872	Square PolySy Pad	Square PolySy Pd
873	Wah Space Voice 1	Wah Space Vc 1
874	Wah Space Voice 2	Wah Space Vc 2
875	Soft Itopia Pad 1	Soft Itopia Pd 1
876	Square Itopia Pad	Squar Itopia Pd
877	Bright Itopia Pad 1	Brt Itopia Pd 1
878	Analogon Itopia Pad	Ana Itopia Pd
879	Bright Itopia Pad 2	Brt Itopia Pd 2
880	Soft Itopia Pad 2	Soft Itopia Pd 2
881	Bright Bowed Pad 1	Brt Bowed Pd 1
882	Soft Bowed Pad 1	Soft Bowed Pad 1
883	Wah Bowed Pad	Wah Bowed Pad
884	Corrie Bowed Pad	Corrie Bowed Pd
885	Congregate Bowed Pad	Cong Bowed Pd
886	Calliope Bowed Pad	Calliop Bowed Pd
887	Bright Bowed Pad 2	Brt Bowed Pd 2

Voice List

888	Soft Bowed Pad 2	Soft Bowed Pad 2
889	Bright Metal Pad 1	Brnt Metal Pd 1
890	Soft Metal Pad	Soft Metal Pad
891	Wah Metal Pad	Wah Metal Pad
892	Space Voice Metal Pad	Space Vc Met Pd
893	Modern Metal Pad	Modern Metal Pad
894	Congregate Metal Pad	Cong Metal Pd
895	Calliope Metal Pad	Calliop Metal Pd
896	Bright Metal Pad 2	Brnt Metal Pd 2
897	Bright Halo Pad	Bright Halo Pad
898	Soft Halo Pad	Soft Halo Pad
899	Wah Halo Pad	Wah Halo Pad
900	PWM Halo Pad	PWM Halo Pad
901	Bowed Halo Pad	Bowed Halo Pad
902	Congregate Halo Pad	Cong Halo Pd
903	Metal Halo Pad	Metal Halo Pad
904	Corrie Halo Pad	Corrie Halo Pad
905	Soft Dipolar Pad	Soft Dipolar Pad
906	Wah Dipolar Pad	Wah Dipolar Pad
907	Vox Dipolar Pad	Vox Dipolar Pad
908	Metallic Dipolar Pad	Metal Dipolar Pd
909	Warmly Dipolar Pad	Warm Dipolar Pd
910	Congregate Dipolar Pad	Cong Dipolar Pd
911	Calliope Dipolar Pad	Calli Dipolar Pd
912	Corrie Dipolar Pad	Corie Dipolar Pd
Synth FX & Sound Effects		
913	Guitar Fret Noise	GtFret Noise
914	Guitar Cutting Noise	GtCutting Noise
915	Acoustic Bass String Slap	Bass String Slap
916	Breath Noise	Breath Noise
917	Flute Key Click	Flute Key Click
918	Seashore	Seashore
919	Rain	Rain
920	Thunder	Thunder
921	Wind 1	Wind 1
922	Stream	Stream
923	Bubble	Bubble
924	Bird Tweet 1	Bird Tweet 1
925	Dog	Dog
926	Horse Gallop	Horse Gallop
927	Bird Tweet 2	Bird Tweet 2
928	Telephone Ring 1	Telephone Ring 1
929	Telephone Ring 2	Telephone Ring 2
930	Door Creaking	Door Creaking
931	Door	Door
932	Scratch	Scratch
933	Wind Chime	Wind Chime
934	Helicopter	Helicopter
935	Car Engine	Car Engine
936	Car Stop	Car Stop
937	Car Pass	Car Pass
938	Car Crash	Car Crash
939	Siren	Siren
940	Train	Train
941	Jetplane	Jetplane

942	Starship	Starship
943	Burst Noise	Burst Noise
944	Applause	Applause
945	Laughing	Laughing
946	Screaming	Screaming
947	Punch	Punch
948	Heart Beat	Heart Beat
949	Footsteps	Footsteps
950	Gunshot	Gunshot
951	Machine Gun	Machine Gun
952	Lasergun	Lasergun
953	Explosion	Explosion
Ethnic & Combined		
954	Fiddle	Fiddle
955	Sitar	Sitar
956	Hackbrett	Hackbrett
957	Banjo	Banjo
958	Shamisen	Shamisen
959	Koto	Koto
960	Kalimba	Kalimba
961	Shanai	Shanai
962	Bag Pipe	Bag Pipe
963	Stereo Piano & Strings	Piano&Strings
964	Stereo Piano & Calliope	Piano&Calliope
965	Stereo Piano & Sweep	Piano&Sweep
966	Honky Tonk Piano & Fifths	Honk&Fifths
967	Honky Tonk Piano & Sweep	Honk&Sweep
968	FM Electric Piano	FM E.Piano
969	Digital Piano	Digital Piano
970	E.Piano & Pad	E.Piano&Pad
971	E.Piano & Sweep	E.Piano&Sweep
Perc/Drum		
972	Vibraphone (wide) 1	Vibraphone/Wide 1
973	Rigid Vibraphone	Rigid Vibraphone
974	Vibraphone 1	Vibraphone 1
975	Steel Drums 1	Steel Drums 1
976	Celesta 1	Celesta 1
977	Vibraphone 2	Vibraphone 2
978	Vibraphone 3	Vibraphone 3
979	Music Box & Flute	Music Box&Flute
980	Marimba 1	Marimba 1
981	Xylophone 1	Xylophone 1
982	Steel Drums 2	Steel Drums 2
983	Celesta 2	Celesta 2
984	Glockenspiel 1	Glockenspiel 1
985	Music Box 1	Music Box 1
986	Tubular Bells 1	Tubular Bells 1
987	Church Bell 1	Church Bell 1
988	Carillon 1	Carillon 1
989	Dulcimer 1	Dulcimer 1
990	Timpani 1	Timpani 1
991	Taiko Drum	Taiko Drum
992	Concert Bass Drum	Concert Ba Drum
993	Melodic Tom 1	Melodic Tom 1
994	Melodic Tom 2	Melodic Tom 2
995	Synth Drum	Synth Drum

Voice List

996	Rhythm Box Tom	Rhythm Box Tom
997	Electric Drum	Electric Drum
998	Reverse Cymbal	Reverse Cymbal
999	Standard Set 1	Standard Set 1
1000	Standard Set 2	Standard Set 2
1001	Jazz Set	Jazz Set
1002	Brush Set	Brush Set
1003	Dance Set 1	Dance Set 1
1004	Room Set	Room Set
1005	Power Set	Power Set
1006	Electronic Set	Electronic Set
1007	Analog Set	Analog Set
1008	Dance Set 2	Dance Set 2
1009	Orchestra Set	Orchestra Set
1010	SFX Set	SFX Set
1011	Studio Set	Studio Set
GM		
1012	Acoustic Grand Piano	Grand Piano
1013	Acoustic Grand Piano (wide)	Grand Piano/Wide
1014	Acoustic Grand Piano (dark)	Grand Piano/Dark
1015	Bright Acoustic Piano	Bright Piano
1016	Bright Acoustic Piano (wide)	Bright Piano/Wide
1017	Electric Grand Piano	Electric Grand
1018	Electric Grand Piano (wide)	Elec.Grand/Wide
1019	Honky Tonk Piano	Honky Tonk
1020	Honky Tonk Piano (wide)	Honky Tonk/Wide
1021	Electric Piano 1	E.Piano 1
1022	Electric Piano 2	E.Piano 2
1023	Detuned Electric Piano 1	Detuned EP 1
1024	Electric Piano 1 (velocity mix)	Velocity EP 1
1025	60's Electric Piano	60's EP
1026	Detuned Electric Piano 2	Detuned EP 2
1027	Electric Piano 2 (velocity mix)	Velocity EP 2
1028	EP Legend	EP Legend
1029	Phase EP 1	Phase EP 1
1030	Harpsichord	Harpsichord
1031	Harpsichord (octave mix)	Harpsichord/Octave
1032	Harpsichord (wide)	Harpsichord/Wide
1033	Harpsichord (with key off)	Harpsichord/KeyOff
1034	Clavi	Clavi
1035	Pulse Clavi	Pulse Clavi
1036	Celesta	Celesta
1037	Glockenspiel I	Glockenspiel I
1038	Music Box	Music Box
1039	Vibraphone	Vibraphone
1040	Vibraphone (wide)	Vibraphone/Wide
1041	Marimba	Marimba
1042	Marimba (wide)	Marimba/Wide
1043	Xylophone	Xylophone
1044	Tubular Bells	Tubular Bells
1045	Church Bell	Church Bell
1046	Carillon	Carillon
1047	Dulcimer	Dulcimer
1048	Drawbar Organ	Drawbar Organ
1049	Detuned Drawbar Organ	Detuned DrawOrg
1050	Italian 60's Organ	60's Organ
1051	Drawbar Organ 2	Drawbar Organ 2

1052	Percussive Organ	Percussive Organ
1053	Detuned Percussive Organ	Detuned PercOrgan
1054	Percussive Organ 2	Percussive Organ 2
1055	Rock Organ	Rock Organ
1056	Church Organ	Church Organ
1057	Church Organ (octave mix)	ChurchOrg/Octave
1058	Detuned Church Organ	Detune ChurchOrg
1059	Reed Organ	Reed Organ
1060	Puff Organ	Puff Organ
1061	Accordion	Accordion
1062	Accordion 2	Accordion 2
1063	Harmonica	Harmonica
1064	Tango Accordion	Tango Accordion
1065	Acoustic Guitar (nylon)	Nylon Guitar
1066	Ukulele	Ukulele
1067	Acoustic Guitar (nylon + key off)	NylonGtr/KeyOff
1068	Acoustic Guitar (nylon 2)	Nylon Guitar 2
1069	Acoustic Guitar (steel)	Steel Guitar
1070	12-String Guitar	12String Guitar
1071	Mandolin	Mandolin
1072	Steel Guitar with Body Sound	SteelGtr/BodySd
1073	Electric Guitar (jazz)	Jazz Guitar
1074	Electric Guitar (pedal steel)	Pedal Guitar
1075	Electric Guitar (clean)	Clean Guitar
1076	Electric Guitar (detuned clean)	Detuned CleanGtr
1077	Mid Tone Guitar	Mid Tone Guitar
1078	Electric Guitar (muted)	Muted Guitar
1079	Electric Guitar (funky cutting)	Funk Guitar
1080	Electric Guitar (muted velo-sw)	Velocity MutedGtr
1081	Jazz Man	Jazz Man
1082	Overdriven Guitar	OverdrivenGtr
1083	Guitar Pinch	Guitar Pinch
1084	Distortion Guitar	DistortionGtr 1
1085	Distortion Guitar (with feedback)	Feedback Guitar
1086	Distorted Rhythm Guitar	Rhythm DistGtr
1087	Guitar Harmonics	Guitar Harmonics
1088	Guitar Feedback	Feedback Guitar 3
1089	Acoustic Bass	Acoustic Bass
1090	Electric Bass (finger)	Finger Bass
1091	Finger Slap Bass	Finger Slap Bass
1092	Electric Bass (pick)	Pick Bass
1093	Fretless Bass	Fretless Bass
1094	Slap Bass 1	Slap Bass 1
1095	Slap Bass 2	Slap Bass 2
1096	Synth Bass 1	Synth Bass 1
1097	Synth Bass 2	Synth Bass 2
1098	Synth Bass (warm)	Warm Synth Bass
1099	Synth Bass 3 (resonance)	Resonance SynBass
1100	Clavi Bass	Clavi Bass
1101	Hammer	Hammer
1102	Synth Bass 4 (attack)	Attack Bass
1103	Synth Bass (rubber)	Rubber Bass
1104	Attack Pulse	Attack Pulse
1105	Violin	Violin
1106	Violin (slow attack)	Slow Violin
1107	Viola	Viola

Voice List

1108	Cello	Cello
1109	Contrabass	Contrabass
1110	Tremolo Strings	Tremolo Strings
1111	Pizzicato Strings	Pizzicato Str
1112	Orchestral Harp	Orchestral Harp
1113	Yang Chin	Yang Chin
1114	Timpani 1	Timpani 1
1115	String Ensembles 1	String Ensembles 1
1116	String Ensembles 2	String Ensembles 2
1117	Strings & Brass	Strings&Brass
1118	60's Strings	60's Strings
1119	Synth Strings 1	Synth Strings 1
1120	Synth Strings 2	Synth Strings 2
1121	Synth Strings 3	Synth Strings 3
1122	Choir Aahs	Choir Aahs
1123	Choir Aahs 2	Choir Aahs 2
1124	Voice Oohs	Voice Oohs
1125	Humming	Humming
1126	Analog Voice	Analog Voice
1127	Synth Voice	Synth Voice
1128	Orchestra Hit	Orchestra Hit
1129	Bass Hit Plus	Bass Hit Plus
1130	6th Hit	6th Hit
1131	Euro Hit	Euro Hit
1132	Trumpet	Trumpet
1133	Dark Trumpet Soft	DarkTrump Soft
1134	Trombone	Trombone
1135	Trombone 2	Trombone 2
1136	Bright Trombone	Bright Trombone
1137	Tuba	Tuba
1138	Muted Trumpet	Muted Trumpet
1139	Muted Trumpet 2	Muted Trumpet 2
1140	French Horn	French Horn
1141	French Horn 2 (warm)	French Horn 2
1142	Brass Section	Brass Section
1143	Brass Section 2 (octave mix)	Brass Section 2
1144	Synth Brass 1	Synth Brass 1
1145	Synth Brass 2	Synth Brass 2
1146	Synth Brass 3	Synth Brass 3
1147	Synth Brass 4	Synth Brass 4
1148	Analog Synth Brass 1	Analog SynBrass 1
1149	Analog Synth Brass 2	Analog SynBrass 2
1150	Jump Brass	Jump Brass
1151	Soprano Sax	Soprano Sax
1152	Alto Sax	Alto Sax
1153	Tenor Sax	Tenor Sax
1154	Baritone Sax	Baritone Sax
1155	Oboe	Oboe
1156	English Horn	English Horn
1157	Bassoon	Bassoon
1158	Clarinet	Clarinet
1159	Piccolo	Piccolo
1160	Flute	Flute
1161	Recorder	Recorder
1162	Pan Flute	Pan Flute

1163	Blown Bottle	Blown Bottle
1164	Shakuhachi	Shakuhachi
1165	Whistle	Whistle
1166	Ocarina	Ocarina
1167	FX 1 (rain)	FX 1 Rain
1168	FX 2 (soundtrack)	FX 2 SoundTrack
1169	FX 3 (crystal)	FX 3 Crystal
1170	FX 3a (synth mallet)	Synth Mallet
1171	FX 4 (atmosphere)	FX 4 Atmosphere
1172	FX 5 (brightness)	FX 5 Brightness
1173	FX 6 (goblins)	FX 6 Goblins
1174	FX 7 (echoes)	FX 7 Echoes
1175	FX 7a (echo bell)	Echo bell
1176	FX 7b (echo pan)	Echo pan
1177	FX 8 (sci-fi)	FX 8 Sci-Fi
1178	Sitar	Sitar
1179	Sitar 2 (bend)	Sitar 2/Bend
1180	Banjo	Banjo
1181	Shamisen	Shamisen
1182	Koto	Koto
1183	Taisho Koto	Taisho Koto
1184	Kalimba	Kalimba
1185	Bag Pipe	Bag Pipe
1186	Fiddle	Fiddle
1187	Shanai	Shanai
1188	Tinkle Bell	Tinkle Bell
1189	Agogo	Agogo
1190	Steel Drums	Steel Drums
1191	Woodblock	Woodblock
1192	Castanets	Castanets
1193	Taiko Drum	Taiko Drum
1194	ConcertBass Drum	ConBass Drum
1195	Melodic Tom	Melodic Tom
1196	Melodic Tom 2 (power)	Power Melodic Tom
1197	Synth Drum	Synth Drum
1198	Rhythm Box Tom	Rhythm Box Tom
1199	Electric Drum	Electric Drum
1200	Reverse Cymbal	Reverse Cymbal

Style List

No.	Style Name
8BEAT & 16BEAT	
1	8Beat Pop 1
2	Pop Rock 1
3	8Beat Rock
4	8Beat Ballad
5	Pop Jazz
6	8Beat 1
7	8Beat Pop 2
8	Pop Funk 1
9	Rhythm&Beat 1
10	8Beat Disco 1
11	Guitar Pop 1
12	Guitar Pop 2
13	8Beat 2
14	Sweet Beat
15	8Beat Dance
16	8Beat Disco 2
17	Pop Funk 2
18	8Beat 3
19	60's 8Beat
20	Rhythm&Beat 2
21	16Beat 1
22	16Beat Funk 1
23	16Beat Ballad 1
24	16Beat R&B
25	16Beat Pop 1
26	16Beat Funk 2
27	16Beat Dance
28	16Beat Pop 2
29	16Beat 2
30	16Beat Pop 3
31	16Beat Pop 4
32	Modern 16Beat
33	16Beat Hot
34	16Beat Modern
35	16Beat Funk 3
36	16Beat 3
37	Cool Beat
38	16Beat Ballad 2
39	16Beat 4
40	Pop Shuffle
ROCK	
41	Blues Rock
42	Hard Rock
43	Rock
44	New Wave
45	80's metal
46	Ska
47	Pop Rock 2
48	Pop Rock 3
49	Standard Rock
50	Slow Rock
51	70's Rock&Roll
52	Folk Rock
53	Soft Rock

54	Old Rock
55	Easy Rock
56	New Shuffle
57	Rock Hip Hop
58	Rock&Roll 1
59	Rock Shuffle
60	Rock&Roll 2
POP & BALLAD	
61	Sweet Ballad
62	Piano Ballad
63	BriPop 1
64	6-8Ballad
65	Unplugged
66	Pop Rock 4
67	Pop Dance 1
68	Pop Fusion
69	Analog Night 1
70	6/8 Pop
71	Brit. Pop 1
72	Brit. Pop 2
73	Pop Hit
74	Fusion Shuffle
75	Analog Night 2
76	Guitar Pop 3
77	Pop Beat
78	Soft Beat
79	60's Pop
80	Sting Latin
81	R&B Ballad 1
82	Guitar Ballad
83	Ballad Rock
84	Piano Pop 1
85	Soft Ballad
86	Natural Ballad
87	Love Ballad
88	Easy Ballad
89	Miami Folk
90	Slow Ballad
91	Folk Ballad
92	Pop Ballad 1
93	Pop Ballad 2
94	EP Ballad
95	New R&B Ballad
BALLROOM	
96	Tango 1
97	Spain Matador
98	Twist 1
99	Twist 2
100	Big Band Fox
101	Tango 2
102	Tango 3
103	Slow Fox
104	Slow Waltz 1
105	Swing Fox
106	Salsa 1
107	Pop Cha Cha

Style List

108	Cha Cha 1
109	Cha Cha 2
110	Beguine 1
111	Beguine 2
112	Rumba 1
113	Samba 1
114	Samba 2
115	Jive
116	Fox Trot
DANCE	
117	Techno 1
118	Hip Hop 1
119	House 1
120	House 2
121	Pop Dance 2
122	Down Beat
123	Progressive House
124	Dubstep
125	Techno 2
126	Progressive
127	Rap 1
128	Rap 2
129	Disco
130	Soft Disco
131	Disco Party
132	70's Disco
133	70's Disco Funk
134	Club Dance
135	Euro Dance
136	Hip Hop 2
137	Garage
SOUL & FUNK	
138	Pop funk
139	New R&B
140	Pop R&B
141	Neo-Soul
142	Funk 1
143	Classic Funk
144	Jay R&B
145	Gospel Swing
146	Gospel
147	Funk 2
148	Electric Funk
149	Groove Funk
150	Rubber Funk
151	Cool Funky
152	Jazz Funk
153	Groove
154	Soul
155	Hip Hop Soul
156	Hip Hop Beat
157	R&B
158	Soul Beat
159	R&B Ballad 2
160	British Soul Pop
SWING & JAZZ	
161	Modern Big Band

162	Gospel Swing
163	Piano Jazz
164	Smooth Jazz
165	Smooth Operator
166	Latin Jazz 1
167	Big Band
168	Dixieland 1
169	Guitar Swing 1
170	Broadway Big Band
171	Swing
172	Latin Jazz 2
173	Fusion
174	Acid Jazz
175	Cool Jazz Ballad
176	Swing Shuffle
177	Big Band Medium
178	Dixieland 2
179	Acoustic Jazz
180	Guitar Swing 2
181	Ragtime
182	Modern Jazz Ballad
183	Swing Ballad
184	Orchestra Swing
COUNTRY	
185	Ballad Country 1
186	70's Country Rock
187	Ballad Country 2
188	Modern Country
189	Dixie Chicks
190	Country Pop 1
191	Bluegrass 1
192	Bluegrass 2
193	8Beat Country
194	Modern Country
195	Country Pop 2
196	Country Pop 3
197	Bluegrass 3
198	2/4 Country
199	Country Quick Steps
200	Country Folk
201	Country Shuffle
LATIN & LATIN DANCE	
202	Samba 3
203	Bossa Nova
204	Latin
205	New Reggae
206	Reggae Dance
207	Paso Doble
208	Lite Bossa
209	Latin Rock
210	Beguine 3
211	Slow Bolero
212	Disco Samba
213	Mambo
214	Meneito
215	Rumba 2
216	Rumba 3

217	Tikitikita
218	Lambada
219	Pop Cha Cha 1
220	Pop Cha Cha 2
221	Salsa 2
WALTZ & TRADITIONAL	
222	Waltz
223	Old Waltz
224	English Waltz
225	German Waltz
226	Italian Mazurka
227	Mexico Waltz
228	Vienna Waltz
229	Slow Waltz 2
230	Jazz Waltz
231	Polka
232	6/8 March
233	German Polka
234	Party Polka
235	Army March
236	March
237	US March
238	Musette
239	French Musette
240	Mazurka
WORLD	
241	Enka Ballad
242	Laendler
243	Hawaiian
244	Sirtake
245	Dangdut
246	6/8 Flipper
247	New Age
248	Tarantella
249	Scottish
250	Norteno
PIANIST	
251	Pianist 1
252	Pianist 2
253	Pianist 3
254	Jazz 1
255	Jazz 2
256	Jazz Pub
257	Piano Rock
258	Pop Bossa
259	March 1
260	March 2
261	Piano Beat
262	Piano Bar
263	Blues
264	Pop Waltz
265	Slow Waltz
266	Ballad 1
267	Ballad 2
268	6/8 Ballad
269	Pop 1
270	Pop 2

Song List

No.	English Name	LCD Name
FOLK & COUNTRY		
1	Red River Valley	Red River Valley
2	Troika	Troika
3	Oh! Susanna!	Oh! Susanna!
4	Wave Of The Danube	Wave of Danube
5	Long Long Ago	Long Long Ago
6	Old Folks at Home	Old Folks at Home
7	Jambalaya	Jambalaya
8	Ding! Dong! Merrily On High	Ding! Dong!
9	Battle Hymn Of The Republic	Battle Hymn
10	The Old Gray Mare	The Old Gray Mare
11	American Patrol	American Patrol
12	Christmas Is Coming	Christmas Coming
13	Sippin' Cider Through A Straw	Sipping Cider
14	Christmas Sound	Christmas Sound
15	On London Bridge	On London Bridge
GOLDEN & POP		
16	House Of The Rising Sun	House of Rising
17	The Blue Bells Of Scotland	The Blue Bells
18	Beautiful Dreamer	Beautiful Dreamer
19	It's Been A Long, Long Time	Been a Long Time
20	O Sole Mio	O Sole Mio
21	Der Deitcher's Dog	Der Deitcher's Dog
22	Joy To The World	Joy to the World
23	Silent Night	Silent Night
24	Ave Maria	Ave Maria
25	Five Hundred Miles	Five Hundred Mil
26	Happy New Year	Happy New Year
27	It's Beginning To Look A Lot Like Christmas	Like Christmas
28	Jeanie With The Light Brown Hair	Jeanie
29	Music Box Dancer	Music Box Dancer
30	Go Tell It On The Mountain	Tell it on Mountain
31	Entertainer	Entertainer
32	Annie Laurie	Annie Laurie
33	Rumba Romance	Rumba Romance
34	The Last Rose Of Summer	Rose of Summer
35	The Old King Cole	The Old King Cole
JAZZ & FUSION		
36	Samba In June	Samba in June
37	Funk	Funk
38	I Can...	I Can...
39	Sea Shore	Sea Shore
40	Guitar&Saxophone	Guitar&Saxophone
41	The Hip Hop's Night	HipHop's Night
42	Blue Lunch	Blue Lunch
43	Cobweb	Cobweb
44	Wine	Wine
45	Jazz Old Man	Jazz Old Man
46	Dark Eyes	Dark Eyes
47	Carlos	Carlos
48	Sad	Sad
PIANO		
49	Lyrical Rondo	Lyrical Rondo
50	Rialto Ripples (Rag)	Rialto Ripples (Rag)
51	Neapolitan Song	Neapolitan Song
52	Waltzes	Waltzes
53	Turkish March	Turkish March
54	Schos Doll's Dance No. 2	Doll's Dance No.2

55	Minuet In D Major	Minuet in D Major
56	Inquietude	Inquietude
57	Italian Polka	Italian Polka
58	Moment Musical	Moment Musical
59	Prelude In C-Sharp Major	Prelude in C-Sharp Maj
60	The Happy Farmer	The Happy Farmer
61	The Rag-Time Dance	The Rag-Time Dance
62	Piano Sonata In C Major, K.330. III	Sonata K.330.III
63	Mazurka	Mazurka
64	Prelude In E Major	Prelude in E Major
65	Piano Sonata In A Major, K.331. I	Sonata K.331.I
66	Waltz For Piano In g-Sharp Minor	Waltz in g-Sharp
67	Gavotte	Gavotte
68	L' Arabesque	L' Arabesque
69	Austria Variation	Austria Variation
70	Schos Doll's Dance No. 7	Doll's Dance No.7
71	To A Wild Rose	To a Wild Rose
72	Gavotte I	Gavotte I
73	Waltz	Waltz
74	Minuet In G Major (BWV Anh. 116)	Minuet in G 2
75	Innocence	Innocence
76	Tchaikovsky Waltz	Tchaikovsky Waltz
77	Salut d' Amour	Salut d' Amour
78	Barcarolle	Barcarolle
79	Robot Doll	Robot Doll
80	Consolation	Consolation
81	2-Part Invention #13 In A Minor.B.W. Iii	Invention A 2 Voix
82	Minuet In G Major (BWV Anh. 114)	Minuet in G 1
83	Barcarolle	Barcarolle
84	Norwegian Dance No.2	Norwegian Dance No.2
85	Moseta Dance	Moseta Dance
86	The Small Gathering	The Small Gathering
87	The Return	The Return
88	The Wagtail	The Wagtail
89	Bulie Dance	Bulie Dance
90	Tender Blossom	Tender Blossom

Demo List

No.	Demo Name	LCD Name
1	Demo1	Demo1
2	Demo2	Demo2
3	Demo3	Demo3

Chord List

Chord Name (Abbreviation)	Normal Voicing	Chord	Display
Major [M]	1-3-5	C	C
Major sixth [6]	1-(3)-5-6	C6	C6
Major seventh [M7]	1-3-(5)-7	CM7	CM7
Major seventh sharp eleventh [M7#11]	1-(2)-3-#4-(5)-7	CM7#11	CM7#11
Major add ninth [Madd9]	1-2-3-5	Cmadd9	CM(9)
Major ninth [M9]	1-2-3-(5)-7	CM9	CM7(9)
Major sixth add ninth [6 9]	1-2-3-(5)-6	C6 9	C6(9)
Augmented [aug]	1-3-#5	Caug	Caug
Minor [m]	1-b3-5	Cm	Cm
Minor sixth [m6]	1-b3-5-6	Cm6	Cm6
Minor seventh [m7]	1-b3-(5)-b7	Cm7	Cm7
Minor seventh flatted fifth [m7b5]	1-b3-b5-b7	Cm7b5	Cm7b5
Minor add ninth [madd9]	1-2-b3-5	Cmadd9	Cm(9)
Minor ninth [m9]	1-2-b3-(5)-b7	Cm9	Cm7(9)
Minor eleventh [m11]	1-(2)-b3-4-5-(b7)	Cm11	Cm7(11)
Minor major ninth [mM7]	1-b3-(5)-7	CmM7	CmM7
Minor major ninth [mM9]	1-2-b3-(5)-7	CmM9	CmM7(9)
Diminished [dim]	1-b3-b5	Cdim	Cdim
Diminished seventh [dim7]	1-b3-b5-6	Cdim7	Cdim7
Seventh [7]	1-3-(5)-b7	C7	C7
Seventh suspended fourth [7sus4]	1-4-5-b7	C7sus4	C7sus4
Seventh flatted fifth [7b5]	1-3-b5-b7	C7b5	C7b5
Seventh ninth [7 9]	1-2-3-(5)-b7	C7 9	C7(9)
Seventh sharp evelenth [7#11]	1-2-3-#4-(5)-b7 or 1-(2)-3-#4-5-b7	C7#11	C7(#11)
Seventh thirteenth [7 13]	1- 3-(5)-6-b7 or 2- 3-5-6-b7	C7 13	C7(13)
Seventh flatted ninth [7b9]	1-b2-3-(5)-b7	C7b9	C7(b9)
Seventh flatted thirteenth [7b13]	1-3-5-b6-b7	C7b13	C7(b13)
Seventh sharp ninth [7#9]	(1)-#2-3-(5)-b7	C7#9	C7(#9)
Major seventh augmented [M7aug]	1-3-#5-7	CM7aug	CM7aug
Seventh augmented [7aug]	(1)-3-#5-b7	C7aug	C7aug
Suspended fourth [sus4]	1-4-5	Csus4	Csus4
One plus two plus five [1+2+5]	1-2-5	C1+2+5	C

MIDI Implementation Chart

Function		Transmitted	Recognized	Remarks
Basic	Default	1ch	ALL	
Channel	Changed	1-16ch	1-16ch	
Mode	Default	x	3	
	Messages	x	3	
	Altered	*****	x	
Note Number	Note	0—127	0—127	
	:True voice	*****	0—127	
Velocity	Note on	o 9nH,V=1-127	o 9nH,V=1-127	
	Note off	x (9nH,V=0)	o(9nH,V=0; 8nH,V=0-127)	
After Touch	key's	x	x	
	Ch's	x	x	
Pitch Bend		x	o	
Control Change	0	o	o	Bank Select
	1	x	o	Modulation
	5	x	o	Portamento Time
	6	o	o	Data Entry
	7	o	o	Volume
	10	x	o	Pan
	11	x	o	Expression
	64	o	o	Sustain Pedal
	65	x	o	Portamento ON/OFF
	66	o	o	Sostenuto Pedal
	67	o	o	Soft Pedal
	80	x	x	Reverb Program
	81	x	x	Chorus Program
	91	o	o	Reverb Level
	93	o	o	Chorus Level
120	x	o	All Sound Off	
121	x	x	Reset All Controllers	
123	o	o	All Notes Off	
Program Change	:true	*****	0—127	
System Exclusive		x	o	
System Common	:SongPosition	x	x	
	:Song Select	x	x	
	:Tune	x	x	
System Real Time	:Clock	o	x	
	:Commands	x	x	
Aux Messages	:LOCAL ON/OFF	x	x	
	:Active sense	o	o	
	:Reset	x	o	
Notes:				

- Mode 1: OMNI ON, POLY
- Mode 2: OMNI ON, MONO

- Mode 3: OMNI OFF, POLY
- Mode 4: OMNI OFF, MONO

- o: YES
- x: NO

WEEE-Declaration / Disposal

Your product is designed and manufactured with materials and components of high quality, which are recyclable and can be reused. The symbol means that your product should be disposed of separately from household waste when it reaches its end of life. Please dispose of this equipment at your local collection point or recycling center. Please help to protect the environment in which we all live.

All specifications and appearances are subject to change without notice. All information was correct at time of printing. Musikhaus Kirstein GmbH does not guarantee for the accuracy or completeness of any description, photograph or statement contained in this manual. Printed colors and specifications may vary slightly from product. Products from Musikhaus Kirstein GmbH are only sold through authorized dealer. Distributors and dealers are not agents of Musikhaus Kirstein GmbH and have no authority to bind Musikhaus Kirstein GmbH legally in any way. This manual is protected by copyright. Any copying or reprint, even in excerpts, is only allowed with written consent of Musikhaus Kirstein GmbH. The same applies to reproduction or copying of images, even in altered form.

The CE-marking which is made on your product and/or packing resp. user manual confirms the compliance of the product with all for this item related harmonized EC directives. You can download the EC declaration of conformity for this item under download link below:

http://www.kirstein.de/docs/Konformitaetserklaerung/CE_Konformitaetserklaerung_000xxxxx.pdf

Please replace the placeholder „xxxxx“ by the last 5 digits of the product article number.



Musikhaus Kirstein GmbH
Bernbeurener Str. 11
86956 Schongau - Germany
Telefon/Phone: 0049-8861-909494-0
Telefax/Fax: 0049-8861-909494-19

