

CLASSIC CANTABILE

SP-250 stage piano



Instruction manual

ArtNo: 00037155
Version: 07/2021

Congratulations!

Before you switch on the device, we recommend that you read these operating instructions carefully. Keep the operating instructions in a safe place.

Location

To avoid serious damage, discoloration and malfunction, never expose your device to the following environmental conditions:

- Direct sunlight
- High temperatures (near radiators or in the car during the day).
- High humidity
- Excessive dust
- Humidity and moisture
- Strong vibrations

Power supply

- Make sure to use a suitable power supply that matches the input voltage of the respective country.
- Switch the device off (OFF) when not in use.
- If you do not use the device for a longer period of time, disconnect the power plug from the socket.
- Do not use the device during thunderstorms.
- Avoid using an outlet that has devices that require a lot of power, such as electric heaters or ovens. Furthermore, avoid the use of multiple sockets, because this can affect the sound quality, cause malfunctions and possible damage.
- To prevent damage to the unit or other equipment connected to it, turn OFF all equipment when wiring or disconnecting.

Handling and transport

- Never use force on the controls, connections or other parts of the instrument.
- Do not tear at the connectors, but pull them out carefully.
- Disconnect all cable connections before transporting the device.
- Avoid physical shock by shaking or dropping.
- Do not place heavy objects on the instrument, this may cause scratches or more serious damage.

Cleaning

- Clean the device with a dry, soft cloth.
- To remove stubborn dirt, use a slightly damp cloth.
- Never use alcohol or chemical cleaning agents.
- Avoid placing vinyl on the surface (vinyl will stick and discolor the surface).

Electrical compatibility

This instrument has digital circuitry and may cause interference if placed too close to radio or television equipment. If such interference occurs, move the instrument farther away from the affected equipment.

Do not open the device

In the event of a defect or malfunction, take the device to a specialist workshop.

Table of contents

Controls and display	5
Back	5
Front	5
LCD	7
Structure	8
Power supply	8
Connections	9
Headphones	9
Audio equipment	9
MP3 player	9
Computer / MIDI device	10
Foot switch	10
Pedal	10
Microphone	11
Quick start	11
Switch on	11
Volume	11
Playing the demo songs	11
Playing the sounds	12
Playing the styles	12
Playing the songs	12
Recording	13
Advanced operation	13
Selection of the main sound	13
Dual mode	13
Lower mode	14
Touch Response	14
Sustain	15
Pitch Bend	15
Transpose	15
Piano mode	15
Twinova	16
Octave	16
Auto Accompaniment	17
Rhythm track	17
All tracks	17
Ranges in the automatic accompaniment	18
Volume	19
Fingering	19
Tempo	21
Fade In/Out	21
Metronome	21
One-finger operation	21
Mixer	22
Harmony	22
Assistance function	23
Calling the function	23
Guitar mode	23
Piano mode	25
DSP effect	25
Pedal function	26
Function menu	27
Tuning	27

Split function	28
Time signature	28
Pedal	28
EQ - Equalizer	29
Reverb	29
Reverb level	29
Chorus	30
Chorus level	30
Harmony Art	31
MIDI In	32
MIDI Out	32
Switch off	32
Registration memory	32
Settings	33
Calling up the settings	33
Selection of the memory location	33
Recording	33
Starting the recording	34
Stop recording	34
Playback	35
Delete a song	35
Song	35
Listen to the songs	35
Song settings	36
Learning mode	36
Chord Dictionary - Chord Dictionary	37
USB drive	38
Basic operation	38
Playing MIDI files	39
Loading	39
Backing up data to the U-Disk	40
Deleting data on the U-Disk	40
Formatting the U-Disk	41
Keys / letters overview	41
MIDI	41
What is MIDI?	41
MIDI devices	41
Data exchange with the computer	42
Restore factory settings	42
Help with malfunctions	43
Specifications	44
Sounds overview	45
Styles overview	51
Song directory	53
Demo songs directory	54
MIDI implementation	55
WEEE Declaration / Disposal	56
Manufacturer information	56

Controls and display

Back

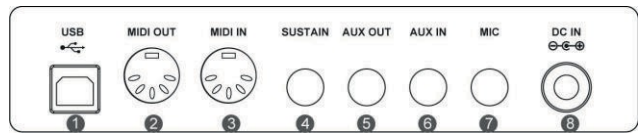

1	USB: Connection socket for a Computer	5	AUX OUT: connection possibility for audio Equipment
2	MIDI OUT: connection jack (the MIDI IN jack of an external MIDI device is connected here)	6	AUX IN: jack for MP3 or CD player connection
3	MIDI IN: Connection jack (the MIDI OUT jack of an external MIDI-device is connected to this socket)	7	MIC: Microphone jack
4	SUSTAIN: socket for the pedal connection	8	DC IN: socket for the power supply unit

Front

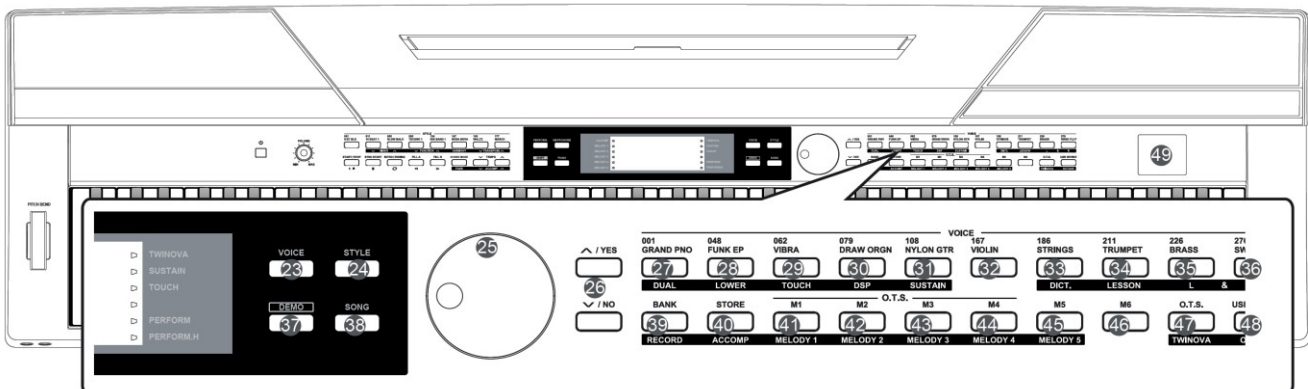
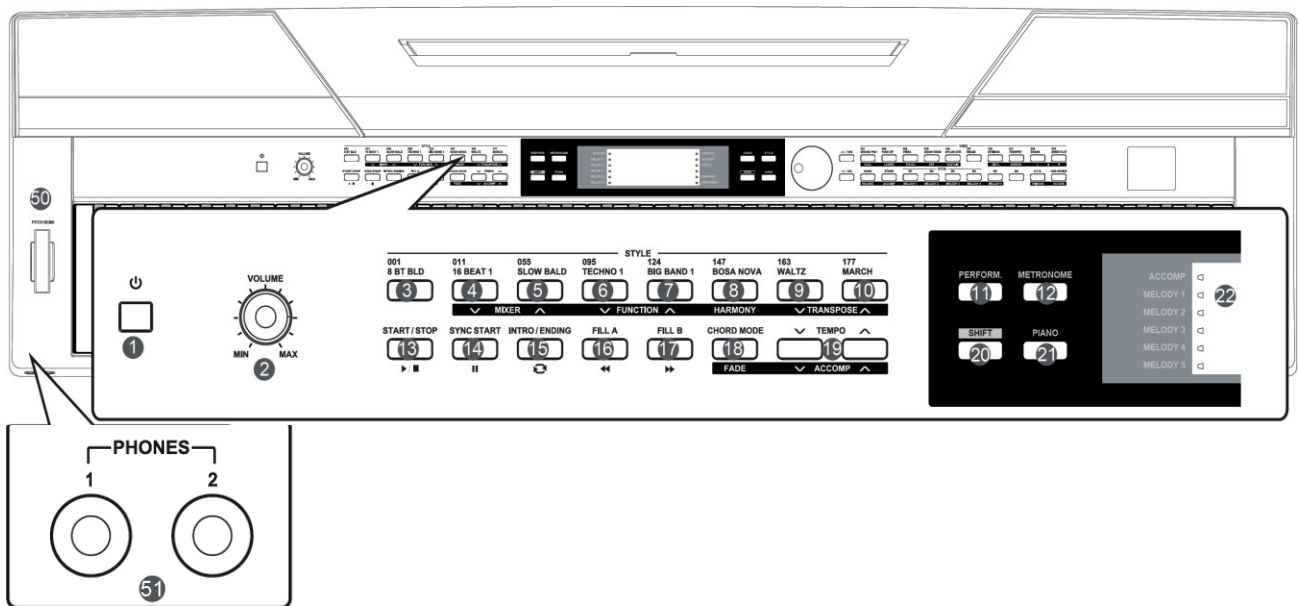

Key assignment		With SHIFT key
1	POWER: On/Off switch	
2	VOLUME: Volume control	
3	Style direct selection buttons	
4		Mixer +
5		Mixer -
6		FUNCTION -
7		FUNCTION +
8		HARMONY: on/off
9		TRANSPOSE -
10		TRANSPOSE +
11	PERFORM: assistance function on/off	
12	METRONOME: Metronome on/off	
13	START/STOP button	
14	SYNC START: on/off	
15	INTRO/ENDING	
16	FILL A	
17	FILL B	
18	CHORD MODE: Chord mode	FADE: on/off
19	TEMPO+/-	ACCOMP +/-: Volume for the auto accompaniment
20	SHIFT: function key	
21	PIANO: Mode on/off	
22	LCD display	
23	VOICE: to the voice mode	
24	STYLE: to the style mode	
25	DATA: rotary wheel: changes the value of a Parameters	
26	+ / YES, - / NO: changes the value of a Parameters	
27	Direct selection for sounds	DUAL: Switching the function on/off
28		LOWER: Switching the function on/off
29		TOUCH: Touch sensitivity
30		DSP: Switching the function on/off
31		SUSTAIN: Switching the function on/off
32		DICT: Switching the dictionary function on/off
33		

34		LESSON: Switching the learning function on/off
35		LEFT HAND: left hand in the learning function
36		RIGHT HAND: right hand in learning function
37	DEMO: starts or stops the playback of a Demos	
38	SONG: activates the song mode	
39	BANK: changes the memory locations	RECORD: Switching the recording function on/off
40	STORE: stores settings	ACCOMP: selects the automatic accompaniment for recording
41	M1 to M6: calls up settings stored there. In O.T.S. mode, only M1 to M4 can be called up.	Melody 1-5: Selection of the melody track for recording
42		
43		
44		
45		
46		
47	O.T.S.: switches the One Touch function TWINOVA: switches the function on or off	
48	USB DEVICE: calls the corresponding OCTAVE: setting the parameter menu	
49	USB socket	
50	PITCH BEND: rotary wheel for changing the pitch of the sound	
51	PHONES: headphone jacks 1/4"	

LCD

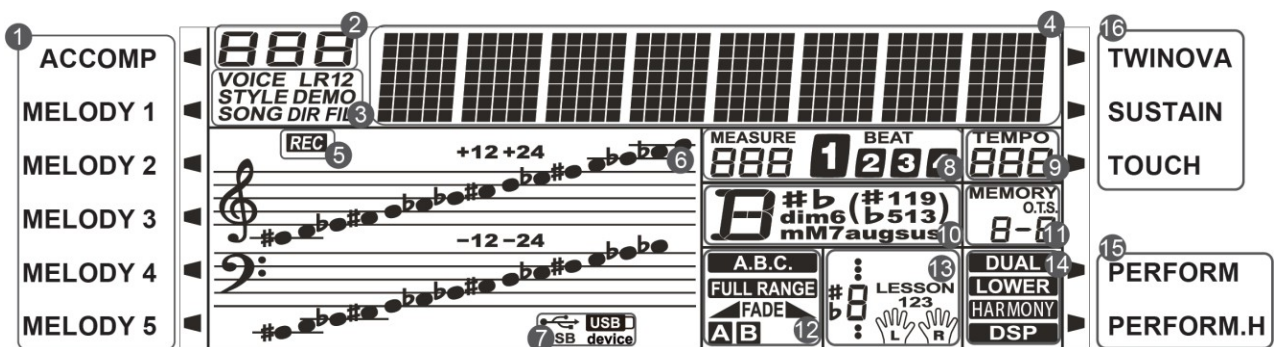

1	Auto Accompaniment / Melody tracks	7	USB cable / drive	13	Notes / Lesson (learning function)
2	Number	8	Time signature/ beat	14	Dual, Lower, Harmony, DSP
3	Voice, Style, Demo, Song, You, File	9	Tempo	15	Perform / Perform H.
4	String	10	Chord	16	Twinnova / Sustain / Touch
5	Recording	11	Memory number / One Touch setting		
6	Violin/Bass clef	12	A.B.C / FULL RANGE / Fade / Section		

Structure

Please go through the section carefully before you switch on the device. Please always use a suitable power supply, 12V DC. For your safety, unplug the instrument during lightning storms or whenever it is not in use.

Structure of the music stand

Place the music stand in the recess of the console (see drawing).

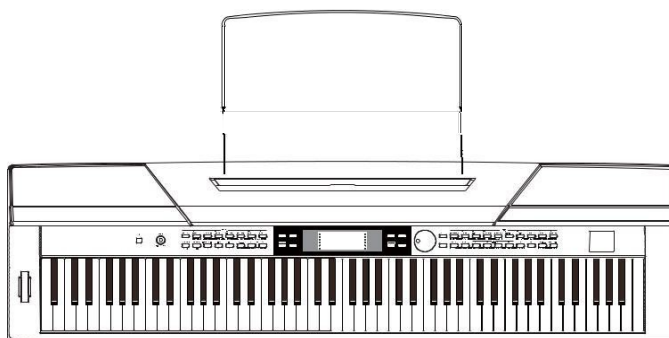

Power supply

1. Turn the volume of the instrument and any connected devices to minimum.
2. Connect the power supply to the corresponding socket on the piano.
3. Connect the other end of the power supply to the wall outlet.
4. Switch on the device; the display shows "Loading".
5. To turn off the piano, press and hold POWER until the display goes blank.

Please note that the device switches itself off if it is not used for more than 30 min.

If you do not use the device for a longer period of time, please disconnect it from the power supply.

The same applies during a thunderstorm.

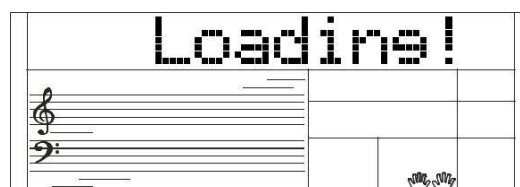
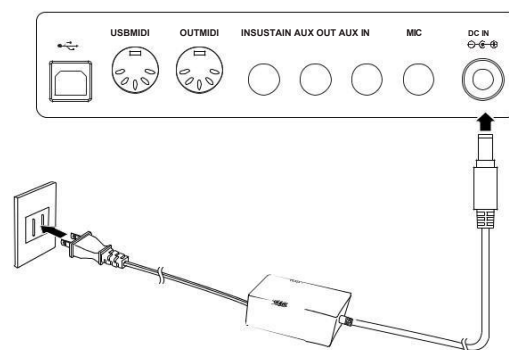

Connectors headphones

You can connect standard headphones to this jack if you want to play at rest or late at night.

"Headphone Jack 1" is the jack 1 for the headphones. If you connect headphones here, you can hear the piano sound through the headphones as well as from the piano itself.

"Headphone Jack 2" is the jack 2. Once you connect to this jack, the sound transmission through the piano is stopped and you can only receive the piano sound through the headphones.

Please turn down the volume if you play with headphones for a long time, otherwise your hearing could be permanently damaged.

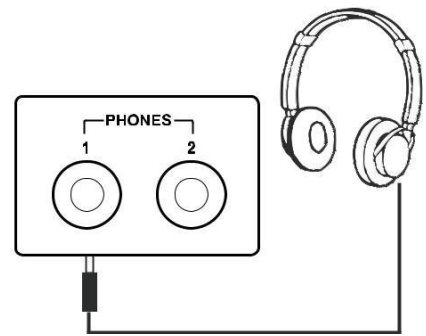

Audio equipment

The AUX OUT jack on the rear panel of the piano is a connection point for amplifiers, stereos, mixing consoles or recorders. Use an audio cable to connect the instrument to the external device.

Before connecting, please turn the volume to minimum to prevent damage to speakers.

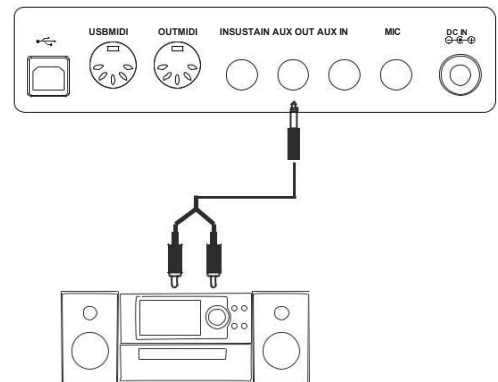

MP3 player

Connect the output of an MP3 or CD player to the AUX IN jack on the back of the unit. The incoming signal will be mixed with the piano signal and you can play along with the music.

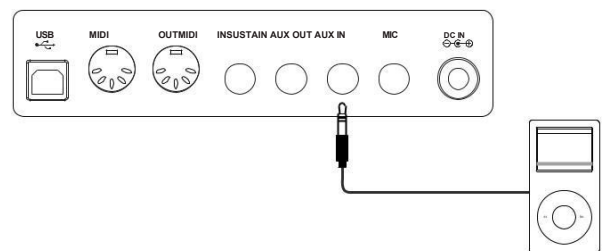

Computer / MIDI device

MIDI OUT

Connect the MIDI output of the piano to the MIDI input of another device. All data will be transmitted to the external devices and the piano will be used as a MIDI controller.

MIDI IN

If you connect the MIDI input of the piano to the MIDI output of another device, you can use the piano as a sound source.

USB

If you connect the computer and the piano via a USB cable, you can exchange data between the devices, e.g. you can transfer songs to the computer and save them there as MIDI files.

Please note: Do not select "USB Audio Device" for input and output, otherwise the sound will overlap.

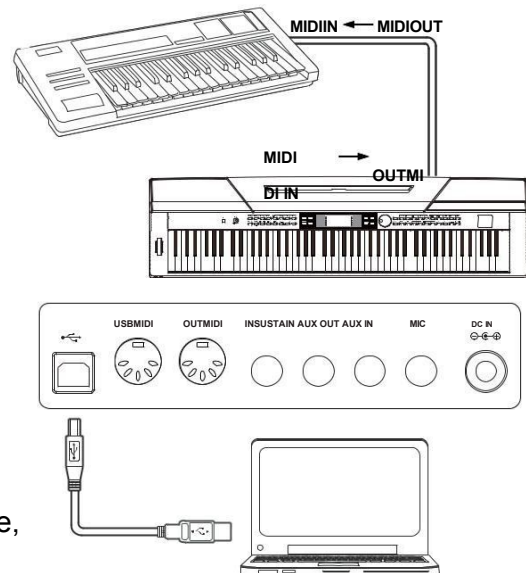

Foot switch

To achieve a natural effect, you can connect a foot pedal to turn a sustain on or off. Foot switches from other manufacturers are also supported. Please make sure that the device is switched off when you connect switches of other manufacturers, otherwise switching on and off could be reversed!

You can also set other functions on the switch. To do this, go to the function menu.

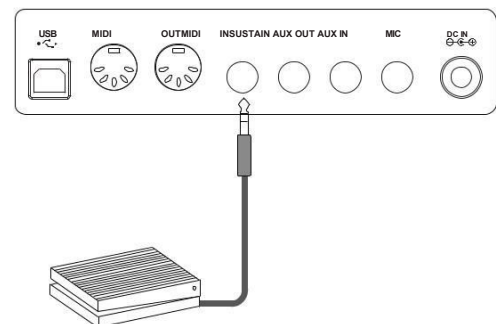

Pedal

To simulate an acoustic piano, optional separately available pedals can be connected. The jack is located on the back of the unit.

Sustain pedal: The right pedal lets the notes decay as if you were holding down the keys.

Sostenuto pedal: The middle pedal generates a sustain-like effect, i.e. the tones sound longer. The effect only applies to notes that have already been played. Tones that you play after pressing the middle pedal are not affected.

Soft pedal: When you press the left pedal, the volume of the piano is reduced and the timbre of the notes played is slightly altered.

You can also set other functions on the switch. To do this, go to the function menu.

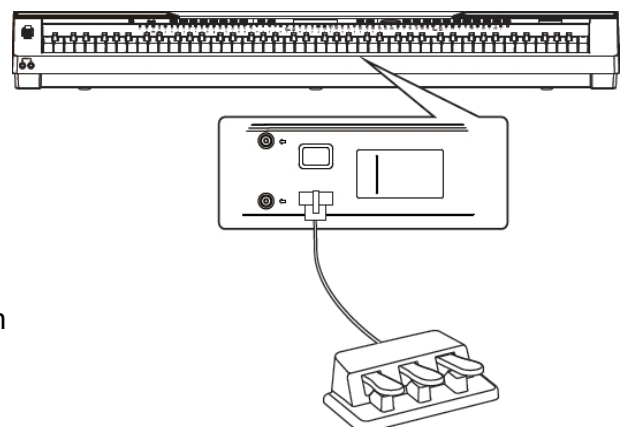

Microphone

1. Set the volume to minimum.
2. Connect the microphone to the MIC jack on the rear panel.
3. Turn on the device and adjust the volume.

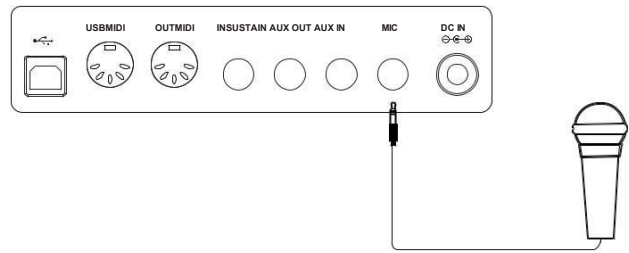

Quick start

Switch on

1. Make sure that the device has been connected correctly.
2. Press POWER; the display shows "Loading". If the display remains dark, please check the power supply.

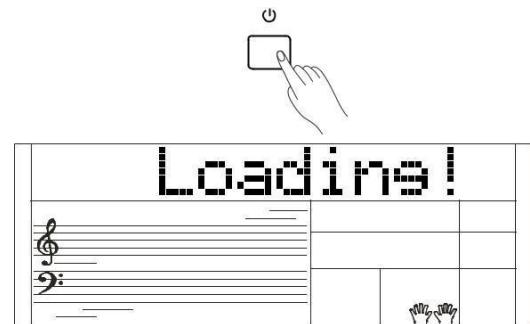

Volume

Turn the VOLUME knob to the right to increase the volume or to the left to decrease it.



Playing the demo songs

The piano has five wonderful demo songs. You can find a list of the demo songs in the appendix.

1. Press DEMO to start a demo song; the display shows the name and number of the song.
2. Use the DATA dial or the +/YES and -/NO keys to select a demo song. The display shows the name and Number of the song. The songs are displayed in a Endless loop played.
3. to stop the demo song, please press the START/STOP keys. Press again or Press DEMO to enter the demo mode. leave

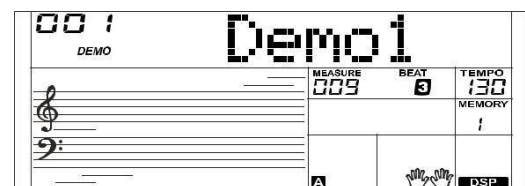
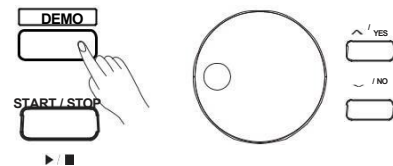

Playing the sounds

The piano has over 600 fantastic sounds (voices). You can find a list in the appendix.

1. Press VOICE; the display will show the name and number of the sound.
2. Use the DATA dial or the +/YES and -/NO keys to select a sound.
3. Play on the keyboard and listen to the Sound!

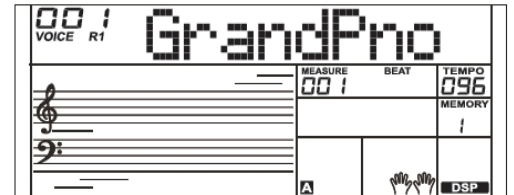

Playing the styles

The piano has 230 different fantastic styles as well as 10 user style
A list can be found in the appendix.

1. Press STYLE; the display shows the name and number of the style.
2. Use the DATA dial or the +/YES and -/NO keys to select a style.
3. Press START/STOP; the rhythm starts immediately.

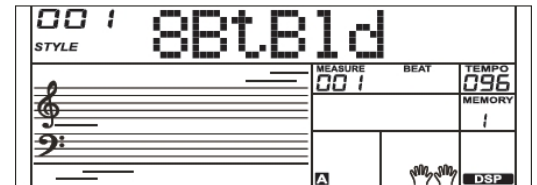

Playing the songs

The piano has 120 different fantastic styles as well as 5
user songs.
A list can be found in the appendix.

1. Press SONG; the display shows the name and number of the song.
2. Use the DATA dial or the +/YES and -/NO keys to select a style.
3. Press START/STOP; the playback will be stopped, press the button again and then the songs will be played in turn
4. Press STYLE or VOICE to exit the mode. (When playback is paused)

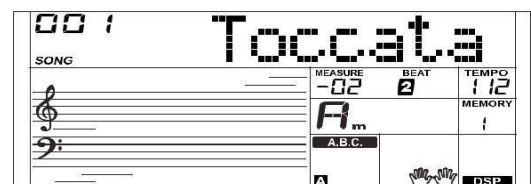
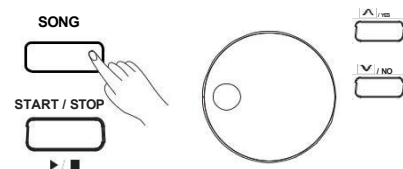

Recording

The piano can record 5 user songs.

1. Press SHIFT and RECORD and select with the rotary knob or the keys +/YES or -/NO to select the song you want to record.
2. Press SHIFT and RECORD again and prepare the recording by selecting Sound and select styles and other settings make.
3. Press START/STOP or start to start the recording.
4. To stop recording, press SHIFT and RECORD again. The song will now be played back continuously.
5. Press SONG to select a user song (121-125) for playback.

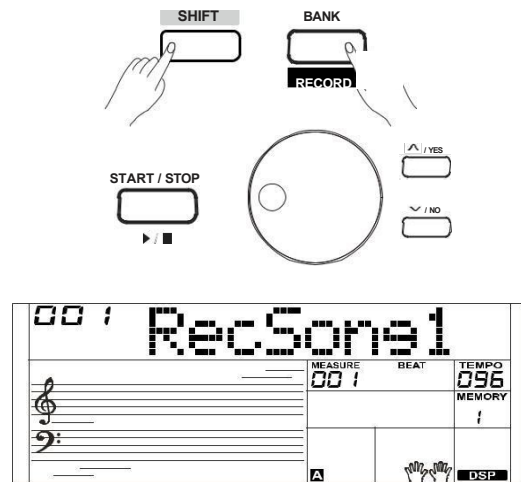

Advanced operation

This piano has over 600 exceptionally realistic sounds, the Voices. A list of all the sounds can be found in the appendix.

Selection of the main sound

Press the VOICE key. The display shows "VOICE R1" and the number and name of the sound.

Select a voice by using the rotary wheel or the +/YES and -/NO keys. You can also select a voice directly using the voice keys.

Each of the voice buttons has three voice Sources: R1, R2, and L1. When the dual or Lower function is active, you can press the voice key between the sound sources change. The corresponding indicator light lights up.

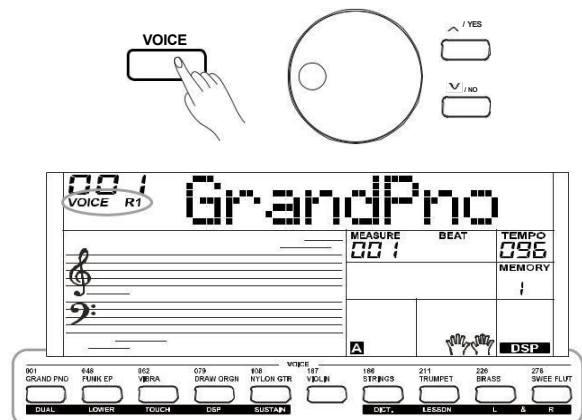

Dual mode

Press the SHIFT and DUAL keys. Two different voices sound simultaneously. The number of the dual voice is shown in the display.

Select a dual voice (= VOICE R2) by pressing

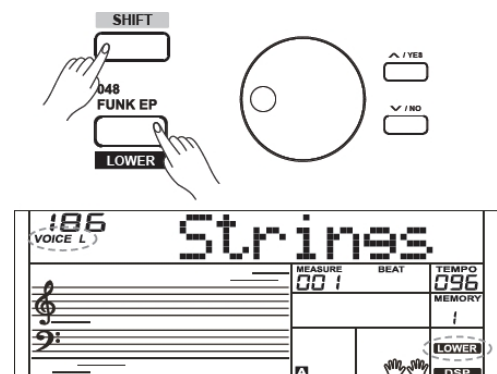

When the keyboard is in split mode, only the area for the right hand is occupied by the dual voice, the one for the left hand is not.

Lower mode

To play with two different sounds "side by side", press the SHIFT and LOWER keys. The number of the lower voice is displayed in the display (VOICE L). You can select a lower voice by using the rotary knob or the +/YES and -/NO keys or the voice keys.

Pressing the SHIFT and LOWER keys again will exit the mode.

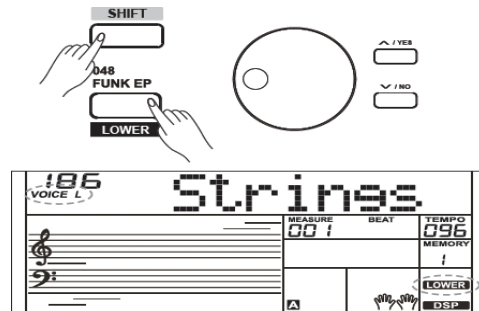

The **splitpoint** represents the separation between VOICE L and VOICE R1/R2. It is located at the factory (default) at F#3 (34). However, you can assign it to any key. Please refer to the chapter "Setting the split point".

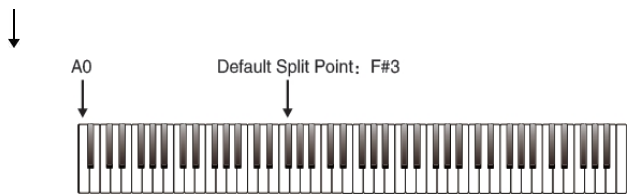

Velocity - Touch Response

The keyboard is equipped with a touch response function, which means that the force of your touch directly affects the sound, just like on an acoustic instrument.

Press SHIFT and TOUCH, the display will show the current value. The range is from OFF to 3 (hard). The factory setting is 2. Use the rotary knob or the +/YES and -/NO keys to change the value or press + and - simultaneously to return to the factory setting.

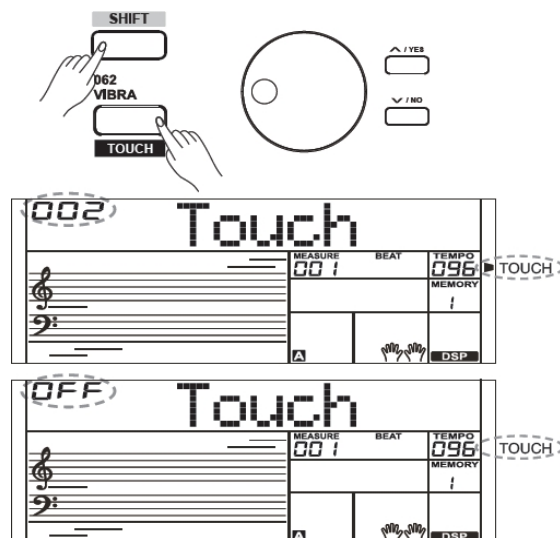

Sustain

To turn the function on or off, please press SHIFT and SUSTAIN.

To achieve a more natural sustain, you should use a sustain pedal. Please also read the chapter "Pedal functions".

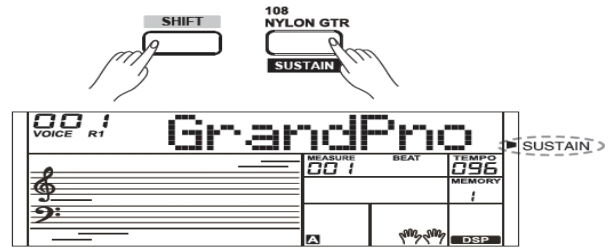

Pitch Bend

Move the Pitch Bender back and forth while you play. You can use it to imitate the bending of other instruments such as guitar, violin, saxophone, etc. It will return to its original position by itself when you release it.

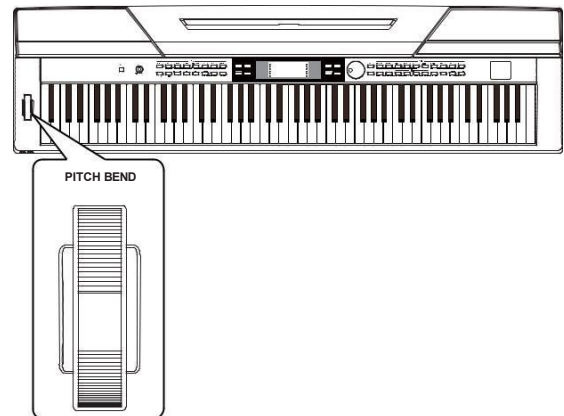

Transpose

This function allows you to change the pitch of the instrument. The range is one octave in semitone steps (-12 to +12).

Press SHIFT and TRANSPOSE + or -, "****Transpos" appears in the display. You can now change the pitch with the TRANSPOSE + or - keys. Press both keys simultaneously if you want to restore the factory setting "000Transpos". The transposition applies to all parts of the music and the keyboard.

Use the rotary wheel or the keys +/YES and -/NO or TRANSPOSE + or - to change the value. Press +/YES and -/NO or TRANSPOSE + and - simultaneously to reset the value to the factory setting.

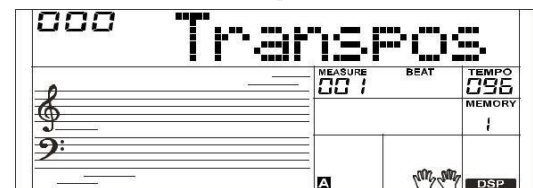
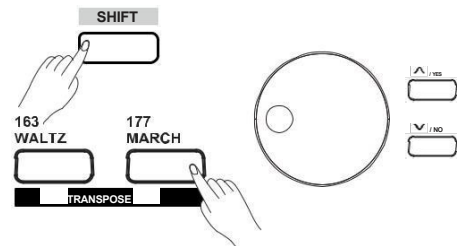

Piano mode

You can enter the Piano mode by pressing a single button. Press the PIANO button to enter or exit the mode.

Auto Accompaniment works just like in other modes; it takes over the rhythm part. Chord mode is automatically turned off.

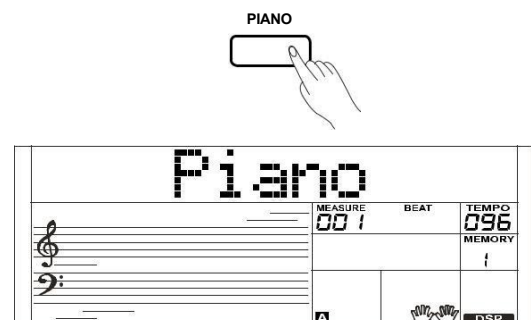

Twinova

In Twinova mode, the keyboard is divided into two sections with the same pitch and voice.

1. To start (or exit) the mode, press the SHIFT and TWINOVA keys. The indicator lamp "Twinova" lights up. In this mode, the "Dual" and "Lower" functions are not available, the split point is at E3 (32),
2. Voice selection: In Twinova mode, the active voice is the Upper Voice. You can select this as usual before activating the mode.
3. Setting the split point: see the corresponding chapter.
4. Octave setting in active Twinova mode: Press OCTAVE; the display briefly shows the current value. You can change it with DIAL or +/-; the range is from -1 to 1.

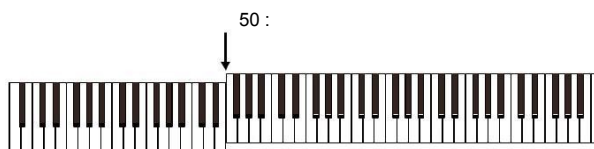
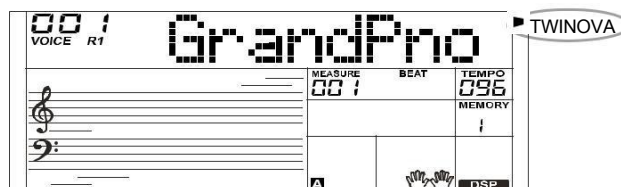
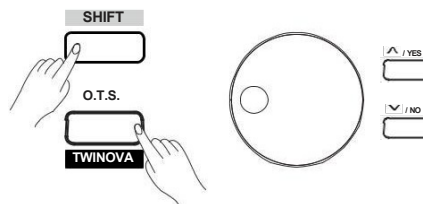

Please note

In demo and song mode, the Twinova function is not available, and the octave function may be restricted in the lowest and highest ranges.

Octave

This function changes the pitch up or down by one octave. Adjustment is only possible in Twinova mode. When you exit Twinova mode, the settings are reset.

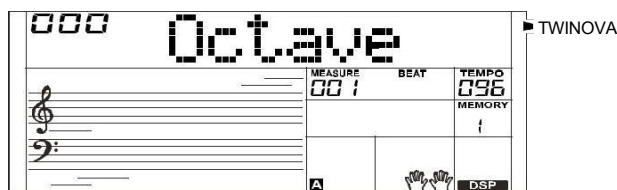
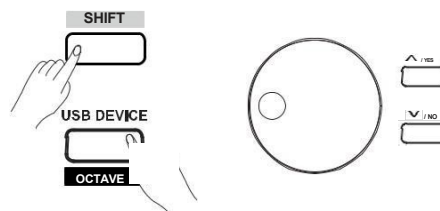

1. In Twinova mode, hold down the SHIFT- key and press OCTAVE at the same time; the display briefly shows the current setting "xxx Octave". You can now change the setting using the rotary knob or the +/YES or -/NO keys.
change. The range is from -1 to +1. Press the +/YES and -/NO keys simultaneously to restore the factory setting 000.
2. If no indication is made within 5 seconds, the system automatically exits the octave mode.

Auto Accompaniment

This function provides you with a full band or orchestra as accompaniment. Depending on the chords you play with the left hand, the auto accompaniment adjusts itself independently. The instrument has over 230 styles in a variety of different musical genres. Try out different ones, a list of available styles can be found in the appendix.

Rhythm track

1. Press STYLE, the display shows Name

START / STOP SYNC START and number of the style and the indicator lamp lights up.

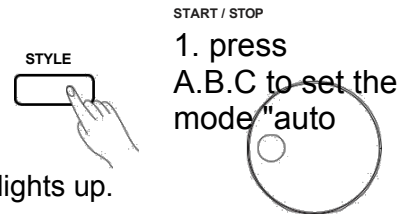

2. Select a style. To do this, use the rotary wheel or the +/YES and -/NO keys. You can also select the styles directly using the style buttons.
3. Press START/STOP to start the rhythm track of the auto accompaniment.
4. Press START/STOP to stop the playback.

All tracks

bass chord"; the indicator light lights up. The range for the left Hand becomes the area for the Auto Accompaniment. Chords that you can play in this area, will automatically detected and used as a basis for the fully automatic accompaniment used.

2. press SYNC START and play a chord around the auto-accompaniment for all tracks. Press START/STOP to start the auto accompaniment for

start the rhythm track and play You play a chord with the left hand. The Auto Accompaniment for all tracks will started.

The instrument includes 10 user (user) styles. You can use the software "Use OC Suite" to create your own styles.

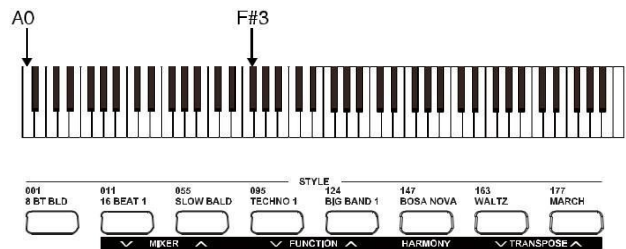
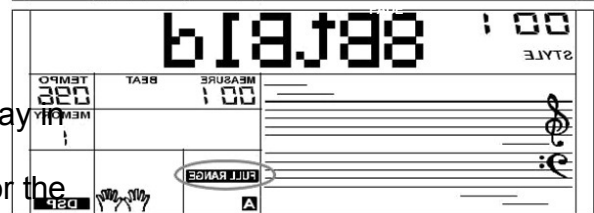
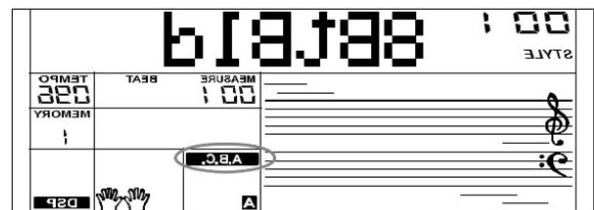

Ranges in the automatic accompaniment

There are several types of auto accompaniment sections that allow you to customize the accompaniment arrangement to the song you are playing, such as Intro, Main (A, B), Fill In (A, B) and Ending. You can easily switch between them while playing to create your own personal arrangements.

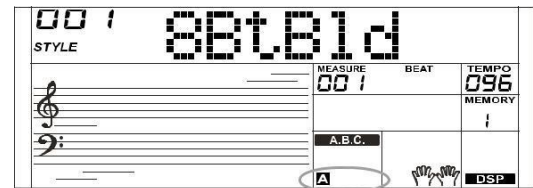

Intro

This section is used for the introduction of a piece. As soon as the intro is finished, the auto accompaniment changes to the main part.

Main part

This is the main part of the piece, an accompaniment pattern is played over several bars, repeated until another section is selected.

Fill In

This section provides dynamic variations that make your playing sound even more professional. As soon as the Fill In is finished, the auto accompaniment returns to the main pattern (A, B).

Ending

This section is used to end the song. After an ending, the auto accompaniment stops. The length of an ending depends on the selected style.

Please note

A selected fill is repeated as long as you keep the A/B button pressed.

Playing with different areas

1. Press STYLE.
2. Select a style.
3. Press CHORD MODE.
4. Press SYNC.
5. Press A.
6. Press INTRO/ENDING. Now the "A" flashes on the display, the style is ready to play.
7. As soon as you play a chord with the left hand, the auto accompaniment starts. When the intro is finished, the auto accompaniment changes to the main pattern A.
8. Press B. A Fill In is played, followed by Mainpattern B.
9. Press INTRO/ENDING. The ending is played, then the auto accompaniment stops.

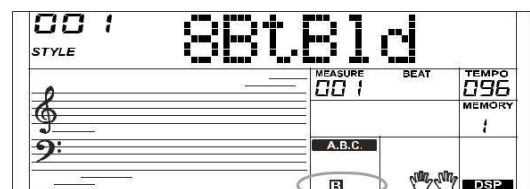
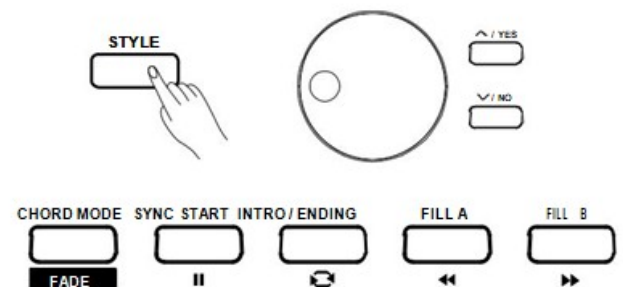

Volume

1. Hold down the SHIFT key and press ACCOMP+ or ACCOMP-, the display shows the value of the currently set volume. The value range is from 0 to 127.
2. Use ACCOMP+/- or +/YES and -/NO to change the value.
3. To mute the auto accompaniment, press SHIFT, ACCOMP+ and ACCOMP- simultaneously. The display will show "Off Accomp". Press the keys again to hear the accompaniment again.

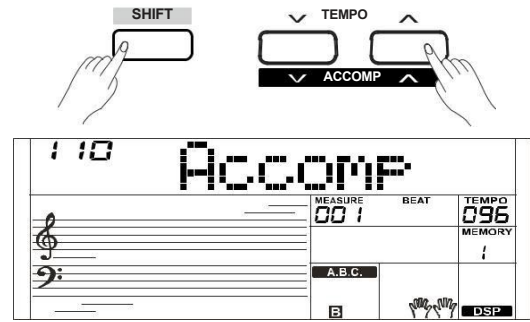

Fingering

Fingering is the way the system recognizes how you play the chords with your left hand. There are two types, described below: Chord Fingering mode and Full Range mode.

Basics

A chord consists of three or more notes played simultaneously. For example, a C major chord consists of the notes C as the root, E as the third note (third) of the C major scale, and G as the fifth note (fifth) of the C major scale.

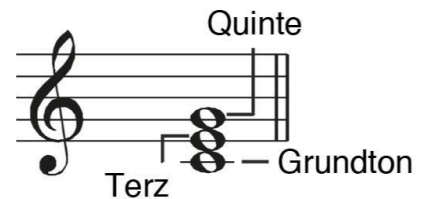

As shown in the previous example, the lowest note is called the root. The interval to the root (minor or major third) determines whether a triad is a minor or major chord.

The basic characteristic of the triad is preserved even if we change the order to play different inversions.

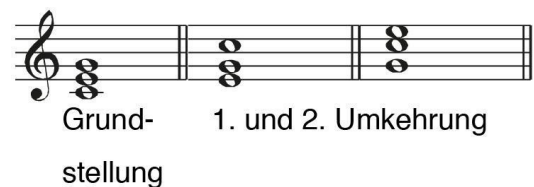

Frequent triads

Major	Major	 <p style="text-align: center;">Dur-Dreiklang Moll-Dreiklang</p>  <p style="text-align: center;">Verminderter Übermäßiger</p>
Minor	Minor	
Excessive	Augmented	
Decreased	Diminished	

The name tells which root it is, whether it is a major or minor chord, or a diminished one, etc.

The chord name is composed of the root note and the tonal gender. In the example on the right, the chord is a C minor chord.

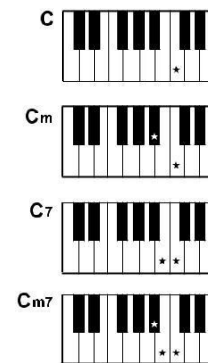
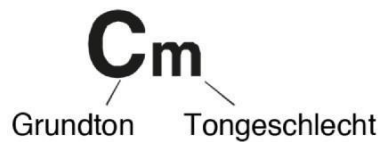

Single finger

In this mode you can play the whole variety of chord by pressing only a few keys.

Multi Finger

This mode allows playing with normal fingering. Try to play the 32 chords in C listed in the adjacent table.

Full Range Mode

In this mode, the keyboard recognizes only chords with normal fingering.

0 C	1 C ₆	2 C _{M7}	3 C _{M7} (#11)	4 C _M (9)	5 C _{M7} (⁹)
6 C ₆ (⁹)	7 C _{aug}	8 C _m	9 C _{m6}	10 C _{m7}	11 C _{m7} (^{b5})
12 C _m (9)	13 C _{m7} (⁹)	14 C _{m7} (¹¹)	15 C _m M ₇	16 C _m M ₇ (⁹)	17 C _{dim}
18 C _{dim7}	19 C ₇	20 C _{7sus4}	21 C ₇ (^{b5})	22 C ₇ (⁹)	23 C ₇ (^{#11})
24 C ₇ (¹³)	25 C ₇ (^{b9})	26 C ₇ (^{b13})	27 C ₇ (^{#9})	28 C _{M7aug}	29 C _{7aug}
30 C _{sus4}	31 C ₁₊₂₊₅	Noten in Klammern sind optional.			

Tempo

Each style in this instrument has been programmed with its own tempo. Nevertheless, the tempo can be adjusted to your liking. To do this, use the TEMPO+ or - buttons. The value of the tempo will start flashing. You can also change the tempo with the rotary wheel. To restore the original tempo, press the TEMPO + and - keys simultaneously.

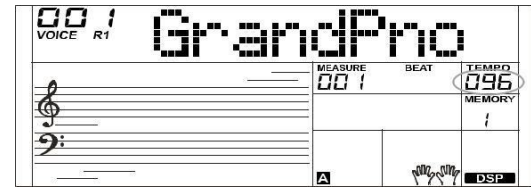
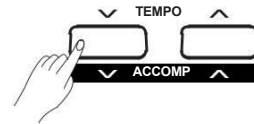

Fade In/Out

1. Fade In: Press SHIFT and FADE before the Style is played. The indicator lamp lights up and flashes. The style starts smoothly by increasing the volume.
2. Fade Out: To let the Style fade out smoothly, press the SHIFT and Fade buttons during playback. The indicator lamp lights up and flashes. The fade duration is 10 seconds.

CHORD MODE

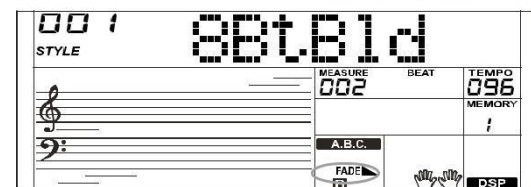
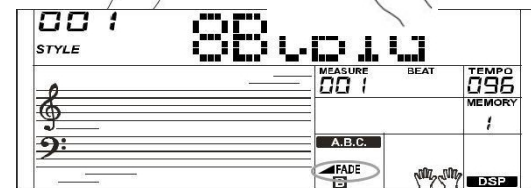

Metronome

Press the METRONOME button to turn the metronome on or off. For more information about the setting, see the chapter "Function Menu".

Start the auto accompaniment, the metronome will adjust the beat. When recording, the metronome is available, but its sound is not recorded.

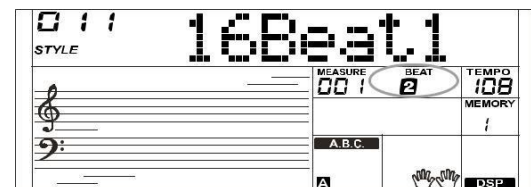
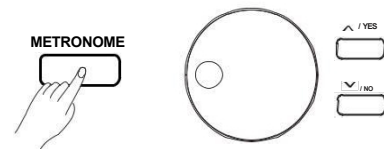

One-finger operation

This function is a very comfortable interior, where you can find virtually all View settings related to auto accompaniment at the touch of a button.

1. Press O.T.S. to change the settings for the currently selected style; the indicator lamp lights up.
2. Press one of the setting buttons M1-M4. Various settings such as Voice, Effect, etc., which are correlated with the current Style, will be displayed. The O.T.S. parameters include: Part on/off, Voice Change, Voice Volume, Reverb and Chorus levels.

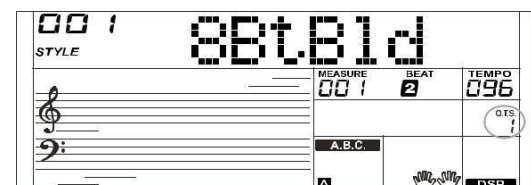
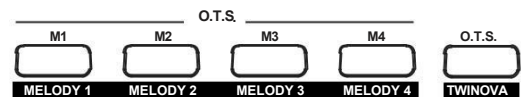

In this mode, the A.B.C. function is automatically switched on. Memory cannot be registered.

Mixer

With this function the volume of the different tracks can be changed.

1. Press the SHIFT and MIXER keys. The display shows the first parameter and the current number.
2. Adjust the volume to your liking (in the range from 0 to 127) using the rotary wheel or the +/YES and -/NO buttons.
3. Press SHIFT and MIXER again to select the other parameters.

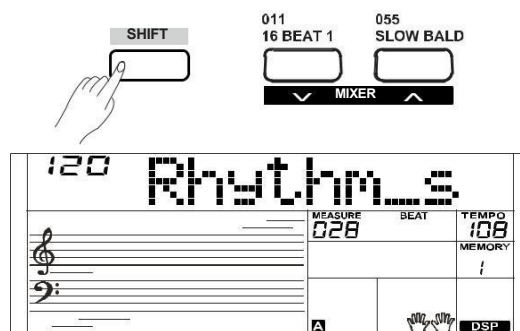

If no input is made within 5 seconds, the function is terminated. The following parameters can be set:

Parameter	Display indication	Area
Rhythm s volume	XXX Rhythm_ s	0-127
Rhythm m volume	XXX Rhythm_ m	0-127
Bass volume	XXX Bass	0-127
Chord 1 volume	XXX Chord1	0-127
Chord 2 volume	XXX Chord2	0-127
Chord 3 volume	XXX Chord3	0-127
Phrase 1 volume	XXX Phrase1	0-127
Phrase 2 volume	XXX Phrase2	0-127
Voice R1 volume	XXX Upper 1	0-127
Voice R2 volume	XXX Upper 2	0-127
Voice L volume	XXX LOWER	0-127
U_Disk midi play	XXX U_Disk	0-127

Harmony

You can add different harmony notes to the notes of the right hand.

Harmony type selection

1. Press SHIFT and HARMONY; the display shows "Duet" and the indicator lamp lights up.
2. Use the rotary wheel or the +/YES and -/NO keys to change the type of harmony. The

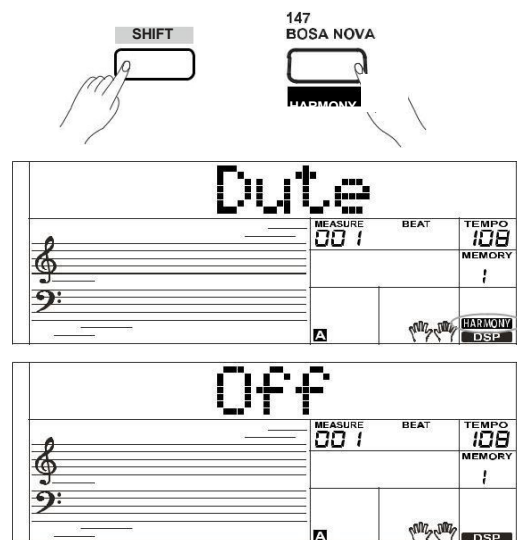

Instrument has 26 harmony effects. You can find the directory in the appendix.

3. Press SHIFT and HARMONY again to turn the effect on; the display shows "off".

Applying the harmony effect

1. Turn on the auto accompaniment.
2. Play a chord with the left hand.
3. Play some notes with the right hand. The harmony notes are added automatically.

The harmony functions 1+5, octave 1-2, echo 1-4, tremolo 1-4 and trill 1-4 can always be applied. Other harmony functions are only available when auto accompaniment is active.

Harmony effects cannot be recorded.

Assistance function

There are two sounds available in this function: Guitar and Piano. It is an easy-to-use function that can make playing more interesting for guitarists and keyboard players. The assistant is equipped with many wonderful phrases!

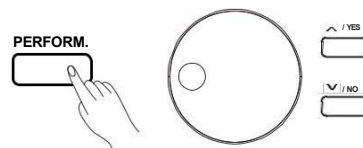

Calling the function

1. press the PERFORM key to select the wizard. Ex works the Guitar mode switched on and in the display appears the name and number of the Guitar sounds.
2. Change the sound using the +/Yes or -/No buttons.
3. The display shows "4-4" as the time signature. You can change the time signature in the function menu. The following can be selected: 2/4, 3/4, 4/4 and 6/8.
4. You can set the tempo with the TEMPO+ and TEMPO- keys.

Guitar mode

In this mode you can play on the keyboard like on a guitar. For example, strumming (5), broken chords (5), echoism (5), and two endings are possible. The keyboard is divided as follows:

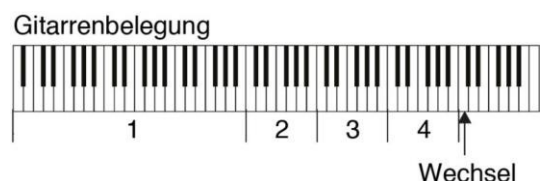

1. A0 to B3 - Chord Part area. Here you can play chords.
2. C4 to B4 - white keys only: Broken Chord section.
3. C5 to A5 - only the white keys: corresponding guitar strings. Here you can play a free solo.
4. C6 to G6 - white keys only: rhythm section. Here you will find unique strums and styles, use them for an ending for example.
5. Press C7 and the sound is moved to a higher position. The keys above C7 are not available in this mode.

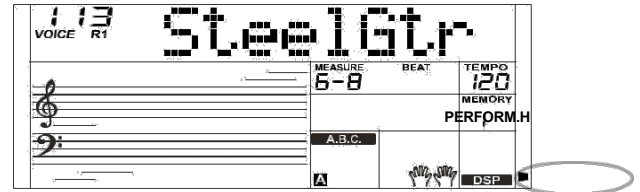

Playing in guitar mode

Play a chord in the 1st range. The chord is shown in the display and you hear the root note.

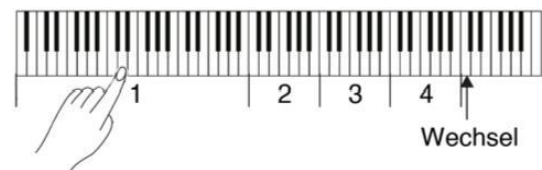

Try different keys in the 2nd range; you will hear different wonderful phrases each time.

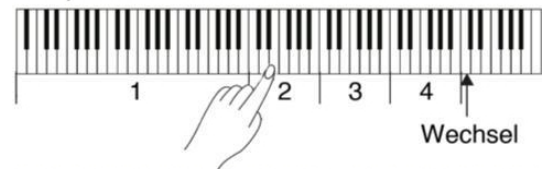

Play a chord with the left hand and a free solo in the 3rd range.

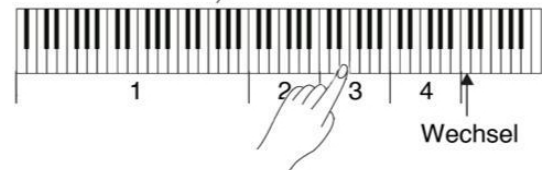

Try an accompaniment in the 4th range (strumming).

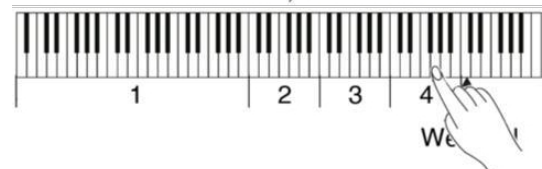

To end your game with an Ending, press the A6 or B6 keys. The accompaniment stops automatically.

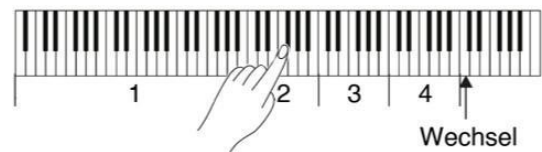

All black keys in areas 1, 2 and 4 are echo keys. There are five types: C#, D#, F#, G#, A#.

Position change: Press C7; "Perform.H" appears in the display. Play the white keys in areas 1, 2 and 4 and hear the new sound.

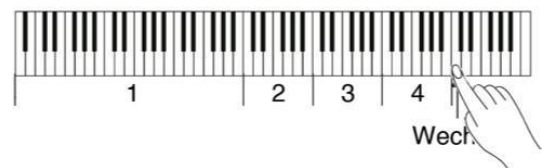

Piano mode

In this mode you can play like on an acoustic piano. Various functions are available for this purpose: Piano Rhythms (5), Broken Chords (5) and three Endings.

The assignment is similar to the guitar mode: press the keys A6 to C7 to play an ending. The black keys above C4 are not assigned in this mode.

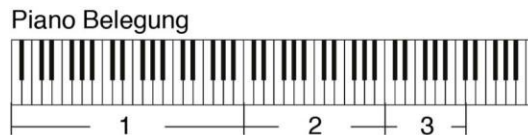

When the keyboard is in assist mode, use the rotary wheel or the +/YES or -/NO keys to switch to piano mode.

Try out the different areas and finish your game with one of the endings.

To exit the assistance function, press one of the following buttons: VOICE, STYLE, SONG, PERFORM.

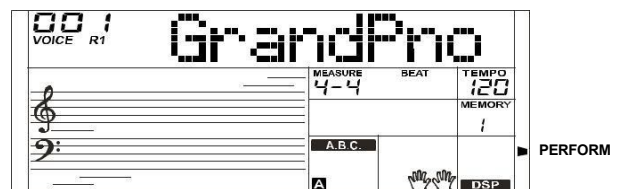

DSP effect

With the help of the built-in digital effects, you can add ambience and depth to your music in a variety of ways. For example, you can add reverb so that the sound is like playing in a large hall, or you can add harmony notes for a fuller sound.

1. When the device is switched on, the DSP effect is active and the indicator light is on.
2. Press the SHIFT and DSP keys to turn off the effect.

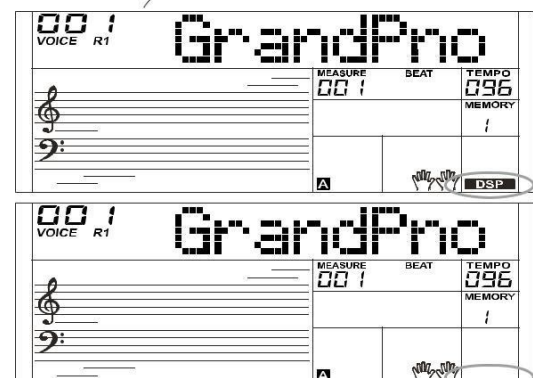
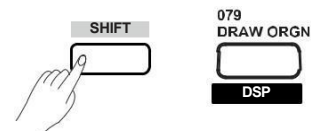

Pedal function

The pedal can be assigned various functions that give your playing more natural expression. You can also find details about this in the chapter "Pedal types".

1. Sustain Pedal (SPd Sust) This pedal function simulates a damper effect of an acoustic piano which makes the notes sound longer.
2. Soft Pedal (SPd Soft) When you press the pedal, all the notes get a softer sound.
3. Style Start/Stop Pedal (SPd St/T) If you assign the function "Pedal St/T" to the pedal, it gets the same function as the START/STOP button.
4. Memory Pedal (SPd Mem) The "Pedal Mem" function loads the next parameter from M1 each time the pedal is pressed. The maximum number is 32.

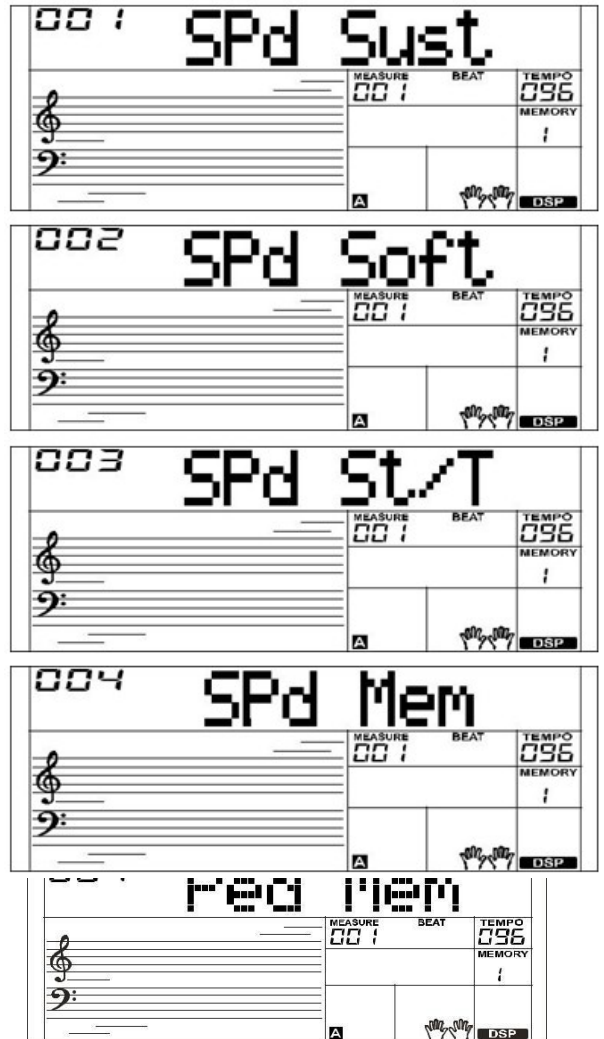

The soft pedal of a unit pedal can be assigned other pedal functions. For details, refer to the Menu function.

1. Pedal Soft (UPd Soft)
2. Pedal St/T (UPd St/T)
3. Pedal Mem (uPd Mem)

Function menu

Press the SHIFT and FUNCTION keys to enter the function menu; the current function appears in the display. Use the rotary knob or the +/YES and -/NO keys to change the parameters. See the following table:

CONTENT	LCD DISPLAY	RANGE	DEFAULT
Tune	XXX Tune	-50...50	0
Beat Type	XXX Beat	0,2...9	4
Split Point	XXX Split Pt	1...88	34
Pedal Type	00X SPd ****	SUST, SOFT, St/T, MEM	SUST (001)
	00X UPd ****	SOFT St/T MEM	Soft (001)
Harmony Type	00X HAR TYPE	Duet, StandardTrio, Full Chord, Rock Duet, Country Duet, Country Trio, Block, 4 Close 1, 4 Close 2, 4 Open, 1+5, Octave1, Octave2, Strum, Echo1, Echo2, Echo3, Echo4, Tremolo1, Tremolo2, Tremolo3, Tremolo4, Trill1, Trill2, Trill3, Trill4	Duet (001)
EQ Type	XXX EQ TYPE	EQ Pop, EQ Rock, EQ Class, EQ Jazz, EQ Dance, EQ Reset	006 EQ Reset
Reverb Type	XXX Rev TYPE	RevRoom1/RevRoom2/RevRoom3/RevHall1/RevHall2/RevHall3/ Rev Chr1/Rev Chr2/Rev Del/Rev PanD	004 RevHall1
Reverb Level	XXX Rev Lev	0 – 127	Current voice
Chorus Type	XXX Chr TYPE	Chorus1/Chorus2/GM Chr1/GMChr2/Flanger1/Flanger2/Rotary1/Rotary2	004 GM chr2
Chorus Level	XXX Chr Lev	0 – 127	Current voice
MIDI Receive	XXX Receive	01—16, ALL	ALL
MIDI Transmit	XXX Transmit	01—16	01
Auto Power Off	XXX POWEROFF	Off,30,60	30

The menu is automatically closed if no entry is made within five seconds.

Tuning

This function allows you to adjust the pitch of the piano. to adapt them to recordings or other Adapt instruments.

1. press the SHIFT and FUNCTION keys until "xxx Tune" appears in the display. With the aid of the rotary knob or the +/YES and -/NO keys can be used to you change the parameter.
2. press the +/YES and -/NO keys simultaneously. sets the setting to the original value 000 back. The setting refers to sound and accompaniment.

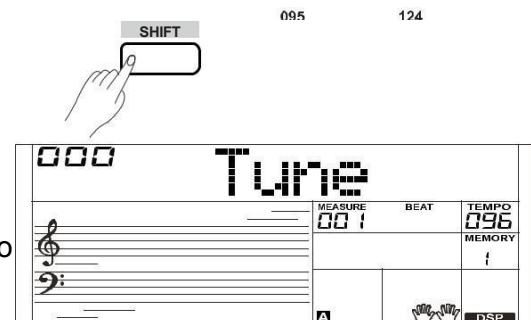

Split function

The splitpoint divides the keyboard into an area for the accompaniment (to the left of the splitpoint) and one for melody playing (to the right of it).

1. Press SHIFT and FUNCTION repeatedly to Select "Splitpoint". The display shows "xxx KeySplit".
2. You can change the value with the rotary wheel or the +/YES and -/NO keys. The range is from 1 to 88. If you press the +/YES and - keys /NO simultaneously, the factory setting is restored (F#3-34).

When Twinova is active, the range is between C3 and C6 (28-64). Press +/YES and -/NO simultaneously to return to the original setting of E3 (32) to be restored.

Time signature

1. Press SHIFT and FUNCTION repeatedly to Select "Beat". xxx BeatType" appears in the display. The value range goes from 2 to 9 and 0, ex works 4 is set.
2. You can change the value with the rotary knob or the +/YES and -/NO keys. If you press the +/YES and -/NO keys simultaneously, the factory setting is restored.

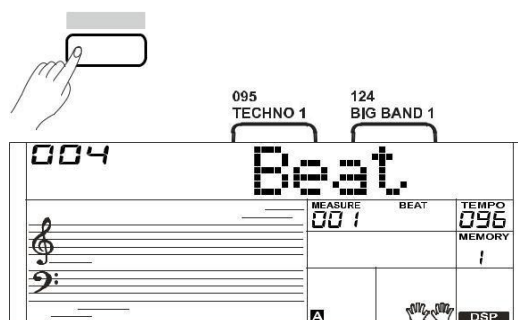
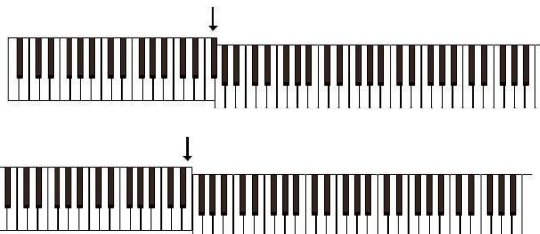
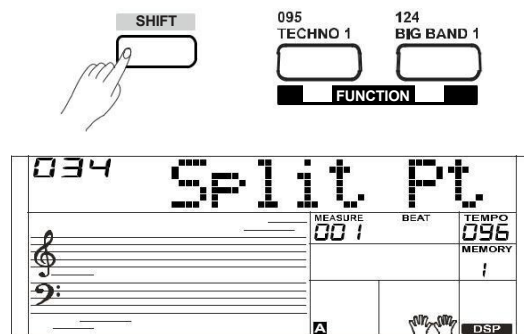

Pedal

1. Press SHIFT and FUNCTION repeatedly to enter the settings; the display will show "00x SPd xxx". You can change the Setting with the rotary knob or the +/YES keys and -/NO. The choices are Sustain, Soft, Auto Accompaniment Start/Stop and Memory Switch. The factory setting is "Sustain".
2. You can choose from four pedal functions. If you press the +/YES and -/NO keys simultaneously, the factory setting is restored.
3. Follow the operation in step 1 to assign functions to the soft pedal of a unit pedal except when the LCD displays "00X UPd xxxx".

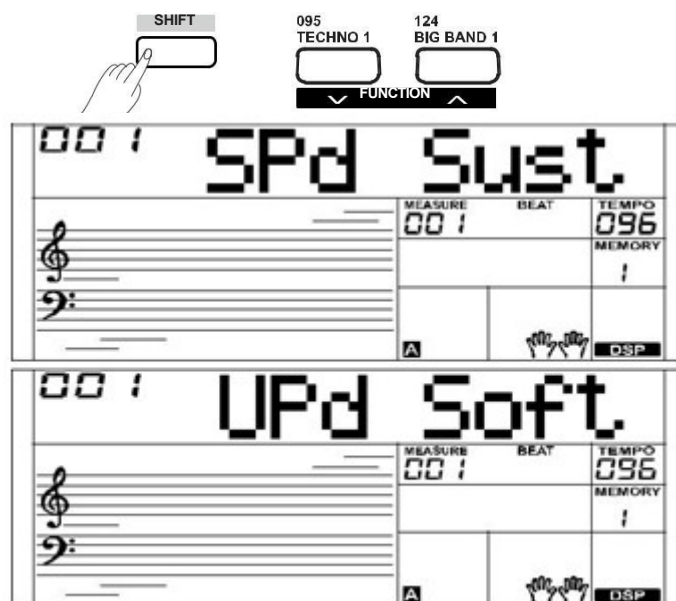

No.	Sustain Pedal (Assignable Functions)	LCD	Soft Pedal (Assignable Functions)	LCD
1	Sustain Pedal	SPd Sust	Soft Pedal	UPd Soft
2	Soft Pedal	SPd Soft	Start/Stop Pedal	UPd St/T
3	Start/Stop Pedal	SPd St/T	Memory Switch Pedal	UPd Mem
4	Memory Switch Pedal	SPd Mem		

EQ - Equalizer

The equalizer is a function that affects the gain spectrum to achieve a special effect. The instrument has six types of equalizer. Hold down the function key and press the desired key in the EQ settings area.

- 1: Pop4 : Jazz
- 2: Rock 5: Dance
- 3: Classic6 : Reset

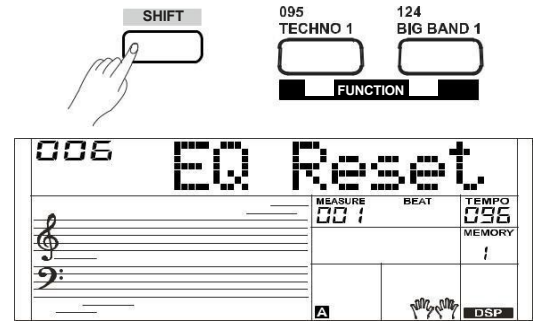

Reverb

1. Press SHIFT and FUNCTION repeatedly to enter the menu. "001 Rev Hall 1" appears in the display.
2. Use the rotary wheel or the keys +/YES and -/NO to change the value.
3. If you press the +/YES and -/NO keys simultaneously, the initial state is restored (004 Rev Hall 1).

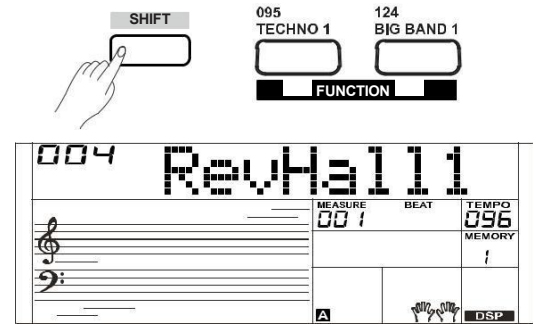

Display indicator type	
1 RevRoom1	Room 1
2 RevRoom2	Room 2
3 RevRoom3	Room 3
4 RevHall1	Hall 1
5 RevHall2	Hall 2
6 RevHall3	Hall 3
7 Rev Chr1	Church 1
8 Rev Chr2	Church 2
9 Rev Del	Delay
10 Rev PanD	Pan Delay

Reverb level

1. Press SHIFT and FUNCTION repeatedly to enter the menu. The display shows "****Rev Lev". The range goes from 0 to 127.
2. Use the rotary wheel or the +/YES and - keys /NO to change the value.
3. If you press the +/YES and -/NO keys simultaneously, the initial state is restored (070).

Chorus

1. Press SHIFT and FUNCTION repeatedly to enter the menu. The factory setting "004 GM Chorus2" appears in the display. There are 8 types to choose from.
2. Use the rotary wheel or the keys +/YES and -/NO to change the value.
3. If you press the +/YES and -/NO keys simultaneously, the initial state is restored.

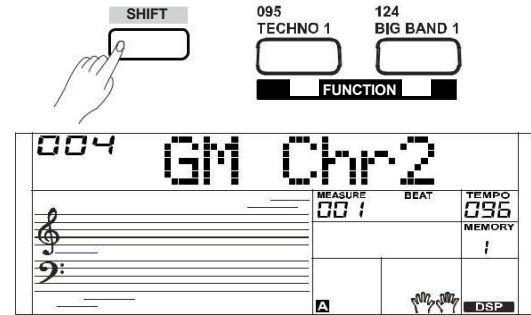

Chorus level

1. press SHIFT and FUNCTION repeatedly to call up the menu. The display shows "xxx Chr Lev". The range goes from 0 to 127.
2. Use the rotary wheel or the keys +/YES and -/NO to change the value.
3. If you press the +/YES and -/NO keys simultaneously Press the key to return to the initial state (000).

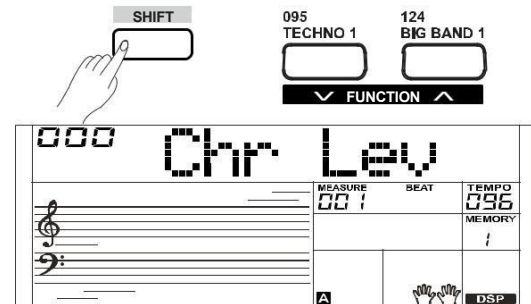

Display	Type
1 Chorus1	Chorus 1
2 Chorus2	Chorus 2
3 GM Chr1	GM CHorus 1
4 GM Chr2	GM Chorus 2
5 Flanger1	Flanger 1
6 Flanger2	Flanger 2
7 Rotary1	Rotary 1
8 Rotary2	Rotary 2

Harmony Art

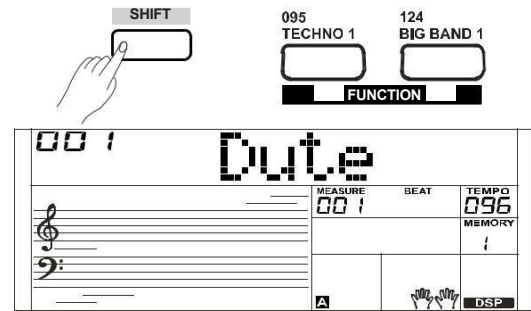

1. Press the SHIFT and FUNCTION keys repeatedly to access the settings; the factory setting "001 Duet" appears in the display. The available harmonies can be found in the adjacent table.
2. Pressing the +/YES and -/NO keys simultaneously restores the factory setting.
3. With the harmony types echo, tremolo or trill, the effect can be further adjusted. Please read more about this in the next chapter.

If the harmony type is strum, echo, trill or tremolo, the tempo setting will affect the effect.

No.	LCD	Harmony Type
1	Duet	Duet
2	STD Trio	Standard trio
3	FulChord	Full Chord
4	RockDuet	Rock Duet
5	CtryDuet	Country Duet
6	CtryTrio	Country trio
7	Block	Block
8	4Close1	4 Close 1
9	4Close2	4 Close 2
10	4 Open	4 Open
11	1+5	1+5
12	Octave1	Octave 1
13	Octave2	Octave 2
14	Strum	Arpeggio
15	Echo1	Echo1
16	Echo2	Echo2
17	Echo3	Echo3
18	Echo4	Echo4
19	Tremolo1	Tremolo1
20	Tremolo2	Tremolo2
21	Tremolo3	Tremolo3
22	Tremolo4	Tremolo4
23	Trill1	Trill1
24	Trill2	Trill2
25	Trill3	Trill3
26	Trill4	Trill4

MIDI In

1. Press SHIFT and FUNCTION to enter the menu. The display shows "xxx Midi In". The range is from 1 to 16; ALL.
2. Use the rotary wheel or the +/YES and -/NO keys to change the midi channels.
3. If you press the +/YES and -/NO keys simultaneously, the initial state (ALL) will be restored.

MIDI Out

1. Press SHIFT and FUNCTION to enter the menu. The display shows "xxx Midi Out". The range is from 1 to 16.
2. Use the rotary wheel or the keys +/YES and -/NO to change the value.
3. If you press the buttons +/YES and -/NO keys at the same time, the output state is (001) restored.

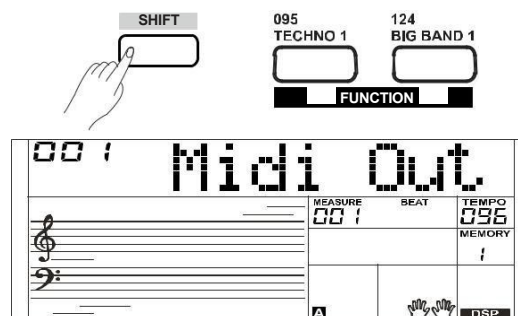

Switch off

With this function you can define after which time the device should switch off automatically.

1. Press SHIFT and FUNCTION to call up the menu. "xxx PowerOff" appears in the display. Possible settings are 0, 30 and 60 min.
2. Use the rotary wheel or the keys +/YES and -/NO to change the value.
3. If you press the buttons +/YES and -/NO keys at the same time, the output state is (030) is restored.

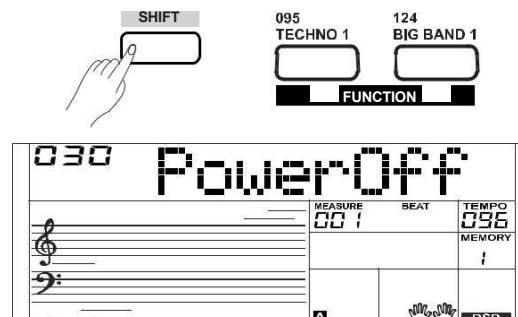

Registration memory

This keyboard is an instrument with a wide range of functions and settings. The Registration Memory function allows you to save all the settings you have made and recall them with a single button press.

Settings

1. There are 8 memories (memory banks) with each 6 memory locations (M1 to M6).
2. Press and hold the STORE button and press one of the memory buttons M1 to M6. Please note that this will overwrite the previous settings.
3. you can delete memory locations by pressing and holding the STORE and M1 keys when you turn on the device.

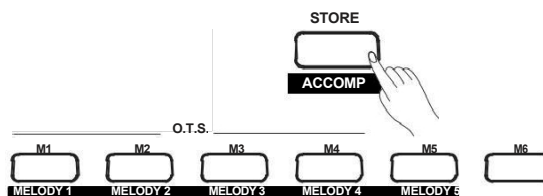

Calling up the settings

Press one of the memory buttons M1 to M6. In the example opposite, the settings from memory 1 of the 1st memory bank are called up.

When the One Touch Setting function is active, no information can be retrieved from memory.

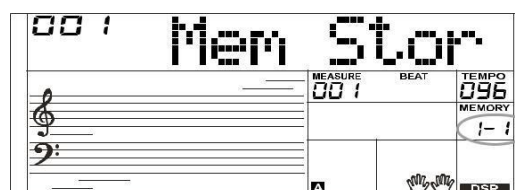
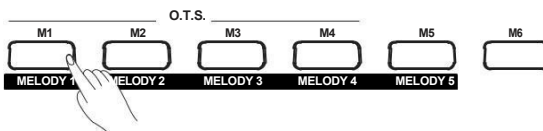

Selection of the memory location

1. Press BANK; the number of the memory appears in the display.
2. Select one of the eight memories using the rotary knob or the +/YES or -/NO keys.

The following parameters can be saved: Sound: Voice, Dual, Lower, DSP, Mixer
 Accompaniment: style, tempo, chord mode on/off, etc.
 Functions: Touch, as well as the parameters in the function menu

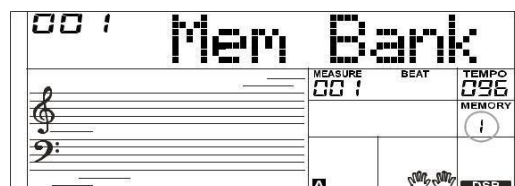
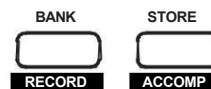

Recording

With the easy-to-use recording function you can record your own playing, a so-called user song. You can record 5 such user songs, each with 6 tracks: one accompaniment track (Accomp) and five melody tracks (Melody).

You can record an accompaniment track and a melody track simultaneously, but not two melody tracks. Of course, you can also record all tracks individually and play them back together. The recording remains saved even if you switch off the device.

Starting the recording

1. Press SHIFT and RECORD to enter the song selection mode. "RecSong1" appears in the display. Use the rotary knob or the +/YES and -/NO keys to select the song you want to record.
2. Press SHIFT and FUNCTION again to enter the preparation mode. The "Rec" indicator lamp lights up and the flashing indicates the beat. The keyboard selects independently the next free memory location.
3. You can now set parameters such as Voice, Style and check tempo. When you record a new song, the keyboard automatically selects "Melody 1" as the song to be recorded. Track off. Simply press another track button (Accomp or Melody) if you want to record another track. A Style can be recorded only in the accompaniment track.
4. Press START/STOP or start playing to start recording. If the auto accompaniment is active, a left hand chord will also start the recording.

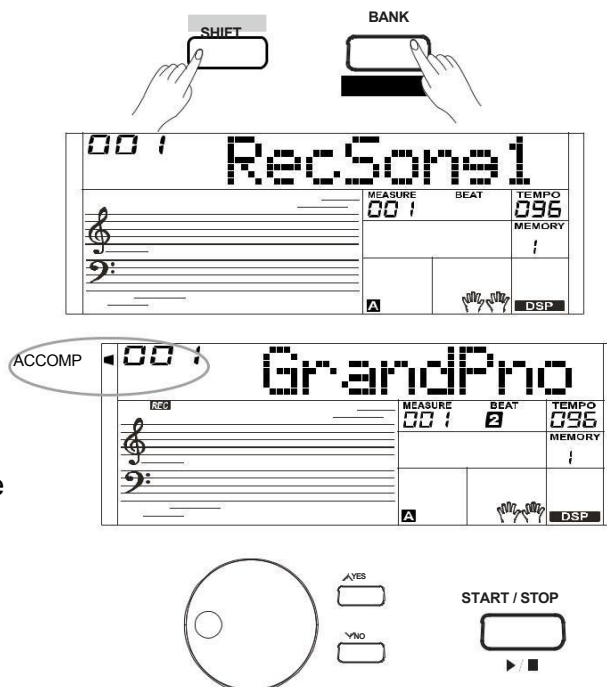

The track has an indicator light that shows the respective status.

- The flashing means that the track has been selected for recording. If there is already data on it, it will be deleted.
- The glow of the lamp indicates that there is data on it that will be played back simultaneously with the recording (playback).
- If the lamp is off, there is either no data on it or the data is not suitable for playback.

If all six tracks are occupied and a new MELODY5 to be recorded, simply select it and start recording. The Track is thereby deleted and occupied with new content.

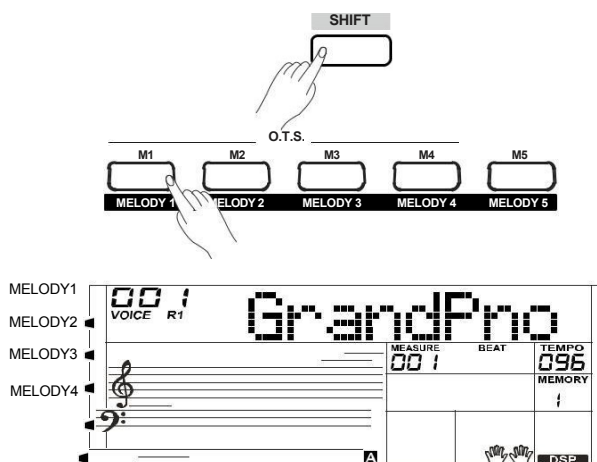

Stop recording

1. Press the SHIFT and RECORD keys to stop recording.
2. When the memory space is exhausted, "Rec_Full" appears in the display. The exposure is canceled and saved.
3. When you record an accompaniment, recording stops automatically at the end of the song.

Playback

1. During a recording, press the SHIFT and RECORD keys. The recording is stopped, the device changes to MELODY1 ^{SONG} mode and the recording is played back continuously.
2. Press SONG to enter the song mode. All songs will be played continuously. Use the rotary knob or the +/YES and -/NO keys to select a song. There are 70 songs in total; the user songs are located from 61 to 70. If there are no songs, "NoFile" appears in the display.
3. Press PLAY/STOP to play the song continuously.

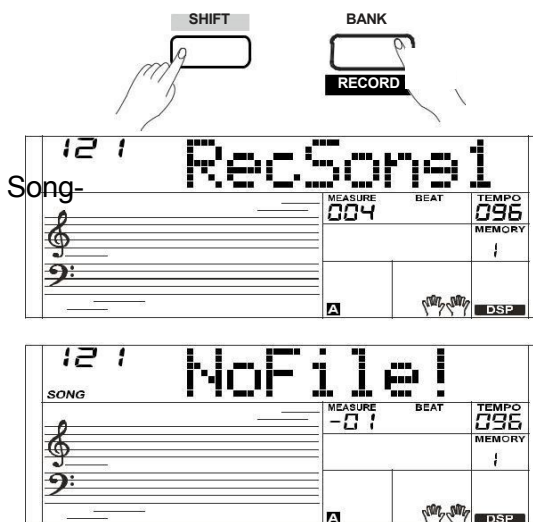

Delete a song

1. When you press the RECORD and SONG buttons while you switch on the device, the device will be deleted all existing data.
2. In preparation mode, hold RECORD for 2 seconds; the display shows "Delete?" (delete?).
3. Select the track you want to delete while holding down the SHIFT key. Press +/YES to delete the song or -/NO to cancel the action.

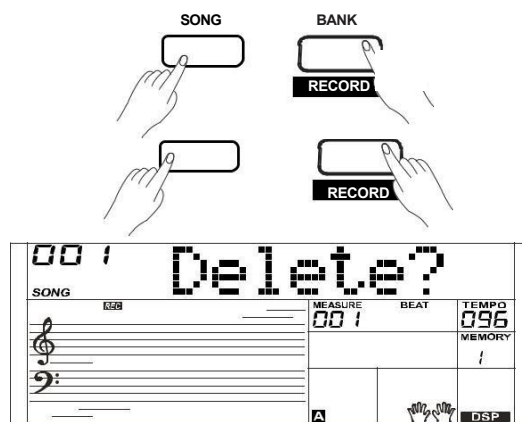

Song

The keyboard has a total of 120 songs. You can practice all songs with the melody track turned off.

Listen to the songs

1. Press SONG. All songs are played in turn.
2. Select a song by using the rotary wheel or the +/YES and -/NO buttons.
3. If you want to play a song repeatedly, press the START/STOP button.
4. When the song is finished and you want to exit the song mode, press one of the STYLE or VOICE buttons.

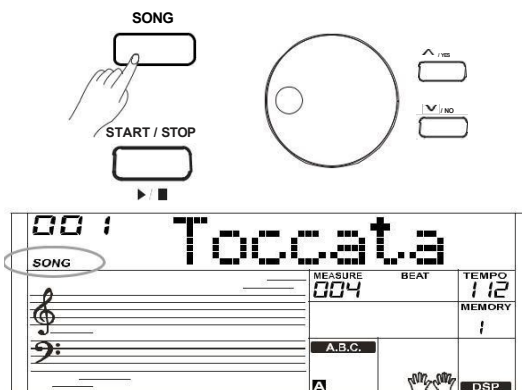

Song settings

1. A song starts with a count-in and thus with a negative bar number. The song starts as soon as the bar number reaches 1.
2. While the song is playing, you can use the FF key to fast "fast forward" the song, REW to "rewind" the song, and PAUSE to pause the song.
3. Press REPEAT to repeat the song. It will be played continuously.

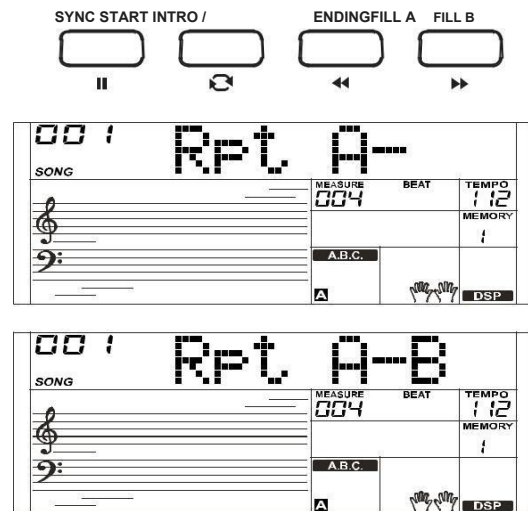

Learning mode

The following keys are activated in the learning mode: LESSON, LEFT, RIGHT. These also work only in learn mode.

1. Press SHIFT and LESSON to activate the mode. Ex works the mode for the right hand is activated (RIGHT). Press LEFT to switch to left hand mode. Press both keys simultaneously to practice two-handed. Press START/STOP or SONG to start the learning mode.
2. While the learning mode is active, the system cannot be changed. The rating is done automatically at the end of the song.
3. Not every song can have ambidextrous learning enabled.
4. The display shows the chords.

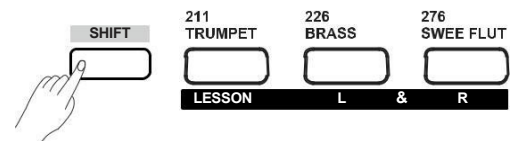

Lesson 1

Press SHIFT and LESSON to activate the learning mode. The indicator lamp lights up. In this mode, the system evaluates timing only, not pitch or chords. If you press RIGHT, the right part is muted and you practice playing with the right hand. If you press LEFT, you can practice playing with the left hand. If you press both keys, you can practice two-handed. Press START/STOP to start, the evaluation will be done automatically at the end of the song.

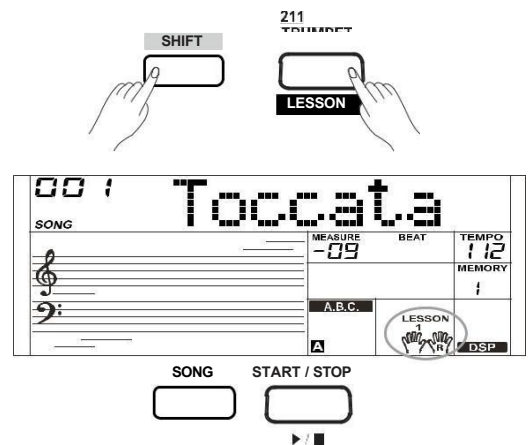

Lesson 2

Press SHIFT and LESSON to activate the learning mode. The control lamp lights up. In this mode, the system evaluates only the pitch. If you play a wrong note, no sound will be heard. The system waits until you play the note correctly. If you press RIGHT, the right part will be muted and you will practice playing with the right

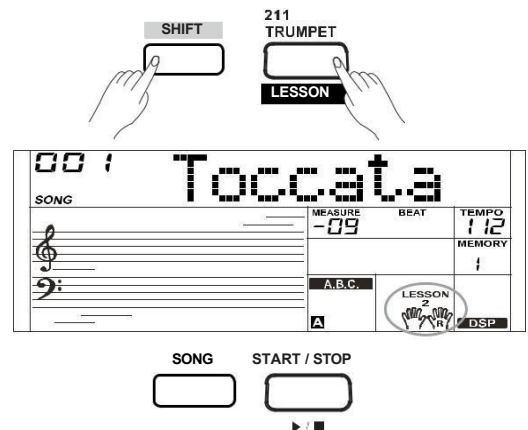

hand. If you press LEFT, you can practice with your left hand. If you press both keys, you can practice with both hands. Press START/STOP to start, the evaluation will be done automatically at the end of the song.

Lesson 3

Press SHIFT and LESSON to activate the learning mode. The indicator lamp lights up. In this mode, the system evaluates both timing and pitch. If you press RIGHT, the right part is muted and you practice playing with the right hand. If you press LEFT, you can practice playing with the left hand. Press both keys, you can practice ambidextrous. Press and hold SHIFT and LESSON to start, you will hear what you play, whether right or wrong. The score is automatically at the end of the song.

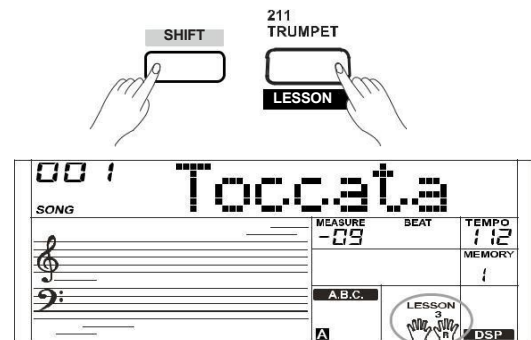

Chord Dictionary - Chord Dictionary

This is a built-in reference book where you can look up chords.

Chord learning mode

Press SHIFT and DICT for longer than 2 seconds to enter Dict-1 mode. Auto Accompaniment is automatically activated in this mode.

In this mode, the keys above C4 are used to assign the chord type (Chord Type), the keys above C6 to assign the root (Chord Root). So to display a chord, first select the root, then the type of chord.

When the chord and root are confirmed, the display shows the chord and its position on the keyboard. It will sound immediately if you play it correctly in the chord area of the keyboard.

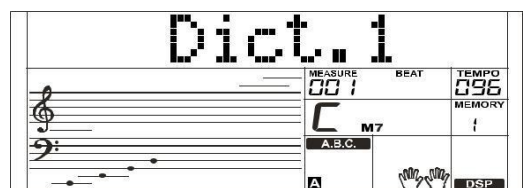
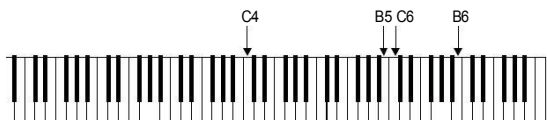
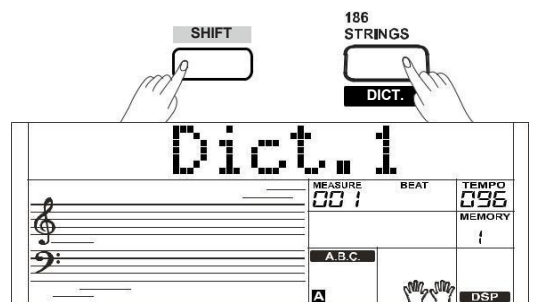

Exam mode

Press the SHIFT and DICT keys again to enter the Dict-2 mode. This is the exam mode. A random chord is shown in the display, while no keyboard position is added to it. is displayed. If you select the correct chord

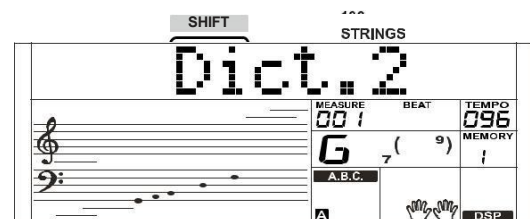

play within 3 seconds, the next chord is displayed. If not, the display will automatically show the correct position. To exit the Chord Dictionary, press CHORD DICT again. Below you will see an overview of 24 chords:

Note	Chord Root	Note	Chord Type	Note	Chord Type
C6	C	C4	M	C5	7(b9)
C#6	C#/Db	C#4	M(9)	C#5	7(9)
D6	D	D4	6	D5	7(#9)
Eb6	Eb/D#	Eb4	mM7	Eb5	7(b13)
E6	E	E4	M7	E5	7(13)
F6	F	F4	M	F5	7(#11)
F#6	F#/Gb	F#4	M(9)	F#5	dim7
G6	G	G4	M6	G5	dim
Ab6	Ab/G#	Ab4	M7(9)	Ab5	7aug
A6	A	A4	M7	A5	aug
Bb6	Bb/A#	Bb4	M7b5	Bb5	7sus4

USB drive

The keyboard has an interface that supports the USB disk (16M-32G). It is compatible with the FAT 16/32 system format, but it is better to use the USB disk formatted by the keyboard. Please do not modify this data from the keyboard with a PC.

Basic operation

B6	B	B4	7	B5	START / STOP	SUS4
----	---	----	---	----	--------------	------



- In U-Disk mode you can use the following keys: USB-DEVICE, +/YES, -/NO, DATA and START/STOP.
- Press USB DEVICE to enter the U-Disk mode. press again to exit the mode.
- The display will show "Wait...!" (wait) while the keyboard tries to establish a connection to the U-Disk. If the connection is established, "play" appears in the display. If no connection can be established, the error message "DiskErr!" appears. If the keyboard cannot find a U-Disk, it reports "No Disk!".
- In U-Disk mode, you can select a menu using the rotary wheel, move to the next menu using the +/YES key, and press /NO to move to the go back to the previous menu.
- If a MIDI file is detected and selected on the U-Disk, it will be shown in the display together with its name. Otherwise, submenus with the character "DIR" appear. The names of the files appear alphabetically, but you can only select the first 512 files. During data is being saved, loaded or deleted, the display shows "Wait...!". During this time

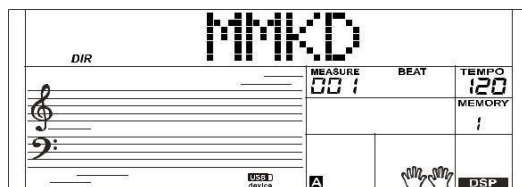
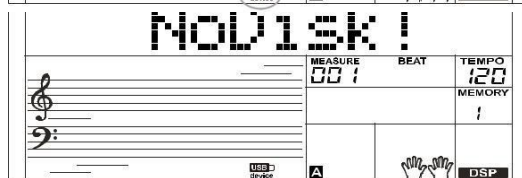
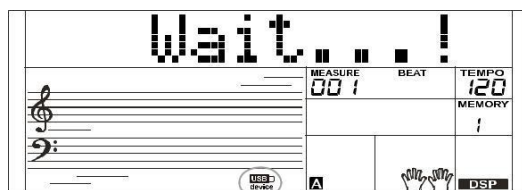

the keys do not work. You can exit the U-Disk mode with the STYLE, SONG or USB-Device keys.

6. While a MIDI file is playing, you can press the MIXER button to adjust the volume (0-127).
7. Please note that you can only edit files in the "MMKD" directory.
8. The directory "MMKD" is automatically generated during the first saving.

Note: The "MMKD" folder is automatically generated when user data is saved to the USB storage device.

Playing MIDI files

1. Press USB DEVICE to enter the U-Disk mode. "Play" appears in the display.
2. Press +/YES; the display shows MIDI and the submenu.
3. When you select a submenu, its name appears in the display and the indicator lamp lights up. Press +/YES to enter the menu.
4. Select a file with the rotary wheel and press START/STOP to play it continuously. Press again to stop the playback.
5. Press +/YES to exit the menu; "... " appears in the display.

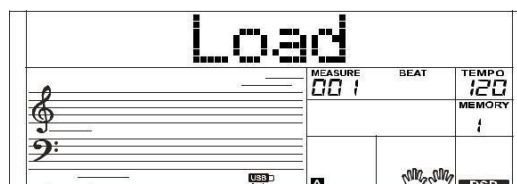
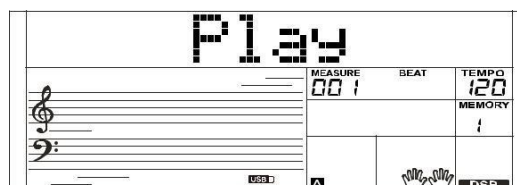

Store

Press USB DEVICE, select "Load" with the rotary wheel and press +/YES.

Loading a song

1. Select "LoadSong" and press +/YES. The MIDI files appear in the display. Use the rotary wheel or the +/YES and -/NO keys to select one of them.
2. Press +/YES to confirm your selection. The number of the user song appears in the display. Use the rotary wheel to select one of them.
3. Press +/YES to confirm your selection. "Sure?" appears in the display. Press +/YES if you are sure you want to execute the command. If you want to cancel the operation, press -/NO.

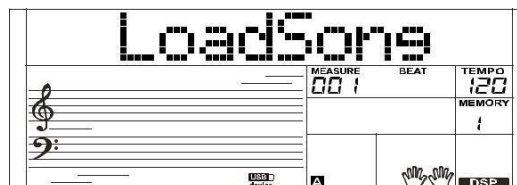

Loading a style

1. Select "LoadSty" and press +/YES. The MIDI files appear in the display. Use the rotary wheel or the +/YES and -/NO keys to select one of them.
2. Press +/YES to confirm your selection. The number of the user song appears in the display. Use the rotary wheel to select one of them select.
3. Press +/YES to confirm your selection. "Sure?" appears in the display. Press +/YES if you are sure you want to execute the command. If you want to cancel the operation, press -/NO.

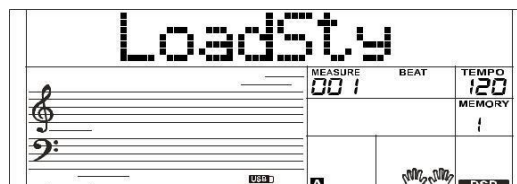

Loading settings

1. Select "LoadMem" and press +/YES. The MIDI files appear in the display. Use the rotary wheel or the +/YES and -/NO keys to select one of them.
2. Press +/YES to confirm your selection. The number of the user song appears in the display. Use the rotary wheel to select one of them.
3. Press +/YES to confirm your selection. "Sure?" appears in the display. Press +/YES if you are sure you want to execute the command. If you want to cancel the operation, press -/NO.

Backing up data to the U-Disk

1. Press USB DEVICE and select the "Save" menu with the rotary wheel. Press +/YES; the submenus appear in the display: "SaveSong", "SaveSty", "SaveMem" and "SaveVoic". Use the rotary wheel to select one of them.
2. Make your selection and press +/YES. If no file is present, the display reports "NoFile!" and returns to the previous menu after 2 seconds. However, you can also enter a file name. The name may consist of 8 capital letters.
3. When you are finished with your input, press +/YES to save the file. "Sure?" appears in the display. Press +/YES if you are sure you want to execute the command or -/NO if you want to cancel the operation. If the file name already exists, the display will show "SameName".

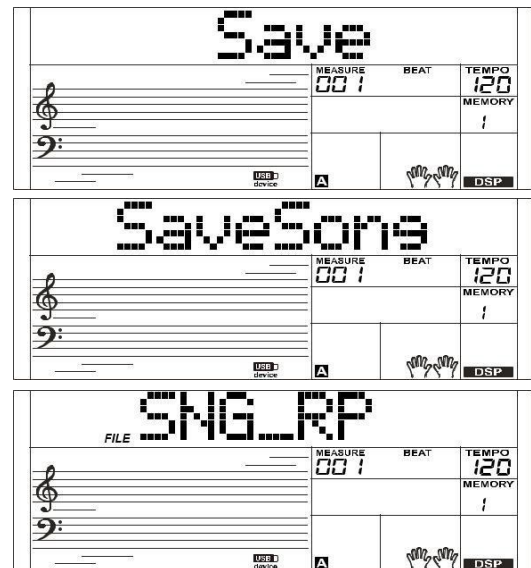

Deleting data on the U-Disk

1. Press USB Device, select the "Delete" menu with the rotary wheel and press +/YES; the submenus appear in the display: "UserSong", "UserSty", "UserMem" and "UserVoic". Use the rotary wheel to select one of them.
2. Make your selection and press +/YES. If no file is present, the display reports "NoFile!" and returns to the previous menu after 2 seconds.
3. Press +/YES to delete the file. "Sure?" appears in the display. Press +/YES if you are sure you want to delete the file.

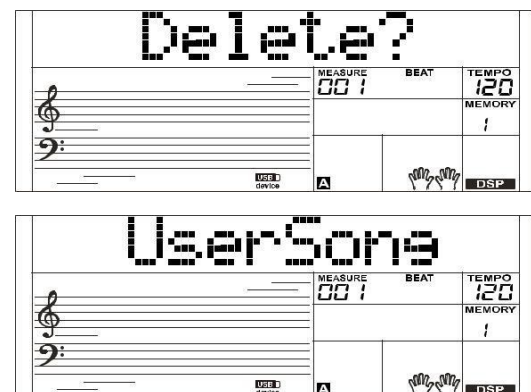

Formatting the U-Disk

Press USB DEVISE, select the menu "Format" and press E+/YES. Sure?" appears in the display. Press +/YES if you are sure you want to execute the command.

Formatting will delete all data in the USB section.

Notice:

Formatting will delete all user data in the USB storage device!

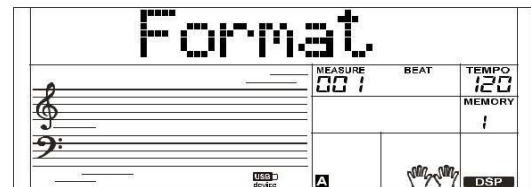

Keys / letters overview

NOTE	C#2	D2	Eb2	E2	F2	F#2	G2	Ab2	A2	Bb2	B2
LETTER	DEL	BACK	NEXT	A	B	C	D	E	F	G	H
NOTE	C3	C#3	D3	Eb3	E3	F3	F#3	G3	Ab3	A3	Bb3
LETTER	I	J	K	L	M	N	O	P	Q	R	S
NOTE	B3	C4	C#4	D4	Eb4	E4	F4	F#4	G4	Ab4	A4
LETTER	T	U	V	W	X	Y	Z	0	1	2	3
NOTE	Bb4	B4	C5	C#5	D5	Eb5					
LETTER	4	5	6	7	8	9					

MIDI

MIDI functions allow you to expand your musical possibilities. This section explains what MIDI is, what it can do, and how you can use these functions on your instrument.

What is MIDI?

MIDI (Musical Instrument Digital Interface) is a worldwide standard for communication between electronic musical instruments and computers. Exchanging information between devices can create systems of MIDI instruments and drives that are more versatile and flexible than isolated instruments. You can connect computers, sequencers, expanders or other keyboards with your keyboard. MIDI signals can be used in can be divided into two groups: Channel signals and System signals. The Pino has a USB port that can be used for both MIDI In and MIDI Out.

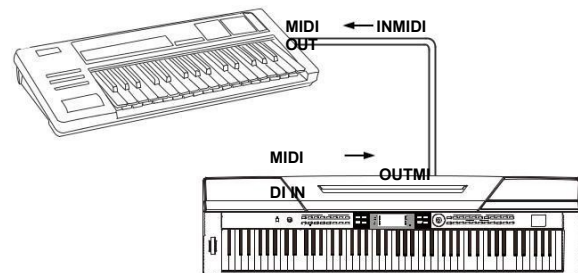

MIDI devices

To exchange MIDI signals, the devices must be connected with a cable. **MIDI IN** receives data from a computer, **MIDI Out** sends data to another device. Please wake up the computer from hibernation or a stand-by mode before you use it to

wire the keyboard. Please switch on the keyboard first **after the** cable connection has been made.

Data exchange with the computer

1. Connect the USB socket on the back of your instrument to a computer using a standard USB cable.
2. Turn on the instrument, then open the "PC Suite" software on your computer; the display will show "PCLink".
3. You can send MIDI files to the keyboard as user Transfer songs. You can also transfer styles, Transfer voices or memory files to the computer.
4. For more detailed information, please read the operating instructions of the software.

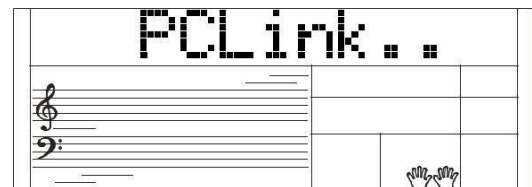
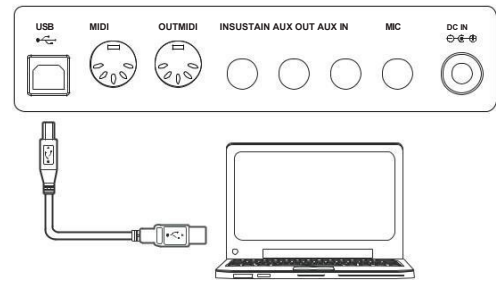

Restore factory settings

When you switch on the device, if you press the keys +/YES and -/NO are pressed, all settings are reset and user styles, user songs and the memories are deleted. "Loading" appears in the display. Once the deletion and factory reset are complete, the unit will start up as usual.

Erasing the memories

Keep the STORE and M1 keys pressed while you switch on the device. All memory locations will be deleted!

Delete the user songs

Press and hold the SONG and RECORD buttons while turning on the power. All user songs will be deleted!

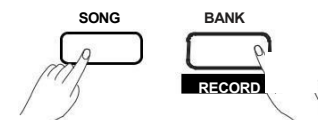
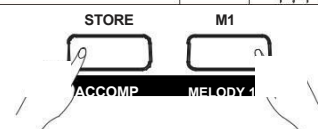
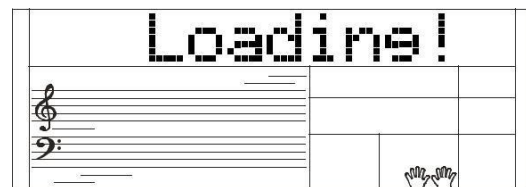
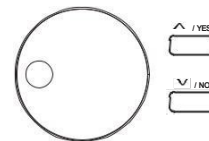

Help with malfunctions

Problem	Possible cause and solution
You hear a "pop" when the device is turned on. or is switched off.	This is normal and not a cause for concern.
You hear nothing when on the keyboard is played.	Possibly the volume is too low adjusted. Turn it up a little further. Check if headphones are connected is. Check that the R1/R2/L Voice controls are set appropriately.
Noises occur during the Use of a cell phone on.	A cell phone near the instrument can cause interference. Switch off the phone off or move a little further away from the Device.
The auto accompaniment does not start although it is in stand-by mode.	Try to set the auto accompaniment in the range of the right hand to start. To start them synchronously start, you must press a key in the area of the left hand press.
Certain notes sound wrong.	Check that the Tune value is set to 0. You can reset the instrument to the factory settings reset by pressing the +/YES and -/ keys. NO while holding down the keyboard turn on
The harmony function does not work.	When a drum kit is selected as Voice R1, the function is not available.
After a connection with a Computer the keyboard will not recognized.	Check if the USB cable is neatly is connected and try if necessary, the keyboard to another USB port to connect.

Specifications

LCD display	Multifunctional display
Keys	88, hammer action
Polyphony	128
Voices	600
Styles	230 + 10 user styles
Songs	120 + 5 user songs
Demo	5
Controller	POWER SWITCH, VOLUME, PERFORM., METRONOME, SHIFT, STYLE DIRECT BUTTON1~8, PITCH BEND, FUNCTION -, FUNCTION +, HARMONY, TRANSPOSE-, TRANSPOSE +, PIANO, VOICE, STYLE, DEMO, SONG, +/YES, -/NO, DATA DIAL, DUAL, LOWER, DSP, TOUCH, VOICE DIRECT BUTTON 1~10, SUSTAIN, DICT., LESSON, LESSON L, LESSON R, BANK, STORE, M1~M6, O.T.S, USB DEVICE, TWINOVA, OCTAVE
Automatic accompaniment controller	START/STOP, SYNC START, INTRO/ENDING, FILL A, FILL B, MIXER -, MIXER +, Chord Mode, FADE, ACCOMP -, ACCOMP +.
Recording	Record, Accomp Track, Melody Track 1-5
Memory	48
Connections	DC IN, 2x Headphones, Sustain Pedal, unit PedalAUX IN, AUX OUT, USB-MIDI
Power supply	12 V, 2000 mA
Loudspeaker	2 x 4 Ω , 20 W 2 x 8 Ω , 010 W
Dimensions W x D x H	1510 x 480 x 230 mm
Weight	13,8 kg
All specifications are subject to change without notice.	

Sounds overview

NO.	English Name	LCD Name
Piano		
1	Acoustic Grand Piano	GrandPno
2	Acoustic Grand Piano 2	GrandPn2
3	Acoustic Grand Piano 3	GrandPn3
4	Acoustic Grand Piano (wide)	GrandPnW
5	Acoustic Grand Piano (dark)	GrandPnD
6	Bright Acoustic Piano	BritePno
7	Bright Acoustic Piano 2	BritePn2
8	Bright Acoustic Piano 3	BritePn3
9	Bright Acoustic Piano (wide)	BritePnW
10	Electric Grand Piano	E.Grand
11	Electric Grand Piano 2	E.Grand2
12	Electric Grand Piano (wide)	E.GrandW
13	Electric Grand Piano (dark)	E.GrandD
14	Honky Tonk Piano	HnkyTonk
15	Honky Tonk Piano 2	HnyTonk2
16	Honky Tonk Piano (wide)	HnyTonkW
17	Honky Tonk Piano (dark)	HnyTonkD
18	Harpsichord	Harpsi
19	Harpsichord 2	Harpsi2
20	Harpsichord (octave mix)	HarpsiO
21	Harpsichord (wide)	HarpsiW
22	Harpsichord (with key off)	HarpsiOf
23	Octave Grand Piano	OctPno
24	Octave Grand Piano 2	OctPno2
25	Piano & Strings	Pno&Str
26	Piano & Pad	Pno&Pad
27	Piano & Choir	Pno&Cho
28	Piano & EP	Pno&EP
29	Piano & Vibraphone	Pno&Vib
30	Detuned Electric Piano	DetunEP
31	Detuned Electric Piano 2	DetunEP2
32	Electric piano	E.Piano
33	Electric Piano 2	E.Piano2
34	Electric piano 3	E.Piano3
35	Electric piano 4	E.Piano4
36	Electric Piano 1 (velocity mix)	E.PnoV1
37	Electric Piano 2 (velocity mix)	E.PnoV2
38	60's Electric Piano	60'sEP
39	EP Legend	EPLegend
40	Phase EP	PhaseEP
41	Clavi	Clavi
42	Clavi 2	Clavi2
43	Clavi phase	PhaseClv
44	Wah Clavi	WahClv
45	Pulse Clavi	PluseClv
46	Dream EP	DreamEP
47	Tremolo EP	TremoEP
48	Funk EP	FunkEP
49	Warm EP	WarmEP
50	Choir EP	ChoriEP
51	Wah EP	WahEP
52	Modern EP	ModernEP
53	EP Pad	EPPad

Chromatic Percussion		
54	Celesta	Celesta
55	Celesta 2	Celesta2
56	Celesta 3	Celesta3
57	Glockenspie	Bells
58	Chimes 2	Bells2
59	Music Box	MusicBox
60	Music Box 2	MuscBox2
61	Music Box 3	MuscBox3
62	Vibraphone	Vibra
63	Vibraphone 2	Vibra2
64	Vibraphone (wide)	VibraW
65	Marimba	Marimba
66	Marimba 2	Marimba2
67	Marimba (wide)	MarimbaW
68	Xylophones	Xylophone
69	Xylophone 2	Xylopho2
70	Xylophone 3	Xylopho3
71	Tubular Bells	TubulBel
72	Tubular Bells 2	TubulBe2
73	Church Bell	ChurBell
74	Carillon	Carillon
75	Dulcimer	Dulcimer
76	Dulcimer 2	Dulcime2
77	Santur	Santur
Organ		
78	Italian 60's Organ	60'sOrgn
79	Drawbar Organ	DrawOrgn
80	Drawbar Organ 2	DrawOrg2
81	Detuned Drawbar Organ	DeDraOrg
82	Drawbar Organ 3	DrawOrg3
83	Detuned Percussive Organ	DePerOrg
84	Percussive organ	PercOrgn
85	Percussive Organ 2	PercOrg2
86	70's Percussive Organ	70'sPcOr
87	Percussive organ 3	PercOrg3
88	Rock Organ	RockOrgn
89	Rock Organ 2	RockOrg2
90	Rock Organ 3	RockOrg3
91	Church Organ	ChurOrgn
92	Church Organ 2	ChurOrg2
93	Church Organ 3	ChurOrg3
94	Church Organ (octave mix)	ChurOrgO
95	Detuned Church Organ	DeChuOrg
96	Reed organ	ReedOrgn
97	Reed Organ 2	ReedOrg2
98	Rotary Organ	RotyOrgn
99	Puff organ	PuffOrgn
100	Accordion	Acordion
101	Accordion 2	Acordin2
102	Accordion 3	Acordin3
103	Harmonica	Harmnica
104	Harmonica 2	Harmnic2
105	Harmonica 3	Harmnic3

106	Tango Accordion	TangoAcid
107	Tango Accordion 2	TangoAcid2
Guitar		
108	Acoustic Guitar (nylon)	NylonGtr
109	Acoustic Guitar (nylon) 2	NylonGt2
110	Acoustic Guitar (nylon) 3	NylonGt3
111	Acoustic Guitar (nylon + key off)	NylGtrOf
112	Ukulele	Ukulele
113	Acoustic Guitar (steel)	SteelGtr
114	Acoustic Guitar (steel) 2	SteelGt2
115	12 Strings Guitar	12StrGtr
116	Mandolin	Mandolin
117	Mandolin 2	Mandoli2
118	Steel Guitar with Body Sound	SteelBdy
119	Electric Guitar (jazz)	JazzGtr
120	Electric Guitar (jazz) 2	JazzGtr2
121	Electric Guitar (pedal steel)	PedalGtr
122	Electric Guitar (clean)	CleanGtr
123	Electric Guitar (clean) 2	CleanGt2
124	Electric Guitar (detuned clean)	DetClnGt
125	Mid Tone Guitar	MidTonGt
126	Electric Guitar (muted)	MutedGtr
127	Electric Guitar (muted) 2	MutedGt2
128	Electric Guitar (funky cutting)	FunkGt
129	Electric Guitar (muted velo-sw)	MutVelGt
130	Jazz Man	JazzMan
131	Overdriven Guitar	Ovrdrive
132	Overdriven Guitar 2	Ovrdriv2
133	Guitar Pinch	GtPinch
134	Distortion Guitar	DistGtr
135	Distortion Guitar 2	DistGtr2
136	Distortion Guitar (with feedback)	FeedbkGt
137	Guitar Feedback	GtrFedbk
138	Distorted Rhythm Guitar	DistRyth
139	Guitar Harmonics	GtrHarmo
140	Guitar Harmonics 2	GtHarmo2
141	Velocity Nylon Guitar	NylnGtVe
Bass		
142	Acoustic Bass	AcoBass
143	Acoustic Bass 2	AcoBass2
144	Wah Bass	WahBass
145	Electric Bass (finger)	FngrBass
146	Finger Slap Bass	FngrSlap
147	Electric Bass (pick)	PickBass
148	Electric Bass (pick) 2	PickBas2
149	Fretless bass	Fretless
150	Fretless Bass 2	Fretles2
151	Slap bass	SlapBass
152	Slap Bass 2	SlapBas2
153	Slap Bass 3	SlapBas3
154	Slap Bass 4	SlapBas4
155	Synth bass	SynBass
156	Synth Bass 2	SynBass2
157	Synth Bass 3	SynBass3

158	Synth Bass 4	SynBass4
159	Warm synth bass	WarmBass
160	Rsonance SynBass	ResoBass
161	Clavi bass	ClavBass
162	Hammer	Hammer
163	Attack bass	AttackBas
164	Synth Bass (rubber)	RubbBass
165	Synth Bass (rubber) 2	RubbBas2
166	Attack Pulse	AtackPls
Strings & Orchestral		
167	Violin	Violin
168	Violin 2	Violin2
169	Violin (slow attack)	SIViolin
170	Viola	Viola
171	Viola 2	Viola2
172	Cello	Cello
173	Cello 2	Cello2
174	Contrabass	Contrabs
175	Contrabass 2	Contrbs2
176	Tremolo Strings	TremStr
177	Tremolo Strings 2	TremStr2
178	Tremolo Strings 3	TremStr3
179	Pizzicato Strings	PizzStr
180	Pizzicato Strings 2	PizzStr2
181	Orchestral Harp	Harp
182	Orchestral Harp 2	Harp2
183	Yang Chin	YangChin
184	Timpani	Timpani
185	Timpani 2	Timpani2
186	String Ensembles	Strings
187	String Ensembles 2	Strings2
188	String Ensembles 3	Strings3
189	String Ensembles 4	Strings4
190	Strings & Brass	Str&Bras
191	60's Strings	60'sStr
192	Synth Strings	SynStrs
193	Synth Strings 2	SynStrs2
194	Synth Strings 3	SynStrs3
195	Synth Strings 4	SynStrs4
196	Synth Strings 5	SynStrs5
197	Choir Aahs	ChoirAah
198	Choir Aahs 2	ChoirAah2
199	Choir Aahs 3	ChorAah3
200	Voice Oohs	VoiceOoh
201	Voice Oohs 2	VoicOoh2
202	Humming	Humming
203	Anlong Voice	AnlVoice
204	Synth Voice	SynVoice
205	Synth Voice 2	SynVoic2
206	Orchestra hit	OrchHit
207	Orchestra Hit 2	OrchHit2
208	Bass Hit Plus	BassHit
209	6th Hit	6thHit
210	Euro Hit	EuroHit

Brass		
211	Trumpet	Trumpet
212	Trumpet 2	Trumpet2
213	Dark Trumpet	DarkTrp
214	Trombone	Trombone
215	Trombone 2	Trmbone2
216	Trombone 3	Trmbone3
217	Bright Trombone	BritBone
218	Tuba	Tuba
219	Tuba 2	Tuba2
220	Muted Trumpet	MuteTrp
221	Muted Trumpet 2	MuteTrp2
222	Muted Trumpet 3	MuteTrp3
223	French horn	FrHorn
224	French horn 2	FrHorn2
225	French horn 3	FrHorn3
226	Brass Section	Brass
227	Brass Section 2	Brass2
228	Brass Section 3	Brass3
229	Synth Brass	SynBrass
230	Synth Brass 2	SynBras2
231	Synth Brass 3	SynBras3
232	Synth Brass 4	SynBras4
233	Synth Brass 5	SynBras5
234	Synth Brass 6	SynBras6
235	Synth Brass 7	SynBras7
236	Synth Brass 8	SynBras8
237	Analog Synth Brass	AnaBrass
238	Analog Synth Brass 2	AnaBras2
239	Analog Synth Brass 3	AnaBras3
240	Jump Brass	JumpBras
241	Jump Brass 2	JumpBrs2
242	Funny	Funny
243	Funny 2	Funny2
Reed		
244	Soprano Sax	SprmoSax
245	Soprano Sax 2	SprnSax2
246	Soprano Sax 3	SprnSax3
247	Alto Sax	AltoSax
248	Alto Sax 2	AltoSax2
249	Alto Sax 3	AltoSax3
250	Tenor Sax	TenorSax
251	Tenor Sax 2	TenoSax2
252	Tenor Sax 3	TenoSax3
253	Baritone Sax	BariSax
254	Baritone Sax 2	BariSax2
255	Baritone Sax 3	BariSax3
256	Oboe	Oboe
257	Oboe 2	Oboe2
258	Oboe 3	Oboe3
259	2 oboes	2Oboes
260	English horn	EngHorn
261	English Horn 2	EngHorn2
262	English Horn 3	EngHorn3

263	2 English Horns	2EngHons
264	Bassoon	Bassoon
265	Bassoon 2	Bassoon2
266	Bassoon 3	Bassoon3
267	2 Bassoons	2Bassoons
268	Clarinet	Clarinet
269	Clarinet 2	Clarinet2
270	Clarinet 3	Clarinet3
271	2 Clarinets	2Clarins
Pipe		
272	Piccolo	Piccolo
273	Piccolo 2	Piccolo2
274	Piccolo 3	Piccolo3
275	2 piccolos	2Piccolos
276	Sweet Flute	SweeFlood
277	Flute	Flute
278	Flute 2	Flute2
279	Flute 3	Flute3
280	2 Flutes	2Flutes
281	Recorder	Recorder
282	Recorder 2	Recorde2
283	2 Recorders	2Records
284	Pan Flute	PanFlute
285	Pan Flute 2	PanFlood2
286	Sweet Pan Flute	SwPanFlu
287	Blown bottle	Bottle
288	Blown bottle 2	Bottle2
289	Shakuhachi	Shakhchi
290	Shakuhachi 2	Shakhch2
291	Whistle	Whistle
292	Whistle 2	Whistle2
293	Ocarina	Ocarina
294	Ocarina 2	Ocarina2
Synth Lead		
295	Lead 1 (square)	SquareLd
296	Lead 1a (square) 2	SquarLd2
297	Lead 1 (square) 3	SquarLd3
298	Lead 1b (sine)	SineLead
299	Lead 2 (sawtooth)	SawLead
300	Lead 2a (sawtooth) 2	SawLead2
301	Lead 2 (sawtooth) 3	SawLead3
302	Lead 2b (saw + pulse)	SawPlsLd
303	Lead 2c (double sawtooth)	DubSawLd
304	Lead 2d (sequenced analog)	SquAnaLd
305	Lead 2d (sequenced analog) 2	SqAnaLd2
306	Wavy Sawtooth	WavySaw
307	Bauble Lead	BaubleLd
308	Super Analog	SuperAna
309	Lead 3 (calliope)	CaliopLd
310	Lead 3 (calliope) 2	CalipLd2
311	Lead 4 (chiff)	ChiffLd
312	Lead 4 (chiff) 2	ChiffLd2
313	Lead 4 (chiff) 3	ChiffLd3
314	Lead 5 (charang)	CharanLd

315	Lead 5 (charang) 2	CharaLd2
316	Lead 5 (charang) 3	CharaLd3
317	Lead 5 (charang) 4	CharaLd4
318	Lead 5a (wire lead)	WireLead
319	Lead 5a (wire lead) 2	WireLd2
320	Lead 6 (voice)	VoiceLd
321	Lead 6 (voice) 2	VoiceLd2
322	Lead 7 (fifths)	FifthsLd
323	Lead 7 (fifths) 2	FifthsLd2
324	Lead 8 (bass + lead)	BassLead
325	Lead 8 (bass + lead) 2	BasLead2
326	Lead 8 (bass + lead) 3	BasLead3
327	Lead 8a (soft wrl)	SftWrlLd
328	Massiness	Massin
329	Square	Square
330	Slow Square Lead	SlwSquLd
331	Sine solo	SineSolo
332	Square Lead 4	SquarLd4
333	Thick Square	ThickSqu
334	2Oscillators Lead	2OscLd
335	Wavy Sawtooth 2	WavySaw2
336	Analog Lead	AnaLead
337	Big Lead	BigLead
338	Fat Lead	FatLead
339	PWM 4th	Rezz4th
340	Delayed Lead	DelyLead
341	Delayed Lead 2	DlyLead2
342	Fifth Lead	FifLead
343	Corrie	Corrie
344	Quint	Quint
Synth Pad		
345	Pad 1 (new age)	NewAge
346	Pad 1 (new age) 2	NewAge2
347	Pad 2 (warm)	WarmPad
348	Pad 2 (warm) 2	WarmPad2
349	Pad 2a (sine pad)	SinePad
350	Pad 3 (polysynth)	PolySyn
351	Pad 3 (polysynth) 2	PolySyn2
352	Pad 3 (polysynth) 3	PolySyn3
353	Pad 3 (polysynth) 4	PolySyn4
354	Pad 4 (choir)	ChoirPad
355	Pad 4 (choir) 2	ChoirPd2
356	Pad 4a (itopia)	ItopiaPd
357	Pad 5 (bowed)	BowedPad
358	Pad 5 (bowed) 2	BowedPd2
359	Pad 6 (metallic)	MetalPad
360	Pad 6 (metallic) 2	MetalPd2
361	Pad 7 (halo)	HaloPad
362	Pad 7 (halo) 2	HaloPad2
363	Pad 8 (sweep)	SweepPad
364	Pad 8 (sweep) 2	SweepPd2
365	Pad 8 (sweep) 3	SweepPd3
366	Pan Pad	PanPad
367	Pan Pad 2	PanPad2

368	Dipolar Pad	DipolPad
369	PWM Pad	PWMPad
370	Warmly Pad	WarmlyPd
371	Horn Pad	HornPad
372	Click Pad	ClickPad
373	Analog pad	AnalogPd
374	80's Poly Pad	80'sPoly
375	PWM 4th Soft	Rezz4thS
376	Synth Calliope Soft	CalioLdS
377	Soft vox	SoftVox
378	5th SawWave	5thSaw
379	5th Lead Soft	FiftLdSf
380	Slow Square	SISquare
381	New Year Pad	NewYear
382	Space Voice	SpcVoice
383	Rising	Rising
384	Congregate	Congrega
Synth SFX		
385	FX 1 (rain)	FXRain
386	FX 1 (rain) 2	FXRain2
387	FX 2 (soundtrack)	Soundtrk
388	FX 2 (soundtrack) 2	Sondtrk2
389	Prelude	Prelude
390	FX 3 (crystal)	Crystal
391	FX 3 (crystal) 2	Crystal2
392	FX 3a (synth mallet)	SynMalet
393	FX 4 (atmosphere)	Atmosphr
394	FX 4 (atmosphere) 2	Atmosph2
395	Warm Air	WarmAir
396	FX 5 (brightness)	Bright
397	Smog	Smog
398	FX 6 (goblins)	Goblins
399	FX 6 (goblins) 2	Goblins2
400	Choir Bell	ChorBell
401	Choir Bell 2	ChorBel2
402	FX 7 (echoes)	Echoes
403	FX 7 (echoes) 2	Echoes2
404	FX 7b (echo pan)	EchoPan
405	FX 7a (echo bell)	EchoBell
406	FX 7a (echo bell) 2	EchoBel2
407	FX 7a (echo bell) 3	EchoBel3
408	FX 8 (sci-fi)	Sci-Fi
409	FX 8 (sci-fi) 2	Sci-Fi2
Ethnic Misc.		
410	Sitar	Sitar
411	Sitar 2	Sitar2
412	Banjo	Banjo
413	Banjo 2	Banjo2
414	Shamisen	Shamisen
415	Shamisen 2	Shamise2
416	Koto	Koto
417	Koto 2	Koto2
418	Taisho Koto	TaishoKt
419	Kalimba	Kalimba

420	Kalimba 2	Kalimba2
421	Bag Pipe	BagPipe
422	Bag Pipe 2	BagPipe2
423	Fiddle	Fiddle
424	Fiddle 2	Fiddle2
425	Fiddle 3	Fiddle3
426	Shanai	Shanai
427	Shanai 2	Shanai2
Percussive		
428	Tinkle Bell	TnklBell
429	Agogo	Agogo
430	Steel drums	SteelDrm
431	Woodblock	WoodBlok
432	Castanets	Castanet
433	Taiko drum	TaikoDrm
434	Concert Bass Drum	ConBasDm
435	Acoustic Bass Drum	BassDrum
436	Jazz Kick	JazzKick
437	Side Stick	SidStick
438	Analog Rim Shot	AnRiShot
439	Acoustic snare	A.Snare
440	Jazz snare	JazSnare
441	Brush Tap	SrushTap
442	Concert SD	ConcetSD
443	Hand Clap	HandClap
444	Tom	Tom
445	Brush Tom	BrushTom
446	Closed hi-hat	ClosedHH
447	Analog Closed Hi-hat	AnCloHH
448	Pedal hi-hat	PedalHH
449	Open Hi-hat	OpenHH
450	Crash Cymbal	CrashCym
451	Analog Cymbal	AnaCym
452	Ride cymbal	RideCym
453	China Cymbal	ChinaCym
454	Ride Bell	RideBell
455	Tambourine	Tambouri
456	Splash Cymbal	SplashCy
457	Cowbell	Cowbell
458	Analog cowbell	AnaCowbl
459	High Bongo	HiBongo
460	Low bongo	LoBongo
461	Mute Hi Conga	MuHiCnga
462	Open Hi Conga	OpHiCnga
463	Low conga	LowConga
464	Analog Hi Conga	AnHiCnga
465	Analog Mid Conga	AnMiCnga
466	Analog Low Conga	AnLoCnga
467	High Timbale	HiTimbal
468	Low Timbale	LoTimbal
469	Cabasa	Cabasa
470	Maracas	Maracas
471	Analog maracas	AnMaracas
472	Short guiro	ShGuiro

473	Long guiro	LoGuiro
474	Claves	Claves
475	Mute Cuica	MuCuica
476	Open Cuica	OpCuica
477	Mute Triangle	MuTrgle
478	Open Triangle	OpTrgle
479	Shaker	Shaker
480	Mute Surdo	MuSurdo
481	Open Surdo	OpSurdo
482	Melodic Tom	MeloTom
483	Melodic Tom 2	MeloTom2
484	Synth drum	SynDrum
485	Rhythm Box Tom	RhythBox
486	Electric Drum	ElecDrum
487	Reverse Cymbal	RevCymbI
SFX		
488	Guitar Fret Noise	FretNoiz
489	Guitar Cutting Noise	GtCtNoiz
490	Acoustic Bass String Slap	BsStSlap
491	Breath Noise	BrthNoiz
492	Flute Key Click	FlKeyClk
493	Seashore	Seashore
494	Rain	Rain
495	Thunder	Thunder
496	Wind	Wind
497	Stream	Stream
498	Bubble	Bubble
499	Bird Tweet	Tweet
500	Bird Tweet 2	Tweet2
501	Dog	Dog
502	Horse Gallop	HouseGlp
503	Telephone Ring	Telephone
504	Telephone Ring 2	Telephone2
505	Door Creaking	DoorCrek
506	Door	Door
507	Scratch	Scratch
508	Wind Chime	WindChim
509	Helicopter	Helicptr
510	Car Engine	CarEngin
511	Car Stop	CarStop
512	Car Pass	CarPass
513	Car Crash	CarCrash
514	Siren	Siren
515	Train	Train
516	Jetplane	Jetplane
517	Starship	Starship
518	Burst Noise	BurtNois
519	Applause	Applause
520	Laughing	Laughing
521	Screaming	Scream
522	Punch	Punch
523	Heart Beat	HeartBet
524	Footsteps	Footstep
525	Gunshot	Gunshot

526	Machine Gun	MachnGun
527	Laser Gun	Laser Gun
528	Explosion	Explosio
Combined Voice		
529	Stereo Piano & Strings Pad	Pn&StrPd
530	Stereo Piano & Choir	Pn&Choir
531	Stereo Piano & Synth Strings	Pn&SyStr
532	Stereo Piano & Warm Pad	Pn&WrmPd
533	Stereo Piano & Soft EP	Pn&SfEP
534	FM Electric Piano	FMEP
535	Digital piano	DigitlPn
536	E.Piano & Strings	EP&Str
537	E.Piano & Acoustic Guitar	EP&Gtr
538	E.Piano & Vibraphone	EP&Vibra
539	E.Piano 2 & Pad	EP2&Pad
540	E.Piano 2 & Strings	EP2&Str
541	Harpichord & Stereo Strings	Hrps&Str
542	Music Box & Stereo Strings	MBox&Str
543	Vibraphone & Stereo Strings	Vib&Str
544	Vibraphone Octave	VibraOct
545	Vibraphone & Marimba & Kalimba	Vib&M&K
546	Marimba & Kalimba	Mar&Cal
547	Marimba delay	MarDelay
548	Xylophone Octave	XylopOct
549	Organ & Stereo Strings	Orgn&Str
550	Stereo Organ & Piano	Orgn&Pno
551	Rock Organ & Strings	RkOr&Str
552	Church Organ & Choir	ChOr&Cho
553	Church Organ & Strings	ChOr&Str
554	Acoustic Guitar & Flute	Gtr&Flood
555	Acoustic Guitar & Clavi	Gtr&Clav
556	24 String Guitar	24StrGtr
557	Steel Guitar & Warm Pad	StGt&Pad
558	Stereo Strings & Horn	Str&Horn
559	Orchestra	Orchestr
560	Full Strings	FullStr
561	Full Strings 2	FullStr2
562	Symphonic	Symphon
563	Stereo Choir & Strings	Cho&Str
564	Stereo Choir & Steel Guitar	Cho&Gtr
565	3 Trumpet Loose	3Trumpet
566	Trombone & Stereo Strings	Tomb&Str
567	3 Trombones Loose	3Trmbone
568	3 Muted Trumpets Loose	3MuTrump
569	Club Brass	ClubBras
570	Brass & Woodwinds	Brs&Wood
571	Woodwinds & Strings	Wood&Str
572	Section Woods Small	WoodSmal
573	Pan Flute & Strings Pad	PnFl&Str
574	Koto & Shamisen	Kto&Sham
575	Flute & Clarinet	Flu&Clar
576	Flute & Oboe	Flu&Oboe
577	Flute & Bassoon	Flu&Bn
578	Flute & Oboe & Clarinet	Fl&Ob&Cl

579	Flute & Clarinet & Bassoon	Fl&Cl&Bn
580	Flute & Oboe & Bassoon	Fl&Ob&Bn
581	Flute Octave	FluteOct
582	Flute & Oboe Octave	Fl&ObOct
583	Flute & Clarinet Octave	Fl&ClOct
584	Oboe & Bassoon	Oboe&Bn
585	Oboe & Clarinet	Ob&Cl
586	Oboe & Clarinet & Bassoon	Whether&Cl&Bn
587	Oboe Octave	OboeOct
588	Oboe & Clarinet Octave	Ob&ClOct
589	Oboe & Bassoon Octave	Ob&BnOct
590	Clarinet & Bassoon	Cl&Bn
591	Clarinet & Oboe Octave	Cl&ObOct
Chinese Instruments		
592	Standard set	StandSet
593	Room Set	RoomSet
594	Power Set	PowerSet
595	Electronic set	ElectSet
596	Analog set	AnalgSet
597	Jazz set	JazzSet
598	Brush Set	BrushSet
599	Orchestra Set	OrcheSet
600	SFX Set	SFXSet

Styles overview

NO.	English name	LCD Name
8BEAT		
1	8Beat Ballad	8BtBld
2	8Beat Piano	8BtPiano
3	8Beat 1	8Beat1
4	Guitar Pop 1	GtPop1
5	8Beat Hip Hop	8BtHiHop
6	8Beat Blues Rock	8BtBluRk
7	8Beat 2	8Beat2
8	Sweet beat	SweetBt
9	8Beat 3	8Beat3
10	Rhythm&Beat 2	Rhy&Bt2
16BEAT		
11	16Beat 1	16Beat1
12	16Beat Radio 1	16BtFuk1
13	16Beat Ballad 1	16BtBld1
14	16Beat R&B	16BtR&B
15	Pop 16Beat 1	Pop16Bt1
16	16Beat Funk 2	16BtFuk2
17	16Beat Dance	16BtDanc
18	Pop 16Beat 2	Pop16Bt2
19	16Beat 2	16Beat2
20	Pop 16Beat 3	Pop16Bt3
21	Pop 16Beat 4	Pop16Bt4
22	Modern 16Beat	Modr16Bt
23	16Beat Hot	16BtHot
24	16Beat Modern	16BtModr
25	16Beat Funk 3	16BtFuk3
26	16Beat 3	16Beat3
27	Cool beat	CoolBeat
28	16Beat Ballad 2	16BtBld2
29	16Beat 4	16Beat4
30	Pop shuffle	PopShfl
POP&BALLAD		
31	Pop Rock 1	PopRock1
32	Pop Dance 1	PopDanc1
33	Pop Fusion	PopFusn
34	Analog Night 1	AnalgNt1
35	6/8 pop	6/8Pop
36	Brit. Pop 1	BritPop1
37	Brit. Pop 2	BritPop2
38	Pop hit	PopHit
39	Fusion Shuffle	FusShufl
40	Analog Night 2	AnalgNt2
41	Guitar Pop 3	GtPop3
42	Pop beat	PopBeat
43	Soft beat	SoftBeat
44	60's Pop	60'sPop
45	Sting Latin	StigLatn
46	R&B Ballad 1	R&BBld1
47	Guitar Ballad	GtBallad
48	Ballad Rock	BaldRock
49	Piano Pop	PianoPop
50	Soft ballad	SoftBald
51	Natural Ballad	NatulBld
52	Love Ballad	LoveBald

53	Easy Ballad	EasyBald
54	Miami Folk	MiamiBld
55	Slow Ballad	SlowBald
56	Folk Ballad	FolkBald
57	Pop Ballad 1	PopBald1
58	Pop Ballad 2	PopBald2
59	EP Ballad	EPBallad
60	New R&B Ballad	NewRBBld
ROCK		
61	Skirt	Skirt
62	New Wave	NewWave
63	Ska	Ska
64	Pop Rock 2	PopRock2
65	Slow Rock	SlowRock
66	70's Rock&Roll	70'sRock
67	Folk Rock	FolkRock
68	Soft Rock	SoftRock
69	Old Rock	OldRock
70	Easy Rock	EasyRock
71	New Shuffle	NewShufl
72	Rock Hip Hop	RkHipHop
73	Rock&Roll 1	R'N'R1
74	Rock Shuffle	RockShfl
75	Rock&Roll 2	R'N'R2
BALLROOM		
76	Tango 1	Tango1
77	Spain Matador	Matador
78	Twist 1	Twist1
79	Twist 2	Twist2
80	Big Band Fox	BandFox
81	Tango 2	Tango2
82	Slow Fox	SlowFox
83	Slow Waltz 1	SlowWlz1
84	Swing Fox	SwingFox
85	Salsa 1	Salsa1
86	Cha Cha 1	ChaCha1
87	Cha Cha 2	ChaCha2
88	Beguine 1	Beguine1
89	Beguine 2	Beguine2
90	Rumba 1	Rumba1
91	Samba 1	Samba1
92	Samba 2	Samba2
93	Jive	Jive
94	Fox Trot	FoxTrot
DANCE		
95	Techno 1	Techno1
96	Hip Hop 1	HipHop1
97	House 1	House1
98	Down beat	DownBeat
99	Progressive	Progress
100	Rap 1	Rap1
101	Disco	Disco
102	70's disco	70'sDisc
103	Club Dance	ClubDanc
104	Euro Dance	EuroDanc
105	Garage	Garage

SOUL & FUNK		
106	Radio 1	Radio1
107	Classic radio	ClasFunk
108	Jay R&B	JayR&B
109	Gospel Swing	GopSwing
110	Gospel	Gospel
111	Radio 2	Radio2
112	Electric Funk	ElecFunk
113	Groove funk	GrooveFk
114	Rubber Funk	RubberFk
115	Cool Funky	ColFunky
116	Jazz Funk	JazzFunk
117	Groove	Groove
118	Soul	Soul
119	Hip Hop Soul	HipHopSl
120	Hip hop beat	HipHopBt
121	R&B	R&B
122	British Soul Pop	BritSoul
123	Latin Jazz 1	LatinJz1
124	Big Band 1	BigBand1
125	Dixieland 1	Dixland1
126	Guitar Swing 1	GtSwing1
127	Broadway Big Band	BwayBand
128	Swing	Swing
129	Latin Jazz 2	LatinJz2
130	Fusion	Fusion
131	Acid Jazz	AcidJazz
132	Cool Jazz Ballad	CoolJzBd
133	Swing Shuffle	SwingSfl
134	Big Band Medium	BandMid
135	Ragtime	Ragtime
COUNTRY		
136	Country Pop 1	CntyPop1
137	Bluegrass 1	Bluegrass1
138	8Beat Country	8BtCnty
139	Modern Country	ModrCnty
140	Country Pop 2	CntyPop2
141	Bluegrass 2	Blugrass2
142	2/4 Country	2/4Cntry
143	Country Quick Steps	QuickStp
144	Country Folk	CntyFolk
145	Country Shuffle	CnyShufl
LATIN&LATIN DANCE		
146	Samba 3	Samba3
147	Bossa Nova	BosaNova
148	Latin	Latin
149	New Reggae	NewRegga
150	Reggae Dance	DanRegga
151	Paso Doble	Pasodobl
152	Lite Bossa	LteBossa
153	Latin Rock	LatinRck
154	Beguine 3	Beguine3
155	Slow Bolero	SlBolero
156	Disco Samba	DscSamba
157	Mambo	Mambo
158	Meneito	Meneito

159	Rumba 2	Rumba2
160	Rumba 3	Rumba3
161	Lambada	Lambada
162	Pop Cha Cha 1	PChaCha1
WALTZ&TRADITIONAL		
163	Waltz	Waltz
164	Old Waltz	OldWaltz
165	English Waltz	EngWaltz
166	German Waltz	GemWaltz
167	Italian mazurka	ItaMazuk
168	Mexico Waltz	MexWaltz
169	Vienna Waltz	VinaWltz
170	Slow Waltz 2	SlwWltz2
171	Jazz Waltz	JazzWltz
172	Polka	Polka
173	6/8 March	6/8March
174	German polka	GemPolka
175	Party polka	PtyPolka
176	Army March	ArmMarch
177	March	March
178	US March	USMarch
179	French Musette	FMusette
180	Mazurka	Mazurka
WORLD		
181	Enka Ballad	EnkaBald
182	Laendler	Laendler
183	Hawaiian	Hawaiian
184	Sirtake	Sirtake
185	Dangdut	Dangdut
186	6/8 Flipper	6/8Flip
187	New Age	NewAge
188	Tarantella	Tarantula
189	Scottish	Scottish
190	Norteno	Norteno
PIANIST		
191	Pianist 1	Pianist1
192	Pianist 2	Pianist2
193	Pianist 3	Pianist3
194	March 1	March1
195	Italian polka	ItaPolka
196	Slow Waltz	SlwWltz
197	Waltz 1	Waltz1
198	Waltz 2	Waltz2
199	Waltz 3	Waltz3
200	Vienna Waltz	VinaWtz
201	Latin	Latin
202	Tango	Tango
203	Lambada	Lambada
204	Samba	Samba
205	ChaCha	ChaCha
206	Beguine	Beguine
207	Salas	Salas
208	Pop Bossa	PopBossa
209	Jazz 1	Jazz1
210	Jazz 2	Jazz2
211	Jazz 3	Jazz3

212	Jazz 4	Jazz4
213	Jazz 5	Jazz5
214	Jazz 6	Jazz6
215	Jazz 7	Jazz7
216	Boogie	Boogie
217	Jive	Jive
218	Dixland	Dixland
219	Blues 1	Blues1
220	Blues 2	Blues2
221	Jazz blouse	JazBlouse
222	Pop 1	Pop1
223	Pop 2	Pop2
224	Pop 3	Pop3
225	Pop 4	Pop4
226	Ballad 1	Ballad1
227	Ballad 2	Ballad2
228	Ballad 3	Ballad3
229	Ballad 4	Ballad4
230	6/8 Ballad 2	6/8Bld2

Song directory

NO.	English Name	LCD Name
1	Toccata	Toccata
2	Carry Me Back To Old Virginny	Virginny
3	El Condor Pasa	ElCondor
4	Five Hundred Miles	500Miles
5	Green Grass Of Home	GreenGrs
6	Greensleeves	Sleeves
7	Home Sweet Home	SwetHome
8	La Mer	LaMer
9	Long Long Ago	LongAgo
10	Massachusetts	Maschuse
11	Moon River	MoonRivr
12	My Darling Clementine	Clemtine
13	Never On Sunday	NeverSun
14	Oh! Carol	Oh!Carol
15	Susanna	Susanna
16	The Girl From Ipanema	Ipanema
17	Tombe La Neige	LaNeige
18	You Are My Sunshine	Sunshine
19	A Whiter Shade Of Pale	WhtShade
20	Again	Again
21	Mambo No. 5	MamboNo5
22	Are You Lonesome Tonight?	Lonesome
23	Around The World	AroWorld
24	Auld Lang Syne	LangSyne
25	Hail Mary	AveMaria
26	Beyond The Reef	BeyndRef
27	Blue Tango	BluTango
28	Brazil	Brazil
29	Bridal March	Bridal
30	Can't Help Fallin' In Love	InLove
31	Chanson Du Toreador	Toreador
32	Danny Boy	DannyBoy
33	Do Re Wed	DoReMi
34	Ebb Tide	EbbTide
35	Fly Me To The Moon	FlyMoon
36	Happy Birthday To You	Birthday
37	Hey Jude	HeyJude
38	How Deep Is Your Love	DeepLove
39	If	If
40	In The Mood	InMood
41	Jingle Bells	JingBell
42	Joy To The World	JoyWorld
43	La Paloma	LaPaloma
44	La Playa	LaPlaya
45	La Reine De Saba	Saba
46	Lara'S Theme From "Doctor Zhivago"	Zhivago
47	Always In My Heart	MyHeart
48	Mambo No. 8	MamboNo8
49	Misty	Misty
50	My Way	MyWay
51	Annie Laurie	AnnieLa
52	One Way Ticket To The Blues	OWTickets
53	Only You	OnlyYou
54	Petite Fleur	Fleur

55	Red River Valley	RedRiver
56	Rhythm Of The Rain	RhymRain
57	Rock Around The Clock	Skirt
58	Sail Along Silv'ry Moon	SilyMoon
59	Sealed With A Kiss	Sealed
60	Siboney	Siboney
61	Silent Night	SlitNight
62	Speak Softly Love	SoftLove
63	Summertime	Summer
64	Superstar	Superstr
65	Sweet And Gentle	SwetGtle
66	Tennessee Waltz	Tennesse
67	The End Of The World	EndWorld
68	The Sound Of Silence	Silence
69	The Way We Were	TheWay
70	Top Of The World	TopWorld
71	Una Lacrima Sul Viso	Lacrima
72	Unchained Melody	Melody
73	Love Story	LoveStry
74	Words	Words
75	Yesterday	Yestday
76	Yesterday Once More	OnceMore
77	13 Jours En France	13France
78	A Lover'S Concerto	Concerto
79	Air For The G-String	G-String
80	On The Shonen Blue Danube	Danube
81	The Sleeping Beauty	SleepBty
82	La Traviata	LaTravia
83	Lullaby	Cradle
84	Mov. 2 Adagio Non Troppo Piano Sonata No. 9 In D	Sonata9
85	Piano Sonata No. 11 In A	Sonata11
86	Prelude In C	Prelude
87	Chinese Dance	ChDance
88	Emperor Waltz	Emperor
89	March Militaire	Militair
90	Symphony No. 40	Symphony
91	Hanon Piano Fingering 1	Hanon1
92	Hanon Piano Fingering 2	Hanon2
93	Hanon Piano Fingering 3	Hanon3
94	Hanon Piano Fingering 4	Hanon4
95	Hanon Piano Fingering 5	Hanon5
96	Basic Tutorial Beyer Piano 12	Beyer12
97	Basic Tutorial Beyer Piano 13	Beyer13
98	Basic Tutorial Beyer Piano 14	Beyer14
99	Basic Tutorial Beyer Piano 15	Beyer15
100	Basic Tutorial Beyer Piano 18	Beyer18
101	Cuckoo	Cuckoo
102	Basic Tutorial Beyer Piano 21	Beyer21
103	Basic Tutorial Beyer Piano 29	Beyer29
104	Butterfly	Buterfly
105	Basic Tutorial Beyer Piano 45	Beyer45
106	Christmas Eve	XmasEve
107	Basic Tutorial Beyer Piano 50	Beyer50
108	Basic Tutorial Beyer Piano 52	Beyer52
109	Basic Tutorial Beyer Piano 55	Beyer55

110	Basic Tutorial Beyer Piano 59	Beyer59
111	Beyer Eight Degrees Jump Etude	BeyrJump
112	Basic Tutorial Beyer Piano The Scale Of C Major	BeyerC
113	Basic Tutorial Beyer Piano 65	Beyer65
114	Basic Tutorial Beyer Piano 66	Beter66
115	Old Folks At Home (Piano)	OldFolk2
116	Basic Tutorial Beyer Piano The Scale Of G Major	BeyerG
117	Basic Tutorial Beyer Piano 70	Beyer70
118	Basic Tutorial Beyer Piano 72	Beyer72
119	Basic Tutorial Beyer Piano 73	Beyer73
120	Basic Tutorial Beyer Piano 74	Beyer74

Demo songs directory

NO.	English Name	LCD Name
1	Demo1	Demo1
2	Demo2	Demo2
3	Bossa Nova	BosaNova
4	Fusion	Fusion
5	Jazz	Jazz

MIDI implementation

Function		Transmitted	Recognized	Remarks
Basic Channel	Default Changed	1ch 1-16ch	ALL 1-16ch	
Mode	Default	x	3	
	Messages	x	3	
	Altered	*****	x	
Note Number	Note	0—127 *****	0—127 0—127	
	:True voice			
Velocity	Note on Note off	o 9nH,V=1-127 x (9nH,V=0)	o 9nH,V=1-127 o(9nH,V=0; 8nH,V=0-127)	
After Touch	key's Ch's	x x	x x	
Pitch Bend		o	o	
Control Change	0 1 5 6 7 10 11 64 65 66 67 80 81 91 93 120 121 123	o x x o o x x o x o o o x x x	o o o o o o o o o o o o o o o o	Bank Select Modulation Portamento Time Data Entry Volume Pan Expression Sustain Pedal Portamento ON/OFF Sostenuto Pedal Soft Pedal Reverb Program Chorus Program Reverb Level Chorus Level All Sound Off Reset All Controllers All Notes Off
Program Change	:true	o *****	o 0—127	
System Exclusive		x	o	
System Common	:SongPosition :Song Select :Tune	x x x	x x x	
System Real Time	:Clock :Commands	o x *1	x x *1	
Aux Messages	:LOCAL ON/OFF :Active sense :Reset	x x x	x o x	
Notes: *1 When the accompaniment is started, an FAH message is transmitted. When accompaniment is stopped, an FCH message is transmitted.				

- Mode 1: OMNI ON, POLY
- Mode 2: OMNI ON, MONO

- Mode 3: OMNI OFF, POLY
- Mode 4: OMNI OFF, MONO

- o: YES
- x: NO

WEEE Declaration (Waste of Electrical and Electronic Equipment)

Your product has been designed and manufactured using high quality materials and components that are recyclable and reusable. This symbol means that electrical and electronic equipment must be disposed of separately from household waste at the end of their service life.

Please dispose of this device at your local municipal collection point or at the recycling center.

Please help protect the environment in which we all live.

All specifications and appearance are subject to change without notice. All information was correct at the time of printing. Musikhaus Kirstein GmbH assumes no responsibility for the accuracy or completeness of the descriptions, photos or statements contained in this manual. Printed colors and specifications may vary slightly from the product. Products of Musikhaus Kirstein GmbH are distributed only through authorized dealers. Distributors and dealers are not representatives of Musikhaus Kirstein GmbH and are not authorized to legally bind Musikhaus Kirstein GmbH in any way, whether expressly or through conclusive action.

 **KIRSTEIN.de**

Musikhaus Kirstein GmbH

Bernbeurener Str. 11

86956 Schongau – Germany

Phone: 0049-8861-909494-0

Fax: 0049-8861-909494-19

