



 **KIRSTEIN.de**
We love music!



excellent sound

- Sauerstofffreies Kupfer
- Hochdichter Kupferschild
- Hochflexibler und robuster Außenmantel
- Handgelötet
- Säure- und ölfest
- Spannzangen und Zugentlastung
- Niedrige Leiterkapazität
- 3 Jahre Garantie
- Oxygen free copper
- High density copper shield
- Highly flexible and durable
- Soldered by hand
- Acid and oil proof
- Chuck type strain relief
- Low capacitance
- 3 years warranty



FR

Cet appareil
se recycle

À DÉPOSER
EN MAGASIN



À DÉPOSER
EN DÉCHÈTERIE



OU



FR



Points de collecte sur www.quefairedemesdechets.fr
Privilégiez la réparation ou le don de votre appareil !

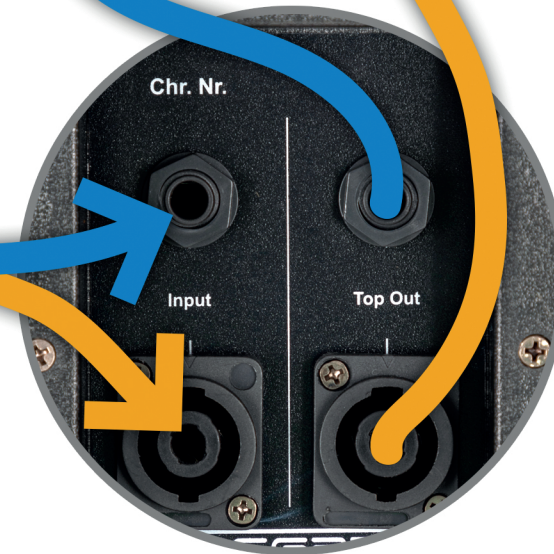
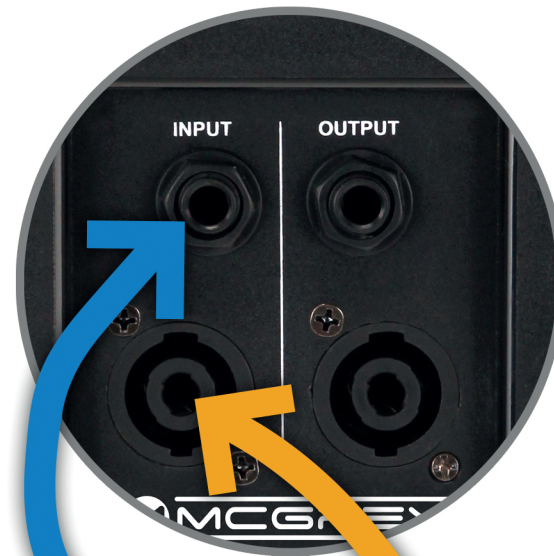

Datenblatt / Data sheet – McGrey Passive Speaker System PA / PAS

Typ / Type	McGrey PA-110 10"/2 Box	McGrey PA-120 12"/2 Box	McGrey PA-150 15"/2 Box	MCGrey PAS-115 15" SUB	MCGrey PAS-118 18" SUB
Artikelnummer / Article No.	00040480	00040481	00040482	00040483	00040484
Leistung / Power	50 Watt (RMS) 200Watt (Peak)	75 Watt (RMS) 300Watt (Peak)	100 Watt (RMS) 400Watt (Peak)	300 Watt (RMS) 1200Watt (Peak)	450 Watt (RMS) 1800Watt (Peak)
Übertragungsbereich / Frequency Range	70Hz – 18kHz	55Hz – 18kHz	40Hz – 18kHz	45Hz – 1.5kHz	38Hz – 1.5kHz
Lautsprecher / Woofer	1 x 10"	1 x 12"	1 x 15"	1 x 15"	1 x 18"
Anschlüsse / Connectors	SPK kompatibel (compatible) IN/OUT & Klinke (jack) 6.35mm In/Out			Speakon kompatibel / Speakon compatible Input = Fullrange / Top Out = Hihpass Filter 150Hz	
Impedanz / Impedance	8 Ohms	8 Ohms	8 Ohms	4 Ohms	4 Ohms
Abmessungen / Dimensions	B / W = 380(240) mm T / D = 290 mm H = 510 mm	B / W = 380(255) mm T / D = 310 mm H = 560 mm	B / W = 450(290) mm T / D = 345 mm H = 640 mm	B / W = 470 mm T / D = 480 mm H = 580 mm	B / W = 470 mm T / D = 480 mm H = 580 mm
Gewicht / Weight	10.2 kg	12.0 kg	16.2 kg	25.0 kg	33.1 kg

**Der Subwoofer enthält eine Frequenzweiche!
Bei Verwendung von Subwoofer mit Topteil:
Geben Sie das Signal erst in den Subwoofer.
Danach vom Subwoofer in das Topteil.**

**The subwoofer includes a crossover!
When using a subwoofer with top:
First, put the signal into the subwoofer.
Then from the subwoofer into the top.**



PA-110



PA-112



PA-115

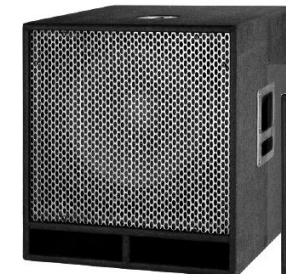

PAS-118



PAS-115

Installationsanleitung für McGrey PA/PAS Lautsprecher



Vor dem Anschließen der Lautsprecherleitungen stellen Sie sicher, dass der Verstärker abgeschaltet ist und kein Signal oder Spannung am Verstärkerausgang anliegt.

Sicherheitsbestimmungen:

Bitte packen Sie die Lautsprecher vorsichtig aus und prüfen Sie es auf eventuelle Transportschäden. Nehmen Sie die Lautsprecher erst in Betrieb, wenn Sie sich mit dieser Bedienungsanleitung vertraut gemacht haben. Es dürfen keine unbefugten Veränderungen an dem Gerät vorgenommen werden. Beim Hören von dauerhaft lauter Musik können Gehörschäden auftreten. Achten Sie auf einen angemessenen Lautstärkepegel.

Montage und Anschluss:

Stellen Sie die Lautsprecher auf einer ebenen, stabilen Fläche auf, für die Topteile benutzen Sie stabile Boxenständer oder Distanzstangen. **Die Subwoofer PAS-115 und PAS-118 beinhalten eine integrierte Frequenzweiche. Stecken Sie das Boxenkabel daher von der Endstufe zunächst in den Subwoofer, danach stecken Sie das zweite Boxenkabel vom Subwoofer in das Top-Teil. ACHTUNG: NIE ANDERSHERUM!** Beste Klangergebnisse erzielen Sie wenn Sie um die Lautsprecher und vor allen Dingen in Abstrahlrichtung entsprechende Abstände zu Möbeln und Gegenständen. einhalten. Benutzen Sie ausreichend dimensionierte (Durchmesser) und hochwertige Lautsprecherkabel. Achten Sie auf richtigen Anschluss aller Lautsprecher. Bei falschem Anschluss mehrerer Lautsprecher entstehen Phasenverschiebungen, Interferenzen und dadurch schlechte Soundqualität. Verwenden Sie nur Endstufen welche seitens Anschlussdaten die Lautsprecher nicht überlasten. Für Schäden aufgrund falschem oder mangelhaftem Anschluss oder Montage übernimmt der Hersteller keinerlei Garantie und kann nicht haftbar gemacht werden. Wenn sie die Lautsprecher angeschlossen haben drehen Sie den Lautstärkeregler am Verstärker auf „Null“ und schalten Sie den Verstärker ein. Erhöhen Sie dann langsam die Lautstärke auf den gewünschten Pegel.

WEEE-Erklärung



Ihr Produkt wurde mit hochwertigen Materialien und Komponenten entworfen und hergestellt, die recycelbar sind und wiederverwendet werden können. Dieses Symbol bedeutet, dass elektrische und elektronische Geräte am Ende ihrer Nutzungsdauer vom Hausmüll getrennt entsorgt werden müssen. Bitte entsorgen Sie dieses Gerät bei Ihrer örtlichen kommunalen Sammelstelle oder im Recycling Center. Bitte helfen Sie mit, die Umwelt, in der wir leben, zu erhalten.

Technische Änderungen und Änderungen im Erscheinungsbild vorbehalten. Alle Angaben entsprechen dem Stand bei Drucklegung. Für die Richtigkeit und Vollständigkeit der enthaltenen Beschreibungen, Abbildungen und Angaben übernimmt Musikhaus Kirstein GmbH keinerlei Gewähr. Abgebildete Farben und Spezifikationen können geringfügig vom Produkt abweichen. Musikhaus Kirstein GmbH - Produkte sind nur über autorisierte Händler erhältlich. Distributoren und Händler sind keine Handlungsbevollmächtigten von Musikhaus Kirstein GmbH und haben keinerlei Befugnis, die Musikhaus Kirstein GmbH in irgendeiner Weise, sei es ausdrücklich oder durch schlüssiges Handeln, rechtlich zu binden. Diese Bedienungsanleitung ist urheberrechtlich geschützt. Jede Vervielfältigung, bzw. jeder Nachdruck, auch auszugsweise, und jede Wiedergabe der Abbildungen, auch in verändertem Zustand, ist nur mit schriftlicher Zustimmung der Firma Musikhaus Kirstein GmbH gestattet.

Musikhaus Kirstein GmbH

Bernbeurener Str. 11 - 86956 Schongau – Germany

Installation guide for McGrey PA/PAS Speaker



Caution: Make sure that when you connect the speaker cables, the amplifier is turned OFF and no signal resp. output voltage is on output connectors of amplifier.

Safety Instructions:

Unpack the speakers carefully and check them for transport damages. Read the user manual before using the PA/PAS speakers. If the devices are damaged, don't use them. Do not open, inside the devices are no parts that unqualified people can service. Keep away from children. Please make sure that there is no obvious transport damage.

Installation:

Place speakers on flat solid ground, for the top speakers use solid speaker stands or distance poles. Adjust the speakers for the desired direction of emission. **The PAS-115 and PAS-118 subwoofers include an integrated crossover on the "Out" connectors (jack and SPK). Therefore, first plug the speaker cable from the power amplifier „Output“ into the subwoofer „Input“, then plug the second speaker cable from the subwoofer „Top out“ into the top speaker (e.g. McGrey PA-110 etc.). ATTENTION: NEVER THE OTHER WAY ROUND!** To get best sound quality make sure that no furniture or other objects are in direction of sound emission. Keep distance to objects and walls at left, right and rear sides. This will improve the sound quality. Use only speaker cables with sufficient diameter. Connect the speaker cable with amplifier terminal. If several speakers are used and connected wrong, there will be phase shifted sound emission and therefore interferences and bad sound quality. Use only amplifiers with output data according to speaker specification. Damages, which are caused by wrong wiring (connection) or wrong amplifier data, are not covered by supplier warranty. After you made all connections set volume level of your amplifier to "zero". Switch on your amplifier and increase volume to desired level.

WEEE-Declaration



Your product is designed and manufactured with materials and components of high quality, which can be recycled and reused. The symbol means that your product should be disposed of separately from household waste when it reaches its end of life. Please dispose of this equipment at your local collection point or recycling center. Please help to protect the environment in which we all live.

All specifications and appearances are subject to change without notice. All information was correct at time of printing. Musikhaus Kirstein GmbH does not guarantee for the accuracy or completeness of any description, photograph or statement contained in this manual. Printed colors and specifications may vary slightly from product.

Products from Musikhaus Kirstein GmbH are only sold through authorized dealer. Distributors and dealers are not agents of Musikhaus Kirstein GmbH and have no authority to bind Musikhaus Kirstein GmbH legally in any way. This manual is protected by copyright. Any copying or reprint, even in excerpts, is only allowed with written consent of Musikhaus Kirstein GmbH. The same applies to reproduction or copying of images, even in altered form.



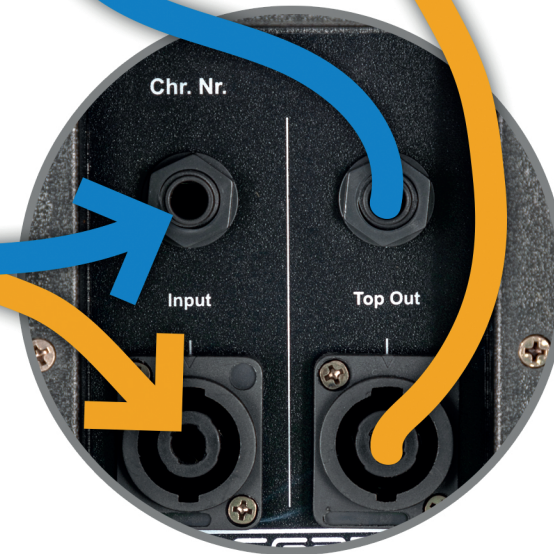
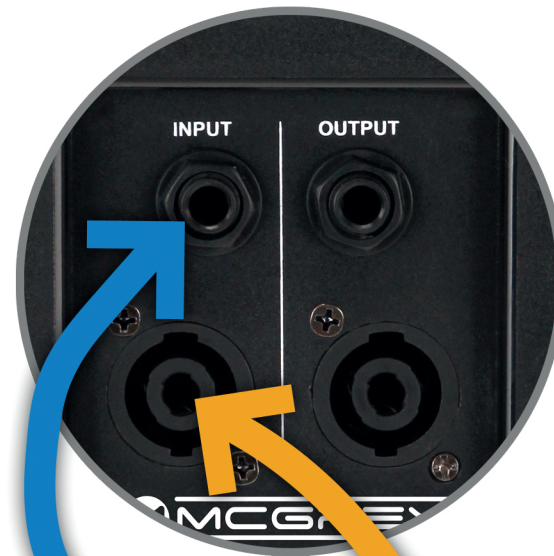

Datenblatt / Data sheet – McGrey Passive Speaker System PA / PAS

Typ / Type	McGrey PA-110 10"/2 Box	McGrey PA-120 12"/2 Box	McGrey PA-150 15"/2 Box	MCGrey PAS-115 15" SUB	MCGrey PAS-118 18" SUB
Artikelnummer / Article No.	00040480	00040481	00040482	00040483	00040484
Leistung / Power	50 Watt (RMS) 200Watt (Peak)	75 Watt (RMS) 300Watt (Peak)	100 Watt (RMS) 400Watt (Peak)	300 Watt (RMS) 1200Watt (Peak)	450 Watt (RMS) 1800Watt (Peak)
Übertragungsbereich / Frequency Range	70Hz – 18kHz	55Hz – 18kHz	40Hz – 18kHz	45Hz – 1.5kHz	38Hz – 1.5kHz
Lautsprecher / Woofer	1 x 10"	1 x 12"	1 x 15"	1 x 15"	1 x 18"
Anschlüsse / Connectors	SPK kompatibel (compatible) IN/OUT & Klinke (jack) 6.35mm In/Out			Speakon kompatibel / Speakon compatible Input = Fullrange / Top Out = Hihpass Filter 150Hz	
Impedanz / Impedance	8 Ohms	8 Ohms	8 Ohms	4 Ohms	4 Ohms
Abmessungen / Dimensions	B / W = 380(240) mm T / D = 290 mm H = 510 mm	B / W = 380(255) mm T / D = 310 mm H = 560 mm	B / W = 450(290) mm T / D = 345 mm H = 640 mm	B / W = 470 mm T / D = 480 mm H = 580 mm	B / W = 470 mm T / D = 480 mm H = 580 mm
Gewicht / Weight	10.2 kg	12.0 kg	16.2 kg	25.0 kg	33.1 kg

**Der Subwoofer enthält eine Frequenzweiche!
Bei Verwendung von Subwoofer mit Topteil:
Geben Sie das Signal erst in den Subwoofer.
Danach vom Subwoofer in das Topteil.**

**The subwoofer includes a crossover!
When using a subwoofer with top:
First, put the signal into the subwoofer.
Then from the subwoofer into the top.**



PA-110



PA-112



PA-115



PAS-118



PAS-115

Installationsanleitung für McGrey PA/PAS Lautsprecher



Vor dem Anschließen der Lautsprecherleitungen stellen Sie sicher, dass der Verstärker abgeschaltet ist und kein Signal oder Spannung am Verstärkerausgang anliegt.

Sicherheitsbestimmungen:

Bitte packen Sie die Lautsprecher vorsichtig aus und prüfen Sie es auf eventuelle Transportschäden. Nehmen Sie die Lautsprecher erst in Betrieb, wenn Sie sich mit dieser Bedienungsanleitung vertraut gemacht haben. Es dürfen keine unbefugten Veränderungen an dem Gerät vorgenommen werden. Beim Hören von dauerhaft lauter Musik können Gehörschäden auftreten. Achten Sie auf einen angemessenen Lautstärkepegel.

Montage und Anschluss:

Stellen Sie die Lautsprecher auf einer ebenen, stabilen Fläche auf, für die Topteile benutzen Sie stabile Boxenständer oder Distanzstangen. **Die Subwoofer PAS-115 und PAS-118 beinhalten eine integrierte Frequenzweiche. Stecken Sie das Boxenkabel daher von der Endstufe zunächst in den Subwoofer, danach stecken Sie das zweite Boxenkabel vom Subwoofer in das Top-Teil. ACHTUNG: NIE ANDERSHERUM!** Beste Klangergebnisse erzielen Sie wenn Sie um die Lautsprecher und vor allen Dingen in Abstrahlrichtung entsprechende Abstände zu Möbeln und Gegenständen. einhalten. Benutzen Sie ausreichend dimensionierte (Durchmesser) und hochwertige Lautsprecherkabel. Achten Sie auf richtigen Anschluss aller Lautsprecher. Bei falschem Anschluss mehrerer Lautsprecher entstehen Phasenverschiebungen, Interferenzen und dadurch schlechte Soundqualität. Verwenden Sie nur Endstufen welche seitens Anschlussdaten die Lautsprecher nicht überlasten. Für Schäden aufgrund falschem oder mangelhaftem Anschluss oder Montage übernimmt der Hersteller keinerlei Garantie und kann nicht haftbar gemacht werden. Wenn sie die Lautsprecher angeschlossen haben drehen Sie den Lautstärkeregel am Verstärker auf „Null“ und schalten Sie den Verstärker ein. Erhöhen Sie dann langsam die Lautstärke auf den gewünschten Pegel.

WEEE-Erklärung



Ihr Produkt wurde mit hochwertigen Materialien und Komponenten entworfen und hergestellt, die recycelbar sind und wiederverwendet werden können. Dieses Symbol bedeutet, dass elektrische und elektronische Geräte am Ende ihrer Nutzungsdauer vom Hausmüll getrennt entsorgt werden müssen. Bitte entsorgen Sie dieses Gerät bei Ihrer örtlichen kommunalen Sammelstelle oder im Recycling Center. Bitte helfen Sie mit, die Umwelt, in der wir leben, zu erhalten.

Technische Änderungen und Änderungen im Erscheinungsbild vorbehalten. Alle Angaben entsprechen dem Stand bei Drucklegung. Für die Richtigkeit und Vollständigkeit der enthaltenen Beschreibungen, Abbildungen und Angaben übernimmt Musikhaus Kirstein GmbH keinerlei Gewähr. Abgebildete Farben und Spezifikationen können geringfügig vom Produkt abweichen. Musikhaus Kirstein GmbH - Produkte sind nur über autorisierte Händler erhältlich. Distributoren und Händler sind keine Handlungsbevollmächtigten von Musikhaus Kirstein GmbH und haben keinerlei Befugnis, die Musikhaus Kirstein GmbH in irgendeiner Weise, sei es ausdrücklich oder durch schlüssiges Handeln, rechtlich zu binden. Diese Bedienungsanleitung ist urheberrechtlich geschützt. Jede Vervielfältigung, bzw. jeder Nachdruck, auch auszugsweise, und jede Wiedergabe der Abbildungen, auch in verändertem Zustand, ist nur mit schriftlicher Zustimmung der Firma Musikhaus Kirstein GmbH gestattet.

Musikhaus Kirstein GmbH

Bernbeurener Str. 11 - 86956 Schongau – Germany

Installation guide for McGrey PA/PAS Speaker



Caution: Make sure that when you connect the speaker cables, the amplifier is turned OFF and no signal resp. output voltage is on output connectors of amplifier.

Safety Instructions:

Unpack the speakers carefully and check them for transport damages. Read the user manual before using the PA/PAS speakers. If the devices are damaged, don't use them. Do not open, inside the devices are no parts that unqualified people can service. Keep away from children. Please make sure that there is no obvious transport damage.

Installation:

Place speakers on flat solid ground, for the top speakers use solid speaker stands or distance poles. Adjust the speakers for the desired direction of emission. **The PAS-115 and PAS-118 subwoofers include an integrated crossover on the "Out" connectors (jack and SPK). Therefore, first plug the speaker cable from the power amplifier „Output“ into the subwoofer „Input“, then plug the second speaker cable from the subwoofer „Top out“ into the top speaker (e.g. McGrey PA-110 etc.). ATTENTION: NEVER THE OTHER WAY ROUND!** To get best sound quality make sure that no furniture or other objects are in direction of sound emission. Keep distance to objects and walls at left, right and rear sides. This will improve the sound quality. Use only speaker cables with sufficient diameter. Connect the speaker cable with amplifier terminal. If several speakers are used and connected wrong, there will be phase shifted sound emission and therefore interferences and bad sound quality. Use only amplifiers with output data according to speaker specification. Damages, which are caused by wrong wiring (connection) or wrong amplifier data, are not covered by supplier warranty. After you made all connections set volume level of your amplifier to "zero". Switch on your amplifier and increase volume to desired level.

WEEE-Declaration



Your product is designed and manufactured with materials and components of high quality, which can be recycled and reused. The symbol means that your product should be disposed of separately from household waste when it reaches its end of life. Please dispose of this equipment at your local collection point or recycling center. Please help to protect the environment in which we all live.

All specifications and appearances are subject to change without notice. All information was correct at time of printing. Musikhaus Kirstein GmbH does not guarantee for the accuracy or completeness of any description, photograph or statement contained in this manual. Printed colors and specifications may vary slightly from product.

Products from Musikhaus Kirstein GmbH are only sold through authorized dealer. Distributors and dealers are not agents of Musikhaus Kirstein GmbH and have no authority to bind Musikhaus Kirstein GmbH legally in any way. This manual is protected by copyright. Any copying or reprint, even in excerpts, is only allowed with written consent of Musikhaus Kirstein GmbH. The same applies to reproduction or copying of images, even in altered form.





Pronomic Amplifier TL 200, TL 400, TL 700, TL 1200

Art. Nr.: TL 200: 00063864
TL 400: 00021732
TL 700: 00021733
TL 1200: 00021734



Operating Manual

Revision: 06-2024

© 2020

This manual is protected by copyright. Any copying or reprint, even in excerpts, is only allowed with written consent of Musikhaus KIRSTEIN GmbH. The same applies to reproduction or copying of images, even in altered form.

Contents

Product Description	2
Power Supply	2
Scope of Delivery	2
SAFETY	3
Connections	3
Intended Purpose	3
Intended Use	4
Important Safety Instructions	4
Installation and Operation	4
Power Amplifier TL 200, TL 400; TL 700	5
Power Amplifier TL 1200	11
Block Diagram	18
Specifications	19
CLEANING & MAINTENANCE	19
SIMPLIFIED EU DECLARATION OF CONFORMITY	20
WEEE Declaration (Waste of Electrical and Electronic Equipment)	20

Thank you for purchasing this product. To ensure you will be completely satisfied with this product, read and understand this manual carefully before use. Keep the manual in a safe place. The Operating Manual must be passed on to all subsequent users.



Follow the Operating Manual!

⚠ WARNING

The signal word **WARNING** identifies hazards, which can result without precautions in serious injury.

⚠ NOTE

The signal word **NOTE** indicates general precautions, which should be observed in handling the product.

⚠ NOTE

Images used in this manual may differ slightly from the actual product, as long as it has no adverse effect on the properties and safety of the product.

⚠ NOTE

All personal formulations in these instructions are to be considered gender neutral.

These operating instructions apply to persons who have been supervised or instructed in the operation of the unit by a person responsible for their safety and who have proven to be able to handle the unit.

⚠ WARNING

Children should be supervised to ensure that they do not play with the unit. Do not leave the children unattended.

All information contained in this Operating Manual is accurate to the best of our knowledge and belief. Neither the author nor the publisher, however, can be held liable for damages or losses that arise in connection with the use of this Operating Manual.



Other product, brand or company designations specified in this document are possibly the trademarks of their respective owners. Compliance with all applicable copyright laws is the responsibility of the user of this document.

Product Description

The instructions in this manual apply to all TL Series power amplifiers. The operation and functions of these devices are identical unless stated otherwise.

All professional power amplifiers of the TL series have:

- volume control; Parallel balanced XLR and 1/4 "TRS inputs, stereo (dual channel), parallel input or bridged mono mode with selector switch.
- 3 selectable input sensitivities (sensitivity), clip limiter, ground lift switch, screw terminals (banana plug) and Speakon outputs.
- 2 fans with two speeds for cooling; Soft start function when switching on, silent switching on and off, independent DC and thermal overload protection on each channel, short circuit and loudspeaker protection, built-in current limiter.
- Front LED indicators: Power, Signal, Clip, Protect.
- Roadworthy, rugged 2U / 3U chassis.
- 230 V (50 Hz) AC and IEC power cord.

 <p>CAUTION RISK OF ELECTRIC SHOCK DO NOT OPEN</p> <p>ATTENTION; RISQUE DE CHOC ELECTRIQUE NE PAS OUVRI</p> <p>CAUTION: TO REDUCE THE RISK OF ELECTRIC SHOCK DO NOT REMOVE COVER (OR BACK) NO USER SERVICEABLE PARTS INSIDE REFER SERVICING TO QUALIFIED SERVICE PERSONNEL.</p>		Warning, electricity
		General warning sign

Power Supply

Check that the mains voltage corresponds to 230 V (50 Hz) AC selector switch. Using other voltages than specified can cause irreparable damage to the unit. The device must be connected directly to the mains. Do not use dimmer or controllable power supply.

Scope of Delivery

1. User manual
2. Power amplifier of the TL series
3. Power cable

SAFETY

**WARNING**

Before fitting or removing the unit, ensure that the power cord is disconnected from the mains.

**WARNING**

Make sure that the unit is positioned so that no one can trip over the power cord.

- 1.** Do not use this product near water (e.g. near a bathtub, sink, in a wet basement or near a swimming pool, etc.).
- 2.** Do not place this product near heat sources such as radiators, vents or other equipment (including amplifiers) that produce heat.
- 3.** Connected this product to a power supply that complies with the type described in the operating instructions or specified on the product only. Replace the fuse with one of the specified types, sizes and ratings only.
- 4.** The product should be serviced by qualified service personnel if:
 - A.** The power cord or plug has been damaged.
 - B.** Objects have fallen into the product or liquid has been spilled on the product.
 - C.** The product was exposed to rain.
 - D.** The product does not seem to function normally or it has a significant change in performance.
 - E.** The product has been dropped and / or the housing is damaged.
- 5.** Do not attempt to service the product beyond the points described in the user manual. All other service work should be assigned to qualified service personnel.

Connections

Before using the unit, ensure that your mains voltage corresponds to voltage indicated on the unit.

Intended Purpose

The power amplifiers of the TL series are designed for standard 19-inch rack-mounting.

Intended Use

Important Safety Instructions



This manual contains important information on the correct and safe operation of your Pronomic power amplifiers. If you have any questions, please contact your dealer.

- 1.** This product should only be used with a cart or stand that keeps it level and stable and prevents wobbling.
- 2.** The product should be positioned so that adequate ventilation is ensured.
- 3.** This product can be used in combination with speakers that can cause permanent hearing loss. Do not operate the device at high or uncomfortable volume for a long period of time. If you notice hearing loss or ringing in the ears, you should consult a doctor.
- 4.** Make sure that no objects fall into the housing openings and that no any liquids get through the housing openings.
- 5.** The product should never share an electrical outlet or extension cord with other devices as the power rating of the outlet or extension cord may be exceeded.
- 6.** The product should never be left plugged in when not in use for a long time.
- 7.** Make sure the power cord is undamaged.
- 8.** For mounting on the front rack rails, use screws with washers.
- 9.** When installing the power amplifier in the rack, attach the product to the front and rear rack rails. This prevents the device from being deformed.
- 10.** Never block the ventilation slots of the product.
- 11.** Do not place the product in a location with direct sunlight or heat from hot equipment or radiators. Excessive heat may adversely affect the housing and internal components.
- 12.** Installing the product in a damp or dusty environment may result in malfunction or accident.

Installation and Operation



Carefully open the shipping box and check the contents for any obvious damage. Each amplifier of the Pronomic TL series is fully tested before leaving the factory and should arrive in perfect condition. If you find any damage, immediately notify the shipping company. Keep the shipping box and all packing materials for inspection by the carrier.

Power Amplifier TL 200, TL 400; TL 700

WARNING Disconnect the unit from the power supply before installation.

1. ON / OFF SWITCH

to turn the device on or off.
Before turning the power amplifier on, check all connections and turn down the level controls. Temporary mute is normal when turning the power amplifier on or off.

Caution:

Always switch the power amplifier on last, after all other connected devices are switched on;

Always turn off the power amplifier before connecting any other equipment

2. POWER LED-INDICATORS

These LEDs are lit when the power is on.

3. CLIP-LED-INDICATORS

These LEDs light up when the input level of the output stage is exceeded by 3 dB (overload). When this occurs, you must either turn down the level controls on the power amp or lower the output level of the previous component so that the clip LED goes out. This avoids distortion in the sound image and prevents damage to the connected speakers.

4. SIGNAL-LED-INDICATORS

These LEDs are light up to confirm the presence of an input signal above 100 mV on this channel of the power amplifier.

5. PROTECT-LED-INDICATORS

These LEDs light up when the output connection of the output stage is short-circuited, the load impedance is too low or an internal malfunction occurs. If one of these LEDs lights up, switch off the power supply and check the connection of the output. Then turn on the power again.

6. LEVEL CONTROLS

to control the level of the signal that gets into each channel. The actual voltage attenuation of the power amplifier is displayed in dB.

Turn these controls counterclockwise when the SIGNAL LEDs are lit steadily (indicating an excessive input signal).

7. "BRIDGED"-LED-INDICATORS

These LEDs are lit when the "BRIDGE"-MODE is set.

8. "PARALLEL"-LED-INDICATORS

These LEDs are lit when the "PARALLEL"-MODE is set.

BACK

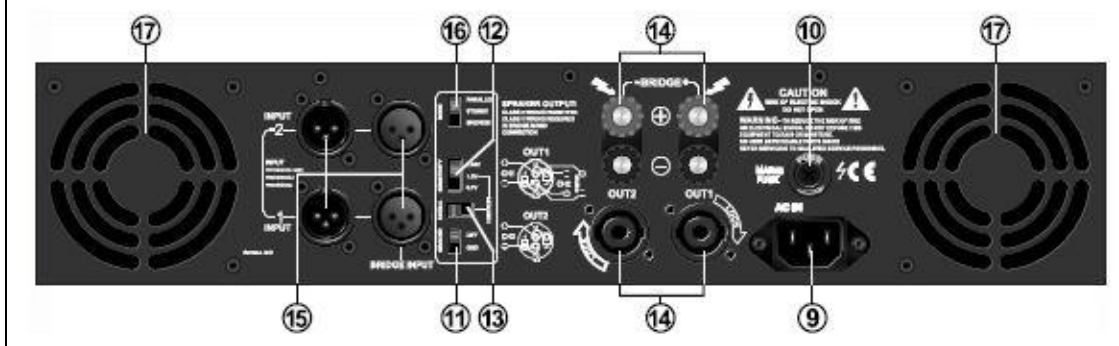

9. POWER-CONNECTOR

The connector is used to connect the amplifier to a power source.

(CAUTION: Only operate the device with the supplied cold device cable)

10. FUSE

Fuse holder for 5A-15A / 250V fuses. If these fuses blow repeatedly, switch off the device and have it serviced by qualified service personnel.

11. GROUND LIFT SWITCH

Turn on the switch to disconnect the device from the ground, if necessary, to eliminate "humming" by ground loops.

12. SENSITIVITY SELECTOR SWITCH

This switch is used to make the amplifier suitable for different input levels. 0,7V means that the amplifier reaches full output power when 0,7V is input. 1,0V means that the amplifier reaches full output power when 1,0V is input and so on. 1,0V can meet the requirements of most audio equipment. Only select 0,7V or 1,44 under special condition, such as when the signal is particularly weak or large.

13. COMPRESSOR SELECTOR

The TL series power amplifiers offer 2 settings: OFF or COMPRESSOR. This switch is the choice of compressor on and off. So whatever at any sensitivity, it is recommended to use compressor to avoid clipping.

14. OUTPUT CONNECTIONS FOR SPEAKERS

The connections are described under the model name.

15. INPUT CONNECTORS (XLR)

The XLR connector is equipped with balanced inputs. Symmetrical connections between the devices are recommended as they are less susceptible to AC hum. For long cable runs, an output impedance of the source of less than 600 ohms is required to avoid signal loss. Use the inputs for CH-1 and CH-2 for stereo operation (two-channel). Use only the CH-1 input for parallel or bridged mono operation. (See the user guide below for more information).

16. MODE SELECTION SWITCH

The TL series amplifiers offer three modes of operation: PARALLEL, STEREO and BRIDGED. Set the switch to one of the three positions as needed.

17. VENTILATION OPENINGS

The fan speed is automatically varied to maintain the correct internal operating temperature.

PARALL-MODE (MONO) - In this mode, both channels can be operated in parallel with the same signal without the need for a Y-cable. In this mode, the inputs for both channels are internally connected, so you only need to feed one signal into one of the channels. This further allows independent level control for each channel. It also allows for easy "Daisy-Chaining" with other power amplifiers by using the other channel of the input terminals.

⚠ NOTE

Do not select parallel mode if you supply the power amplifier with 2 separate signals.

⚠ NOTE

Do not use unbalanced and balanced cables at the same time, otherwise hum may occur.

STEREO-MODE - This is the most commonly used mode and allows independent control of two separate signals, such as stereo playback, main and monitor live mix, and bi-amp operation (highs in one channel and lows in the other).

BRIDGED-MODE (MONO) - This mode combines the power of both channels to drive a single speaker. In this mode, the power amplifier generates 4 times peak power and 3 times continuous power in a 4 or 8 ohm speaker, as each channel can deliver separately in stereo or parallel mode.

⚠ WARNING

In this mode, the power amplifier can power a loudspeaker with high power. Make sure the speaker, connectors, and cabling is adequate for performance. Please note that with a 4-ohm loudspeaker, the mains fuse can blow during prolonged overload. Check that the power amplifier is not overloaded when setting this mode.
Connect the input signal to the CH-1 input to bypass the mono operation.

The following instructions describe the most common ways to build the power amp into a sound system.

⚠ WARNING Turn off the power amplifier before making the connections.

The TL series power amplifiers can be operated in one of three modes (stereo, bridged mono, end-parallel mono).

⚠ WARNING Observe the following wiring diagrams for connecting the loudspeakers.

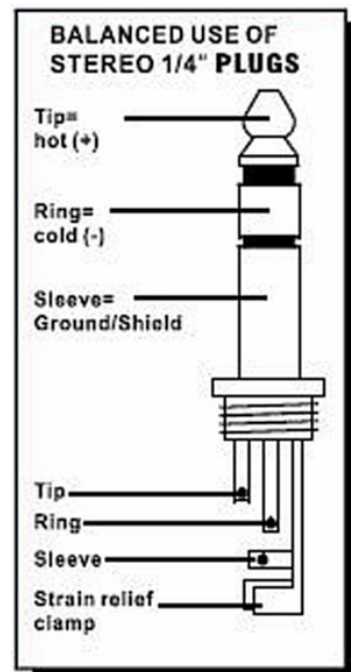
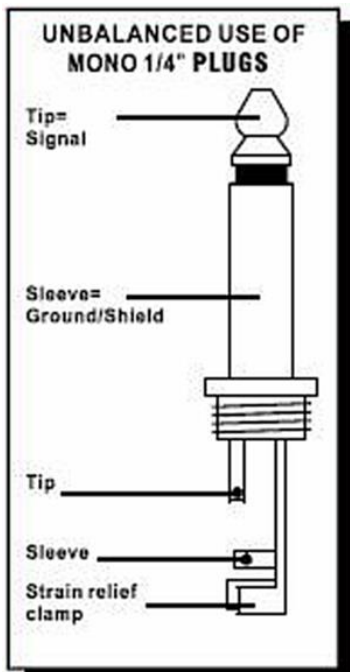
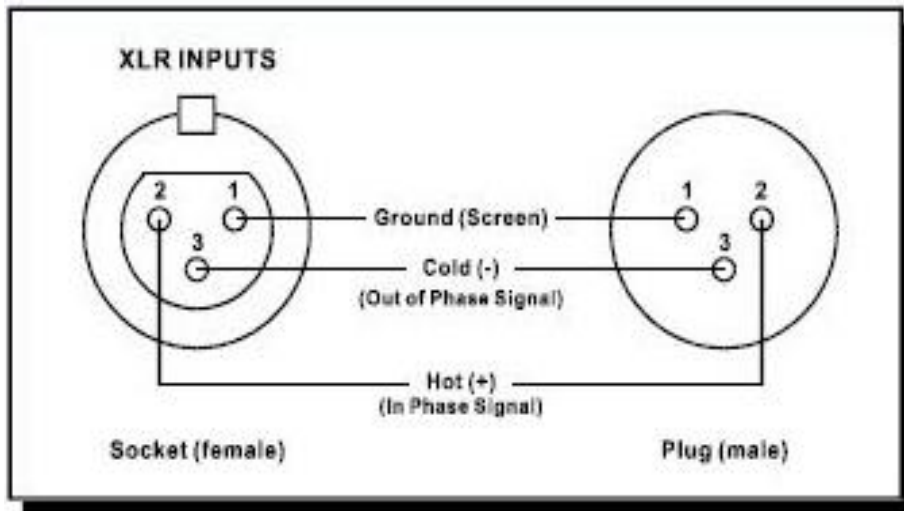

⚠ WARNING The manufacturer assumes no liability for loudspeakers that have been damaged by improper wiring, improper use of the power amplifier or by overcurrent.

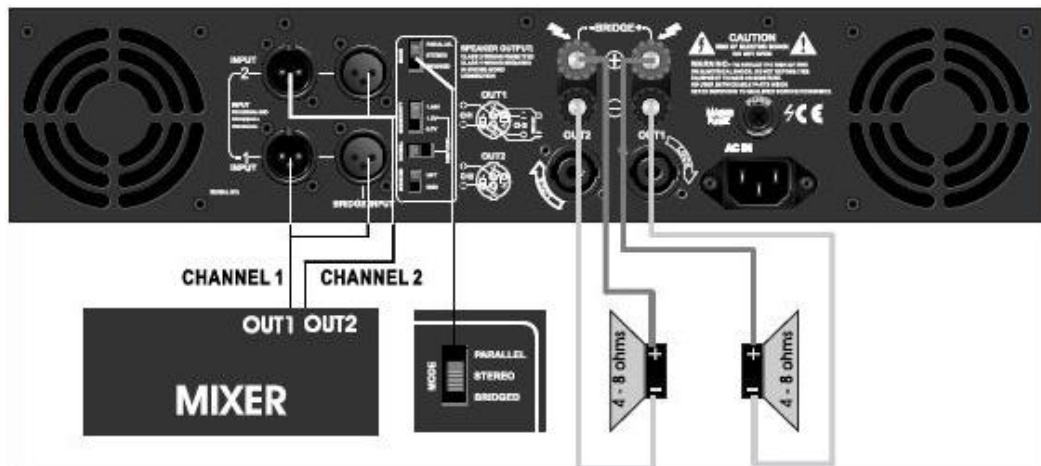
STEREO (2-CHANNEL) – MODE

1. Check if the power amplifier is switched off.
2. Set the MODE SELECTION SWITCH (16, on the back of the unit) to the middle position "STEREO".
3. Connect the input / output lines properly as shown in the illustration above.

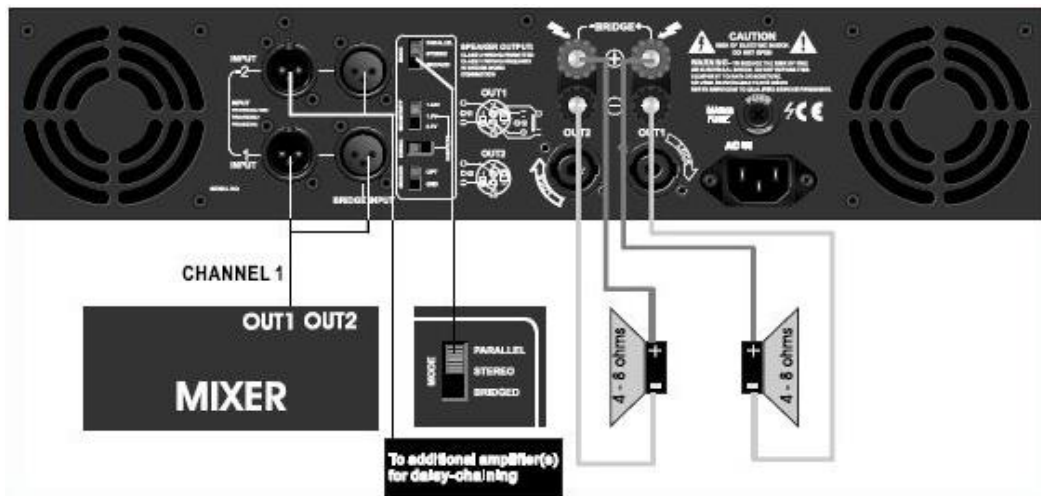
PARALLEL (MONO) –MODE

⚠ WARNING Do not use the "PARALLEL (MONO)" setting when feeding the separate signals from another power amplifier.

1. Check if the power amplifier is switched off.
2. Set the MODE SELECTOR (16, on the back of the device) to the "PARALLEL" position. The input signal from CH-1 is passed on to the input of CH-2.
3. Connect the input / output lines properly as shown in the illustration above.

BRIDGED (MONO) – MODE

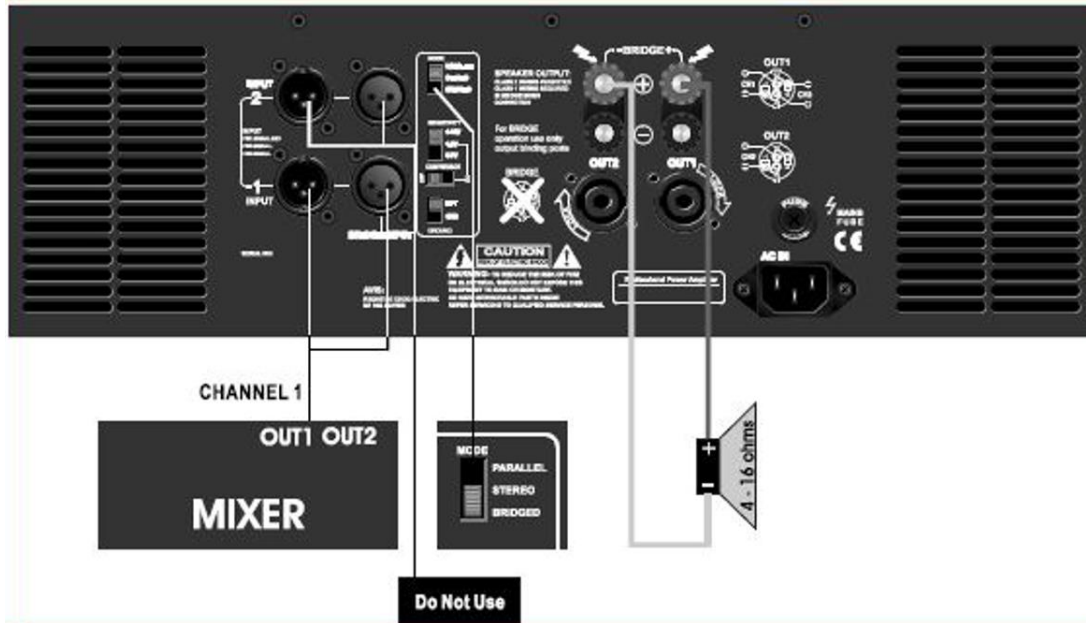

⚠ WARNING Make sure that the cabling and the loudspeaker used are suitable for this.

1. Check if the power amplifier is switched off.
2. Set the MODE SELECTION SWITCH (16, on the back of the unit) to the position "BRIDGED".
3. Connect the input / output lines properly as shown in the illustration above.

⚠ NOTE The signal will be output in CH-1.

4. Turn the volume control of channel "2" counterclockwise until it stops.

Power Amplifier TL 1200

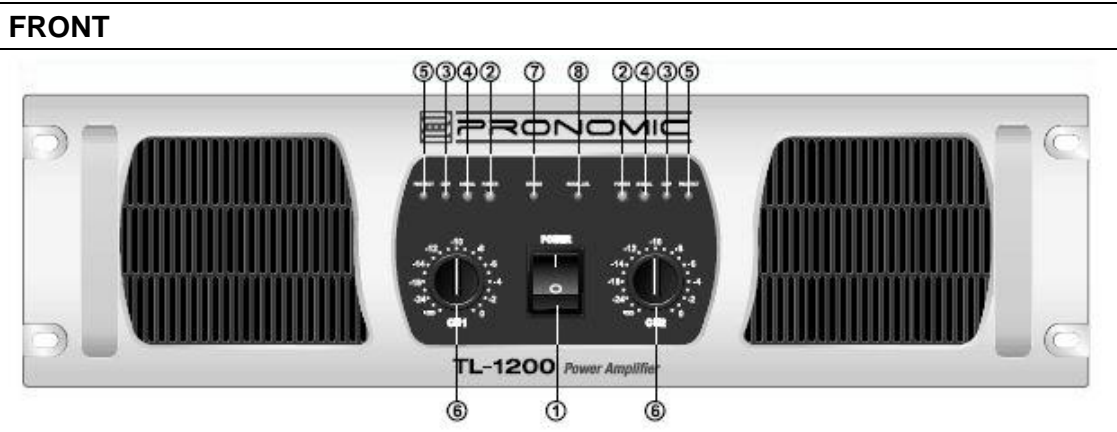
WARNING Disconnect the unit from the power supply before installation.

1. ON / OFF SWITCH

to turn the device on or off. Before turning the power amplifier on, check all connections and turn down the level controls. Temporary mute is normal when turning the power amplifier on or off.

Caution:

Always switch the power amplifier on last, after all other connected devices are switched on.

Always turn off the power amplifier before connecting any other equipment.

2. POWER LED-INDICATORS

These LEDs are lit when the power is on;

3. CLIP-LED-INDICATORS

These LEDs light up when the input level of the output stage is exceeded by 3dB (overload). When this occurs, you must either turn down the level controls on the power amp or lower the output level of the previous component so that the clip LED goes out. This avoids distortion in the sound image and prevents damage to the connected speakers.

4. SIGNAL-LED-INDICATORS

These LEDs are light up to confirm the presence of an input signal above 100mV on the channel of the power amplifier.

5. PROTECT-LED-INDICATORS

These LEDs light up when the output connection of the output stage is short-circuited, the load impedance is too low or an internal malfunction occurs. If one of these LEDs light up, switch off the power supply and check the connection of the output. Then turn on the power again.

6. LEVEL CONTROLS

to control the level of the signal that gets into each channel. The actual voltage attenuation of the power amplifier is displayed in dB. Turn these controls counterclockwise when the SIGNAL LEDs are lit steadily (indicating an excessive input signal)

7. "BRIDGED"-LED-INDICATORS

These LEDs are lit when the "BRIDGE"-MODE is set

8. "PARALLEL"-LED-INDICATORS

These LEDs are lit when the "PARALLEL"-MODE is set

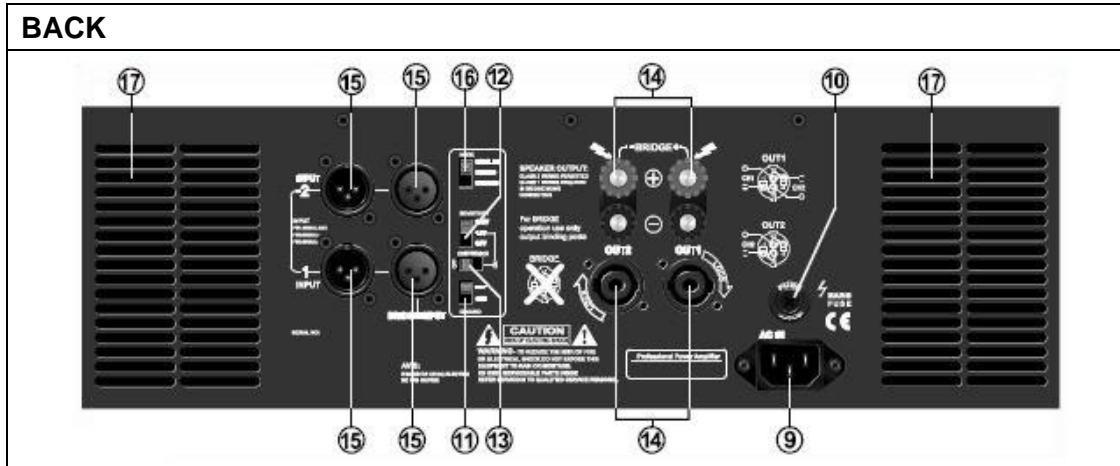

9. POWER-CONNECTOR

The connector is used to connect the amplifier to a power source.
CAUTION: Only operate the device with the supplied cold device cable

10. FUSE

Fuse holder for 5A-15A / 250V fuses. If these fuses blow repeatedly, turn off the device and have it serviced by qualified service personnel

11. GROUND LIFT SWITCH

Turn on the switch to disconnect the device from the ground, if necessary, to eliminate "humming" by ground loops;

12. SENSITIVITY SELECTOR SWITCH

This switch is used to make the amplifier suitable for different input levels. 0,7V means that the amplifier reaches full output power when 07V is input. 1,0V means that the amplifier reaches full output power when 1,0V is input and so on. 1,0V can meet the requirements of most audio equipment. Only select 0,7V or 1,44 under special condition, such as when the signal is particularly weak or large

13. COMPRESSOR SELECTOR SWITCH

The TL series power amplifiers offer 2 settings: OFF or COMPRESSOR. This switch is the choice of compressor on and off. So whatever at any sensitivity, it is recommended to use compressor to avoid clipping.

14. UR CHANNEL OUTPUTS

The connections are described under the model name.

15. INPUT CONNECTORS (XLR)

The XLR connector is equipped with balanced inputs. Symmetrical connections between the devices are recommended as they are less susceptible to AC hum. For long cable runs, an output impedance of the source of less than 600 ohms is required to avoid signal loss. Use the inputs for CH-1 and CH-2 for stereo operation (two-channel). Use only the CH-1 input for parallel or bridged mono operation. (See the user guide below for more information).

16. MODE SELECTION SWITCH

The TL series amplifiers offer three modes of operation: PARALLEL, STEREO and BRIDGED. Set the switch to one of the three positions as needed.

17. VENTILATION OPENINGS

The fan speed is automatically varied to maintain the correct internal operating temperature.

PARALL-MODE (MONO) - In this mode, both channels can be operated in parallel with the same signal without the need for a Y-cable. In this mode, the inputs for both channels are internally connected, so you only need to feed one signal into one of the channels. This further allows independent level control for each channel. It also allows for easy "Daisy-Chaining" with other power amplifiers by using the other channel of the input terminals.

 **NOTE** Do not select parallel mode if you supply the power amplifier with 2 separate signals.

 **NOTE** Do not use unbalanced and balanced cables at the same time, otherwise hum may occur.

STEREO-MODE - This is the most commonly used mode and allows independent control of two separate signals, such as stereo playback, main and monitor live mix, and bi-amp operation (highs in one channel and lows in the other).

BRIDGED-MODE (MONO) - This mode combines the power of both channels to drive a single speaker. In this mode, the power amplifier generates 4 times peak power and 3 times continuous power in a 4 or 8 Ω speaker, as each channel can deliver separately in stereo or parallel mode.

 **WARNING** In this mode, the power amplifier can power a loudspeaker with high power. Make sure the speaker, connectors, and cabling are adequate for performance. Please note that with a 4-ohm loudspeaker, the mains fuse can blow during prolonged overload. Check that the power amplifier is not overloaded when setting this mode. Connect the input signal to the CH-1 input to bypass the mono operation.

The following instructions describe the most common ways to build the power amp into a sound system.

⚠ WARNING Turn off the power amplifier before making the connections.

The TL series power amplifiers can be operated in one of three modes (stereo, bridged mono, end-parallel mono).

⚠ WARNING Observe the following wiring diagrams for connecting the loudspeakers.

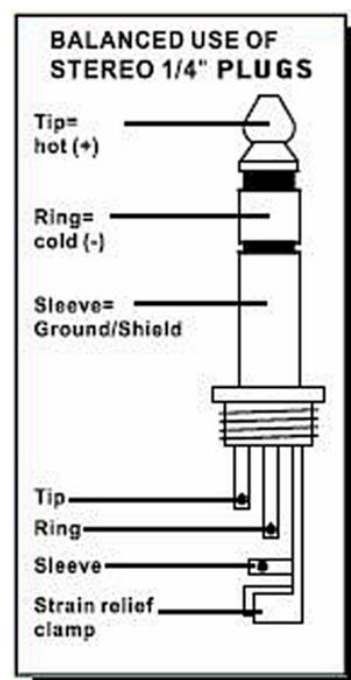
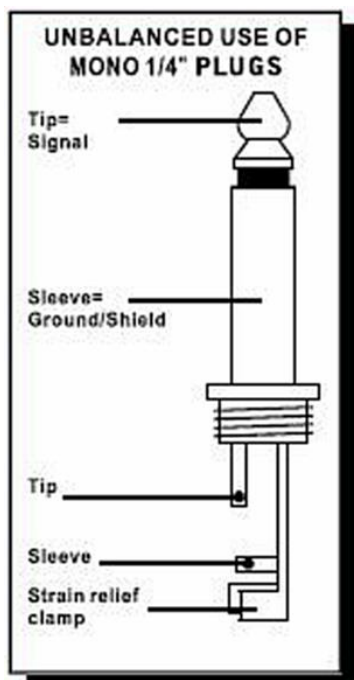
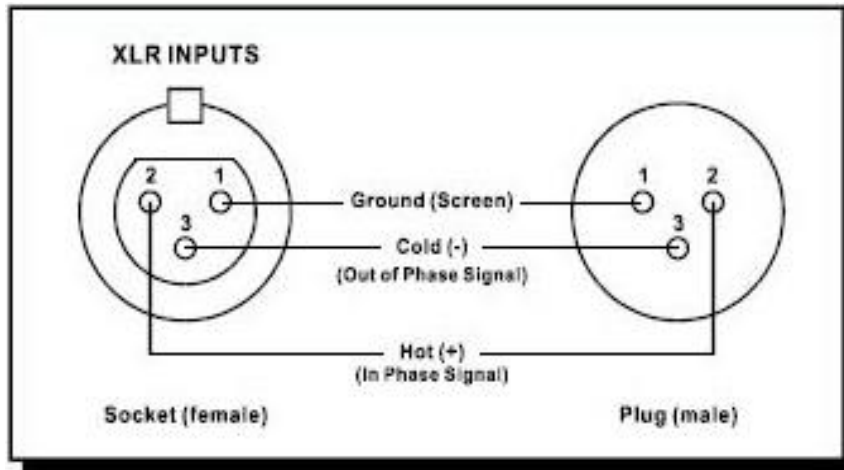

⚠ WARNING The manufacturer assumes no liability for loudspeakers that have been damaged by improper wiring, improper use of the power amplifier or overcurrent.

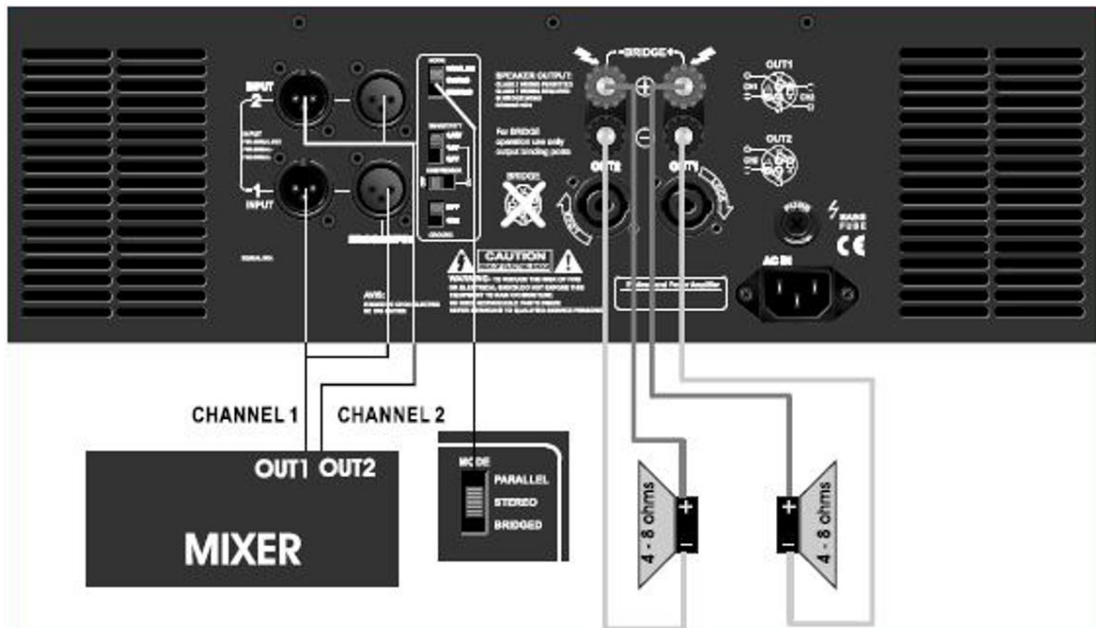
STEREO (2-CHANNEL) – MODE

1. Check if the power amplifier is switched off.
2. Set the MODE SELECTOR (16, on the back of the unit) to the middle position "STEREO".
3. Connect the input / output lines properly as shown in the illustration above.

PARALLEL (MONO) –MODE

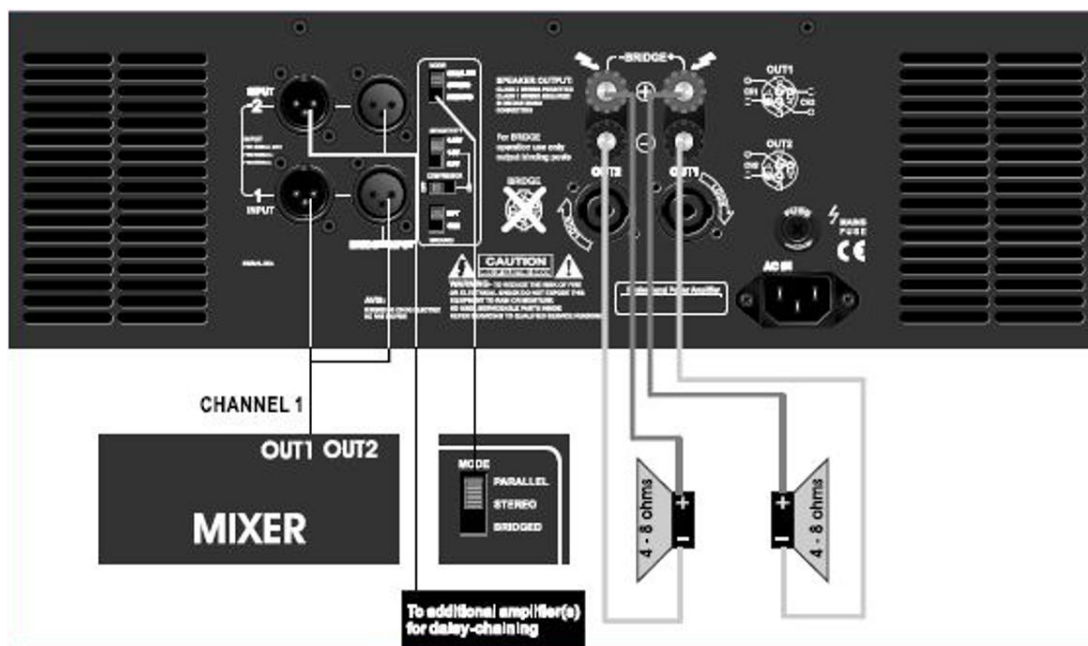

⚠ WARNING Do not use the "PARALLEL (MONO)" setting when feeding the separate signals from another power amplifier.

1. Check if the power amplifier is switched off.
2. Set the MODE SELECTOR (16, on the back of the unit) to the "PARALLEL" position.
3. Connect the input / output lines properly as shown in the illustration above.

BRIDGED (MONO) – MODE

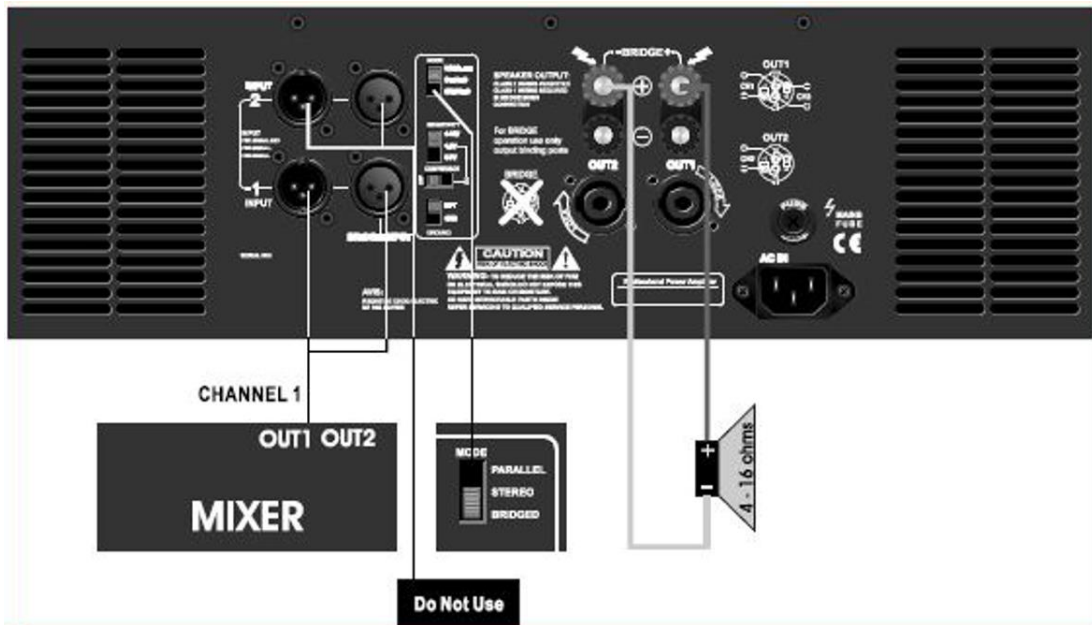

⚠ WARNING Make sure that the cabling and the loudspeakers used are suitable for this

1. Check if the power amplifier is switched off.
2. Set the MODE SELECTION SWITCH (16, on the back of the unit) to the position "BRIDGED".
3. Connect the input / output lines properly as shown in the illustration above.

⚠ NOTE The signal will be output in CH-1.

4. Turn the volume control of channel "2" counterclockwise until it stops.

Block Diagram

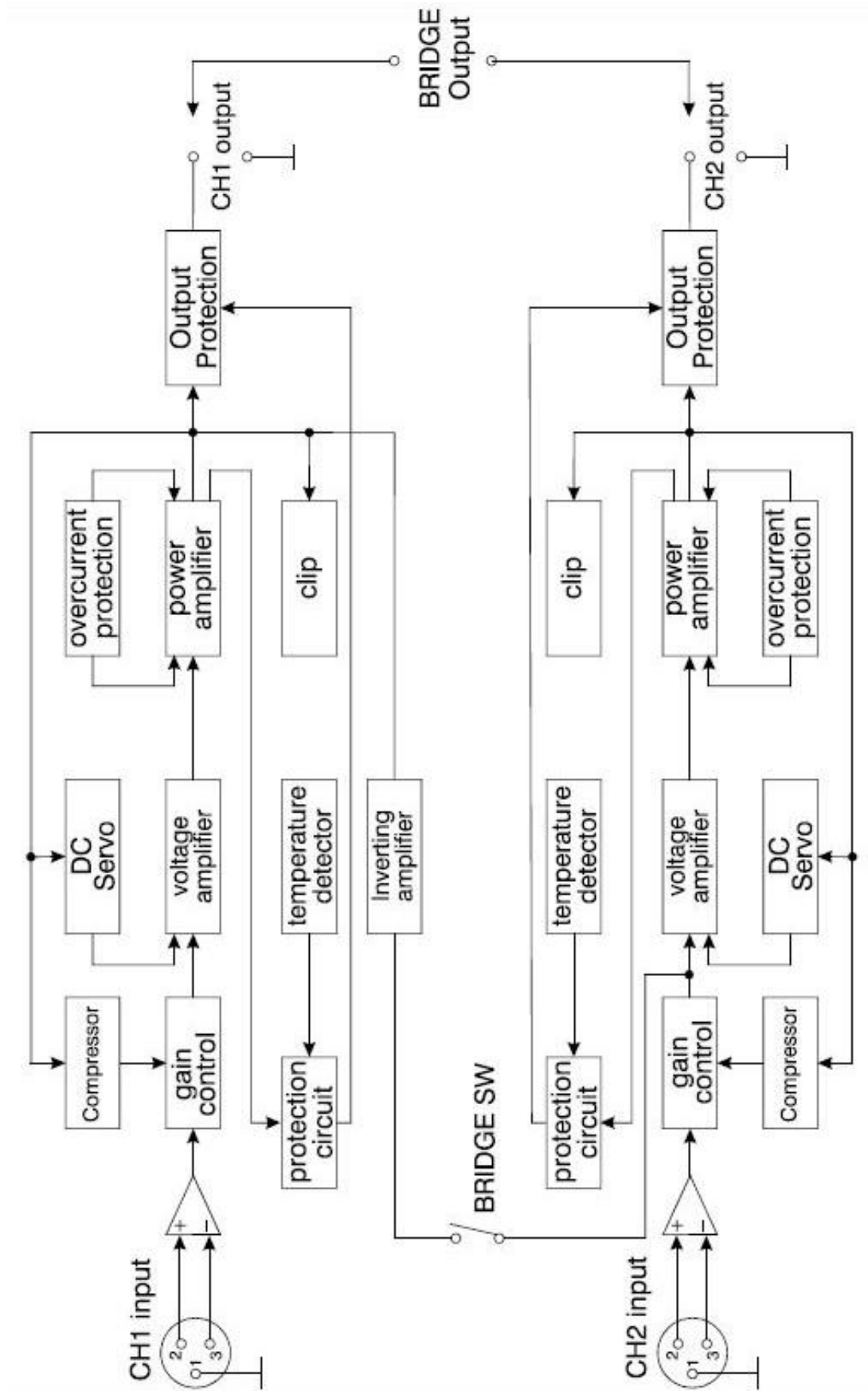

Specifications

MODEL CHARACTERISTIC	TL200	TL400	TL700	TL1200
Out Power (8 Ohm)	2x200W	2x400W	2x700W	2x1200W
Out Power (4 Ohm)	2x300W	2x700W	2x1200W	2x1000W
Out Power (2 Ohm)	2x500W	2x1000W	2x1600W	2x2400W
Out Power(BRIDGE) (80)	650W	1250W	2050W	3000W
Out Power(BRIDGE) (4Ω)	950W	1700W	2750W	4000W
FREQUENCY RESPONSE @ Half Pwr	15Hz - 25KHz(+0/-1dB)			
THD+Noise @ 1KHz Full Pwr	<0.03%		<0.035%	
IntD 60Hz & 7KHz,4:1	<0.038%		<0.04%	
SIGNAL TO NOISE RATIO	>102dB		>105dB	
SLEW RATE (input filter limited)	40V/uS			
DAMPING FACTOR 1Khz@B ohm	>400:1			
INPUT SENSITIVITY	SELECTABLE (0.77V / 1.0V / 1.44V)			
INPUT IMPEDANCE	10K ohm Balanced to ground			
INPUT CONNECTORS	Female XLR-3 & 6.35mm TRS Jack			
OUTPUT CIRCUIT TYPE	Class AB		Class H	
OUTPUT CONNECTORS	4 Pole SPEAKON & Binding posts			
PROTECTIONS	Full short-circuit Open-circuit, Thermal, Soft-start, DCvoltage, Sub/Ultrasonic and RF			
LED INDICATORS (per channel)	Bridge, Parallel, Power, Signal, Clip, Protect			
PANEL CONTROLS	FRONT-2 input attenuators REAR- Ground lift, mode selection, compressor			
COOLING	Front-to-Back via 2 variable-speed fans			
POWER SUPPLY VOLTAGE	230V AC/50Hz			
POWER SUPPLY FUSE(250)	5A	8A	15A	20A
DIMENSION (mm)	482 X 440 X 88.8 (2HE)			482 X 440X 132 (3HE)
N WEIGHT IG WEIGHT (Kg)	18.5/20	22.5/24	26/27.5	33/36

CLEANING & MAINTENANCE



Never immerse the unit in any liquid.

Regularly remove the dust from the inside of the device with compressed air through the ventilation openings.

SIMPLIFIED EU DECLARATION OF CONFORMITY

Herewith Musikhaus Kirstein GmbH declares that the device is in compliance with the EU directive 2014/53/EU. You can download the EC declaration of conformity for this item under download link:

http://www.kirstein.de/docs/Konformitaetserklaerung/CE_Konformitaetserklaerung_00063864.pdf

http://www.kirstein.de/docs/Konformitaetserklaerung/CE_Konformitaetserklaerung_00021732.pdf

http://www.kirstein.de/docs/Konformitaetserklaerung/CE_Konformitaetserklaerung_00021733.pdf

http://www.kirstein.de/docs/Konformitaetserklaerung/CE_Konformitaetserklaerung_00021734.pdf

WEEE Declaration (Waste of Electrical and Electronic Equipment)

Your product has been designed and manufactured using quality materials and components that are recyclable and reusable. The symbol means that your product must be disposed separately from household waste at the end of its service life.

Dispose of this equipment at your local collection point or recycling center.

Please help to protect the environment in which we all live.

All specifications and appearances are subject to change without notice. All information was correct at time of printing. Musikhaus Kirstein GmbH does not guarantee for the accuracy or completeness of any description, photograph or statement contained in this manual. Printed colors and specifications may vary slightly from product. Products from Musikhaus Kirstein GmbH are only sold through authorized dealer. Distributors and dealers are not agents of Musikhaus Kirstein GmbH and have no authority to bind Musikhaus Kirstein GmbH legally in any way.

 **KIRSTEIN.de**

Musikhaus Kirstein GmbH
Bernbeurener Str. 11
86956 Schongau – Germany

Email: info@kirstein.de
Telefon/Phone: 0049-8861-909494-0
Telefax/Fax: 0049-8861-909494-19

