

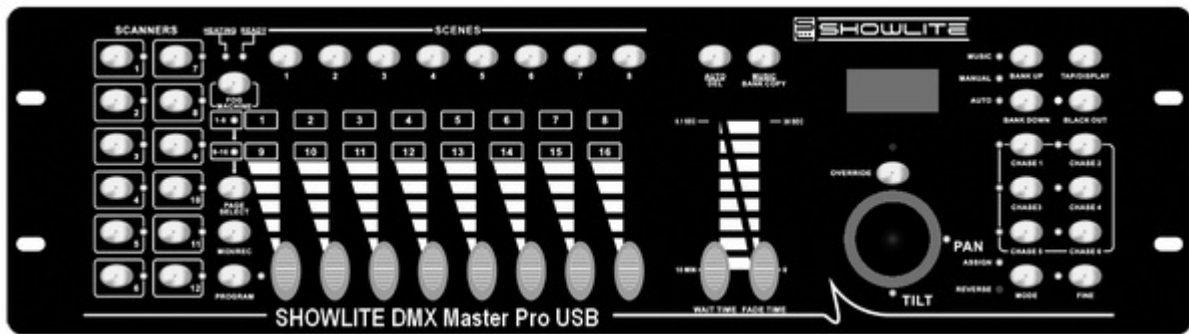

DMX Master Pro USB

Operators manual



Contents

| | |
|--|----|
| 1 Features..... | 1 |
| 2.General Instructions..... | 2 |
| 3. Panel description..... | 3 |
| 3.1. Front view instruction..... | 3 |
| 3.2.Back Side View..... | 6 |
| 4. Operation Guide..... | 7 |
| 4.1 Program Enable..... | 7 |
| 4.2 Programming Scenes..... | 7 |
| 4.2.1 Scene Editing..... | 9 |
| 4.2.2 Scene Copy..... | 10 |
| 4.2.3 Delete a Scene..... | 10 |
| 4.2.4 Delete all Scenes..... | 11 |
| 4.2.5 Bank Copy..... | 11 |
| 4.2.6 Lamps Copy..... | 12 |
| 4.3 Programming Edit..... | 12 |
| 4.3.1 Program a bank of scenes into a Program..... | 12 |
| 4.3.2 Add a Step..... | 13 |
| 4.3.3 Delete a Step..... | 14 |
| 4.3.4 Delete a Program..... | 14 |
| 4.3.5 Delete all the program..... | 15 |
| 4.4 Assign/Reverse DMX channel..... | 15 |
| 4.4.1 Assign DMX channel..... | 15 |
| 4.4.2 Reverse DMX channel..... | 16 |
| 4.4.3 Pacing model select..... | 17 |
| 4.4.4 Delete Assign/Reverse DMX channel..... | 17 |
| 4.4.5 Delete all Assign/Reverse DMX channel..... | 17 |
| 4.4.6 Check Assign/Reverse DMX channel..... | 18 |
| 4.4.7 Set up starting up display information..... | 18 |
| 4.5 Running Scenes..... | 18 |
| 4.5.1 Manual Mode..... | 18 |
| 4.5.2 Auto Mode..... | 19 |
| 4.5.3 Music Mode..... | 19 |
| 4.6 Running Chases..... | 20 |
| 4.6.1 Manual Mode..... | 20 |
| 4.6.2 Auto Mode..... | 20 |
| 4.6.3 Music Mode..... | 21 |
| 4.7 MIDI Operation..... | 21 |
| 4.7.1 MIDI Operation..... | 21 |
| 4.7.2 Controller MIDI form..... | 22 |
| 4.8 USB function..... | 22 |
| 4.8.1 Data write in USB-Stick by USB..... | 22 |

Contents

| | |
|--|----|
| 4.8.2 Reading the USB-Stick data by USB..... | 23 |
| 4.8.3 Software promotion by USB..... | 23 |
| 4.9 RMD operation..... | 24 |
| 4.10 Set off Operation..... | 26 |





1. Features

1. 192 DMX512 channels.DMX512 standard singal output
2. Controlled 12 lights,each light 16 channels.
3. 30 banks of 8 programmable scenes
4. 6 chases of 240 programmed scenes from banks
At most 20 times of every program when opened.
5. Data will be displayed by LCD
6. Voice sensitive can be adjusted
7. 8 channels or 16 channels for each light
8. DMX channel can reversed ,DMX data can change to percent mode
and numerical mode display
9. The scanners under control by Pan and Tilt jog wheels
10. Sliding channel can set up X/Y mode or all channel mode
11. MIDI control over banks, chases and Blackout
12. Machinery can be controlled
13. DMX polarity select
14. Power failure memory
15. Use RDM to Remote control DMX address
16. All the data can be copy by U disk ,also can control the software
promotion by it
17. Support FAT 16/32 file layout





2. General instruction

Please read the user manual carefully, as it includes important information regarding details of operation, maintenance, and technical data. Keep this manual with the unit for future consult

WARNINGS

-  **DO NOT** make any inflammable liquids, water or metal objects enter the unit.
-  **Should any liquid be spilled on the unit, DISCONNECT the power supply to the unit immediately.**
-  **STOP** using the unit immediately In the event of serious operation problems and either contact your local dealer for a check or contact us directly.
-  **DO NOT** open the unit--there are no user serviceable parts inside.
-  **NEVER** try to repair the unit yourself. Repairs by unqualified people could cause damage or faulty operation. Contact your nearest dealer.

CAUTIONS

-  **After having removed the packaging check that the unit is NOT damaged in any way. If in doubt, DON'T use it and contact an authorized dealer**
-  **Packaging material (plastic bags, polystyrene foam, nails, etc.) MUST NOT be left within children's reach, as it can be dangerous.**
-  **This unit must only be operated by adults. DO NOT allow children to tamper or play with it**
-  **NEVER use the unit under the following conditions:**
 - In places subject to excessive humidity.**
 - In places subject to vibrations or bumps.**
 - In places with a temperature of over 45 C/113 F or less than 2 C/35.6 F.**
 - Protect the unit from excessive dryness or humidity (ideal conditions are between 35% and 80%).**
-  **DO NOT** dismantle or modify the unit.

3. Panel description

3.1. Front view instruction

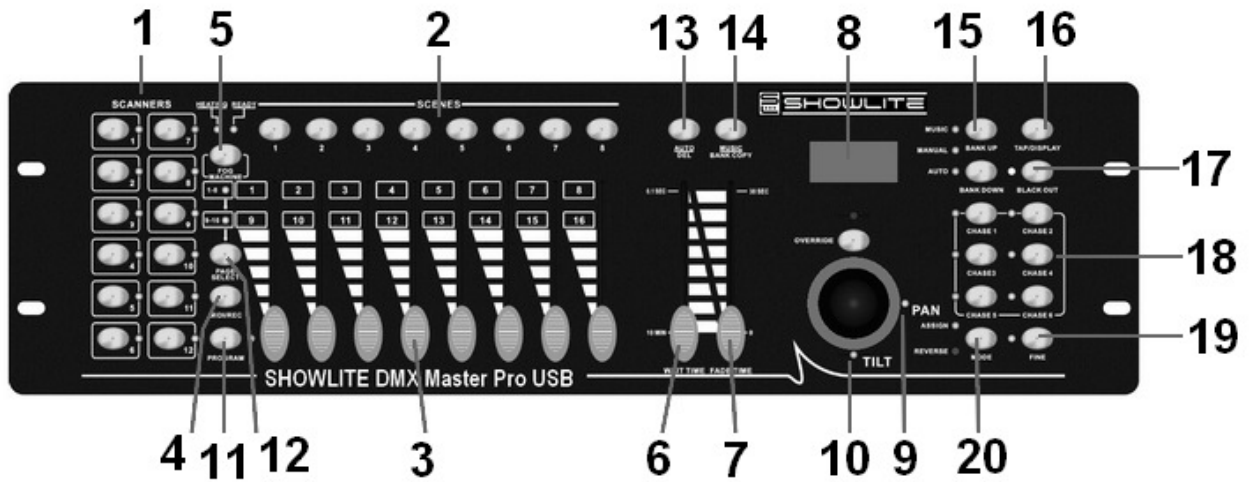

1. Scanner Buttons (1-12)

3

12 scanners of 16 DMX channels & fader control :

| Scanners | DMX channels | Fader control | LED |
|----------|--------------|---------------|--------|
| 1 | 1-16 | On/Off | On/Off |
| 2 | 17-32 | On/Off | On/Off |
| 3 | 33-48 | On/Off | On/Off |
| 4 | 49-64 | On/Off | On/Off |
| 5 | 65-80 | On/Off | On/Off |
| 6 | 81-96 | On/Off | On/Off |
| 7 | 97-112 | On/Off | On/Off |
| 8 | 113-128 | On/Off | On/Off |
| 9 | 129-144 | On/Off | On/Off |
| 10 | 145-160 | On/Off | On/Off |
| 11 | 161-176 | On/Off | On/Off |
| 12 | 177-192 | On/Off | On/Off |

Press a scanner button to turn on manual fader control. Press the scanner button again to turn off fader control. The LED besides the button lights or goes out to indicate this selection.

2. Scene Buttons

Press the scene buttons to load or stored your scenes.
There are a maximum of 240 programmable scenes.

3. Faders

These faders are used to control the intensity of channel 1-8 or channel 9-16 depending upon the selected page.

4. Page Select Button

Used to select page between Page A(1-8) and Page B(9-16).

5. Fog Machine Button

Activates Fog Machine

6. Speed Slider

Used to adjust the chase speed within the range of 0.1 second to 10 minutes.

7. Fade Time Slider

Used to adjust transition time from one scene to another scene within the range of 0 seconds to 30 seconds

8. LCD Display

Shows the current activity or programming state.

9. Pan

This jog wheel is used to control the pan of the fine turning

10. Tilt

This jog wheel is used to control the Tilt of the fine turning

11. Program Button

Activates Program mode

12. MIDI/Rec

Used to control MIDI operation or to record programs

13. Auto/Del

Activates Auto mode or to delete scenes or chases

14. Music/Bank Copy

Activates Music mode or to copy a bank of scenes

15. Bank Up/Down

Press the Up/Down button to select from 30 banks

16. Tap/Display

Used to create a standard beat or to change the value mode between 0-255.

17. Blackout

Tap to momentarily pause whole output.hold on this button enter Stand alone

18.Chase Buttons(1-6)

These buttons are used for activating the chase of programmed scenes.

19. Fine Button

When Fine is on, the Pan or Tilt wheel will control the scanner more exactly

20. Mode Button

Pressing Fine and Mode buttons allows to activate Assign or Reverse mode

2. Back Side View

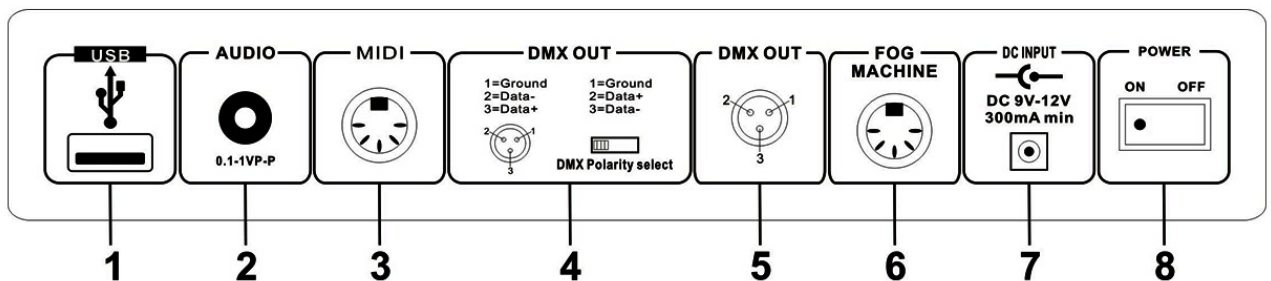

- | | | |
|-----|---------------------|--------------------------------------|
| 1 . | USB | USB port |
| 2 . | AUDIO IN | 0.1...1 Vp-p |
| 3 . | MIDI IN | Receives MIDI data |
| 4 . | DMX Polarity Select | Used to select DMX polarity |
| 5 . | DMX OUT | DMX SINGAL OUTPUT |
| 6 . | FOG MACHINE | Connector to plug in the Fog Machine |
| 7 . | DC INPUT | DC 9 -12V, 300mA min |
| 8 . | POWER | Turn on/off the power |

3. Fog machine diagram

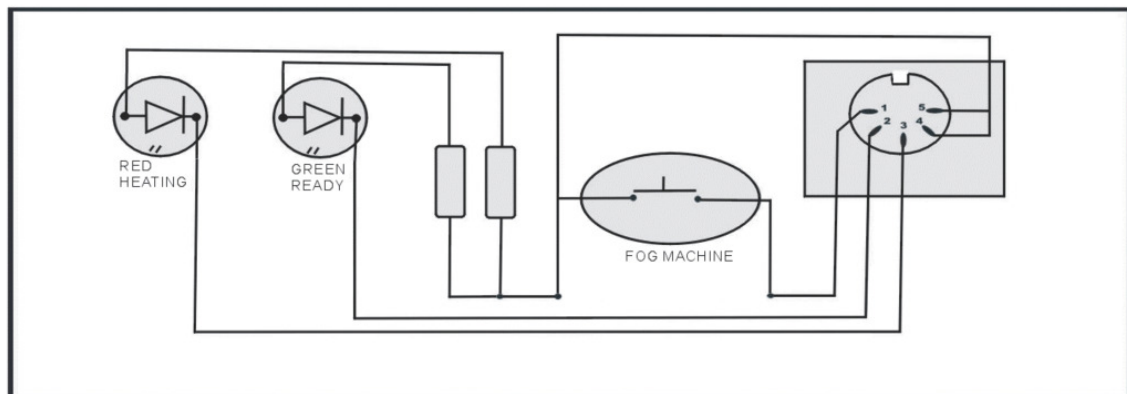

4. Operation Guide

General:

This unit allows you to program 12 scanners of 16 DMX channels, 30 banks of 8 programmable scenes, 6 chases of 240 programmed scenes using 8 faders and other function buttons. Data will be dumped on U disk and software promotion by USB port ,also has RDX function ,remote DMX address.

Display Information

The LCD Display contains a maximum of 2x8 characters

LCD Display

Message

| | |
|-----------|--|
| CHASE5 | Chase 5 is activated. |
| STEP006 | The 6th step of a chase |
| DATA 168 | DMX numerical value(000-255) |
| WT:2M18S | The current Wait Time is 2 minute and 18 seconds |
| TP:5.58S | The time of the last two taps is 558 seconds |
| FT:11.6S | Fade Time is 11.6 seconds |
| ASS 07 08 | Assign DMX channels 7 and 8 |
| RES 02 03 | Reverse DMX Channels 2 and 3 |
| SN6 | Scene 6 |
| BK 08 | Bank 08 |

4.1 Program Enable

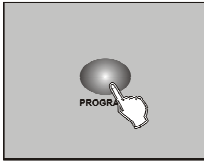

Press the Program button for three seconds to activate Program mode, the LED near to this button lights indicating Program in active.

4.2 Programming Scenes

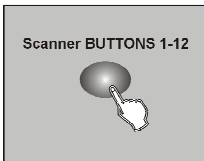

1. Enter Program mode
2. Press the Scanner button to turn on its fader control 1-12, which is indicated by the lit LED

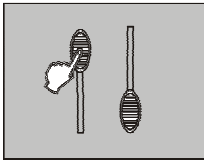

3. Move the faders to select your desired dimmer intensity if you are using a dimmer; You can also use the two jog wheels to control the Pan or Tilt movement of the scanner

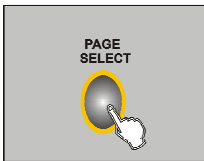

4. Change the DMX 1-8 or 9-16 channel by PAGE button
PAGE A indicated by the lit LED when 1-8 channel
PAGE B indicated by the lit LED when 9-16 channel

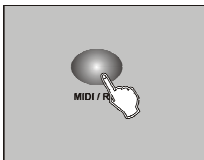

5. Once the scene is satisfactory, tap the MIDI/Rec button to program this scene into memory;

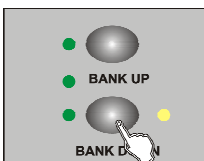

6. Tap the Bank Up/Down button to select the bank you want to store your scene into

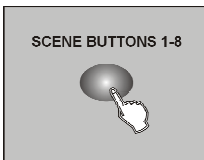

7. Tap the Scene button 1-8 to store your scene, all LEDs indicated will flicker expecting the 2 frog machines

8. Repeat steps 3-7 operation will edit other effect

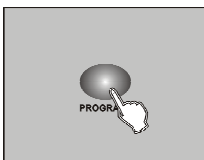

9. If you don't intend to continue your programming, press and hold down the Program button for three seconds to exit Program mode

EXAMPLE: Program 8 scenes with channel 1-8 at full in sequence into bank 3 and assign these scenes to scanner 1.

1. Program enable;
2. Tap the Scanner 1 button to turn on its fader control;
3. Change the DMX 1-8 or 9-16 channel by PAGE button, and push the scene effect;
4. Tap the MIDI/Rec button;
5. Select bank 3 using Bank Up/Down button;
6. Tap the Scene 1-8 button to store the scene;
7. Repeat steps 3-6 and store other 7 scene;
8. Tap the Scanner 1 button again to turn off its fader control;
9. Press the Program button for 3 seconds to exit Programming mode

4.2.1 Scene Editing

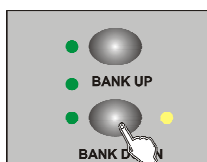

1. Program enable;
2. Tap the Bank Up/Down button to select the bank that contains the scene you wish to edit;

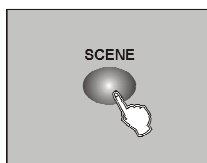

3. Select the scene you want to edit by tapping its Scene button;

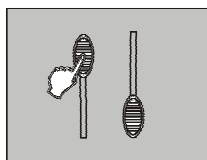

4. Use the Faders or jog wheels to make your desired adjustments;

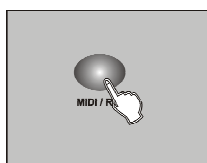

5. Once you've made your changes, tap the MIDI/Rec button;

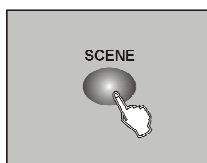

6. Tap the Scene button that corresponds to the scene you're editing. This will overwrite the exited scene.

NOTE:

Be sure to select the same scene in steps 3 and 6, otherwise you may accidentally record over an exited scene.

4.2.2 Scene copy

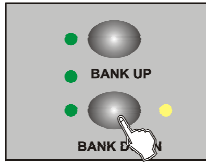

1. Program enable;
2. Tap the Bank Up/Down button to select the bank that contains the scene you wish to edit;

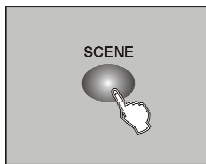

3. Select the scene you want to copy;

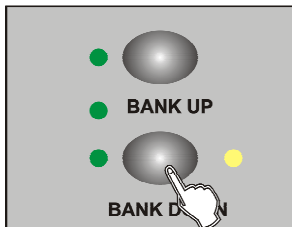

4. Tap the Bank Up/Down button to select the bank that contains the scene you wish to copy;

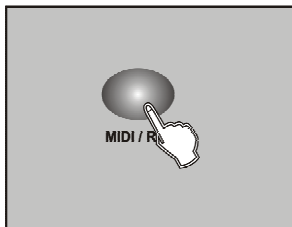

5. Tap the MIDI/Rec button;

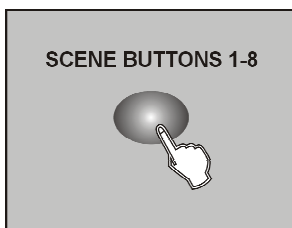

6. Tap the SCENE button, all LEDs will flicker ,copy finished.

4.2.3 Delete a scene

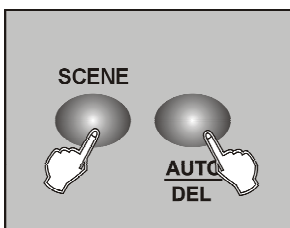

1. Program enable;
2. Tap the Bank Up/Down button to select the bank that contains the scene you wish to delete;
3. Press and hold down the Auto/Del button. Tap the Chase button which you want to delete the scene;

4. LEDS will flicker ,delete finished.

4.2.4 Delete a scene

This should be reset the controller again.

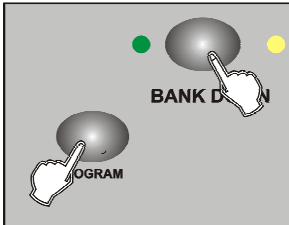

1. Turn off the power;
2. With the power off, press and hold down the Auto/Del and Bank Down buttons at the same time, about 2 seconds, all the LEDs will flicker;

3. After the LEDs flicker, all the scenes will delete.

4.2.5 BANK copy

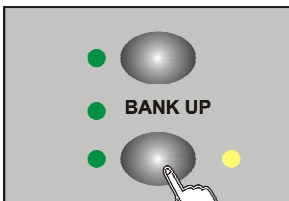

1. Program enable;
2. Tap the Bank UP/DOWN select the bank which needed copy;
3. Tap the MIDI/REC;

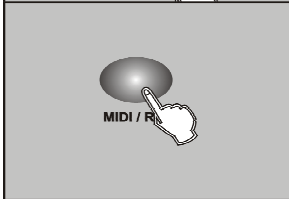

4. Tap the BANK UP/DOWN select the address which BANK copy needed;

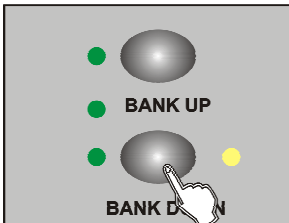

5. Tap the flicker, finish the

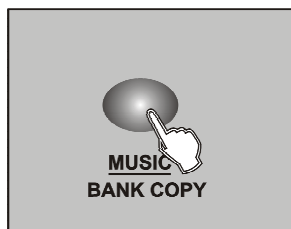

MUSIC/BANK COPY button, all the LEDs will copy

6. Press and hold on the program about 3 seconds then exit the programming.

4.2.6 Lamps copy

Copy one present lamps manual effect to another

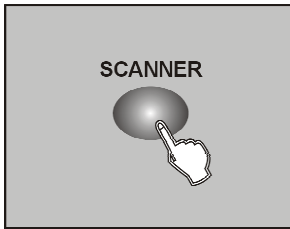

1. Press the copy SCANNER button;

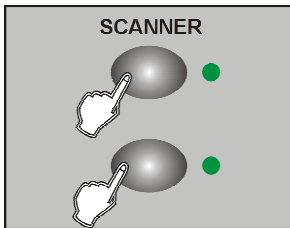

2. Tap the copy SCANNER button again, 2 lamps the output effect are the same .

4.3 Editing program

Just can edit the program after edit the scene, because program can use 30 scene of the bank, each edit can edit 240 steps at most .

1. Program enable;

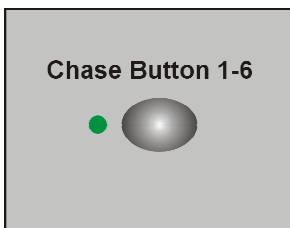

2. Select one of the chase button 1-6;

3. Select one scene from the bank;;

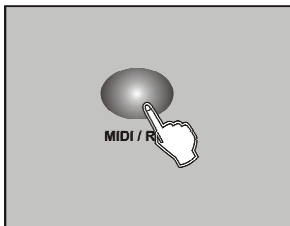

4. Tap the MIDI/REC button, all the leds flicker means enter the program;

5. Repeat the step 3.4, can edit 240 steps at most;

6. Tap an hold on PROGRAM about 3 seconds will exit the program.

4.3.1 Edit the scene to program one time from the bank

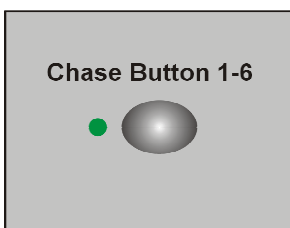

1. Program enable;

2 . Select one chase button 1-6;

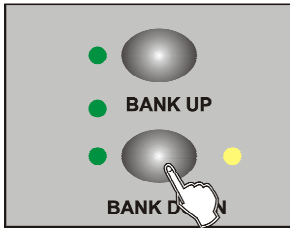

3. Select the bank by BANK UP/DOWN;

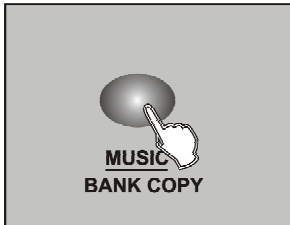

4. Tap MUSIC/BANK to copy;

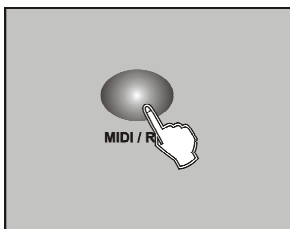

5. Tap MIDI/REC button, all the leds flicker ; 8 scenes add to program (if the bank is empty for scene , otherwise will not);

4.3.2 Add one step to the program

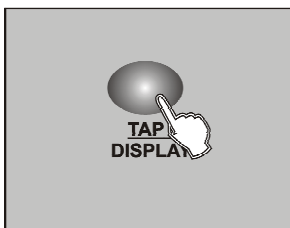

1. Program enable;
2. Select program;
3. Press the TAP button, LED switch to the present program ;

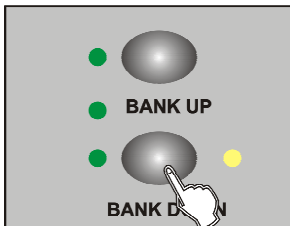

4. Tap the BANK UP/DOWN button to select the place which will needed ;

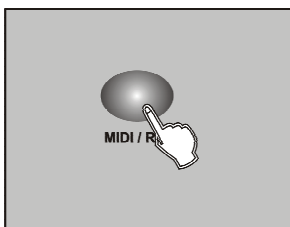

5. Tap MIDI/REC ,make sure the added step;

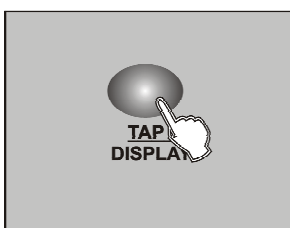

6. Press the TAP button, switch to the LED BANK and SCENE;
7. Tap bank up/down ,select the added scene;

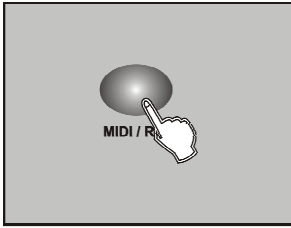

8. Tap the MIDI/REC button,all the leds flicker means the scene add to the program.

TIPS:

If you want to insert one step between 3 and Switch to the 3 step by BANK UP/DOWN ,press MIDI/REC button ,LED display “STEP 004”;

Notice:

Press Tap button ,change LED display mode (BANK mode and Step mode).

4.3.3 Delete one program step

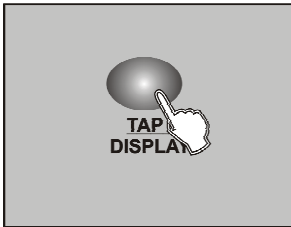

1. Program enable;
2. Select the delete program;
3. Tap the TAP button LCD will display the present step
4. Tap the BANK UP/DOWN button,select the step which needed delete;

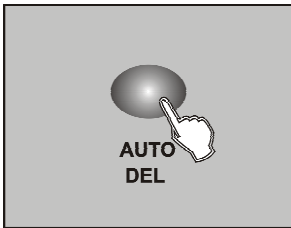

- 5 . Tap AUTO/DEL button ,delete LED display present step,all the LEDS flicker ,delete succeed.

4.3.4 Delete one program

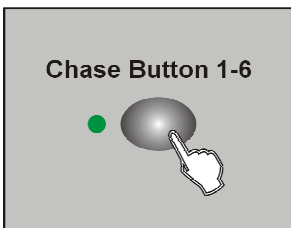

1. Program enable;
2. Open the program which needed delete;

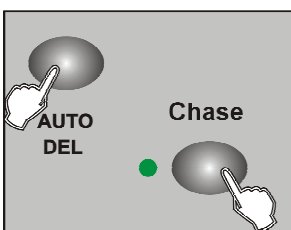

3. Press and hold on AUTO/DEL button,tap the deleted program again,all the LEDS flicker means program delete.

4-3.5 Delete all the program.

Need to reset the controller.

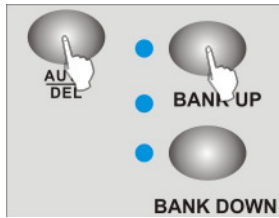

1. Turn off the power;
2. Press and hold on the AUTO/DEL and BANK DOWN at the same time, turn on the power, after about 2 seconds all the LEDs flicker;
3. All the LEDs stop to flicker, all the program delete.

4.4 Channel assign and reverse

Press Mode and Fine button at the same time can switch assign and revise mode

4.4.1 Channel Assign

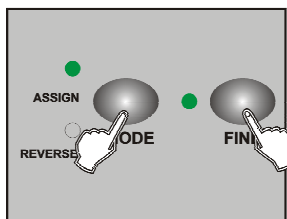

1. Program enable;
2. Press and hold on Mode and Fine button, Reverse LED indicating light up, enable reverse mode, hold on this 2 button at the same time again switch to the assign mode, Assign LED indicating light up;

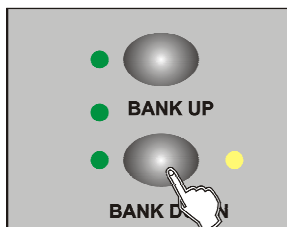

3. Tap the Bank Up/Down button select Pan or Tilt assign, Relevant LED indicating light up;

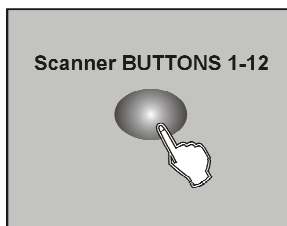

4. Select SCANNER button which needed assign lamp;

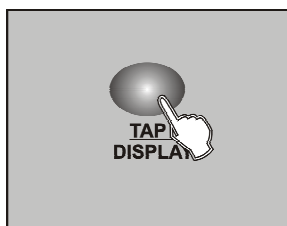

5. Tap the TAP button set up the light 8 channel or 16 channel mode;

| |
|----------|
| ASSXX XX |
| X/Y 08CH |

| |
|----------|
| ASSXX XX |
| X/Y 16CH |

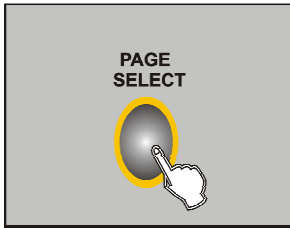

6. Page select channel located page (PAGE A/B);

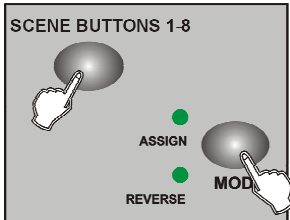

7. Press and hold on Mode button firstly, then tap the relevant assign SCENE BUTTON 1-8 button, all the indicating flicker, assign succeed, (this time SCENE 1 BUTTON correspond DMX channel 1, SCENE 2 button correspond DMX channel 2, and so on);

8. Repeat operate step 3-7, assign other SCANNER, under channel 8 mode, 12 lights can assign 48 DMX channel at most; under channel 16 mode, 12 lights can assign 24 DMX channel at most.

4.4.2 Reverse channel

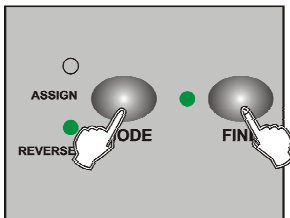

1. Program enable;
2. Press and hold on the Mode and Fine button at the same time, Reverse LED indicating light up, enable reverse mode;

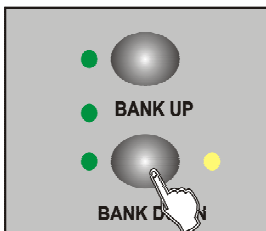

3. Select Pan or Tilt reverse, relevant by bank Up/Down button, LED indicating light up;

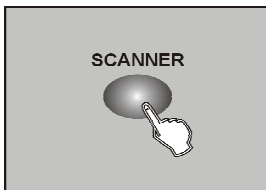

4. Select SCANNER button which needed assign;

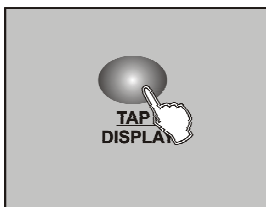

5. Tap the TAP button setup the 8 channel or 16 channel mode;

| | |
|----------|----------|
| RECXX XX | RECXX XX |
| X/Y 08CH | X/Y 16CH |

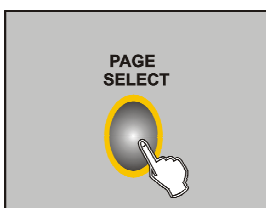

6. Page select channel located page (PAGE A/B);

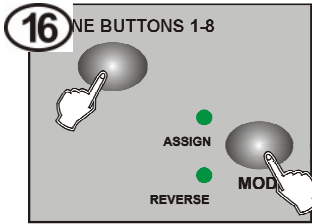

7. Press and hold on Mode button firstly, then tap the relevant assign SCENE BUTTON 1-8 button, all the indicating flicker, assign succeed, (this time SCENE 1 BUTTON correspond DMX channel 1, SCENE 2 button correspond DMX channel 2, and so on);

8. Repeat operate step 3-7, assign other SCANNER, under channel 8 mode, 12 lights can assign 48 DMX channel at most; under channel 16 mode, 12 lights can assign 24 DMX channel at most.

4.4.3 Glide mode select

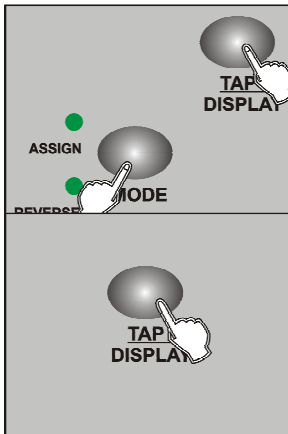

1. Turn off the power;
2. Press and hold on the MODE and TAP button at the same time, then turn on the power, about 2 seconds enable the slide mode

3. Tap the TAP button switch to slide mode (all the DMX channel slide or just X/Y channel slide)
LCD display as follows:



4. Press and hold on MODE and TAP button again at the same time, all the indicating flicker, save succeed, controller auto reset up.

4.4.4 Delete channel assign and reverse

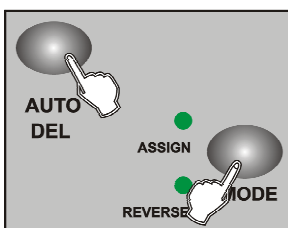

1. Program enable;
2. Press the MODE and FINE button at the same time, select assign and reverse;
3. Tap SCANNER 1-12 select lamps;

4. Press AUTO /DEL button, then tap mode button, can delete channel assign and reverse.

4.4.5 Delete all the channel assign and reverse

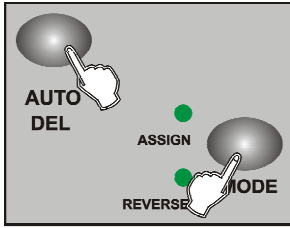

- 1 . Turn off the power ;
- 2 . Press and hold on AUTO and MODE ;
- 3 . LEDS indicating stop flicker,controller will be auto reset up ,all the assign and reverse will be deleted.

4.4.6 Examine the assign and reverse

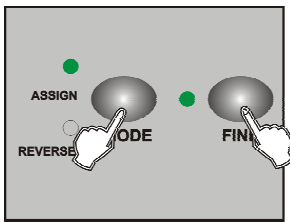

1. Press and hold on MODE and FINE ,enter to examine reverse mode;
2. Press and hold on MODE and FINE button again, examine assign mode;

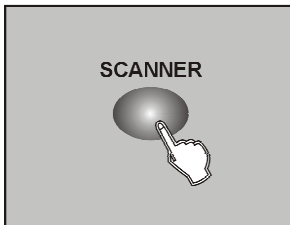

3. Tap SCANNER 1-12 ,select the light which needed examine,LCD will display assign and reverse information.

4.4.7 Staring up display information

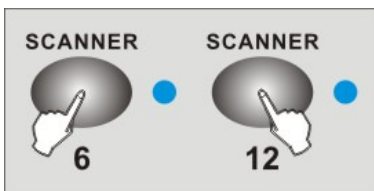

1. Turn off the power ;
- 2 . Press and hold on SCANNER 6 and 12 button at the same time ,open the controller power about

2 seconds ,SCANNER 6 and 12 LEDs indicating, enter set up condition;

- 3.Tap SCANNER 6 and 12 adjust the location of the LCD cursor;
- 4.Select character by BANK UUP/DOWN button
5. Repeat step 3 and 4 ,set up needed information

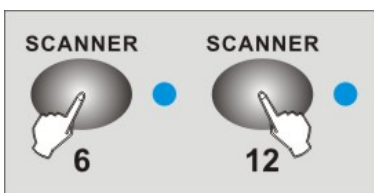
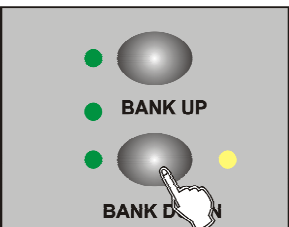

- 6.Press SCANNER 6 and 12 button at the same time , all the indicating light flicker ,save it ,controller auto reset up

4.5 Operate scene

4.5.1 AUTO mode

1. Controller opened will enter Manual condition every time;
2. MANUAL CONDITION indicating light on;
3. Tap BANK UP/DOWN button ,select the bank which the scene located;
4. Tap SCENE 1-8 ,open the scene.

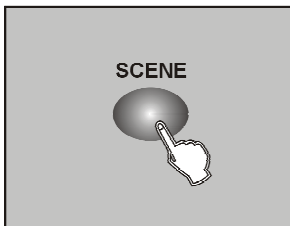

4.5.2 AUTO mode

Under AUTO mode ,the scene of the bank will circular flow in turn.

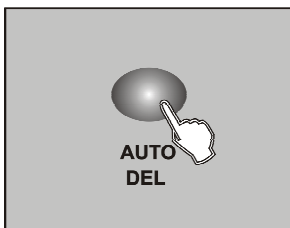

1. Tap AUTO/DEL ,AUTO indicating light on,enter AUTO mode;

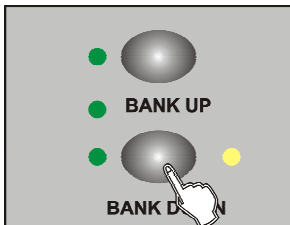

2. Tap BANK UP/DOWN ,switch bank ,select scene;

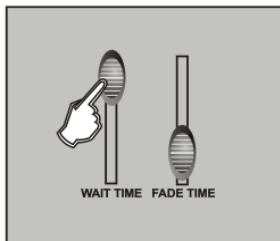

3. Adjust WAIT TIME puncher (or Tap button) and FADE TIME puncher to control the time of scene;

4. Press AUTO/DEL button ,AUTO indicating light off,back to Manual mode.

Notice:

Tap TAP button take the time ,the two TAP distant time as the scene run time.

4.5.3 Voice control

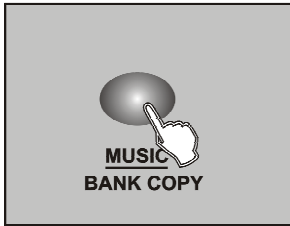

1. Tap the MUSIC /BANK COPY button, Music indicating light on enter music mode ;

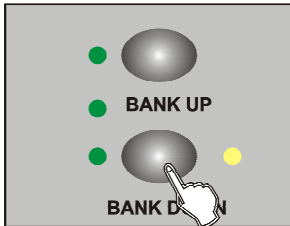

2. If need to adjust sensitivity of voice control ,can press and hold on:MUSIC/BANK COPY (LCD display voice sensitivity percentage);
 3. Use FADE TIME pusher to glide time of edit scene;
 4. Tap MUSIC /BANK COPY button,MUSIC indicating light off,back to AUTO mode;

4.6 Working procedure

Must have edit program before running

4.6.1 Manual MODE

1. Controller opened will enter Manual condition every time;
2. Open the program needed, controller will run according to the sequence;
3. FADE TIME PUNCHER to adjust the program time;
4. Tap BANK UP/DOWN to select run program previous step and next step.

4.6.2 AUTO MODE

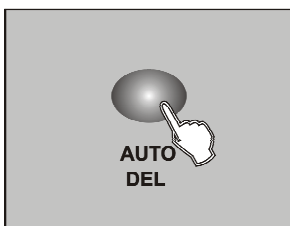

1. Tap AUTO /DEL button, AUTO indicating light on,enter MUTO mode;

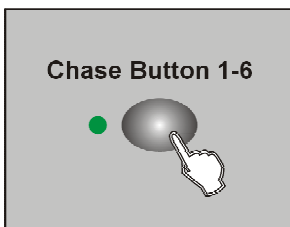

2. Open the program needed, controller will run according to the sequence;

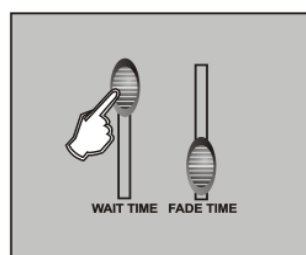

3. Adjust WAIT TIME puncher (or Tap button) and FADE TIME puncher to control the time of operation and sliding;

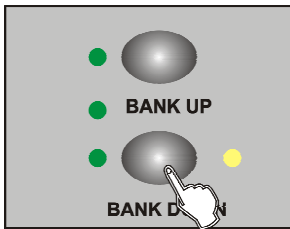

4 . Indicating light flicker at the program present,at this time ,adjust the times of cycling (at most 20 times)by BANK UP/DOWN ;

5. Tap the AUTO/DEL button ,AUTO indicating light off,back to the AUTO mode.

4.6.3 Voice mode

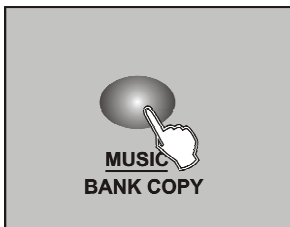

1. Tap MUSIC/BANK COPY button, MUSIC indicating light on, enter voice mode;

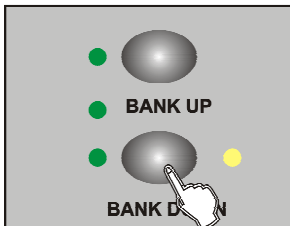

2. If need to adjust sensitivity of voice control , can press and hold on:MUSIC/BANK COPY, tap the BANK UP/DOWN again can adjust sensitivity of voice control (LCD display voice sensitivity percentage);

3. Use FADE TIME pusher to glide time of the program ;

4. Can open many program , controller will run according to the sequence;

5. Tap MUSIC/BANK COPY button, MUSIC indicating light off,back to AUTO mode.

4.7 MIDI channel setting

4.7.1 MIDI channel setting

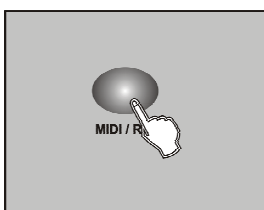

1. Press and hold on MIDI/REC about 3 seconds , LCD display the last time;

| |
|------------------|
| MIDI 01 XX XX |
|------------------|

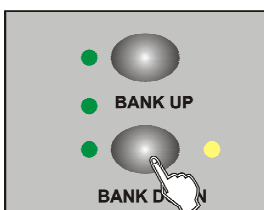

2. Set up the address of the MIDI by BANK UP/DOWN;

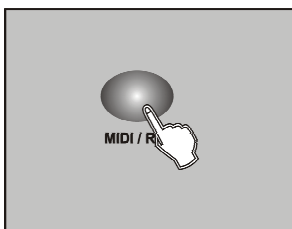

3. Press and hold on MIDI /REC button, save setting up saved and exit .

4.7.2 MIDI form

This unit receives Note On signals, which enables to run 15 banks(01-15) of scenes and 6 chases of scenes. In addition, blackout function can be activated by MIDI signal.

| BANK OR CHASE | NOTE NUMBER | ON OR OFF |
|---------------|-------------|--------------------------------------|
| Bank 1 | 00 to 07 | Turn on or off Scenes 1-8 of Bank 1 |
| Bank 2 | 08 to 15 | Turn on or off Scenes 1-8 of Bank 2 |
| Bank 3 | 16 to 23 | Turn on or off Scenes 1-8 of Bank 3 |
| | | |
| Bank 14 | 104 to 111 | Turn on or off Scenes 1-8 of Bank 14 |
| Bank 15 | 112 to 119 | Turn on or off Scenes 1-8 of Bank 15 |
| Chase 1 | 120 | Turn on or off Chase 1 |
| Chase 2 | 121 | Turn on or off Chase 2 |
| Chase 3 | 122 | Turn on or off Chase 3 |
| Chase 4 | 123 | Turn on or off Chase 4 |
| Chase 5 | 124 | Turn on or off Chase 5 |
| Chase 6 | 125 | Turn on or off Chase 6 |
| Blackout | 126 | |

4.8 USB FUCTION

Save, read data and controller software development by USB port .

4.8.1 Write the data to USB-Stick by USB

must make the USB-Stick to the USB port!

1. Press and hold on AUTO/DEL ,tap BANK UP button ,LCD display the selected file;

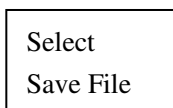

2. 12 piece button of the SCANNER indicating light on ,means U disk relevant file;
3. Tap the button which needed to save file on the U disk;
4. LCD display the selected file and the plan;

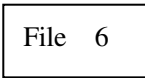

5. If succeed ,LCD will display FILE SAVE OK (failed will display WRITE FAIL) and AUTO exit .

Notice:

If don not connect USB-Stick ,LCD will display “NO USB DISK ”,Read ,write on the USB-Stick and disk software development ,please don not turn off the power or insert,move the USB-Stick, otherwise will damage your USB-Stick.

4.8.2 Read the USB-Stick data by USB

Must make the USB-Stick insert to the USB port !

1. Press and hold on AUTO/DEL button, tap the BANK DOWN button, LCD will display selected file;

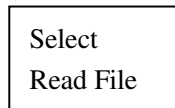

2. 12 piece button of the SCANNER indicating light on ,means U disk relevant file;
3. Tap the button which needed to read file ;

4. LCD display the selected file and the plan;

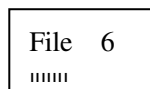

5.If succeed ,LCD will display FILE SAVE OK (failed will display WRITE FAIL) and AUTO exit .

Notice:

If don not connect USB-Stick ,LCD will display “NO USB DISK ”,Read ,write on the U disk and disk software development ,please don not turn off the power or insert,move the U disk, otherwise will damage your U disk.

4.8.3 Software update by USB

Gaining the software update file from our website or supplier , and copy it to U

disk (PRO1612J please put the file to pro-1612j , PRO1612W please put the file to pro-1612w).

1. Put the U disk to USB mouth;
2. Press and hold on scanner1,scanner2 and scene3,turn on the power at the same time ,LCD display," ANY KEY UPDATE"(any button can update),(if you don not insert the U disk ,LCD will display 'NO DISK',you an insert the U disk again);
3. Press any button can update software ;
4. After updating ,LCD will display 'UPDATE OK';
5. Turn off the power ,update succeed.

4.9 RMD operate

Before you operate it must make sure the equipment has RDM!

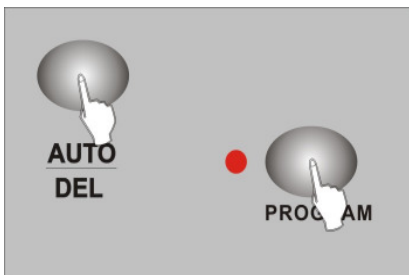

- 1 . Under the no program condition ,press and hold on AUTO/DEL button ,tap PROGRAM button,will enter scan condition,LCD will display the data;



- 2 . After scan succeed will display the quantity of the equipment (at most 100 piece one time);

| | | | |
|----------------------|----------------------|------------------------|----------------------|
| DISCOVER Count001 | DISCOVER Count002 | DISCOVER Count..... | DISCOVER Count100 |
|----------------------|----------------------|------------------------|----------------------|

3. Scan failed will display 'NO FOND,FIXTTURE', and AUTO exit RDM;



- 4 . After scan, controller will AUTO select one equipment, let it examine .LCD will display the DMX address and new address; .

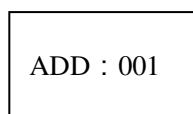

- 5 . To select the fixture for DMX address setting, move the joystick or

rotate the rolling wheels;

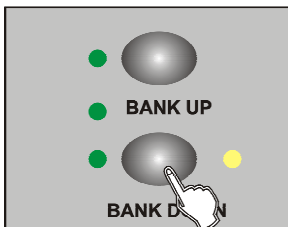
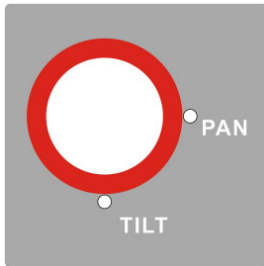

6 . Adjust the new DMX address by BANK UP/DOWN button, or directly tap SCANNER BUTTONS 1-12 and PAGE button AUTO join the DMX address;

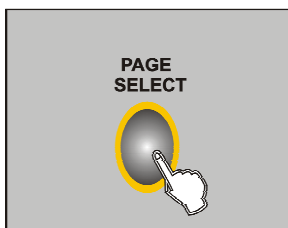
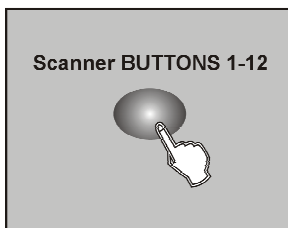

DMX and SCANNER button:

| SCANNER BUTTONS 1-12 | PAGE A/B | DMX 地址 |
|----------------------|----------|--------|
| SCANNER1 | PAGE A | DMX001 |
| | PAGE B | DMX009 |
| SCANNER 2 | PAGE A | DMX017 |
| | PAGE B | DMX025 |

| | | |
|------------|--------|--------|
| SCANNER 3 | PAGE A | DMX033 |
| | PAGE B | DMX041 |
| SCANNER 4 | PAGE A | DMX049 |
| | PAGE B | DMX057 |
| SCANNER 5 | PAGE A | DMX065 |
| | PAGE B | DMX073 |
| SCANNER 6 | PAGE A | DMX081 |
| | PAGE B | DMX089 |
| SCANNER 7 | PAGE A | DMX097 |
| | PAGE B | DMX105 |
| SCANNER 8 | PAGE A | DMX113 |
| | PAGE B | DMX121 |
| SCANNER 9 | PAGE A | DMX129 |
| | PAGE B | DMX137 |
| SCANNER 10 | PAGE A | DMX145 |
| | PAGE B | DMX153 |
| SCANNER 11 | PAGE A | DMX161 |
| | PAGE B | DMX169 |
| SCANNER 12 | PAGE A | DMX177 |
| | PAGE B | DMX185 |

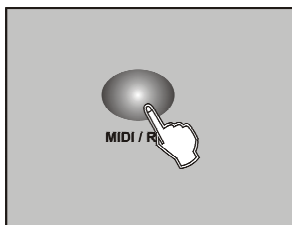

7. Set up the address ,tap the MODI/REC button, all the LEDs flicker ,the new DMX address set up succeed;

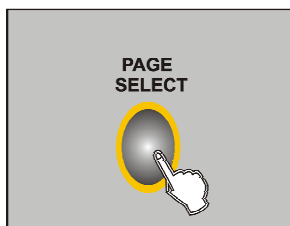

8. Repeat the 5-7 step ,set up other DMX address ;

9. Press and hold on AUTO/DEL ,tap PROGRAM button , exit RDM .

4.10 Turn off the operation condition

Turn off the operation condition means open the operation and scene or turn on /off condition will recover the before or not .(Not including the manual pusher the data).

1.Press and hold on AUTO SCENE 8 button, turn on the power,LCD display

RUN SAVE, enter operation condition;

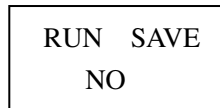

2. Tap the TAP button, select YES or NO;
3. At this time press and hold on BLACK OUT button ,will not save and exit;
4. Press and hold on AUTO SCENE8 at the same time ,all the LEDs flicker , means setting up succeed.

TIPS:

When you set up on/off condition ,the scene and program will keep at least 7 seconds and reset up the before condition;

Suggest use this function can open it .

If you have any suggestions when you use this product please

**tell me .Welcome to feedback to us from our website or suppliers les us
make the product more perfect.**

| | |
|----------------------|-----------------------------------|
| Power Input | DC 9V, 300 mA min. |
| DMX output | 3 pin male XLR |
| USB | USB-A |
| MIDI Signal | 5 pin standard interface |
| Audio Input | By built-in microphone or line in |
| Dimensions | 482x134x73mm |
| Weight(appro.) | 2.0 kg |

WEEE Erklärung - WEEE declaration

Ihr Produkt wurde mit hochwertigen Materialien und Komponenten entworfen und hergestellt, die recycelbar sind und wieder verwendet werden können. Dieses Symbol bedeutet, dass elektrische und elektronische Geräte am Ende ihrer Nutzungsdauer vom Hausmüll getrennt entsorgt werden müssen. Bitte entsorgen Sie dieses Gerät bei Ihrer örtlichen kommunalen Sammelstelle oder im Recycling Center. Bitte helfen Sie mit, die Umwelt, in der wir leben, zu erhalten.

Technische Änderungen und Änderungen im Erscheinungsbild vorbehalten. Alle Angaben entsprechen dem Stand bei Drucklegung. Für die Richtigkeit und Vollständigkeit der enthaltenen Beschreibungen, Abbildungen und Angaben übernimmt Musikhaus KIRSTEIN GmbH keinerlei Gewähr. Abgebildete Farben und Spezifikationen können geringfügig vom Produkt abweichen. Musikhaus KIRSTEIN GmbH - Produkte sind nur über autorisierte Händler erhältlich. Distributoren und Händler sind keine Handlungsbevollmächtigten von Musikhaus KIRSTEIN GmbH und haben keinerlei Befugnis, die Musikhaus KIRSTEIN GmbH in irgendeiner Weise, sei es ausdrücklich oder durch schlüssiges Handeln, rechtlich zu binden. Diese Bedienungsanleitung ist urheberrechtlich geschützt. Jede Vervielfältigung, bzw. jeder Nachdruck, auch auszugsweise, und jede Wiedergabe der Abbildungen, auch in verändertem Zustand, ist nur mit schriftlicher Zustimmung der Firma Musikhaus KIRSTEIN GmbH gestattet.

Your product is designed and manufactured with materials and components of high quality, which are recyclable and can be reused. The symbol means that your product should be disposed of separately from household waste when it reaches its end of life. Please dispose of this equipment at your local collection point or recycling center. Please help to protect the environment in which we all live.

All specifications and appearances are subject to change without notice. All information was correct at time of printing. Musikhaus KIRSTEIN GmbH does not guarantee for the accuracy or completeness of any description, photograph or statement contained in this manual. Printed colors and specifications may vary slightly from product. Products from Musikhaus KIRSTEIN GmbH are only sold through authorized dealer. Distributors and dealers are not agents of Musikhaus KIRSTEIN GmbH and have no authority to bind Musikhaus KIRSTEIN GmbH legally in any way. This manual is protected by copyright. Any copying or reprint, even in excerpts, is only allowed with written consent of Musikhaus KIRSTEIN GmbH. The same applies to reproduction or copying of images, even in altered form.



Musikhaus KIRSTEIN GmbH – Bernbeurener Strasse 11 – D-86956 Schongau – Tel. 0049-8861-909494-0

Flood Light Panel LED 5x9W RGB



Bedienungsanleitung / Users manual

Einleitung:

Herzlichen Dank,

dass Sie sich für das **Showlite Flood Light Panel** entschieden haben.

Wir wünschen Ihnen viel Spaß und Freude mit Ihrem neuen Showlite Flood Light Panel.

Bitte lesen Sie diese Anleitung aufmerksam, um die praktischen Funktionen des **Showlite Flood Light Panel** voll nutzen zu können.

Außerdem empfehlen wir Ihnen, dieses Handbuch an einem sicheren und leicht zugänglichen Ort aufzubewahren, um später darin nachschlagen zu können.



Achtung !

Vor dem ersten Einschalten und der Inbetriebnahme des Geräts lesen Sie auf Jeden Fall die Sicherheitsanweisungen durch um Verletzungen sowie Beschädigungen des Geräts zu vermeiden.

Bedienungsanleitung (deutsch) ab Seite 2

Introduction

Thank you for your purchase of the **Showlite Flood Light Panel**.

We hope that you will enjoy the use of the Showlite Flood Light Panel.

Please read through this manual carefully before beginning to use, so that you will be able to take full advantage of the **Showlite Flood Light Panel** features and enjoy trouble-free operation for years to come.

Please keep this manual at a safe and dry place where you easily can access it.



Caution !

Before switching on the instrument or device read carefully the safety instructions to avoid serious injuries or damage of the product.

Operators manual (english) -> start from page 5

Appendix 3 – Technische Daten / Technical data

| | |
|---|---|
| Typ / Type | 5 x 9 Watt LED RGB |
| Art.Nr. | 00033188 |
| Farbmischung Color Mixing | 4 in 1 / RGB mixing |
| Spannungsversorgung Power Supply | 100-240V - 50/60Hz |
| Leistungsaufnahme Power consumption | 50 Watt |
| Betriebstemperatur Operating temperature | -20° ... 40° |
| Abstrahlwinkel angle of radiation | 25° |
| Anschlüsse Connectors | DMX in/out (XLR) Power In/Out |
| DMX channels | 3 / 6 DMX channel modes |
| Dimmer | 0 ... 100% |
| Sound Control | eingebautes Mikrofon built in microphone |
| Zubehör accessories | Anschraubbare Füße, Netzkabel adjustable stands, net cable |
| Abmessungen (BxHxT) Dimensions (WxHxD) | 225 mm x 220mm x 85mm |
| Gewicht Weight | 1.5 kg |

Voreingestellte Programme / Preset programmes

| Program | Funktion / | SP 1 ... SP 2 |
|---------|--|---------------|
| 1 | Farbwechsel alle Farben / chaser light all colors | 1.2 sec |
| 2 | Farbwechsel / chaser light | 0.4 sec |
| 3 | überblenden warme Farben / fading warm colors | 0.5-1.5 sec |
| 4 | überblenden kalte Farben / fading cold colors | 0.5-1.5 sec |
| 5 | Strobe warme Farben / warm color strobe | 0.1-1.0 sec |
| 6 | Strobe kalte Farben / flashing cold color strobe | 0.1-1.0 sec |
| 7 | weiches Überblenden alle Farben / smooth fading all colors | 0.3-1.3 sec |
| 8 | weißes Strobe / white strobe | 1Hz ... 15Hz |

Appendix 2 – Bedienstruktur / operator guidance chart

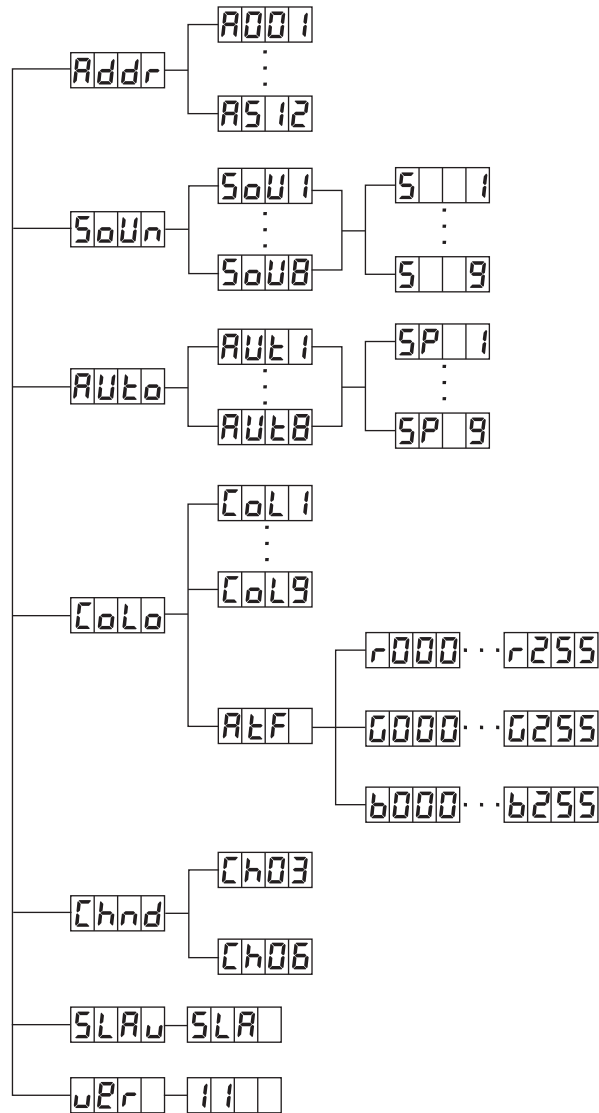

Vorsichtsmaßnahmen

BITTE SORGFÄLTIG DURCHLESEN, EHE SIE WEITERMACHEN

Warnung:

Befolgen Sie unbedingt die nachfolgend beschriebenen grundlegenden Vorsichtsmaßnahmen, um die Gefahr einer schwerwiegenden Verletzung oder sogar tödlicher Unfälle, von elektrischen Schlägen, Kurzschlüssen, Beschädigungen, Feuer oder sonstigen Gefahren zu vermeiden. Zu diesen Vorsichtsmaßnahmen gehören die folgenden Punkte, die jedoch keine abschließende Aufzählung darstellen:

Netzanschluss/Netzanschlusskabel (bei Geräten mit Netzanschluss/Netzadapter):

- Verwenden Sie ausschließlich die für das Gerät vorgeschriebene richtige Netzspannung. Die erforderliche Spannung finden Sie auf dem Typenschild des Geräts.
- Prüfen Sie den Netzstecker in regelmäßigen Abständen und entfernen Sie eventuell vorhandenen Staub oder Schmutz, der sich angesammelt haben kann.
- Verwenden Sie ausschließlich die mitgelieferten Netzkabel/Stecker.
- Verlegen Sie das Netzkabel niemals in der Nähe von Wärmequellen, etwa Heizkörpern oder Heizstrahlern, biegen Sie es nicht übermäßig und beschädigen Sie es nicht auf sonstige Weise, stellen Sie keine schweren Gegenstände darauf und verlegen Sie es nicht an einer Stelle, wo jemand darauftreten, darüber stolpern oder etwas darüber rollen könnte.
- Wenn Sie den Netzstecker aus dem Gerät oder der Netzsteckdose abziehen, ziehen Sie stets am Stecker selbst und niemals am Kabel. Wenn Sie am Kabel ziehen, kann dieses beschädigt werden.
- Ziehen Sie stets den Netzstecker aus der Netzsteckdose heraus, wenn das Gerät längere Zeit nicht benutzt wird oder während eines Gewitters.
- Schließen Sie das Gerät niemals mit einem Mehrfachsteckverbinder an eine Steckdose an. Hierdurch kann sich die Tonqualität verschlechtern oder sich die Netzsteckdose überhitzen.

Batteriebetrieb (bei Geräten mit Batterie):

- Vermischen Sie keine alten und neuen Batterien – verwenden Sie nur Qualitätsprodukte
- Versuchen Sie nicht, nicht-wiederaufladbare Batterien aufzuladen
- Achten Sie beim Wechseln der Batterien auf die am Gerät gekennzeichnete Polarität..
- Schließen Sie die Batterien nicht kurz, nehmen Sie diese nicht auseinander, erhitzen Sie die Batterien nicht und werfen Sie die Batterien nicht ins Feuer. Batterien können explodieren und ernsthafte Verletzungen verursachen..
- Das Wechseln der Batterien sollte durch einen Erwachsenen erfolgen, lassen Sie Kinder nie mit Batterien spielen.
- Nehmen Sie die Batterien heraus wenn das Gerät längere Zeit nicht eingeschaltet wird. Dies beugt der Beschädigung durch Auslaufen der Batterie vor.
- Batterien müssen auf eine sichere, umweltschonende Weise gesondert entsorgt werden. Werfen Sie diese nicht in den Hausmüll.

Öffnen verboten:

- Versuchen Sie nicht, das Gerät zu öffnen oder Teile im Innern zu zerlegen oder sie auf irgendeine Weise zu verändern. Das Gerät enthält keine Teile, die vom Benutzer gewartet werden könnten. Wenn das Gerät nicht richtig zu funktionieren scheint, benutzen Sie es auf keinen Fall weiter!

Gefahr durch Wasser:

- Achten Sie darauf, dass das Gerät nicht durch Regen nass wird, verwenden Sie es nicht in der Nähe von Wasser oder unter feuchten oder nassen Umgebungsbedingungen und stellen Sie auch keine Behälter mit Flüssigkeiten darauf, die herausschwappen und in Öffnungen hineinfließen könnte.
- Schließen Sie den Netzstecker niemals mit nassen Händen an oder ziehen Sie ihn heraus.

Falls Sie etwas ungewöhnliches am Gerät bemerken:

- Wenn das Netzkabel ausgefranst ist oder der Netzstecker beschädigt wird, wenn es während der Verwendung des Geräts zu einem plötzlichen Tonausfall kommt, oder wenn es einen ungewöhnlichen Geruch oder Rauch erzeugen sollte, schalten Sie den Netzschalter sofort aus, ziehen Sie den Netzstecker aus der Netzsteckdose!

Montage:

• Lesen Sie unbedingt sorgfältig die mitgelieferte Dokumentation durch, die das Verfahren beim Zusammenbau beschreibt. Wenn das Gerät nicht in der richtigen Reihenfolge zusammengebaut wird, kann es beschädigt werden oder sogar Verletzungen hervorrufen.

Aufstellort:

- Setzen Sie das Gerät niemals übermäßigem Staub, Vibrationen oder extremer Kälte oder Hitze aus (etwa durch direkte Sonneneinstrahlung, die Nähe einer Heizung oder Lagerung tagsüber in einem geschlossenen Fahrzeug), um die Möglichkeit auszuschalten, daß sich das Bedienfeld verzieht oder Bauteile im Innern beschädigt werden.
- Betreiben Sie das Gerät nicht in der Nähe von Fernsehgeräten, Radios, Stereoanlagen, Mobiltelefonen oder anderen elektrischen Geräten. Anderenfalls kann durch das Gerät oder die anderen Geräte ein Rauschen entstehen.
- Stellen Sie das Gerät nicht an einer instabilen Position ab, wo es versehentlich umstürzen könnte.
- Ehe Sie das Gerät bewegen, trennen Sie alle angeschlossenen Kabelverbindungen ab.
- Stellen Sie das Gerät nicht direkt an eine Wand (halten Sie einen Abstand von mindestens 3 cm von der Wand ein), da es andernfalls aufgrund unzureichender Luftzirkulation zu einer Überhitzung des Geräts kommen kann.
- Stellen Sie keine offenen Flammen, wie z.B. Kerzen, auf dem Gerät ab. Eine offene Flamme könnte umstürzen und einen Brand verursachen.

Montage und Inbetriebnahme

Das Showlite Flood Light Panel ist geeignet als Floor-Scheinwerfer, aber auch zur Überkopfmontage auf Bühnen, in Theatern, Diskotheken, etc. Bei der Installation sind besondere Sicherheitsvorkehrungen insbesondere die Bestimmungen der **BGV C1 (vormals VBG70) und EN 60598-2-17** zu beachten. Die Installation darf nur von erfahrener Personal durchgeführt werden. Die hier gelisteten Sicherheitsvorkehrungen sind nur ein Auszug, für die sachgemäße Installation und Inbetriebnahme ist ausschliesslich der Betreiber verantwortlich.

Überkopfmontage

WICHTIG! ÜBERKOPFMONTAGE ERFORDERT EIN HOHES MASS AN ERFAHRUNG

Dies beinhaltet (aber beschränkt sich nicht allein auf) Berechnungen zur Definition der Tragfähigkeit, verwendetes Installationsmaterial und regelmäßige Sicherheitsinspektionen des verwendeten Materials und des Scheinwerfers. Versuchen Sie niemals, die Installation selbst vorzunehmen, wenn Sie nicht über eine solche Qualifikation verfügen, sondern beauftragen Sie einen professionellen Installateur. Unsachgemäße Installationen können zu Verletzungen und/oder zur Beschädigung von Eigentum führen.

Die Aufhängevorrichtungen des Scheinwerfers muss so gebaut und bemessen sein, dass sie 1 Stunde lang ohne dauernde schädliche Deformierung das 10-fache der Nutzlast aushalten kann. Die Installation muss immer mit einer zweiten, unabhängigen Aufhängung, z. B. einem geeigneten Fangnetz oder Fangseil, erfolgen. Diese zweite Aufhängung muss so beschaffen und angebracht sein, dass im Fehlerfall der Hauptaufhängung kein Teil der Installation herabfallen kann.

Der maximale Fallabstand darf 20 cm nicht überschreiten.

Ein Sicherungsseil, das einmal der Belastung durch Absturz ausgesetzt war oder beschädigt ist, darf nicht mehr als Sicherungsseil eingesetzt werden. Stellen Sie den Neigungswinkel über den Hängebügel ein und ziehen Sie die Feststellschrauben gut fest.

Appendix 1 – DMX512 channel list

3CH mode

| Channel | Value | Function |
|---------|-------|-----------------|
| CH 1 | 0–255 | Red (0%–100%) |
| CH 2 | 0–255 | Green (0%–100%) |
| CH 3 | 0–255 | Blue (0%–100%) |

6CH mode

| Channel | Value | Function |
|---------|------------------|--|
| CH 1 | 0–255 | Master dimmer (0%–100%) |
| CH 2 | 0–255 | Red (0%–100%) |
| CH 3 | 0–255 | Green (0%–100%) |
| CH 4 | 0–255 | Blue (0%–100%) |
| CH 5 | 0–255 | Adjust Strobe when CH 6<16, adjust speed when CH 6>15; |
| CH 6 | 0-15 | CH 1~CH 5 work; CH 6>15, CH 1~CH 5 not work |
| | 16-31 | Sence BG-RB-RG-B-RB |
| | 32-47 | Sence RB-R-RG-G-BG |
| | 48-63 | Sence BG-RG-RB-B-RB |
| | 64-79 | Sence BG-RB-R-null-RB |
| | 80-95 | Sence RG-R-null-B-RB |
| | 96-111 | Color sync strobe |
| | 112-127 | Color fade |
| | 128-143 | Color sync |
| | 144-159 | Up-dimming then Shuter closing |
| | 160-175 | down-dimming plus color change |
| | 176-191 | Up-dimming plus color change |
| | 192-207 | Color Up-dimming then down-dimming |
| 208-223 | Color mix change | |
| 224-239 | Run sound mode 1 | |
| 240-255 | Run sound mode 2 | |

Power connection and DMX

After save installation (floor or overhead) please connect the power cable to net voltage like listed in technical data. You can operate the lighting device by an external DMX controller or by internal preset programs. If using a DMX controller connect the controller DMX-OUT with the lighting DMX-IN. To connect several lighting effects set up a DMX loop by connecting DMX-OUT of first device with DMX-IN of second device and so on.

DMX-connectors and backside operator panel:

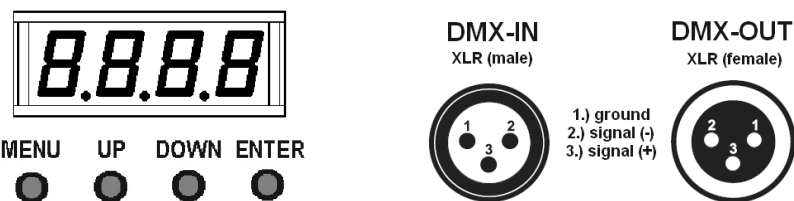

Preset Programs / parameter settings

All parameter settings and preset programs can be changed and selected on the backside operator panel. After first power on the display shows **A001** – by pressing **[ENTER]** button, the display shows selected DMX address. By pressing **[UP]/[DOWN]** you can adjust the address and save with **[ENTER]** button. Display is showing **Axxx** (**xxx** = selected DMX address).

By pressing **[UP]/[DOWN]** buttons you can select the sub menus **Auto**, **Colo**, **SoUn**, **SLAv** and **ver**. Select a menu and press **[ENTER]**, display will change to parameter menu where you can change the particular parameter settings by pressing **[UP]/[DOWN]**. Parameters can be changed and saved by **[ENTER]** button.

Preset programs:

Select **Mode** menu by pressing **[UP]/[DOWN]** and accept by pressing **[ENTER]**. Display will change to preset programs to be selected by **[UP]/[DOWN]**. By pressing **[ENTER]** you step into sub menu where you can adjust specific preset parameters (color, speed, etc.).

| | |
|-------------|---|
| Addr | DMX address setting A001 to A512 |
| Auto | 8 Auto presets – adjustable speed in 9 steps |
| SoUn | 8 Sound presets like Auto but sound controlled |
| Colo | 1..9 color mixing presets / individual RGB color mixing (Atf) |
| Chnd | Select DMX channel mode |
| SLAv | switch device to SLAVE mode |
| ver | software version is displayed |

In **Auto** mode the speed can be adjusted in 9 steps SP01...SP09. In **Sound** mode the light effect will be controlled by the built in microphone (backside).

See complete operator guidance chart in Appendix 2

Netzanschluss und DMX

Nach Beendigung der sicheren Montage (Floorbetrieb oder Überkopfmontage), verbinden Sie das Netzkabel mit der Stromversorgung. Verwenden Sie nur die für das Gerät spezifizierte Netzspannung (siehe technische Daten). Bei Verwendung mehrerer Geräte können Sie die Netzversorgung sowie die DMX-Steuerleitung über die Ein- und Ausgangsbuchsen durchschleifen. Das Gerät kann in vorinstallierten Preset-Programmen (Auto, Sound) betrieben werden oder vorzugsweise über einen DMX-Controller gesteuert werden. Hierzu wird der Controller mit einem geeigneten DMX-Kabel verbunden.

DMX-Anschlüsse und Bedienelemente auf der Geräterückseite:



Starten der Preset-Programme / Parametrierung

Über das eingebaute Display und die darunter liegenden Tasten können Sie den Scheinwerfer parametrieren und in Betrieb nehmen. Nach dem ersten Einschalten erscheint die Anzeige **Addr A001** – nach drücken der **[ENTER]** Taste erscheint die eingestellte DMX-Adresse. Mit den Tasten **[UP]/[DOWN]** kann diese angepasst und mit **[ENTER]** gespeichert werden. Die Anzeige wechselt auf **Axxx** (mit **xxx** der gewählten Adresse).

Nach Drücken des Tasters **[MENU]** können mit den Tasten **[UP]/[DOWN]** die weiteren Untermenüs **Auto**, **SoUn**, **Colo**, **SLAv** und **ver** angewählt werden. Im Untermenü gelangen Sie mit **[ENTER]** in die Einstellebene in welcher Sie die Parameter mit den Tasten **[UP]/[DOWN]** anpassen und mit **[ENTER]** speichern können.

| | |
|-------------|---|
| Addr | Einstellen der Geräteadresse von A001 bis A512 |
| Auto | 8 voreingestellte Auto Modi – Geschwindigkeit 9 Stufen |
| SoUn | 8 voreingestellte Sound (wie Auto) Modi - soundgesteuert |
| Colo | voreingestellte Farbmischung 1..9 / individuelle RGB Mischung (Atf) |
| Chnd | Auswahl DMX Betriebsart 3/6 Kanal |
| SLAv | Anwählen des SLAVE Mode |
| ver | Anzeige der Geräte-SW Version |

In den **Auto** Modi stellen sie die Effekt-Geschwindigkeit in 9 Stufen SP1..SP9 ein, in der Betriebsart **Sound** wird der Scheinwerfer über das eingebaute Mikrofon auf der Geräterückseite gesteuert.

Die Menüstruktur für die Bedienung finden Sie in Appendix 2

Precautions

Please read carefully before proceeding

Warning:

Always follow the basic precautions listed below to avoid the possibility of serious injury or even death from electrical shock, short-circuiting, damages, fire or other hazards. These precautions include, but are not limited to, the following:

Power supply / power cord (devices with power cords/power supplies):

- Only use the voltage specified as correct for the device. The required voltage is printed on the type plate of the device. Check the power cable from time to time regarding dirt, damage or other influence.
- Use only the included power cord / power supply or adaptor. Do not place the power cord near heat sources such as heaters or radiators, and do not excessively bend or otherwise damage the cord, place heavy objects on it, or place it in a position where anyone could walk on, trip over, or roll anything over it.
- Remove the electric plug from the outlet when the device is not to be used for extended periods of time, or during electrical storms. When removing the electric plug from the device or an outlet, always hold the plug itself and not the cord. Pulling by the cord can damage it.
- To avoid generating unwanted noise, make sure there is adequate distance (50 cm or more) between the AC power adaptor and the device. Do not cover or wrap the AC power adaptor with a cloth or blanket.

Batteries / safety instructions (devices with batteries):

- Use only high quality batteries – do not mix batteries with rechargeable accumulators
- Do not try to recharge non-rechargeable batteries
- Keep attention to the polarity when changing the batteries (polarity is signed on the device)
- Do not cause an electrical short at the batteries, do not open the batteries
- Changing of batteries must not be done by children, do not let children play with batteries
- Remove batteries from the device when the dDevice is not in use for a longer period
- Batteries are special waste, do not dispose them with the domestic waste

Location:

- When setting up the device, make sure that the AC outlet you are using is easily accessible. If some trouble or malfunction occurs, immediately turn off the power switch and disconnect the plug from the outlet. Even when the power switch is turned off, electricity is still flowing to the product all the minimum level. When you are not using the product for a long time, make sure to unplug the power cord from the wall AC outlet.
- Inadequate ventilation can result in overheating, possibly causing damage to the device(s), or even fire.
- Do not expose the device to excessive dust or vibrations, or extreme cold or heat (such as in direct sunlight, near a heater, or in a car during the day) to prevent the possibility of panel disfiguration or damage to the internal components.
- Do not place the device in an unstable position where it might accidentally fall over.
- Do not block the vents. This device has ventilation holes at the bottom/rear to prevent the internal temperature from becoming too high. In particular, do not place the device on its side or upside down. Inadequate ventilation can result in overheating, possibly causing damage to the device(s), or even fire.
- Do not use the device in the vicinity of a TV, radio, stereo equipment, mobile phone, or other electric devices. Doing so may result in noise, both in the device itself and in the TV or radio next to it.

Connections and handling:

- Before connecting the device to other devices, turn off the power for all devices. Before turning the power on or off for all devices, set all volume levels to minimum. • Do not use the device or headphones for a long period of time at a high or uncomfortable volume level, since this can cause permanent hearing loss. If you experience any hearing loss or ringing in the ears, consult a physician.
- Do not rest your weight on the device or place heavy objects on it, and avoid use excessive force on the buttons, switches or connectors

Do not open:

- Do not open the device or attempt to disassemble the internal parts or modify them in any way. The device contains no user-servicable parts. If it should appear to be malfunctioning, discontinue use immediately and have it inspected by qualified service personnel.

Water warning:

- Do not expose the device to rain, use it near water or in damp or wet conditions on it containing liquids which might spill into any openings. Never insert or remove an electric plug with wet hands.

If you notice any abnormality:

- If the power cord or plug becomes frayed or damaged, or if there is a sudden loss of sound during use of the device, or if any unusual smells or smoke should appear to be caused by it, immediately turn off the power switch, disconnect the electric plug from the outlet, and have the device inspected by qualified service personnel.

INSTALLATION

The Showlite Flood Light Panel is designed as floor effect or for overhead rigging on stages, in discotheques, theatres, etc. During installation consider all necessary safety instructions especially **EN 60598-2-17** and national standards. Please note: for overhead rigging in public or industrial areas, a series of safety instructions have to be considered. This manual can only give a survey and does not list complete instructions. Installation must only be done by authorized and experienced operators.

Overhead rigging

Important! Overhead rigging must only be done by authorized and experienced operators. Always install an appropriate safety bond.

You must only use safety bonds and quick links complying with DIN 56927, shackles complying with DIN EN 1677-1 and BGV C1 carabines. All devices must be sufficiently dimensioned and used correctly in accordance to the latest industrial safety regulations.

The installation of the device has to be built and constructed in a way that it can hold 10 times the weight for 1 hour without any harming deformation.

The maximum drop distance must never exceed 20 cm.

A safety bond which already held the strain of a crash or which is defective must not be used again.



 **KIRSTEIN.de**
We love music!



excellent sound

- Sauerstofffreies Kupfer
- Hochdichter Kupferschild
- Hochflexibler und robuster Außenmantel
- Handgelötet
- Säure- und ölfest
- Spannzangen und Zugentlastung
- Niedrige Leiterkapazität
- 3 Jahre Garantie
- Oxygen free copper
- High density copper shield
- Highly flexible and durable
- Soldered by hand
- Acid and oil proof
- Chuck type strain relief
- Low capacitance
- 3 years warranty



Cet appareil
se recycle

À DÉPOSER
EN MAGASIN

À DÉPOSER
EN DÉCHÈTERIE



OU



FR



Points de collecte sur www.quefairedemesdechets.fr
Privilégiez la réparation ou le don de votre appareil !